

SAR-8 SPORTER

(.308 Win)

Care, Maintenance and Operating Instructions

NOTE: Although the SAR-8 Sporter comes standard with a thumbhole stock and thread protector, all illustrations and photography herein show the SAR-8 equipped with its optional accurizing package (pistol grip, composition stock and flash suppressor). All references in this manual to the earlier SAR-3 rifle are also applicable to and interchangeable with the SAR-8 Sporter rifle.



SPRINGFIELD®
ARMORY®

The Springfield SAR-3 rifle is based on the original G3 (HK-91 type) military rifle, one of the world's most popular and reliable combat firearms. The Springfield Armory SAR-3 is a 7.62mm (.308 Cal.) semiautomatic, recoil-operated rifle employing the same delayed roller-lock locking system and fluted chamber as the original German-made G3. The SAR-3 is assembled in the USA from brand new parts jointly manufactured by an H&K licensee and Springfield Armory. Most SAR-3 parts are interchangeable with the original German imports. Each SAR-3 comes complete with an accessory package that includes two magazines, a leather sling, this technical manual, and a cleaning kit.



SAR-3 Specifications

CALIBER:	7.62mm NATO (.308 Win.)
OPERATING PRINCIPLE:	Recoil operated
LOCKING SYSTEM:	Delayed roller-lock
ACTION:	Semiautomatic only
FEEDING:	20-round box magazine
CONSTRUCTION:	Receiver-stamped; Barrel-hammer forged
RIFLING:	4-groove, right hand twist, one-turn-in-eleven
MUZZLE VELOCITY:	2,458 to 2,624 fps
OVERALL LENGTH:	Std Model-40.38" Retractable Stock Model, Stock extended-40.38" Retractable Stock Model, Stock retracted-33.1"
BARREL LENGTH:	18"
SIGHT RADIUS:	22.52"
WEIGHT:	Std Model, w/out magazine- 8.7 lbs.
SIGHTS:	Rear-Diopter rotary style with 4 adjustments (100 meter "V" sight and 200, 300, and 400 meter aperture sight); adjustable for windage and elevation
FRONT:	Protected post

SAR-3 Rifle

Exploded View and Parts List

1. Distance Sleeve for Catch
2. Elbow Spring w/Roller
3. Hammer
4. Pressure Shank for Hammer
5. Compression Spring for Hammer
6. Ejector
7. Compression Spring for Ejector
8. Trigger Housing
9. Axle for Trigger Sear & Catch
10. Axle for Hammer
11. Axle for Ejector Complete
12. Spring Ring for Ejector Axle
13. Sear
14. Trigger Bolt for Sear
15. Compression Spring for Sear
15. Clamping Sleeve for Bolt Head
17. Elbow Spring for Trigger
18. Trigger Complete
19. Butt Plate with Stop Spring
20. Butt Stock w/Holder for Buffer Housing
21. Screw for Buffer Self Locking
22. Spring Washer
23. Locking Washer
24. Back Plate Complete
25. Locking Pin Complete for Butt Stock
26. Buffer
27. Locking Washer for Buffer
28. Screw Self Locking for Buffer
29. Rivet for Stop Pin
30. Recoil Spring
31. Guide Ring for Recoil Spring
32. Stop Pin for Recoil Spring
33. Grip
34. Lens Head Cylindrical Screw
35. Toothed Washer for Grip Screw
36. Pistol Grip
37. Handguard Finished
38. Magazine Catch
39. Compression Piece for Magazine Catch
40. Contact Piece for Magazine Catch

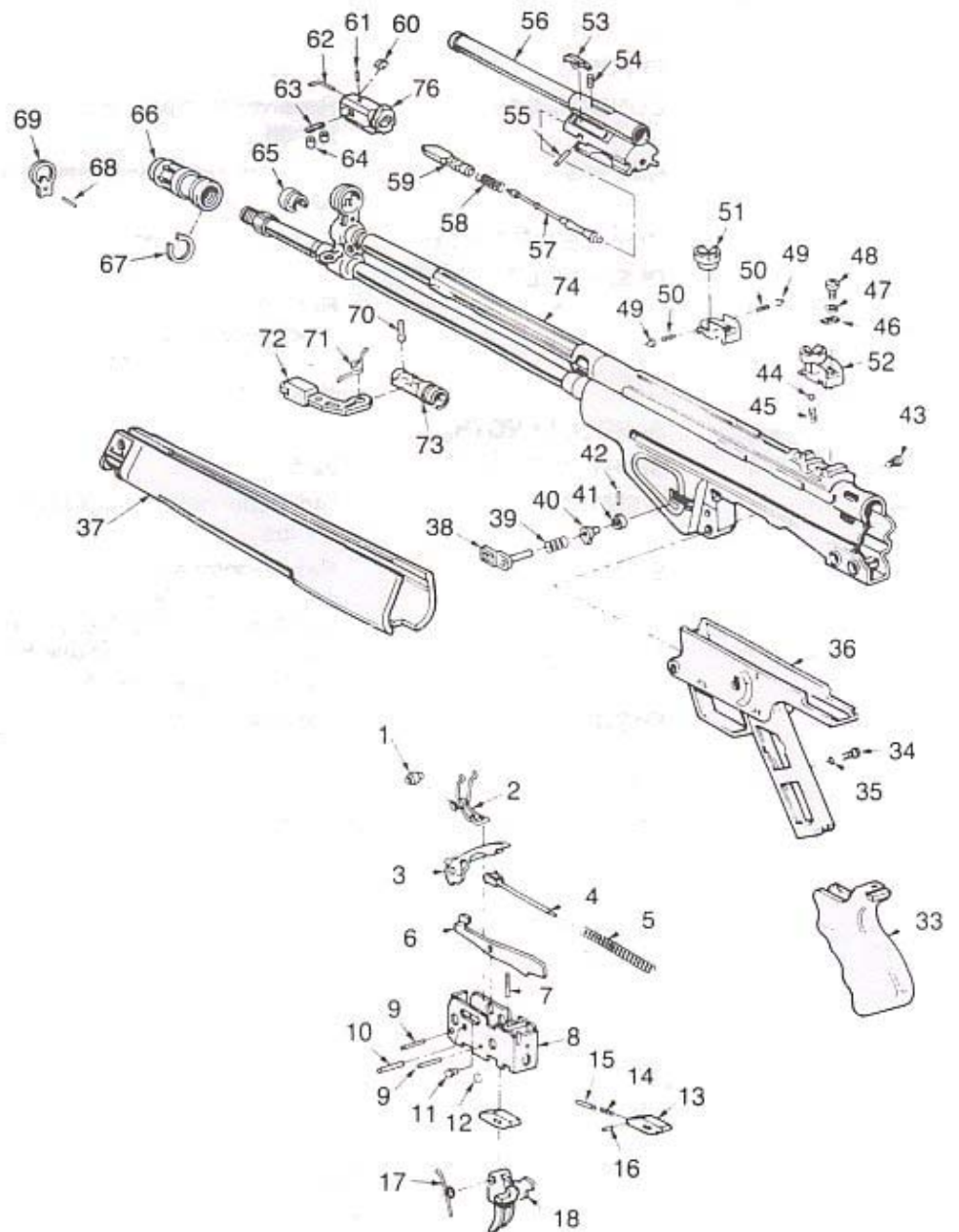

- | | |
|--|------------------------------------|
| 41. Push Button for Magazine Catch | 55. Cylindrical Pin (4mmx6x8) |
| 42. Clamping Sleeve 2x5x10 DIN 1481 | 56. Bolt Head Carrier |
| 43. Adjusting Screw | 57. Firing Pin |
| 44. Ball 3mm III-6 DIN 5401 | 58. Firing Pin Piece |
| 45. Compression Spring for Ball | 59. Locking Piece |
| 46. Washer for Rear Sight | 60. Extractor |
| 47. Locking Washer | 61. Clamping Sleeve Bolt Head |
| 48. Clamping Screw | 62. Extractor Spring |
| 49. Catch Bolt for Sight | 63. Holder for Locking Lever |
| 50. Catch Bolt Spring | 64. Locking Roller |
| 51. Sight Cylinder | 65. Cap Complete |
| 52. Sight Support | 66. Flash Hider |
| 53. Bolt Head Locking Lever | 67. Retaining Ring for Flash Hider |
| 54. Compression Spring for Bolt Head Locking Lever | 68. Clamping Sleeve 4x12 DIN 1481 |
| | 69. Front Sight |
| | 70. Axle for Cocking Lever |
| | 71. Elbow Spring for Cocking Lever |
| | 72. Cocking Lever |
| | 73. Support for Cocking Lever |
| | 74. Receiver w/Barrel |
| | 75. Recoil Spring Guide Tube |
| | 76. Bolt Head Stripper |

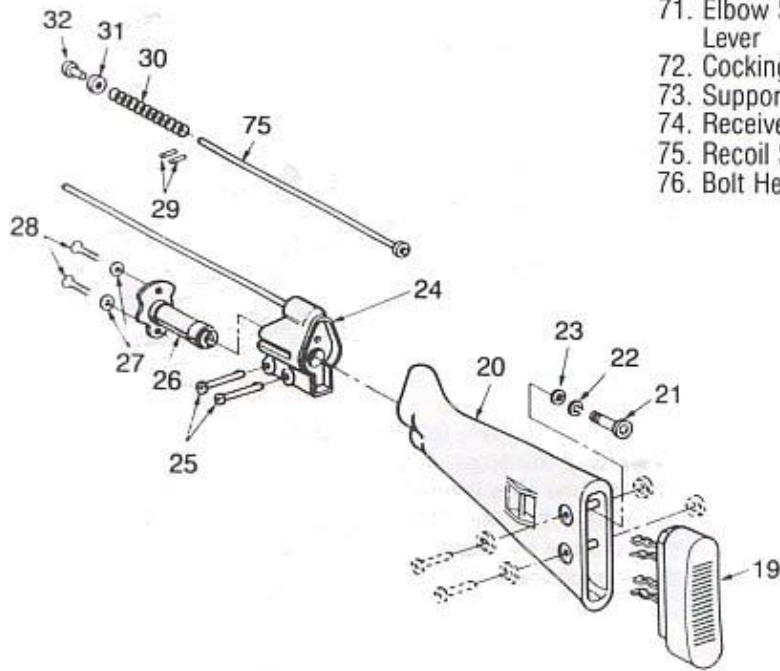

General Operation

The SAR-3 rifle operates on a delayed blowback principle, one of the safest and most reliable semiautomatic actions currently in use. When the cartridge is fired, the thrust of the cartridge case drives the bolt backwards, but the backwards movement is delayed by the mechanical arrangement of the bolt until the pressure has dropped to a safe limit. However, there is a slight rear movement of the fired cartridge case. To minimize this movement and to prevent ruptured cartridge cases, the front of the chamber is fluted (see illustration) to allow propellant gases to leak rearward along the cartridge case to aid in extraction of the fired case. Cartridge cases fired from a SAR-3 are readily identifiable by the well defined gas marks or slight grooves that extend about halfway down the case.

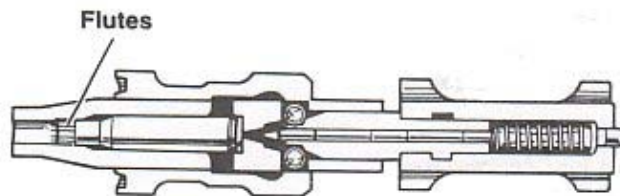

Disassembly Procedures (FIELD STRIPPING)

1. Before beginning disassembly, remove all slings, scopes and scope mounts.

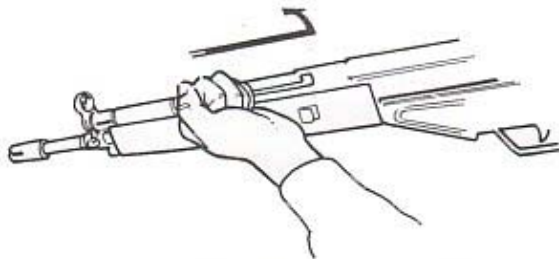

2. Remove the magazine and set the selector lever on "S" or "Safe"; then check the rifle to make sure it is unloaded. To inspect the SAR-3, unfold the cocking handle located on the left side of the rifle at the front of the handguard and pull the cocking handle towards you (rearward); then

rotate the handle upward into the retaining notch located near the back of the bolt. When inspection is completed, pull the cocking handle slightly

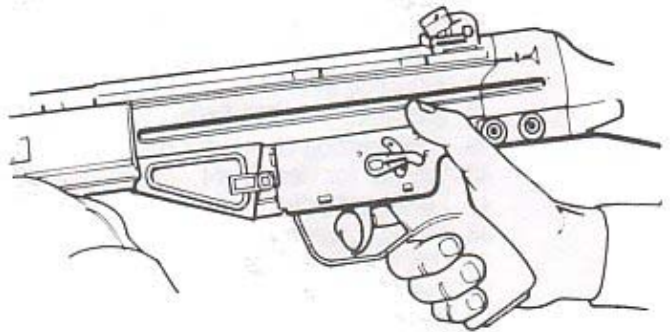

rearward and rotate it downward out of the retaining notch; then release the handle to allow it to return to its original position. Then *point the muzzle in a safe direction, rotate the selector lever to "F" or "Fire" and depress the trigger to allow the bolt to return to its closed or fired position. Rotate the selector back to "Safe" before proceeding.*

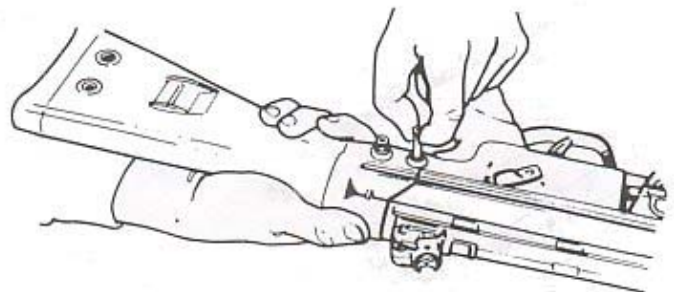

3. Remove the two takedown pins located just forward of the stock. No tools should be required to push the pins through from the right side to the left side of the rifle. When the pins are removed, they should be stored in the small storage holes in the rear of the stock.

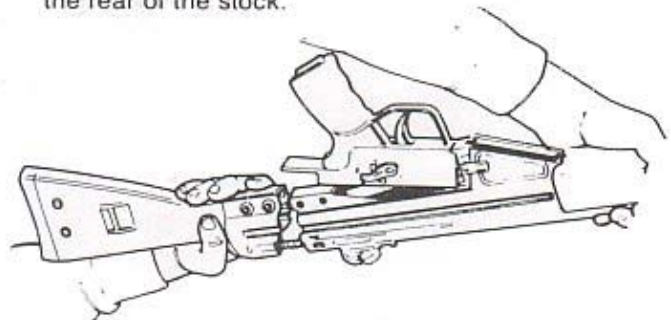

4. The buttstock and driving spring should now remove easily by pulling the butt stock straight back to the rear; the entire buttstock assembly will come out as a unit.



5. With the buttstock assembly removed, you can remove the entire trigger group by pulling downward on the pistol grip.

6. The bolt carrier should slide out of the rear of the receiver easily by merely tipping the muzzle upwards. *Be sure to place a hand at the rear of the receiver to catch the bolt carrier.* If the bolt carrier seems to be snug and will not slide out on its own accord, unfold the operating handle and pull it rearward. That action should push the bolt carrier into position for you to grasp it and remove it from the receiver. An excessively dirty rifle might also necessitate this action to remove the bolt carrier.

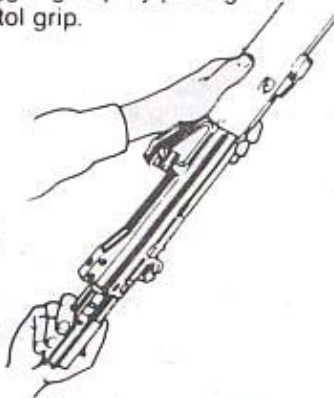

7. To disassemble the bolt assembly, first turn the bolt head one half turn counterclockwise and pull it forward out of the carrier. Then slowly rotate the locking piece counterclockwise until its lug clears the carrier. You can now remove the locking piece, the firing pin and the spring as a unit.

No further disassembly of the SAR-3 is either necessary or recommended beyond this point. Any repair or maintenance procedure that requires further disassembly of the rifle should be referred to a qualified gunsmith or armorer or to the Springfield Armory factory.

Assembly Procedure

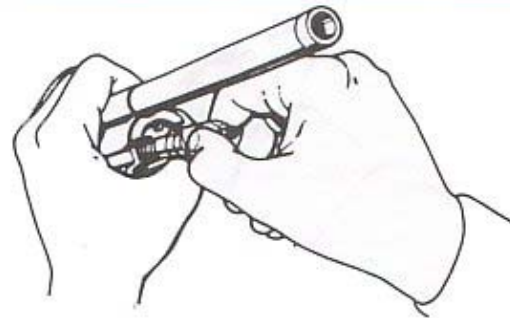
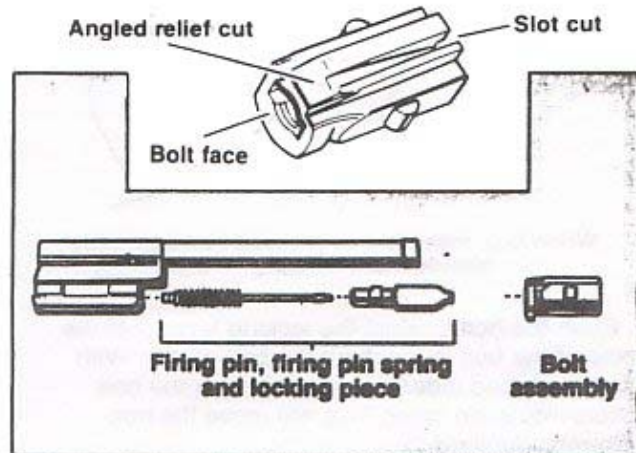

1. Insert the firing pin, firing pin spring, and locking piece into the bolt head carrier. Depress the locking piece into the carrier, and turn it one quarter turn clockwise.

Bolthead locking lever

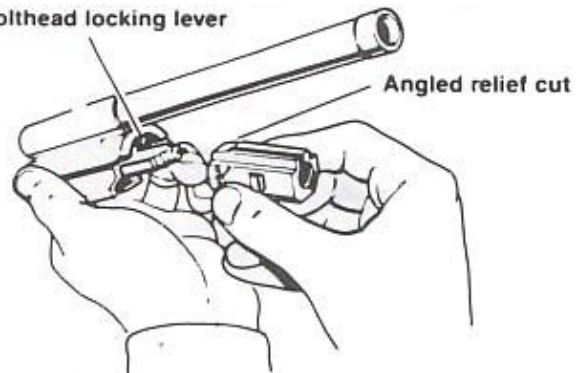

The angled relief cut on the bolt assembly will push the locking lever up.

Insert the bolt assembly onto the locking piece, making sure the slot cut on the bolt is at the top. Turn the bolt assembly slightly clockwise until the angled relief cut at the base of the bolt assembly is aligned with the bolt head locking lever.

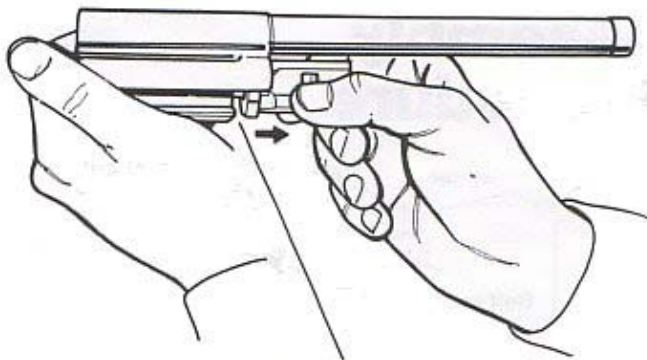

When bolt rollers are depressed bolt assembly should move forward $\frac{1}{4}$ " inch.

Push the bolt against the locking lever until the base of the bolt is touching the bolt carrier. With the thumb and index fingers, squeeze the bolt rollers into each other. This will move the bolt assembly forward.

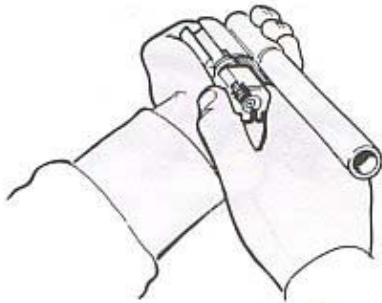

Grasping the carrier and bolt assembly firmly, turn the bolt clockwise until the slotted relief on the bolt is at the bottom position. Once again squeeze the bolt rollers to be sure they are in the fully depressed position. The bolt carrier and bolt assembly may now be inserted into the receiver.

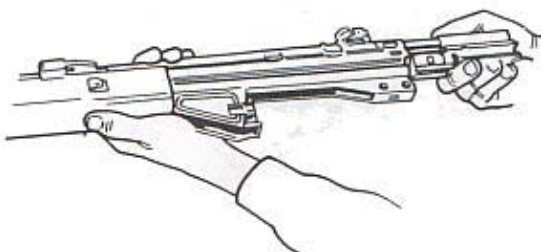

2. Check to be certain the operating handle is in the forward position. Then insert the complete bolt carrier assembly into the receiver as far as possible.

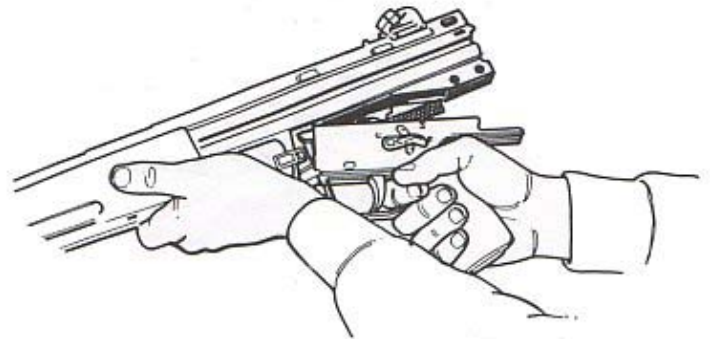

3. Reinstall the trigger group by first inserting the front of the trigger group, then rolling the rear end with the pistol grip into position.

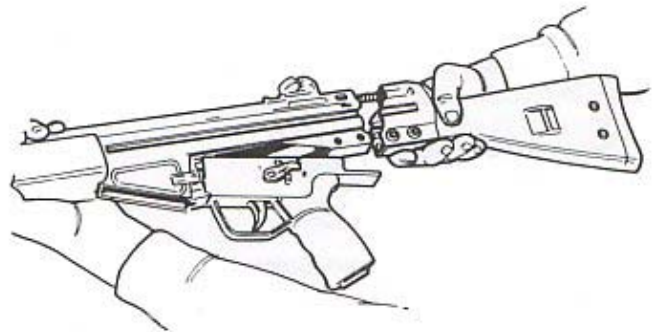

4. Slide the buttstock back into place over the rear of the receiver, with the driving spring properly positioned in its recess in the bolt carrier.

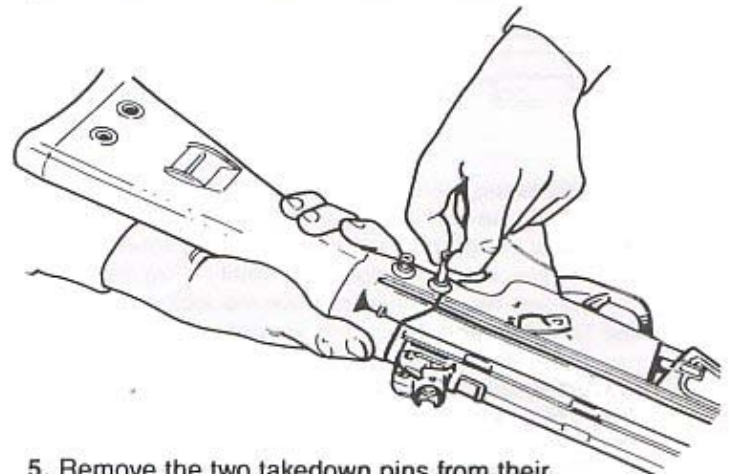

5. Remove the two takedown pins from their storage holes in the buttstock and insert them in their proper holes from left to right at the rear of the receiver. The SAR-3 is now fully assembled.

6. Reattach all slings, scopes and scope mounts.

Use Of The SAR-3

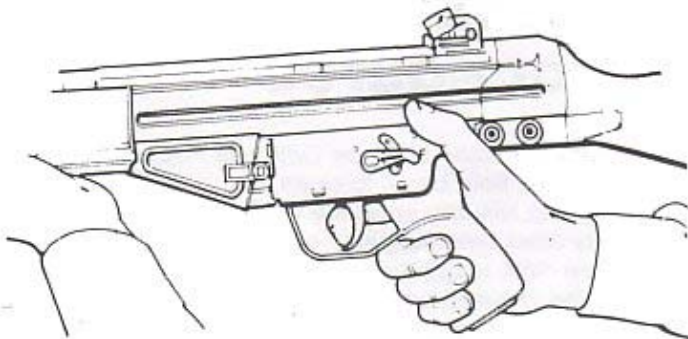

1. Before preparing to use the SAR-3, first make sure the selector lever on the left side of the receiver is in "S" or "Safe" position. While using the SAR-3, the selector lever can be easily manipulated with the thumb of your right hand if you are right-handed or the index finger of your left hand if you are left-handed.

2. To load the magazine, hold the magazine in either hand and use the other hand to place the first round on top of the magazine follower. Make sure the bullet end faces towards the front of the magazine. Then, apply pressure with the thumb to fully seat the round in the magazine. Place additional rounds in the magazine up to twenty rounds following the same procedure as the first round.

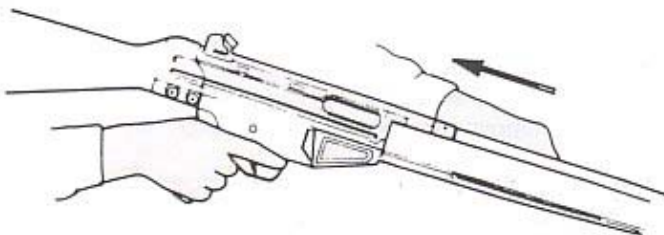
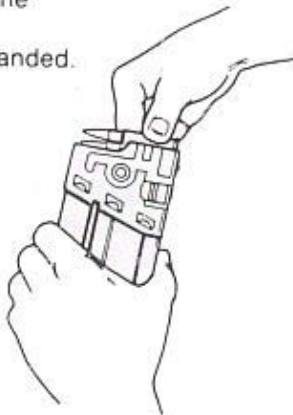

3. Check again to make sure the safety lever is on "S" or "Safe" position, then point the rifle in a safe direction. You may now cock the rifle by pulling the cocking lever rearward with your left hand and engaging it in the cocking lever notch.

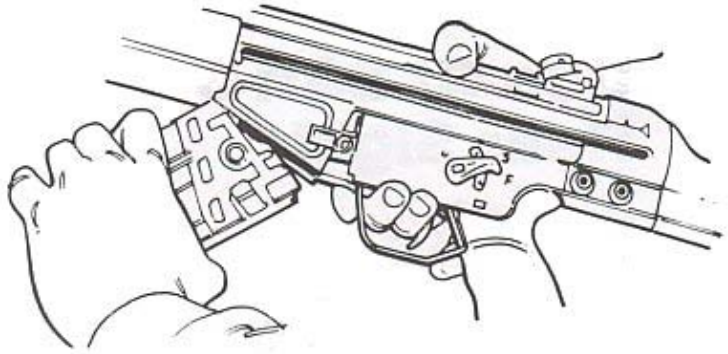

4. Insert the magazine into the magazine well. The magazine should be inserted, front end first with a slight bottom-forward cant, then rolling the rear of the magazine back into place. When the distinctive "click" of the magazine catch is heard, the magazine is engaged.

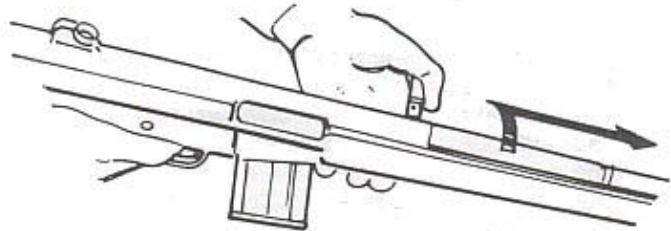

5. When the magazine is properly inserted in the magazine well, press the cocking lever with the thumb of your left hand to disengage it from the retaining notch. The bolt carrier will now travel into battery with its own spring tension. Do not touch the cocking handle as it travels forward into battery. The rifle is now cocked, and the first round is loaded in the chamber. *Keep the safety lever on "S" or "Safe" until you are ready to fire!*

6. Adjust the rear sight for windage and elevation as described on page 10.

7. Raise the rifle to the shooting position. Then choose your sight picture, move the selector lever to "F" or "Fire" position, and squeeze the trigger. Successive shots do not require recocking the rifle; they will cycle semiautomatically. *Caution: Never point or aim the rifle in a direction that is unsafe to shoot or at an object or surface that might cause the bullet to ricochet. Always wear proper eye and ear protection.*

Note: When the last round has been fired, the bolt will remain in battery (closed) instead of returning to an open bolt position.

Note: When you are finished shooting: Always engage the safety, remove the magazine by using the magazine release located on the right side of the receiver, and clear the rifle by pulling back on the cocking lever then releasing it quickly to allow it to return to its normal forward position.

Use Of SAR-3 Rear Sight

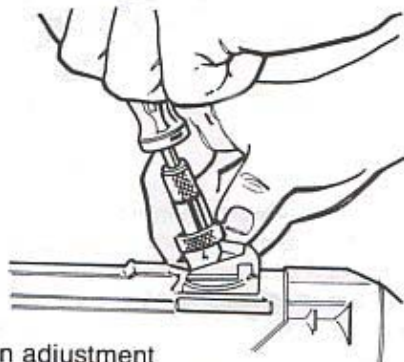

1. Elevation adjustment

Place the elevation adjustment tool in the rear sight drum in such a way that the wedges of the tool engage the splines of the drum. Then place the special screwdriver on top of the elevation adjustment tool and press downwards. Rotate the rear sight drum in the desired direction. (To lower the point of impact rotate the drum clockwise; to raise the point of impact rotate the drum counterclockwise.)

Note: By adjusting elevation for 100 meters, other ranges will simultaneously be adjusted. Every one-fourth of a revolution moves the point of impact 1.28 inches.

2. Windage adjustment

Using a phillips head screwdriver, loosen the rear clamping screw.

FIG. 1 If the bullet's point of impact is too far left, turn the adjusting knob counterclockwise with your fingers. **FIG. 2** If the point of impact is too far right, rotate the knob clockwise. Upon completing the desired adjustment, tighten the clamping screw.

Note: One revolution of the adjusting knob moves the point of impact 5.14 inches at 100 meters.

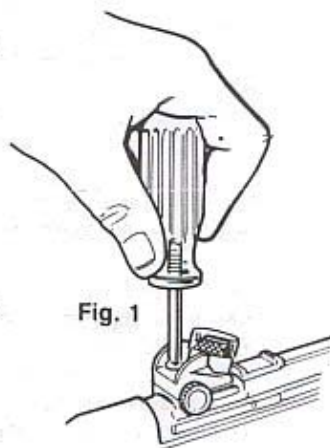

Fig. 1

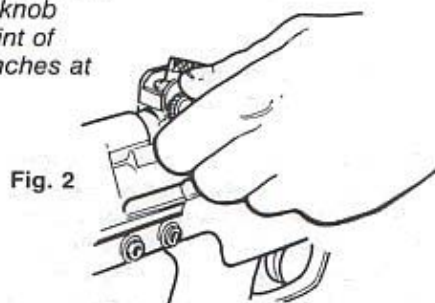

Fig. 2

Recommended Cleaning Procedures

1. Basic cleaning after use (with rifle field stripped)

■ Use the bore brush to clean all residue from the barrel, visually checking the barrel regularly. A lightly oiled cleaning patch or piece of clean flannel cloth might help remove all dirt or grime. If an oiled cleaning patch is used, complete the cleaning process with a clean, dry patch or a dry rag.

■ Follow the above procedure to clean the chamber, using the chamber brush rather than the bore brush.

■ Using a clean, lightly oiled rag, thoroughly clean the bolt assembly, the rear part of the barrel and inside the receiver. Dry them after they're cleaned.

■ Finish the whole cleaning process by lightly oiling all moving parts with a good quality lubricating gun oil, like Springfield Armory LSA Lubricant.

2. Complete barrel cleaning (the barrel requires special periodic attention)

■ We do not recommend the use of corrosive ammunition with the SAR-3 rifle. But, if you use corrosive ammunition, wash the barrel with soapy water to protect the bore from corrosive powder residue, using a solution of approximately 15% non-acid soap. Springfield Armory bore solvent can also be used. Be sure to keep soapy water out of the mechanism.

■ Dry thoroughly with a clean flannel rag.

■ Dry the outside of the barrel with another dry rag.

■ If the rifle is to be stored for any length of time, barrel grease should be applied to the bore after cleaning.

3. Cleaning before use

Before firing your SAR-3, it should be cleaned again to remove excess oil from all parts.

Note: The magazine should not be stripped or cleaned unless it has been subjected to excessive amounts of sand, grit or dampness.

Suggestion: We recommend the use of only high quality bore solvent, lubricants, and other cleaning aids, such as those listed in our product catalog and price sheet.

Trouble Shooting Guide

Problem	Possible Cause	Suggested Action
1. Bolt moves but does not load a cartridge.	a) Magazine loose or not properly inserted b) Magazine dirty or deformed	a) Reinsert magazine and check magazine catch b) Insert different magazine
2. Empty cartridge case not extracted or ejected.	a) Dirty chamber b) Broken extractor or ejector spring or defective ejector	a) Clean the chamber b) Repair required by Springfield factory or by qualified gunsmith
3. Cartridge will not ignite.	a) Bad cartridge b) Broken or shortened firing pin	a) Cock and chamber new cartridge b) Repair required by Springfield factory or by qualified gunsmith
4. Bolt will not close completely.	a) Dirty chamber b) Dirty barrel extension c) Deformed cartridge d) Defective recoil spring	a) Clean the chamber b) Clean the barrel extension c) Cock and chamber a new cartridge d) Repair required by Springfield factory or by qualified gunsmith
5. Rifle fires irregularly or misfires sporadically	a) Defective ammunition b) Magazine loose or improperly inserted c) Magazine dirty or deformed d) Dirty chamber	a) Use different ammunition b) Reinsert magazine and check magazine catch c) Insert different magazine d) Clean the chamber

IMPORTANT!

1. Safety first...always!

Before disassembly or handling, *always* check to be sure the chamber is empty. And *always* point firearms in a safe direction.

2. Maintenance

Proper performance and safe operation depends on proper maintenance. Always keep your SAR-3 rifle in proper working order. All repairs or maintenance beyond the basic field stripping and cleaning described in this booklet should be referred to a qualified, professional gunsmith or to the Springfield Armory factory.

WARNING!

Rifles are classified as FIREARMS and DANGEROUS WEAPONS. Injury or death to you or others might result from unsafe or improper use. Springfield Armory, Inc. will not be responsible for the results of careless handling, unauthorized repairs and adjustments, corrosion, neglect, or unreasonable use.

Springfield Armory, Inc. assumes no responsibility for damage and/or injured caused in whole or in part by handloaded, reloaded or defective ammunition. Under no circumstances shall Springfield Armory, Inc. be responsible for incidental or consequential damages with respect to economic loss or injury to property, whether as a result or breach of expressed or implied warranty, use of handloaded or remanufactured ammunition, negligence, unsafe handling, or otherwise.

Do not dry fire! Dry firing any firearm could result in serious damage to the firearm or serious injury to the shooter or others.



The Oldest Name In American Firearms

SPRINGFIELD ARMORY®

420 West Main Street, Geneseo, Illinois 61254
(309) 944-5631



ALWAYS WEAR EYE AND EAR PROTECTION
WHEN SHOOTING ANY FIREARM!