

Owner's Manual

Owner's Manual for:
Remington Model SPR 453
Auto Loading Shotgun

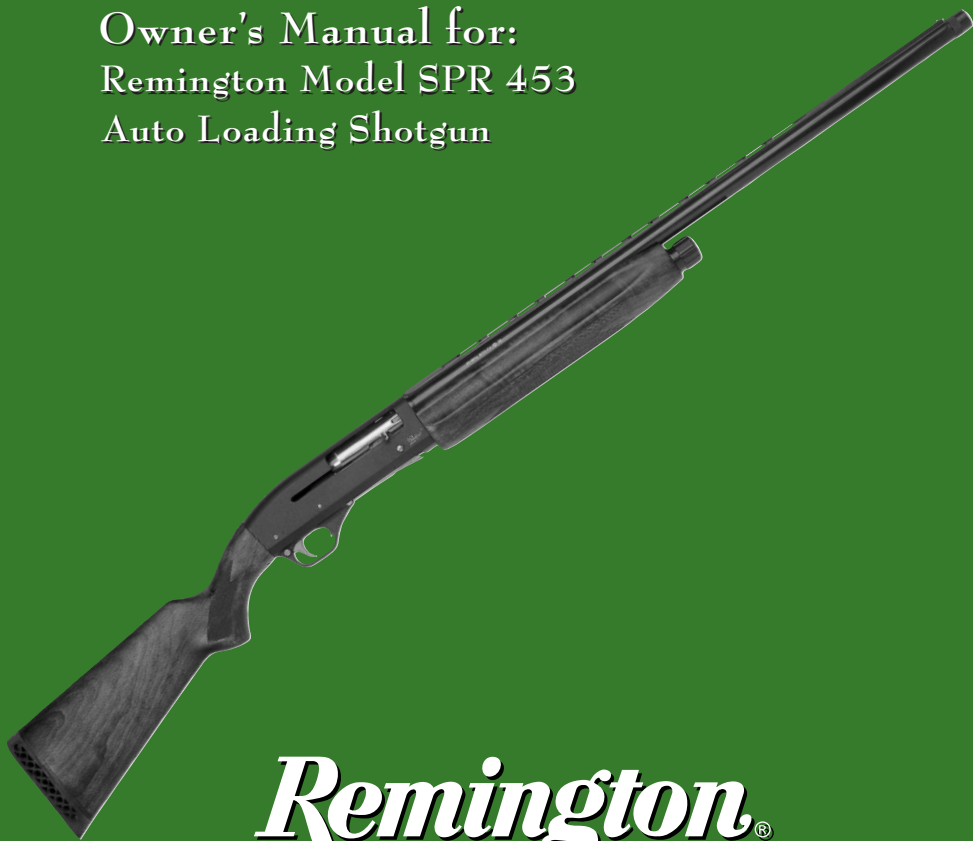

Remington®

IMPORTANT!

READ ALL WARNINGS AND
INSTRUCTIONS IN THIS
MANUAL BEFORE USING THIS SHOTGUN



PAGE 2THE TEN COMMANDMENTS OF FIREARM SAFETY

PAGE 7IMPORTANT PARTS OF THE FIREARM

PAGE 10.....ASSEMBLY INSTRUCTIONS

PAGE 13.....LOADING AND UNLOADING

PAGE 15FIRING

PAGE 18DISASSEMBLY INSTRUCTIONS

Safety is Critical to Performance.

A superbly crafted gun is only as good as the hands that hold it. You can never be too careful. Shooting accidents are often caused by careless oversights such as failing to control the direction of the muzzle, failing to fully engage the safety, leaving ammunition in the chamber or using improper loads. These oversights can result in the destruction of life, limb or property. There's no calling back a bullet once it's been fired, so it's critical that you know the principles of safe gun handling and storage before you ever take your new Remington firearm out of the box.

The proper use and performance of your firearm depends on correct assembly and maintenance, so it's critical that you familiarize yourself with the information in this instruction book. Even if you're a veteran shooter with a collection of Remington firearms, take the time to read this literature. Not all firearms are the same. That means the first step in safe handling is to learn the features and requirements of your new Remington.

THE TEN COMMANDMENTS OF FIREARM SAFETY

With the privilege of owning a firearm comes the responsibility to use it safely. You must understand and follow the Ten Commandments of Firearms Safety at all times. These time-honored safety rules apply to your ownership and handling of any firearm. They must govern your actions whenever and wherever you are involved with firearms . . . in the field, on the range, or in your home. Commit these Ten Commandments to your memory.

1st COMMANDMENT

Always Keep the Muzzle Pointed in a Safe Direction.

This is the most important gun safety rule. A safe direction is one in which an accidental discharge will not cause injury to yourself or others. Never allow your gun to point at anything you don't intend to shoot. Be especially careful when you're loading or unloading. Treat every gun as if it were loaded. And make it a habit to know where the muzzle is pointed at all times, even when your firearm is unloaded. No one will be injured by an accidental discharge if you keep your firearm pointed in a safe direction. It's as simple as that.

2nd COMMANDMENT

Firearms Should be Unloaded When Not in Use and Secured from Unauthorized Use.

Load your firearm only when you are in the field or on the range and ready to shoot. Unload your firearm as soon as you are finished shooting. Never bring a loaded firearm into your camp, home or vehicle. Unloading means unloading both the chamber and the magazine. Before handling a firearm or passing it on to someone else, visually check the chamber, receiver, and magazine to make sure there is no ammunition anywhere in the firearm. Never assume a firearm is unloaded, and never take someone's word for it - look for yourself. When you are finished shooting and have completely unloaded the firearm, leave its action open.

Whenever you are carrying a loaded firearm in the field, you must unload it before crossing a fence, climbing into a tree stand or blind or in any other situation where you may not be able to fully control the firearm. Never pull or push a loaded firearm toward yourself or another person.

Store your firearms unloaded in a secure place where unauthorized persons cannot gain access to them. Store firearms and ammunition separately. If you use an external security device such as a cable lock or trigger lock, you must still keep the firearm unloaded when locked. Whether you utilize a locked gun safe or external locking device, it is your responsibility to make sure that children and other unauthorized persons cannot gain access to your firearm and ammunition.

3rd COMMANDMENT

Never Rely on Your Firearm's Safety Mechanism to Justify Careless Handling.

If your firearm is equipped with a manual safety mechanism, do not rely on the safety as an excuse for improper or careless handling of the firearm. The safety mechanism is merely a supplement to your proper handling of the firearm. The safety mechanism may be broken or altered. Even if you think you have previously engaged the safety in the "safe" position, it may have been inadvertently disengaged without your knowledge while being carried. Never assume that the safety mechanism is engaged in the "safe" position. Your assumption may be wrong or mistaken. Treat your firearms safety mechanism like you would treat any other mechanical device - as something that could break or fail.

Not all safety mechanisms operate in the same manner. Before using any firearm, know and understand precisely how the safety mechanism on that particular firearm operates. Never pull the trigger when the safety mechanism is in the "safe" position, and keep your fingers away from the trigger while loading, unloading, and engaging or disengaging the safety mechanism.

4th COMMANDMENT

Know Your Target and What's Beyond It.

Never fire a shot unless you know exactly where the shot is going and what it will strike. Bullets and shot can travel great distances with deadly velocity. When hunting game, never fire at a sound, a movement or a patch of color - an impulsive shot can have tragic consequences. A fellow hunter in camouflage may be mistaken for game by an impulsive shooter.

In addition to being sure of your target, you must know what lies beyond the target. In other words, make sure of your backstop. Also, beware of ricochets - never shoot at water or a hard surface.

5th COMMANDMENT

Use Proper Ammunition.

Every firearm is designed to use only a specified caliber, gauge or length of ammunition. Use of the wrong ammunition can cause serious personal injury or death. It is your responsibility to make sure the ammunition exactly matches the specifications for your firearm.

Use of improperly reloaded ammunition can also be dangerous. Firearms are designed, manufactured, and proof-tested to specified industry standards. Hand-loaded or reloaded ammunition that deviates, either intentionally or accidentally, from specified loadings can be extremely hazardous. It is strongly recommended, therefore, that you use only factory ammunition from a reputable ammunition manufacturer. If you do reload, you have assumed the risks and responsibilities of an ammunition manufacturer.

6th COMMANDMENT

If Your Firearm Fails to Fire When You Pull the Trigger, Handle With Care.

If a chambered round of ammunition does not fire when you pull the trigger, stop and keep the muzzle pointed in a safe direction. Treat your firearm as if it could still discharge. Keep your face away from the breech. Slowly and carefully open the action, return the safety mechanism to the "safe" position, and unload the cartridge from the chamber. Dispose of the cartridge safely. If your firearm repeatedly fails to fire when you pull the trigger, take your firearm and ammunition to a competent gunsmith or return the firearm to the manufacturer for inspection.

7th COMMANDMENT

Always Wear Eye and Ear Protection.

Wear protective shooting glasses and hearing protection when shooting. Be sure to wear eye protection when disassembling or cleaning a firearm to protect your eyes from springs and other tensioned parts. Continued exposure to shooting noise can permanently damage your hearing.

8th COMMANDMENT

Be Sure the Barrel is Clear of Obstructions Before Shooting.

With your firearm completely unloaded, open the action and make sure there are no obstructions or debris in the barrel. Even a small obstruction such as snow or mud in the barrel can cause the barrel or receiver to burst when the next round is fired. Use a cleaning rod to remove obstructions and residues from the barrel. If the firing noise or recoil seems weak, stop and completely unload your firearm to check for obstructions before firing another shot. NEVER try to shoot out an obstruction by loading and firing another round of ammunition.

9th COMMANDMENT

Never Alter or Modify Your Firearm and Have it Cleaned and Serviced Regularly.

Your firearm has been carefully designed and manufactured to operate according to certain factory specifications. NEVER alter or modify your firearm, especially its trigger or safety mechanism, in any way. Such alterations or modifications can adversely affect the safe operation of your firearm, endangering you and those around you.

As with any mechanical device, the parts of a firearm are subject to wear or breakage. To assure optimum safety and performance, your firearm must be maintained and serviced on a regular basis. Only a competent gunsmith or a Remington Authorized Service Center should service or repair your firearm.

Proper cleaning and lubrication are also important to maintain the safe and proper functioning of your firearm. Follow the cleaning and lubrication instructions set forth in the owner's manual for your firearm. NEVER attempt to clean or lubricate a loaded firearm.

10th COMMANDMENT

Learn How Your Firearm Operates.

Not all firearms are alike. Before you use any firearm for the first time, you must become totally familiar with how that firearm operates. When you receive a new firearm, read and understand the owner's manual before assembling the firearm for the first time. If you acquire a used firearm, request an owner's manual and have the rifle inspected by a competent gunsmith to determine whether it is in good working order. If you do not have an owner's manual, contact the manufacturer to obtain one. If you are selling or trading your firearm to someone else, be sure to transfer the owner's manual to the new owner.

LEAD EXPOSURE WARNING

Discharging firearms in poorly ventilated areas, cleaning firearms or handling ammunition may result in exposure to lead, a substance known to cause birth defects, reproductive harm, cancer and other serious physical injury. Have adequate ventilation at all times. Wash hands thoroughly after exposure.

SHOOT SOBER!

Guns and alcohol or drugs don't mix. Never consume anything that would even mildly impair your judgement or physical coordination while handling a firearm.

WARNING

Failure to follow any of these safety rules may cause personal injury or death to the shooter or bystander and damage to property. Do not use a firearm until you fully understand and practice the Ten Commandments of Firearm Safety. If you have any questions about the safe use of a Remington firearm, write to us at Remington Arms Company, Inc., Consumer Service, P.O. Box 700, Madison, NC 27025-0700, or call us at 1-800-243-9700.

Use the Security Lock Provided with your Shotgun

This shotgun comes with a security lock to assist in protecting against unauthorized use. (See **Picture 1**). The shotgun must be completely unloaded when the security lock is in place. **WARNING:** Using the security lock cannot substitute for securing your firearm and ammunition in separate, locked locations.

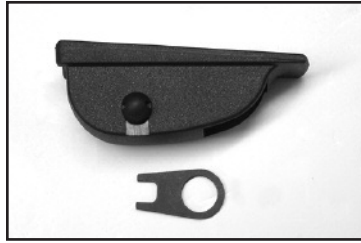

Picture 1

The security lock operates as follows:

1. To open the Trigger Lock put the Key into the notches of the Trigger Lock Nut and unscrew it counter-clockwise. (See **Picture 2**). Remove the Trigger Lock Screw.

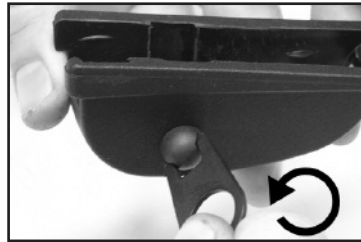

Picture 2

2. To install the Trigger Lock, put the Trigger Lock over the trigger guard with the smaller end of the Trigger Lock shroud pointing toward the muzzle. Then place the Trigger Lock Screw through the cross-slotted hole on the side of the Trigger Lock Shroud. (See **Pictures 3 and 4**).

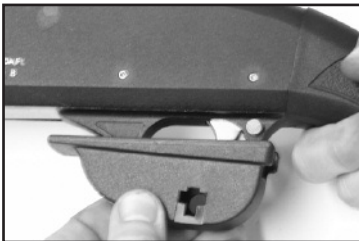

Picture 3

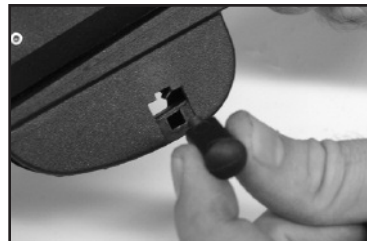

Picture 4

Use the Security Lock Provided with your Shotgun (cont'd)

3. To secure the Trigger Lock on the trigger guard insert the Trigger Lock Screw into cross hole of the Trigger Lock choose the best position for preventing the Trigger Lock from moving (See **Picture 5**).

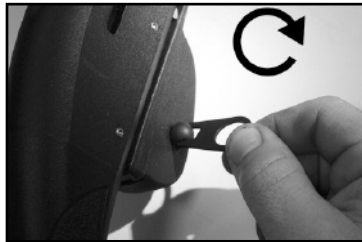

Picture 5

4. To remove the Trigger Lock, unscrew the Trigger Lock Nut with the key and detach the Trigger Lock Screw. (See **Picture 6**).



Picture 6

WARNING

Always store the key to the security lock: (1) in a separate location away from the auto loading shotgun; (2) in a secure location unknown and not accessible to others, especially children. Whether you secure your firearms by using the supplied security lock, a gun lock or safe or some other mechanism, it is YOUR RESPONSIBILITY to store your firearms in such a manner that children and other unauthorized persons cannot gain access to them.

Important Parts of the Firearm

Congratulations on your choice of a Remington® Model SPR 453 Auto Loading shotgun. With proper care and if used in accordance with the Ten Commandments of Firearm's Safety and this owner's manual, your shotgun should give you many years of dependable use and enjoyment. The following picture depicts the main parts of your shotgun and will aid in understanding the instructions in this Owner's Manual.



This picture shows the main parts of a Remington Model SPR453 Auto Loading shotgun. The picture will aid in understanding the instructions in this book.

External Control Parts

Trigger Block Safety: The trigger block safety of the Model SPR 453 shotgun provides protection against accidental and unintentional discharge under normal usage when properly engaged and in good working order. The safety mechanism is not a substitute for following the rules of safe gun handling. Do not disengage the safety unless you are ready to fire. **MAKE SURE YOU UNDERSTAND HOW THE SAFETY WORKS BEFORE YOU LOAD OR USE THE SHOTGUN.**

The safety mechanism is a cross-bolt-button-style safety located on the trigger housing behind the trigger. To place the safety in the "on" or "safe" position, push the button all the way to the right. (See Picture 7). When in the "on" or "safe" position, the safety blocks the rearward motion of the trigger. To place the safety in the "off" or "fire" position, push the button all the way to the left. When in the "off" or "fire" position, a red ring is exposed on the left side of the safety button. See Picture 8. You have now disengaged the safety and the shotgun is in the ready-to-fire position.



Picture 7



Picture 8

WARNING

Do not touch the trigger while moving the safety button. When operating the safety button, make sure you push it to the full extent of its travel in the desired direction, either fully "on" or fully "off." Half-safe or partially safe is UNSAFE.

External Control Parts (cont'd)

Carrier Latch/Bolt Release Button: The carrier latch/bolt release button is located on the right side of the shotgun and protrudes out of the forward right hand side of the receiver. (See **Picture 9**). Pushing in on the button will release the carrier latch as well as release the bolt if it is in the rearward position.

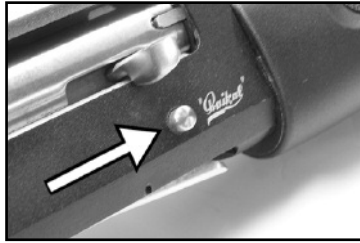

Picture 9

Carrier Latch: The carrier latch is located under the receiver in front of the trigger guard. (See **Picture 10**). Depressing the carrier latch will release the lock on the latch so that it can be moved for loading the shotgun.



Picture 10

Trigger: The trigger is located in the trigger guard. (See **Picture 11**). If you pull the trigger with the safety in the "OFF" or "FIRE" position, the shotgun will fire.



Picture 11

WARNING

Never pull the trigger until you are actually ready to fire. Keep your fingers off the trigger and outside of the trigger guard until you are ready to pull the trigger and fire the shotgun. When opening and closing the action and when engaging or disengaging the safety mechanism, make sure your fingers are outside the trigger guard and away from the trigger.

External Control Parts (cont'd)

Bolt Cocking Handle: The bolt cocking handle is located on the right side of the shotgun and protrudes from the bolt and is used for pulling the bolt rearward. (See **Picture 12**). Please note that if the shotgun has been cocked and the bolt has been released to the forward position, the bolt will not lock back in the rearward position unless the carrier stop button has been moved rearward.

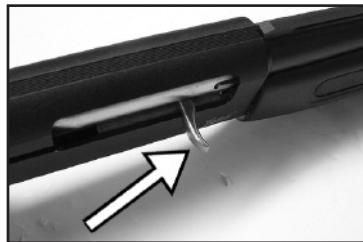

Picture 12

Carrier Stop Button: The carrier stop button is located on the right hand of the receiver at the forward end of the trigger housing. (See **Picture 13**). The carrier stop button is a flat button that moves forward and rearward and resets the bolt catch and locks the carrier latch in the down position. If the shotgun has been cocked, the bolt will not lock back in the rearward position unless this button has been pushed rearward.

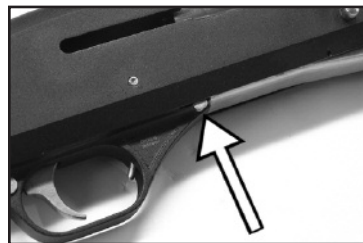

Picture 13

The Forend Cap: The forend cap is located on the end of the magazine tube at the front of the forend and under the barrel. (See **Picture 14**). The forend cap screws onto the magazine tube using a right-hand thread.

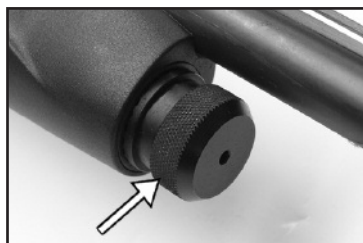

Picture 14

WARNING

The forend cap is under spring pressure. Use caution when screwing and unscrewing the forend cap from the end of the magazine tube.

The Serial Number: The shotgun's serial number is located on the left bottom side of the receiver.

The Cocking Indicator: The cocking indicator is located in the front inside of the trigger guard. (See **Picture 15**). When cocked the indicator is visible. When fired or uncocked, the indicator is not visible. (See **Picture 16**).

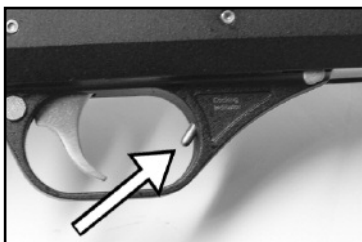

Picture 15

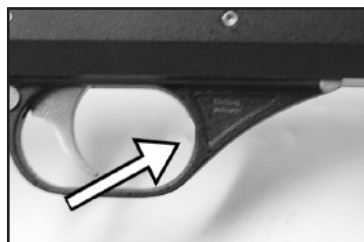

Picture 16

WARNING

The cocking indicator is merely an aid to help you confirm when hunting or shooting that your shotgun is cocked and ready-to-fire. NEVER rely on the status of the cocking indicator to justify careless handling of your shotgun. The ##### indicator may be broken or obscured. Always handle your shotgun as if it were loaded, cocked and ready-to-fire.

Instructions For Assembly Of Shotgun

WARNING

Before you begin to assemble the shotgun, you **MUST** (1) look down the barrel from the breech end toward the muzzle end to make sure there is no ammunition in the chamber or obstruction in the barrel (See **Picture 17**), and (2) make sure the safety is in the "ON" or "safe" position.



Picture 17

Your shotgun was shipped with the barrel detached from the receiver assembly. To assemble the shotgun, follow these instructions:

1. When you open the box of your next Model SPR 453 shotgun, the barrel is separated from the stock and receiver of the shotgun. To attach the barrel, first remove the stock and receiver from the plastic bag. Then unscrew the forend cap. (See **Pictures 18 and 19**).



Picture 18



Picture 19

WARNING

The magazine cap is under spring pressure. Note: After assembly of the shotgun the spring in the magazine tube may become twisted. This will cause a decrease in magazine tube capacity. If you load and unload the magazine tube the spring will untwist and the capacity should be as defined in the manual.

2. If the plastic spring cap is not installed in the magazine tube, use a small pin in the hole in the end of the magazine tube to hold the spring during removal of the cap. Unscrew the cap until you see the hole in the tube. Then insert the pin through the hole and hold the spring. (See **Picture 20**).

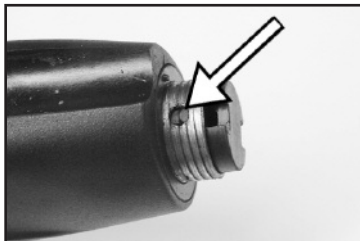

Picture 20

Instructions For Assembly Of Shotgun (cont'd)

3. Remove the forend from the magazine tube. (See **Picture 21**).



Picture 21

4. Remove the barrel from the box and remove the plastic bag from the barrel. Insert the barrel extension into the receiver (between the bolt and the receiver) while making sure the barrel lug is aligned with the magazine tube. Continue sliding the barrel extension into the receiver and allow the barrel lug to slide over the magazine tube. With the barrel extension partially inserted into the receiver between the bolt and the receiver, pull the bolt cocking handle to the rear so that the bolt is locked back. Now completely insert the barrel extension into the receiver. (See **Picture 22**).
5. Slide the forend over the magazine tube. Do NOT force the forend. Make sure that the forend is completely seated around the magazine tube, barrel, and the receiver. The forend MUST be flush with the receiver. (See **Picture 23**).



Picture 22



Picture 23

6. Screw on the forend cap so that the forend is held firmly in place and flush against the receiver. (See **Picture 24**).



Picture 24

Instructions For Assembly Of Shotgun (cont'd)

7. With the forend and the barrel in place and the forend cap securely in place, depress the carrier latch button and the bolt will slide into the barrel extension (Note: If you see any portion of the barrel extension protruding from the receiver after you released the bolt or if there is a gap between the forend and the receiver you have not properly assembled the shotgun). If the bolt does not slide forward or you have gaps or the barrel extension protrudes from the receiver, reverse the assembly procedures and start over again making sure that the barrel is fully inserted into the receiver and that the forend is fully in place. If you still cannot assemble the shotgun correctly, take the shotgun to the dealer where you bought the shotgun or to a qualified gunsmith for assistance.
8. Once the shotgun is assembled (or if you cannot fully assemble the shotgun and plan to carry it somewhere for assistance) engage the trigger block safety and keep it engaged in the "ON" or "safe" position until you are ready to fire the shotgun. Keep the safety "on" no matter if the gun is loaded or unloaded.

Note!

Locking Block Placement: During assembly or reassembly make sure the locking lug is in placed as pictured. See Picture 25. Make sure that the firing pin spring and the firing pin washer are held rearward by the locking lug. (See **Picture 26**)

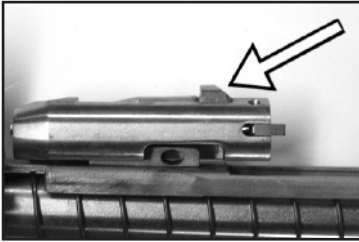

Picture 25

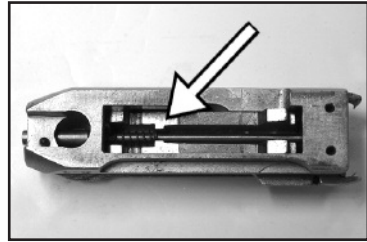

Picture 26



WARNING:

Never load or fire the shotgun unless the barrel is properly attached to the receiver, and the forend is properly locked into the receiver.



WARNING

Make sure the shotgun is pointed in a safe direction and the trigger block safety is engaged at all times while loading and unloading. NEVER allow fingers or other objects to contact the trigger while loading or unloading.



WARNING

Do not disengage the trigger block safety until you are ready to fire and have the shotgun pointed safely downrange



WARNING: Do not load the shotgun until you are ready to fire.

Loading and Unloading Your Shotgun

TO LOAD:

1. Make sure the ammunition that you are using is the correct size and gauge. The barrel is marked with the gauge and chamber size. A barrel marked 3 1/2" (89mm) will use 2 3/4" (70mm), 3" (76mm) or 3 1/2" (89mm) shotshells of the correct gauge as marked on the barrel.
2. Visually inspect the chamber and barrel for obstructions by pulling back the bolt until it locks back. Note that if the bolt will not lock back then push the Carrier Stop Button (see **Picture 13**) rearward and retry locking the bolt rearward. The chamber and barrel should be free of oil or grease or obstructions. (See **Picture 27**).

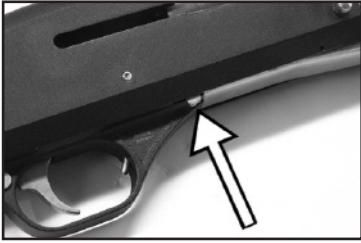

Picture 13



Picture 27

3. After inspection, release the bolt by depressing the carrier latch button (See **Picture 9**).

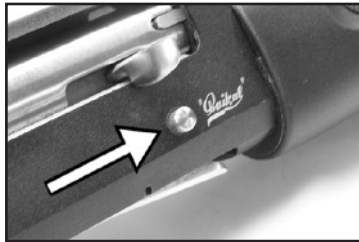

Picture 9

4. Turn the shotgun upside down so that the barrel is pointing toward the ground and you are looking at the carrier latch. Now depress the carrier latch and insert up to five (5) – 2 3/4" cartridges or five (5) – 3" cartridges or (4) – 3 1/2" cartridges into the magazine tube. Note that if the plastic spring cap is in the magazine tube, then the magazine capacity is decreased by one round. (See **Picture 28**).



Picture 28

Loading and Unloading Your Shotgun (cont'd)

TO UNLOAD:

1. Make sure the trigger block safety is engaged and your fingers are away from the trigger. Keep the muzzle pointed in a safe direction. Draw back the bolt until a cartridge is ejected or the bolt has traveled to the rear fully. (See **Picture 29**). If there was no cartridge in the chamber, nothing will be ejected. Slide the bolt back forward until it is fully closed. Repeat the drawing back of the bolt while depressing the carrier stop button until no more rounds are ejected from the shotgun.



Picture 29

2. When you have ejected the last round from the shotgun, pull the bolt fully to the rear. The bolt should lock in the rearward position. With the bolt locked back, visually inspect the chamber to insure that it is empty. You should also look down into the receiver through the ejection port and verify that the magazine tube is empty. (See **Picture 30**).



Picture 30

If for some reason a cartridge in the magazine tube will not rise up into the chamber to be ejected, after repeated attempts to manually cycle the shotgun, perform the following steps:

- A) Manually close the bolt by depressing the bolt release button.
- B) Turn over the shotgun so that the trigger guard is facing you (upward). Depress the carrier latch button and then depress the carrier latch. (See **Picture 31**).

- C) With the same finger that you are depressing the carrier latch, depress the Shell Latch. The Shell Latch is located on your left hand side with the shotgun in the upside down position. It is the piece of metal that should be holding the round in the magazine tube. The cartridge should slide up and out of the magazine with your guidance. Note: the cartridge is under spring tension. Repeat this process until the magazine tube is empty. Turn the shotgun over and lock the bolt back and verify that the gun is empty. If you had to follow the procedure for a cartridge that was not being released from the magazine tube, make sure the shotgun is empty and let a qualified gunsmith inspect the shotgun before you load or use the shotgun again

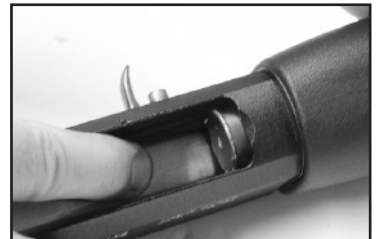

Picture 31

Firing Your Shotgun



WARNING: Never load or fire the shotgun unless the barrel is properly attached to the receiver, and the forend is properly locked into the receiver.



WARNING

Do not disengage the trigger block safety until the shotgun is pointed in a safe direction and you are ready to fire.



WARNING

If a cartridge does not fire and the trigger has been pulled and the trigger block safety is disengaged... Stop! and do the following: a) Make sure the gun is pointed in a safe direction b) Engage the trigger block safety c) Wait 60 seconds d) Follow the instructions above for unloading the shotgun.



WARNING

If during firing the sound of any cartridge is noticeably softer or louder than the previous cartridge fired... Stop! Do not load another cartridge or fire another cartridge and do the following: a) Make sure the gun is pointed in a safe direction b) Engage the trigger block safety c) Follow the instructions above for unloading the shotgun and d) With the shotgun unloaded, visually inspect the barrel for blockage or damage. Then inspect the receiver of the shotgun for damage before continuing.

READ, UNDERSTAND AND FOLLOW ALL WARNINGS AND INSTRUCTIONS IN THIS MANUAL BEFORE FIRING THE SHOTGUN.

TO FIRE THE SHOTGUN:

- 1) Make sure the shotgun is pointed in a safe direction with the trigger block safety engaged. (See **Picture 32**).
2. Make sure you are wearing eye and ear protection.
3. Keeping your fingers away from the trigger, push the trigger block safety to the “off” or “fire” position with the red ring showing. (See **Picture 33**).



Picture 32



Picture 33

4. With the butt stock held firmly against your shoulder and the barrel pointed towards your intended target, place your trigger finger on the trigger. The shotgun will fire when you pull or squeeze the trigger with the requisite force. See Picture 34. Auto loading shotguns automatically eject the fired cartridge from the chamber and feed the next live round from the magazine tube into the chamber each time the shotgun fires. No mechanical force is required for the shotgun to complete the ejection and chambering operations.

Firing Your Shotgun (cont'd)

(See **Picture 34**). Auto loading shotguns automatically eject the fired cartridge from the chamber and feed the next live round from the magazine tube into the chamber each time the shotgun fires. No mechanical force is required for the shotgun to complete the ejection and chambering operations.



Picture 34

WARNING

You must be aware that the firearm will be ready to fire another round immediately after the previous round has been ejected and the new round has been chambered. If you finish shooting before the last round in the shotgun is fired, you must immediately put the safety in the "ON" or "SAFE" position and control the direction of the muzzle. Remember that a live round is in the chamber.

WARNING

During firing, the bolt cocking handle travels rearward with considerable force and velocity. Do not allow any object to enter or obstruct its path.

5. Once you fire all the rounds from the shotgun, the bolt should lock open upon firing of the last cartridge. Never rely on the locked back bolt as a signal that the gun is empty. ALWAYS visually check the chamber to insure that the gun is empty. It is also possible that the bolt will not lock back after the firing of the last cartridge. If this occurs, open the bolt manually and lock it to the rear. Note: If the bolt will still not lock back then push the Carrier Stop Button rearward and retry locking the bolt rearward. Use your eyes to verify that the gun is completely empty.

WARNING

Once you have stopped firing the auto loading shotgun, immediately push the cross trigger block safety back to the "on" or "safe" position. Then follow the unloading instructions above while keeping the muzzle pointed in a safe direction.

GAS SYSTEM ADJUSTMENT: The Model SPR 453 shotgun has a unique self-regulating gas system. It is preset at the factory to function reliably with a wide range of 12 gauge ammunition ranging from 12 Ga./2 ³/₄" (1 ¹/₄ oz.) shells to 12 Ga./3.1/2" shells. This system also allows you to fine tune the function of the shotgun with the gas system nut. By adjusting the gas system nut, you can make your shotgun function over the complete range of 12 Ga. ammunition and set the shotgun for optimum function for the user. The gas system nut allows you to customize the function of the shotgun to your requirements without additional parts or kits

GAS CYLINDER NUT: The gas cylinder nut is located under the barrel on the front end of the gas cylinder. (See **Picture 35**). The gas cylinder nut retains the valve spring with the valve, which provide the action of the shotgun with light loads as well as with heavy loads.

Firing Your Shotgun (cont'd)

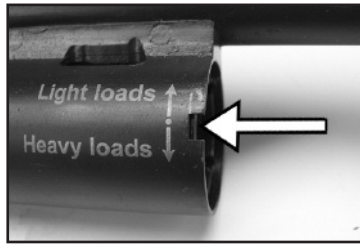

Picture 35

Note: For the first 100 rounds, use 1 1/4 oz. loads or greater for break-in. Your shotgun was set at the factory to use 12 Ga./3 1/2" steel shot to 12 Ga./2 3/4" (1 1/4 oz.). After break-in, if you wish to use lead or tungsten based shot 12 Ga./3 1/2" rounds, then you must adjust the gas cylinder nut two turns counter-clockwise. If you wish to use loads lower than 12 Ga./2 3/4" (1 1/4 oz.) you must adjust the gas cylinder nut as required by turning it clockwise.

Never adjust the gas cylinder nut more than two complete turns in any direction. For reference use the notch on front of the gas cylinder. The nut should be visible through the notch and at the most should fit flush the front end of the gas cylinder. To set the shotgun back to factory setting, see the mark on the gas cylinder and adjust as required. (See **Picture 35**).

Note: Screw the gas cylinder nut but do not detach the barrel from the receiver. (See **Picture 36**).

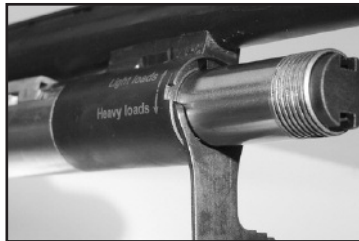

Picture 36

MAGAZINE PLUG PLACEMENT: The wooden or plastic rod enclosed with your shotgun is a magazine plug and can be placed inside the magazine tube spring from the cap end. The rod prevents the magazine follower from moving the full length of travel.

It is present for one round in the magazine without the plastic spring cap. You will see a mark on the rod which is where you would cut the rod if you want two rounds in the magazine without the plastic spring cap. If you want to use the plastic spring cap and the magazine plug you will have to cut the rod at the mark.

Instructions For Disassembly Of The Auto Loading Shotgun

1. Make sure the combination rifle/shotgun is unloaded (**FOLLOW UNLOADING INSTRUCTIONS**) and pointed in a safe direction.
2. Make sure the cross trigger block safety is engaged in the "ON" or "SAFE" position. (Red band will not show). (See **Picture 37**).



Picture 37

3. With the bolt in the forward position, unscrew the forend cap and remove the forend. Push the Carrier Stop Button rearward and move the to the rear slightly and hold it out of battery. Then grasp the barrel and remove the barrel by pulling the barrel and barrel extension out of the receiver. (See **Picture 38**).



Picture 38

4. Use the back end of an empty cartridge or a flathead screwdriver or your fingers to remove the Bolt Cocking Handle. Insert the screwdriver or back of empty cartridge into the notch and pry up handle and remove from the bolt or grasp the handle firmly and pull out and away from the receiver. (See **Picture 39**).



Picture 39

5. With the cocking handle removed from the bolt you now can grasp the gas piston and slide the bolt and action bar forward and remove the assembly from the magazine tube and receiver. Be careful because once the bolt is removed from the receiver all the pieces from the assembly are free to separate. We suggest you keep the gun with the bolt up when you remove the assembly does not separate. See locking block placement section. (See **Picture 40**).



Picture 40

6. The trigger assembly can be removed with the barrel and bolt removed or without the barrel and bolt removed. To remove the trigger assembly, remove the two pins that hold the trigger assembly in place and pull the trigger assembly from the receiver. The pins can be removed with a hammer and a punch. (See **Picture 41**).

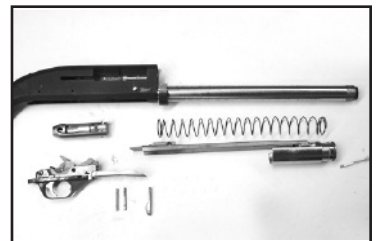

Picture 41

Manufacturer's Warning

This firearm was manufactured to properly perform with the original parts as designed. It is your duty to make sure any parts you buy are correctly installed and that neither replacements nor originals are altered or changed. Your shotgun has many parts that must relate correctly to other parts for safe and accurate operation. Putting a gun together wrong or with modified parts can result in a damaged gun, or personal injury or death to you or others. Always let a qualified gunsmith work on your gun or at least, check any work not performed by a gunsmith. Firearms safety is your primary concern. **THE GUN OWNER MUST ACCEPT FULL RESPONSIBILITY FOR THE CORRECT REASSEMBLY AND FUNCTIONING OF THE FIREARM AFTER ANY DISASSEMBLY OR REPLACEMENT OF PARTS.**

To Clean and Maintain Your Shotgun

- A. Follow procedures for unloading shotgun as described previously.
- B. Follow procedures for disassembly of shotgun as described previously.
- C. Materials needed to clean this shotgun are: a cleaning rod, cotton bore patches, brass bore brush, powder solvent (such as Remington BriteBore™), a small soft brush and good quality gun oil (such as Rem® Oil).

WARNING

Lead or lead compounds are known to the State of California to cause cancer, birth defects, reproductive toxicity, and other serious physical injury. Those who clean firearms should take protective measures to avoid contact or exposure to such chemicals.

- D. Using the bore brush with powder solvent, scrub the interior of the barrel and chamber to remove any powder and lead residue in the bore. Always and lastly, swab the interior of the barrel with a cotton patch with gun oil to coat and protect the bore and chambers from rust and corrosion.
- E. Any powder fouling on the firing wall, barrel, etc. can be easily cleaned with a brush and powder solvent.
- F. All external surfaces should be wiped down with a light coat of rust preventative. Avoid using too much oil as powder, dust or other foreign material may get trapped in the oil. This could lead to congealed deposits which may interfere with the safe and reliable operation of this shotgun.
- G. **USE CAUTION** while using solvents in gun bore cleaning. Prolonged or excess contact with solvents can damage the gun's bluing and finish. Be sure to wipe away all excess solvent and then lubricate with oil.
- H. A gun should be cleaned after firing. In addition, external parts should be wiped with an oiled cloth after handling. A light oil is ordinarily all that is necessary in cleaning if the gun has not been fired or fired very little. If a gun is used frequently, it must be cleaned after each firing and regularly serviced by a professional gunsmith. If the gun has been stored, remove all excess oil and/or grease before firing. Always check to be sure that no cleaning patch or other obstruction remains in the bore or chambers before firing.

To Clean and Maintain Your Shotgun (cont'd)

GAS PORTS: The two holes in the barrel gas porting ring are the gas ports which regulate the auto-loading function of the shotgun. (See **Picture 42**). These holes must remain open and clear for the shotgun to function properly. Make sure these holes are cleaned after each use. Also clean the barrel gas porting ring.

GAS PISTON ASSEMBLY: The gas piston assembly is on the magazine tube. (See **Picture 43**). The gas piston assembly must be cleaned and lightly oiled after each use.



Picture 42

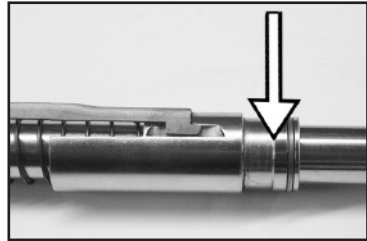

Picture 43

DANGER – Ammunition Warning

Firearms may be damaged and serious personal injury or death to the shooter or bystanders may result from any condition which contributes to the generation of excessive pressure or uncontrolled release of gas within the firearm. Such adverse conditions can be caused by bore or chamber obstructions, propellant powder overloads or by defective, incorrect or improperly loaded and assembled cartridge components. Even the strongest firearm can be blown up as a result of excessive pressure. It is extremely dangerous to use a cartridge whose pressure is greater than that developed by cartridges loaded to industry standards.

Ammunition (Cartridges) Notice

We specifically disclaim responsibility for any damage, injury or death occurring in connection with or as the result of the use of the shotgun with faulty, non-standard, remanufactured, hand loaded or reloaded ammunition or with cartridges other than factory cartridges for which the shotgun was originally chambered.

Lubrication Warning

Firing a shotgun with oil, grease or any other material even partially obstructing the bore may result in damage to the shotgun and personal injury to the shooter and those nearby. Do not spray or apply lubricants directly on ammunition. If the powder charge of a cartridge is affected by the lubricant, they may not fully ignite yet the energy from the primer and/or powder may still be sufficient to push the projectile or wad into the bore where it may become lodged. Firing a subsequent cartridge into the obstructed bore will damage the shotgun and may cause personal injury to the shooter and those nearby. Use lubricants properly. You are responsible for the proper care and maintenance of your firearm and ammunition.

PARTS AND SERVICE

To Order Parts

ALL PARTS ARE SUBJECT TO A \$10.00 CHARGE FOR SHIPPING AND HANDLING. Some parts are restricted and may only be installed by returning the shotgun to us. When ordering parts, please state the Model, Gauge, Serial Number, and Finish Color. For parts information, call (321) 639-1432.

Service

To obtain information about returning your shotgun for service or repairs, call (321) 639-1432.

One Year Limited Warranty

This shotgun is warranted to the original retail customer for one year from the date of retail purchase against defects in material and workmanship. All parts and labor or replacement at our option are covered. The wood stock is not covered by the one year warranty. The warranty on the wood stock is 60 days and is limited to the original retail customer and extends 60 days from the date of retail purchase and covers only manufactured and material defects. Transportation to and from our repair facilities, government fees, damage caused by failure to perform normal maintenance, sales outside the United States, damage caused by use of high velocity, high pressure, reloaded or other nonstandard ammunition, or by any unauthorized repair, modification, misuse, abuse or alteration of the shotgun is not covered by this Limited Warranty.

Implied Warranty

ANY IMPLIED WARRANTIES, INCLUDING THE IMPLIED WARRANTIES OF MERCHANT ABILITY AND FITNESS FOR A PARTICULAR PURPOSE, ARE LIMITED IN DURATION TO ONE YEAR FROM THE DATE OF ORIGINAL RETAIL PURCHASE. SOME STATES DO NOT ALLOW LIMITATIONS ON HOW LONG AN IMPLIED WARRANTY LASTS, SO THE ABOVE LIMITATION MAY NOT APPLY TO YOU.

To the extent any provision of this warranty is prohibited by federal, state, or municipal law, which cannot be pre-empted, it shall not be applicable. This warranty gives you specific legal rights, and you may also have other rights which may vary from state to state.

To obtain warranty service, send your shotgun with proof of retail purchase, freight prepaid to:

REMINGTON I.S.P.
c/o USSG
402 Richard Road
Rockledge, FL 32955

NOTICE: It is illegal to ship a firearm with ammunition in the firearm or in the same packaging. Firearms and ammunition must be shipped separately. For information about shipping ammunition, call (321) 639-1432.

Your Owner's Manual

Always keep this manual with your firearm. Make sure you understand all the warnings, operation instructions and safety procedures. When you lend, give or sell the firearm, be sure this manual goes with it. You can get a copy of this manual from Remington upon request.

PARTS LIST

Model SPR453 Auto Loading Shotgun Exploded View

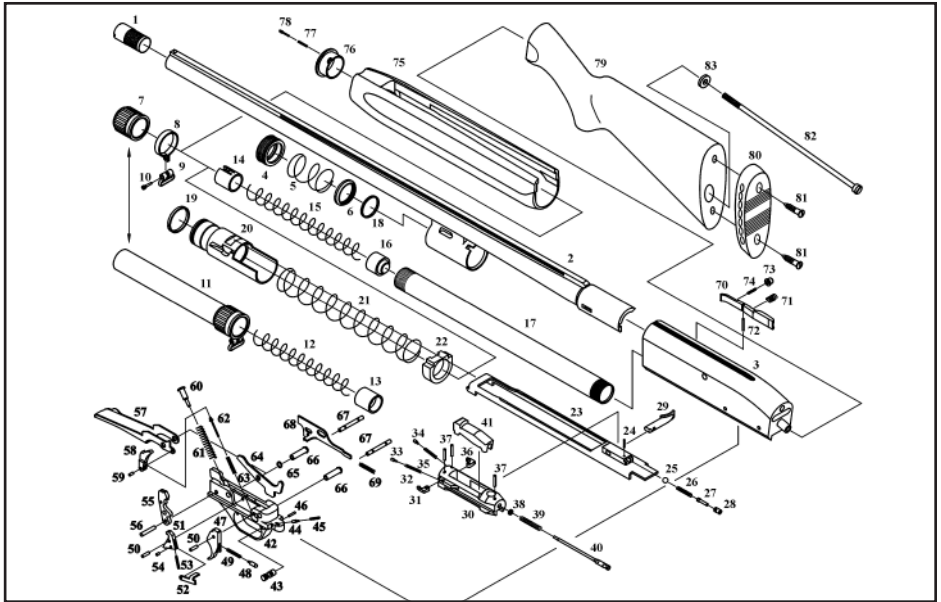

- | | | |
|------------------------------------|---------------------------------------|---------------------------------|
| 1.choke tube | 30.bolt | 58.carrier latch dog |
| 2.barrel | 31.left extractor | 59.carrier latch dog pivot |
| 3.receiver | 32.left extractor spring | 60.hammer plunger |
| 4.gas cylinder nut | 33.left extractor plunger | 61.main spring |
| 5.valve spring | 34.right extractor plunger | 62.carrier latch dog plunger |
| 6.valve | 35.right extractor spring | 63.carrier latch spring |
| 7.forend cap | 36.right extractor | 64.disconnecter |
| 8.sling swivel band | 37.firing pin retaining pin | 65.disconnecter busing |
| 9.sling swivel ring | 38.firing pin retractor spring washer | 66.pin tube |
| 10.sling swivel screw | 39.firing pin retractor spring | 67.trigger housing retainer pin |
| 11.magazine tube extension | 40.firing pin | 68.carrier stop catch |
| 12.magazine tube ext. spring | 41.locking block | 69.carrier stop catch spring |
| 13.magazine tube ext. insert | 42.trigger housing | 70.shell stop |
| 14.magazine spring retainer | 43.safety | 71.shell stop spring |
| 15.magazine spring | 44.safety plunger | 72.shell stop pivot |
| 16.magazine follower | 45.safety spring | 73.bolt release button |
| 17.magazine tube | 46.pin | 74.bolt release button spring |
| 19.external seal | 47.trigger | 75.forend |
| 20.piston/action bar sleeve | 48.trigger plunger | 76.cap retaining pin bushing |
| 21.recoil spring | 49.trigger spring | 77.cap retaining pin spring |
| 22.forend support | 50.pivot | 78.cap retaining pin |
| 23.action bar assembly | 51.sear | 79.buttstock |
| 24.pin | 52.trigger bar | 80.buttplate |
| 25.bolt cocking handle detent ball | 53.sear spring | 81.buttplate woodscrew |
| 26.spring | 54.trigger bar pivot | 82.buttstock screw |
| 27.plunger | 55.hammer | 83.buttstock washer |
| 28.bushing | 56.hammer pivot | |
| 29.bolt cocking handle | 57.carrier latch | |

Optional Choke Tubes



WARNING

Never install or remove choke tubes while the firearm is loaded. Only install or remove choke tubes with the firearm unloaded, the action open and the trigger block safely engaged.

Screw in Chokes Symbols/Markings (This is an option – not all Model 100 shotguns have this feature)

The end of the choke tubes are marked with slashes to identify the choke construction:

- / - Full
- // - Improved Modified
- /// - Modified
- //// - Improved Cylinder
- CI - Cylinder



WARNING

MAKE SURE YOU FULLY TIGHTEN THE CHOKE TUBE.

Shooting with a loose choke tube can cause damage to your shotgun.

Additional Information On Screw Choke Tubes:

- A. Only tighten or loosen choke tubes with flat key wrench supplied with shotgun. Note: wrench (and extra choke tube or tubes if supplied) are under the cardboard in front of the shotgun receiver in the box.
- B. Never shoot the shotgun with a partially installed choke tube.
- C. Model SPR 453 auto loading shotguns are available with fixed choke or screw choke barrels. There are two types of screw chokes available: lead shot choke tubes and steel shot choke tubes. When installed, steel shot choke tubes protrude approximately $\frac{3}{4}$ " from the muzzle end of the barrel and the mating lip will be flush with the end of the barrel. When installed, lead shot choke tubes fit flush with or slightly below the muzzle end of the barrel. If you have lead shot choke tubes and intend to shoot steel shot cartridges or slugs, then you must use only the IC or Cylinder tubes. DO NOT fire steel shot or slugs in Modified, Improved Modified or Full lead shot choke tubes. If you have steel shot choke tubes, you may fire steel shot cartridges through any of those choke tubes. DO NOT fire slugs in Modified, Improved Modified or Full lead shot choke tubes or steel shot choke tubes.
- D. Correctly installed choke tubes: Lead shot choke tubes should fit flush or slightly below the muzzle end of the barrel. Steel shot choke tubes will protrude out from the barrel about $\frac{3}{4}$ " and the mating lip will be flush with barrel end.
- E. Before using the shotgun make sure that the choke tubes are installed correctly.
- F. Keep choke tubes lubricated and installed. Never fire the gun without a choke tube installed. Handle choke tubes carefully since the leading edge is very thin.

Additional Information On Screw Choke Tubes: (cont'd)

Notes on Shot Material and Chokes:

1. Shells using Bismuth® or Tungsten-Matrix® shot are subject to the same barrel and choke tube limitations as lead shot. Shells using Tungsten-Iron shot or Hevi-Shot® are subject to the same barrel and choke tube limitations as steel shot.
2. On fixed choke guns, shells loaded with steel, Tungsten-Iron or Hevi-Shot® should be fired only in IC or Cylinder barrels. DO NOT fire steel, Tungsten-Iron or Hevi-Shot® shells in fixed barrels with Modified, Improved Modified or Full choke barrels. Lead, Bismuth® and Tungsten-Matrix® may be fired in all fixed choke barrels.
3. On fixed choke guns, slugs may be fired in only IC and Cylinder barrels. DO NOT fire slugs in fixed choke barrels with Modified, Improved Modified or Full chokes.

If you would like to buy extra choke tubes (skeet, trap, extra full, etc.) call (321)-639-1432.



WARNING

Children are attracted to and can operate firearms that can cause severe injuries or death. Prevent child access by always keeping guns locked away and unloaded when not in use. If you keep a loaded firearm where a child obtains and improperly uses it, you may be fined or sent to prison.



ADVERTENCIA

A los niños les atraen las armas de fuego y los pueden hacer funcionar. Ellos pueden causarse lesiones graves y la muerte. Evite que los niños tengan acceso a las armas de fuego guardándolas siempre con llave y descargadas cuando no las esté utilizando. Si usted tiene un arma de fuego cargada en un lugar en que un niño tiene acceso a ella y la usa indebidamente. Le pueden dar una multa o enviarlo a la cárcel.

REMINGTON I.S.P.
c/o **USSG**
402 Richard Road
Rockledge, FL 32955

Manufacturer:

Izhevsky Mekhanichesky Zavod
8, Promyshlennaya str.,
426063 Izhevsk, Russia

Remington®

Remington is a trademark registered in the United States Patent and Trademark Office by Remington Arms Company, Inc.