

Charles Daly®

INSTRUCTION
MANUAL
FOR
MODEL 206
OVER & UNDER
SHOTGUN

**READ THE INSTRUCTIONS AND
WARNINGS IN THIS MANUAL CAREFULLY
BEFORE USING THIS FIREARM**

FIREARMS SAFETY

At Charles Daly, we believe that safe firearms handling is the most important consideration of anyone who uses firearms and ammunition. Please take a few minutes to thoroughly read and understand this instruction manual included with this shotgun.

You should completely understand this manual before you practice loading, unloading and firing with live ammunition.

Remember, firearms safety does depend on you!

Serial No. _____

Date Purchased: _____

Purchased From: _____

THIS MANUAL CONTAINS

1. Important warnings, which should be read and understood before using this firearm. **SAFE GUN HANDLING IS YOUR PERSONAL RESPONSIBILITY AT ALL TIMES.** Disregarding warnings in this manual may result in injury or death to you and others and damage to property.
2. Directions and procedures for handling loading, firing and unloading.
3. Instructions for care, cleaning, repair, and service of this shotgun.

This instruction and safety manual is designed to help you in learning how to properly use and care for your Charles Daly Over and Under shotgun. Only when you are certain you have fully familiarized yourself with the function of your firearm should you practice loading, unloading and firing with live rounds of ammunition.

This instruction manual should always accompany this firearm, and be transferred with it upon change of ownership. Should you ever need to replace it, this manual is available FREE upon request from Charles Daly.

DISCLAIMER OF LIABILITY

Charles Daly and K.B.I. Inc., shall not be responsible for product malfunctioning or for physical injury, death or damage to property resulting from either intentional or accidental discharge of this firearm, its criminal or negligent use, improper or careless handling, unauthorized modifications or alteration, use of defective or improper or hand-loaded or (replaced) ammunition, or from its use for purposes or subjection to treatment for which it was not designed. For your safety, use only original high quality commercially manufactured ammunition in good condition that is appropriate to the caliber/gauge of your gun. Charles

Daly shall not be responsible for product or its result from use of defective, improper or reloaded ammunition.

WARNING – LEAD EXPOSURE

Discharging firearms in poorly ventilated areas, cleaning firearms, or handling ammunition may result in exposure to lead and other substances that may cause birth defects, reproductive harm, and other serious physical injury. Have adequate ventilation at all times. Wash your hands thoroughly after exposure. Shooting or cleaning guns may expose you to lead.

WARNING:

Prior to removing this gun from its packaging, and prior to loading and firing, carefully and thoroughly read the entire instruction manual which gives advice on the gun's proper handling and functioning. However, your safety and that of others (including your family) depends on your responsible compliance with that advice. If unfamiliar with firearms seek supervised instruction.

FIREARMS SAFETY IS YOUR RESPONSIBILITY.

GENERAL SAFETY WARNINGS

1. Careless and improper handling of this gun could result in unintended discharge causing injury, death or property damage. Safety must be the first and constant consideration when handling a firearm and ammunition.
2. This shotgun was designed to function properly in its original condition. Alterations can make it unsafe. Do not alter any part or add or replace parts.
3. Shotguns should only be carried with the action open and chambers empty to prevent accidental discharge.
4. **Always handle and treat your gun as if it were loaded** so you never fire it accidentally when you think it is

unloaded. Never take anyone's word it is unloaded. Always check it yourself with your fingers off the trigger and the gun pointed in a safe direction.

5. Never place your finger inside the trigger guard unless you intend to fire.
6. Water, snow, mud, excessive lubricating oil or grease or any other material can obstruct the barrel of your gun. Always check the barrel of your firearm for obstruction before loading and firing. Clean a fouled gun immediately to ensure its correct and safe function.
7. **Keep the gun's muzzle pointed in a safe direction at all times.** Never let the muzzle of a firearm point at any part of your body, another person or at anything you do not intend to shoot. Always be certain of your target before firing.
8. **UNLOAD ALL FIREARMS WHEN NOT IN USE. NEVER STORE A LOADED FIREARM.** Firearms and ammunition should be safely stored separately so that they are inaccessible to children or unauthorized users.
9. Your Charles Daly Over and Under shotgun has been supplied with a safety lock. Read the supplied pamphlet Gun Locks, Instruction and Use.
10. Always make sure your gun is not loaded before cleaning, storing, or handing it to another person.
11. Always wear safety glasses while shooting to protect your eyes from injury by gun powder, gas, lubricant, dirt or metallic particles, carbon residue, sparks or other debris.
12. Always wear ear protection when shooting, especially on a range. Without ear protection, the noise from your gun, and other guns close to you, could leave a "ringing" in the ears for some time after firing. Repeated exposure to shooting noise could result in permanent hearing loss.

13. Never climb a tree, fence or wall while carrying a loaded firearm.
14. Don't shoot at a hard surface, or at water. A pellet may ricochet and travel in unpredictable directions to strike you or an object you cannot see.
15. Firearms and alcohol don't mix. Never drink alcoholic beverages or take drugs before or during shooting, as this constitutes criminal disregard for your safety and that of others. Never use a gun while you are taking medication unless you have checked with your doctor to ensure your fitness to handle your gun safely.
16. If you have any doubts about your ability to handle or use this shotgun safely, seek supervised instruction.
17. **Horseplay has no place around firearms. Guns can't think – you can!**
18. **Remember, safety is your responsibility, be a safe shooter.**
19. FOLLOW THE LAW: Obey all local, state and federal laws regarding storage, shooting and transporting your firearm.

NOMENCLATURE

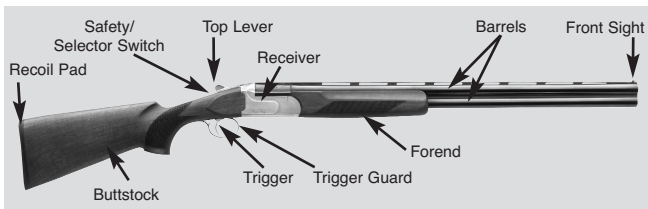

Directions for Assembly

⚠ WARNING: Read and understand all instruction and warnings in this manual BEFORE using this shotgun. It is important to learn the parts of your shotgun and their functions before using this firearm.



Before assembling the shotgun, make sure there are no shotshells in the chambers.

1. Remove the forend from the barrel by pulling the forend release lever (Fig 1.) away from the forend and pivot the forend away from the barrel. (Fig. 2)
2. Apply a small amount of high quality lubricant to all surfaces on both sides marked with **red arrow** in Fig 3.

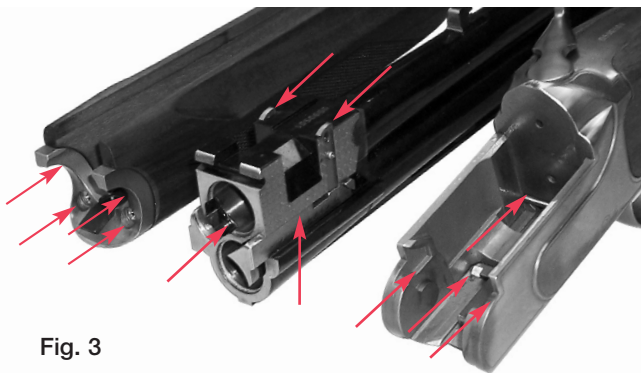

3. Attach barrels to the action by pushing the top lever to the right and engaging the dual hinge pin surfaces at the forward portion of the receiver, with the hinge pin bearing notches on each side of the barrel. Hold the barrels with the



Fig. 4

Fig. 5A



Fig. 5B

muzzle at a downward angle with respect to the receiver. Once the bearings are properly seated, lift up on the barrels and close the action. (Fig 4)

4. When the barrels are closed properly against the receiver, the Top Lever will return toward the center of the action. (Fig. 5A)



Fig. 6

5. Attach the forend to the barrels by placing the metal part of the forend assembly against the receiver. Pivot forend toward the barrel to the closed and locked position against the barrels. (Fig. 6)

OPERATING INSTRUCTIONS

⚠ WARNING: Read and understand all instruction and warnings in this manual BEFORE using this shotgun. It is important to learn the parts of your shotgun and their functions before using this firearm.

TOP LEVER

The Top Lever controls the locking of the breech of the

barrels to the receiver. To open the gun, move the Top Lever to its extreme right hand position and ease down the barrels. The Top Lever will remain in the “OPEN” position until the barrels are again closed and locked. The Top Lever will then automatically return toward the center position (Fig. 5A) With the barrel removed from the receiver, the Top Lever can be returned to the center position by depressing the Top Lever Latch. (Fig. 5B) When the barrels are removed from the receiver, the Top Lever should always be returned to the center position to prevent damage and especially during transportation.

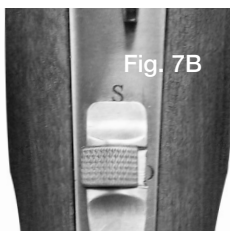
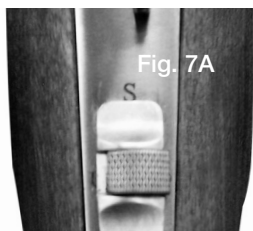

SAFETY / BARREL SELECTOR

Safety is first and foremost when handling any firearm. To engage the safety, slide the Safety Button fully rearward. There is a visible “S” to help guide you. To disengage the safety in order to fire the shotgun, slide the Safety Button fully forward. Always keep the safety in the “Safe” position until you are ready to fire the shotgun.

Field 206 models are equipped with an automatic safety. When the top lever is moved to the extreme right hand position, the Safety Button will automatically be moved to the rear position or “Safe” position. The Sporting and Trap 206 models are equipped with only a manual safety which requires the Safety Button to be manually moved rearward to the “Safe” position to engage the safety from the fire position.

⚠ WARNING: Sporting and Trap 206 Models are equipped with a manual safety only!

On Charles Daly 206 Over and Under shotguns, the safety also performs the function of barrel selector. However, to perform this function the Safety Button must first be in the "Safe" position with the "S" visible. Once the safety is engaged, you can select which barrel will fire first by sliding the Selector Button to either the right or left. With the Selector Button moved to the right, the bottom barrel will fire first. (Fig. 7A) When the Selector Button is moved to the left position, the top barrel will fire first. (Fig. 7B)

⚠ WARNING: Make sure you do not disengage the safety while you are selecting which barrel to fire first.

SELECTIVE AUTOMATIC EJECTORS

Your gun is equipped with automatic ejectors. When you open the breech of the shotgun, they will automatically eject a fired case and partially extract any unfired shell for easy removal by hand. (Fig 8)

Fig. 8

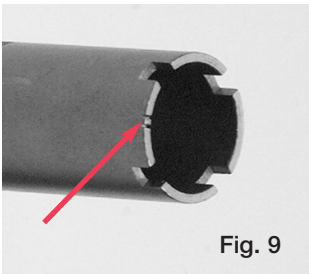
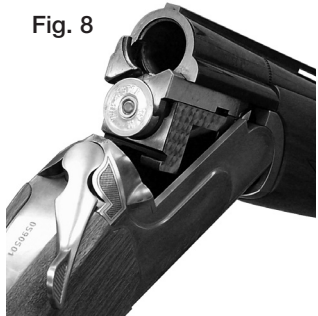

Fig. 9

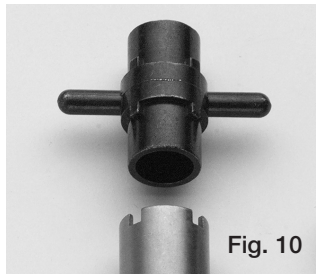

Fig. 10

MULTI CHOKE TUBES

This Charles Daly Over and Under shotgun is equipped with interchangeable multichoke tubes. The notches on the top of the tube can identify the choke tube. (Fig. 9)

STEEL SHOT WARNING

Steel shot (up to and including size 2 shot) should not be fired through your shotgun with a choke tighter than modified. If target than size 2 shot is used, the tightest choke used should be an improved cylinder.

Choke Type	Notches
Cylinder	
Skeet	
Improved Cylinder	
Modified	
Improved Modified	
Full	

 **WARNING:** Periodically check to be sure that choke tubes are tight and properly seated.

Before changing a choke tube, always make sure that your shotgun is unloaded and the safety is in the “Safe” position. To change the choke tubes, use the choke tube wrench. The wrench and additional chokes are supplied in the shotgun box. Insert the wrench into the recessed space of the tube and unscrew counterclockwise. Insert the desired choke tube and seat with the wrench in the reverse, or clockwise, direction. (Fig. 10)

 **WARNING. NEVER FIRE YOUR SHOTGUN WITHOUT A CHOKE TUBE INSTALLED.** This could damage the choke tube threads on the inside of the barrels.

AMMUNITION

Use only high quality ammunition specifically designed for

your gauge of shotgun. Each barrel is marked with the size of shotshell it will accept. If the barrel is marked “3” it will accept 3” and 2 3/4” shotshells. We do not recommend using slugs in this Over and Under shotgun.



Fig. 11

⚠ WARNING: THE ACCIDENTAL LOADING AND

DISCHARGE OF SHELLS OF THE WRONG GAUGE IN YOUR GUN CAN RESULT IN DAMAGE TO YOUR GUN AND INJURY TO THE SHOOTER OR OTHERS. To be safe, carry only the proper gauge ammunition with you when shooting.

LOADING

⚠ WARNING: Read and understand all instructions and warnings in this manual BEFORE using this shotgun. It is important to learn the parts of your shotgun and their functions before using this firearm. Be sure of your target and whats beyond before firing.

To load your Charles Daly Over and Under shotgun, be sure the safety is in the “Safe” position, open the action by moving the top lever to the right. This will cause the lock to disengage and allow the barrels to pivot downward exposing the chambers. Insert shotshells of the appropriate gauge and size into the chambers. (Fig 11.) When you are finished loading the chambers, close the breech by pivoting the barrels against the action. The top lever will return toward the center position when the breech is closed and locked.

FIRING

After you've inserted the shotshells into the chambers and have closed and locked the breech, your shotgun is ready to fire. Disengage the safety by pushing the safety button fully forward.



Fig. 11

Pull the trigger and the selected barrel will fire.

After firing, allow the trigger to return to the fully forward position before firing again.

UNLOADING

⚠ WARNING: Read and understand all instruction and warnings in this manual BEFORE using this shotgun.

Always keep the shotgun pointed in a safe direction and the safety in the “safe” position.

Before unloading, check to assure that the safety is in the “Safe” position. Open the action by pushing the top lever all the way to the right and pulling the barrels downward fully. This will eject empties and elevate any loaded or unfired shells in the chambers. Remember this shotgun is fitted with selective automatic ejectors and any fired shells will be ejected from the gun when you break open the action. Be careful of these cases exiting the action.

DISASSEMBLY

⚠ WARNING: Read and understand all instructions and warnings in this manual BEFORE using this shotgun.

Always make sure the shotgun is completely unloaded before disassembly.

Disassemble, clean and oil your shotgun at regular intervals or when it has been exposed to sand, water or other adverse conditions.



Fig. 13

To disassemble your shotgun

1. Remove the forend by pulling the forend release lever away from the forend, and pivoting the forend away from the barrel.
2. Push the top lever to the right to disengage the action.
3. Remove the barrel assembly.

Further disassembly is not recommended and not necessary for regular maintenance. (Fig.13)

CAUTION: Always unload your gun and store it and ammunition separately in locked receptacles out of children's reach and sight, minimizing the risk that the gun and ammunition could be easily available for loading and firing.

USE YOUR SHOTGUN CAREFULLY AND SAFELY.

SERVICE INSTRUCTIONS

Limited Lifetime Repair Policy

Our Limited Lifetime Repair Policy covers this Charles Daly Over and Under shotgun. Charles Daly will repair it, at no

cost to you, for as long as you own your Charles Daly firearm; provided you have registered your warranty with Charles Daly and that no service is performed on your firearm by anyone other than the Charles Daly Service Department.

If your Charles Daly firearm does require service, contact our service department by email, letter, fax or telephone. If you ever should have to send your shotgun back for repair please follow these instructions: make absolutely certain it is unloaded. Do not send ammunition with your shotgun. Remove any accessories. Please package the gun securely (be certain gun parts cannot shift during shipment) in a suitable shipping container.

Include with your firearm a clear description of the problem and service you wish us to perform. Please give us a clear ship-to address, (no P.O. Box numbers) your daytime phone number and if possible a fax number and email address. Please place your correspondence inside the package. If you have any questions, please call us at 717-540-4645 or email us at service@CharlesDaly.com.

The Limited Lifetime Repair Policy does not cover repairs related to unreasonable use, corrosion, failure to provide proper maintenance, damaged or shopworn display guns, gun barrels damaged by an obstructed bore, guns damaged in shipment due to improper packing and handling, or wear of any parts including finishes of metal, wood camo, or chrome. You must mail in the warranty registration card that comes with your firearm, or register your warranty online to be covered under this Lifetime Repair Policy. If you do not register your warranty, your purchase will still be covered under our traditional Standard Warranty.

CHARLES DALY STANDARD WARRANTY

Your Charles Daly firearm is warranted against defects in materials and/or workmanship for one year from date of original new gun retail purchase.

This warranty does not cover repairs related to unreasonable use, corrosion, failure to provide proper maintenance, damaged or shopworn display guns, gun barrels damaged by an obstructed bore, guns damaged in shipment due to improper packing and handling, or wear of any parts including finishes of metal, wood, camo or chrome.

Unauthorized alterations or service not approved or performed by Charles Daly, or the use of handloaded, reloaded or other non-SAAMI standard ammunition will also void all warranties. Charles Daly reserves the unconditional right to inspect any firearm before making any repairs or adjustments under this warranty.

Under no circumstance shall Charles Daly be liable for consequential or incidental damages or injury. Some states do not allow the exclusion of consequential or incidental damages so the above limitation may not apply to you.

To order parts call us at 1-866 DALY-SVC (1-866-325-9782) or you may fax your order. You'll be asked to provide your name, address, and city, state, zip and phone number as well as the firearm model #, serial #, caliber, finish, part# and part name. We have a minimum handling charge. We accept major credit cards, personal checks and money orders.

For further information, contact K.B.I. Inc., service department at 717-540-4656 or write to K.B.I. Inc., P.O. Box 6625, Harrisburg, PA 17112

NOTES

Charles Daly Model 206 Over & Under Shotgun Parts List

CD Part #	Part Description	CD Part #	Part Description	CD Part #	Part Description
1	Stock	23	Selector Button	48	Ejector Spring
2	Stock Bolt	24	Top Lever Spring Guide	49	Ejector Spring Guide
3	Stock Bolt Washer		Plunger	50	Right Ejector
4	Stock Bolt Lock Washer	25	Top Lever Spring	51	Left Ejector
5	Recoil Pad	26	Top Lever Spring Stop	52	Ejector Catch Plate Spring
6	Recoil Pad Screw	27	Top Lever Spring Guide	53	Ejector Catch Plate Retainer
7	Receiver	28	Bottom Plate Back Pin	54	Ejector Catch Plate R.H.
8	Hammer Cocking Rod R.H.	29	Bottom Plate	55	Ejector Catch Plate L.H.
9	Hammer Cocking Rod L.H.	30	Trigger Guard	56	Fiber Optic Front Sight
10	Locking Plate	31	Trigger Guard Pin	57	Choke Tube
11	Top Lever	32	Trigger	59	Forend
12	Top Lever Pin	33	Trigger Pin	60	Forend Nut
13	Bottom Plate Front Pin	34	Inertia Block Spring	61	Forend Iron Hook
14	Firing Pin Spring	35	Inertia Block Spring Pin	62	Forend Bolt
15	Firing Pin	36	Inertia Block	63	Forend Catch Plate
16	Firing Pin Retainer Bushing	36a	Inertia Block Pivot Pin	64	Forend Catch Spring
17	Sear Spring	37	Hammer Cocking Cam	65	Forend Catch
18	Sear Spring Pin	38	Hammer Cocking Cam Pin	66	Forend Catch Pin
19	Sear	39	Hammer Spring	67	Forend Catch Plate Screw
20	Sear Pin	40	Hammer Spring Guide Rod	68	Forend Iron Plate
21	Safety/Selector Spring	41	Hammer R.H.	69	Forend Plate Front Screw
22	Safety Button	42	Hammer L.H.	70	Forend Plate Back Screw
22a	Selector Button Spring	43	Hammer Pin		
22b	Detent Ball	44	Top Lever Latch Spring		
22c	Safety/Selector Button Bushing Pin	45	Top Lever Latch		
		47	Barrel Assembly		

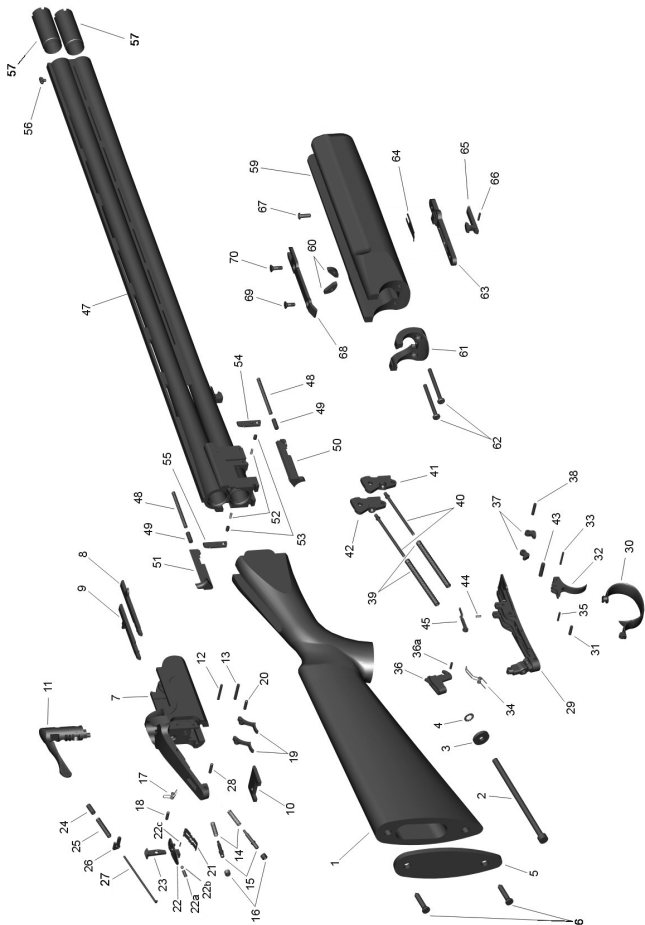

www.charlesdaly.com

Discharging firearms in poorly ventilated areas, cleaning firearms, or handling ammunition may result in exposure to lead and other substances known to cause birth defects, reproductive harm, and other serious physical injury. Have adequate ventilation at all times. Wash your hands thoroughly after exposure. Shooting or cleaning guns may expose you to lead.

Charles Daly®

P.O. Box 6625

5480 Linglestown Road

Harrisburg, PA 17112

Tel. (717) 540-8518 Fax. (717) 540-8567

04222009