

2009 WILSON COMBAT®



31 YEARS, WITHOUT COMPROMISE

\$5.00

Dear Friends,

It's been 32 years since the first custom firearm with my name on it was delivered. I made absolutely sure that first customer got exactly what he had specified, built to the highest standards with state-of-the-art materials. That pistol was hand-built, each part custom matched and fitted to work with its corresponding parts exactly as John Browning envisioned back in the early 1900's. It exceeded that shooter's expectations, and although he doesn't shoot competition anymore, we're still friends, as I am with many of my first customers. At Wilson Combat®, we still hand-build our pistols, still hand-match and hand-fit every part. The Wilson Team includes the best-trained and most experienced Master Pistolsmiths anywhere, every day defining the art and science of custom gun building. Our custom shop manager Vic Tibbets is himself a master pistolsmith who has built hundreds of Wilson Combat® Super grades in the past. This knowledge and experience allows him to train and mentor our staff of 34 custom gunsmiths.

I've shot competitively over much of the world and won my share of matches. I'm real proud of those wins, but nowhere near as proud as I am of the simple fact that my first customer received what he expected. And that my next customer is going to receive what he expects, along with every customer in between. It's not a perfect world, and neither Wilson Combat® nor any one else can build a perfect machine. But here's what I promised that first customer, and promised every one I've welcomed to the family of Wilson gun owners - If it's not right, I'll make it right, at my expense. From now on. That's the most I can do, and no one should expect you, the investor in a custom firearm, to accept anything less.

When your pistol leaves our shop at Wilson Combat®, it's had over eighty rounds fired through it, using at least three different kinds of ammo. Not machine-tested, but hand-fired by an experienced shooter - with the actual magazines that are going to be delivered with your pistol. If any malfunction, anything less than anticipated performance occurs, the pistol goes back to the shop and is fine-tuned. Then it goes back to the firing line, where the live firing tests start again. We either get it right, or the pistol stays with us. We include the final sight-in target, yes, we sight them in, with the weapon, demonstrating the accuracy you can expect from your pistol.

We have approached the long-gun market in the same manner. If you haven't tried our tactical rifle yet, or come to rely on the superb defensive shotguns from our ScattergunTechnologies™ group, then stop by one of our dealers and get your hands on one. You'll find the same exacting workmanship, quality materials, and superb fit and finish as our pistols - plus the same absolute guarantee and customer service you've come to expect from us. And we offer full custom options and build-selections

to deliver the exact weapon you need. Also, by mid-2009 we will be offering our first Wilson Combat® bolt action rifles as well.

If you are an owner of another brand of 1911 or AR, we offer specialized tuning or even complete rebuilds, to bring out every bit of the performance and reliability that your weapon can possibly provide. No one knows 1911's like we do; no one builds a better long gun than we do; and no one will work as hard to satisfy you as we will.

We're continuing to increase our accessory and parts selection across all lines. We've not only added more choices, but we continue to upgrade the parts we supply. Whether it's a drop-in part, or something that needs to be custom-fit to your gun, if it's from Wilson you can rely on receiving the highest value in the industry. The parts we sell are the same ones we use in our guns, which means they are continually tested, refined, and compared to everything on the market. If we find a better part anywhere else, we adopt it and offer it to our customers. We're not happy unless you're happy. We don't settle for second-best, and we don't expect you to, either.

At Wilson Combat® / ScattergunTechnologies™, we're proud of our position as the acknowledged leader in customer satisfaction and quality products. We work hard to maintain the reputation we've built over the last thirty years, and continue to invest in the human resources, training, capital equipment, research and development to stay on top. We have added new leadership personnel in engineering, manufacturing management, materials, research, design, operations, and business development. One of our goals is to be a little better every single day, and we work hard to meet that goal.

If you've been waiting to try one of our products, call one of our Customer Service representatives and let them show you how easy it is to join our family of satisfied owners. Wilson Combat® / ScattergunTechnologies™ would not exist without you, our satisfied customers. We sincerely appreciate you selecting us to be On Your Side®, and look forward to serving your firearm needs with reliable and accurate products we can all be proud of.

Bill Wilson
Wilson Combat® / ScattergunTechnologies™

4	Custom Process	30	Bullet Proof® Parts
6	What The Experts Say	31	Fire Control / Safeties
8	Classic Supergrade	32	Fire Control / Safeties / Frame Parts
9	Tactical Supergrade	33	Frame Parts
10	Supergrade Compact	34	Frame Parts / Slide Parts
11	CQB	35	Slide Parts
12	CQB Elite	36	Slide Parts / Springs
13	CQB Compact	37	Springs / Shok-Buffs® / Maintenance
14	Tactical LE	38	Maintenance / Range Gear
15	Professional	39	Sights
16	Classic	40	Grips
17	Protector®	42	1911 Replacement Parts
18	Tactical Elite	43	Non-1911 Parts
19	Stealth (S.D.S.)	44	Custom Leather
20	Elite Professional	46	Standard Model
21	Sentinel®	47	Border Patrol
22	Bill Wilson Carry Pistol	48	Remington® Steal
23	Hunter	49	Shotgun Parts
24	Custom Upgrades	50	UT-15 Urban Tactical
25	Customer Gunwork	51	M-4T M4 Carbine
26	Armor-Tuff®	52	TL-15 Tactical Lightweight Carbine
27	ETM Magazine	53	SS-15 Super Sniper Tactical Rifle
28	Series 47 Legendary Magazines	54	Rifle Parts
		55	Ordering Information

More Info And Additional Products



www.wilsoncombat.com
800-955-4856

When you purchase a firearm with the Wilson Combat® or ScattergunTechnologies™ name on it, you're not buying "just another gun." All Wilson Combat®/ ScattergunTechnologies™ firearms are custom built one at a time to exacting specifications by master craftsmen. Unlike some of our competitors who build "factory custom" or "semi-custom" firearms, there are no production lines here at Wilson Combat®/ScattergunTechnologies™; we build nothing but "custom" handcrafted firearms. But what IS a "custom" firearm? What makes it better than a quality production firearm?

To answer these questions, here's how WE build "custom" handcrafted firearms at Wilson Combat® / ScattergunTechnologies™.

We start by using skilled craftsmen who are gun people. From Bill Wilson, company owner, and the other artisans that design the quality components and decide on the specifications for the various models we build (with input from experts such as Rob Haught and members of the Law Enforcement and Military special operations community), to our experienced test fire technicians, Wilson Combat® / ScattergunTechnologies™ is fortunate to have some of the finest and most knowledgeable craftsmen in the firearms field in its employment. Our master craftsmen have as much as 23 years' experience building quality custom firearms!

But even the most talented and knowledgeable craftsman can't build a quality product without top-quality components. All Wilson Combat® / ScattergunTechnologies™ custom firearms begin life as the finest quality precision manufactured components. No expense is spared in producing the best parts possible to build our custom firearms or to sell as components to our valued customers. All of our components are 100% inspected and thoroughly field tested by knowledgeable and experienced shooters before being used to build Wilson Combat® / ScattergunTechnologies™ custom firearms. As a further testament to the quality of Wilson Combat® / ScattergunTechnologies™ components, they are "sole sourced" and used by the US Border Patrol, FBI SWAT, US Military Special Operations community and numerous specialized law enforcement units across the country.

So how do these talented craftsmen turn a box of top-quality components into a fine custom firearm worthy of being marked Wilson Combat® or ScattergunTechnologies™? Probably the most important thing we do is train "specialists." By this, we mean craftsmen who specialize in specific operations and do them to perfection. While the majority of our craftsmen are well-rounded and can do most operations required in creating a fine custom firearm, they are masters of their own specialties.



| PROCESS |

For example: Jim Wilson, who has been with us for over 23 years, is a master at fitting a 1911 slide to frame tight, but not so tight that it might affect reliable function. Our 1911 barrels are fit the same way; tight enough that we can guarantee superb accuracy, yet with just enough clearance for totally reliable functioning. In other words, their years of valuable experience allow them to fit a pistol up “just right”! The same holds true for the craftsmen who create our combat-ready tactical rifles and shotguns.

Each custom firearm moves from bench to bench as each master craftsman does his own specialized “magic”. A custom gun is always built to the customer’s specifications. First, a slide is selected and tested to insure it is just right for the handgun frame. Once the material selection is complete, the slide is fitted to the frame with care and hand lapped to insure that each custom pistol is as perfect as it can possibly become. The barrel fit is critical in a 1911 because it has the greatest effect on both reliability and accuracy. The barrel fit in a ‘true custom firearm’ has been performed by a Master Gunsmith and will lock up into the slide just right. Only then can you expect optimized performance from your custom firearm. Once the custom gun is built to the customer’s specifications, it is then surface prepped by a master craftsman as well, to ensure the flawless cosmetics Wilson guns have become famous for in the gun industry. It then goes through our own in-house finishing operation for a custom Armor-Tuff® corrosion resistant polymer finish. Each component is carefully finished one at a time to ensure a quality final product.

Next comes final assembly, where all these custom fit and finished quality components are finally put together as a completed firearm. As with all operations, a specialized craftsman does this as well. This is just the first of several quality control checks. All Wilson Combat® / ScattergunTechnologies™ custom firearms are inspected independently by technicians who are knowledgeable and experienced shooters. Once the firearm is fully assembled and the initial QC checks are made, it moves to test fire where it is zeroed and accuracy checked and not just function fired as many gun makers do. The test fire process at Wilson Combat® is extensive to say the least. Our custom firearms are not just function fired in a machine like at an assembly line gun manufacturer. Our firearms are each test fired one at a time by an experienced test fire technician. Further, no less than three types of ammunition totaling at least 80 rounds are fired through each handgun to insure that it is extremely reliable, which is the first thing a firearm must be. With all of our handguns, the customer always receives a test fire target to demonstrate their pistols accuracy potential.

After the thorough test fire process, the custom firearm is sent to final inspection. Here a craftsman with an eye for extreme quality gives the firearm a final “once-over.” Only after all this does a firearm earn the right to be called “Custom” and wear the Wilson Combat® / ScattergunTechnologies™ name!



| PROCESS |

"I have been shooting and carrying Wilson Combat® pistols since the early 1980s and they have never let me down. Through the years the consistent high quality, precise fitting, accuracy and reliability has always impressed me. I consider them to be of the highest quality and utterly reliable."

Bill Rogers is a former FBI agent, inventor and designer of police holster gear, military gear and target systems. He patented the first "Kydex" holster in 1973 and developed the most famous police security holster known as the Rogers SS 3 or Safariland 070 holster. He has been involved in the shooting industry for over 30 years and is the holder of numerous patents related to that industry. He was one of the original organizers and officers of the United States Practical Shooting Association and was a top competitor during the 1980s. He has owned and continuously operated the Rogers Shooting School (www.rogers-shooting-school.com) since 1975. He developed the concept of "reactive shooting" (engaging quickly disappearing steel targets in reaction time) and has continued to refine techniques to teach shooting and actively teach those skills. He has worked with every US specialized military and federal law enforcement unit over his 30 year career as a shooting instructor, as well as with many foreign allied units.

Bill Rogers
Former FBI agent
Master Firearms Trainer
Rogers Shooting School



"I carry a .45 every day. It is a Wilson. My daughter left home this year to go to college and I gave her my Wilson CQB Compact to keep her safe. That is proof of my trust in Bill Wilson's guns. Wilson makes reliable guns and they are a good company to deal with. You can call them and speak with real people who are extremely knowledgeable, professional and friendly. That is important when you are selecting something as personal as a defensive firearm.

The (Wilson Combat®) SDS is absolutely flawless. It is at the top of the list of all the handguns I have ever tested when it comes to quality and perfection. You have all the engineering cleverness of turn of the century genius, John Moses Browning, backed up with space age material science, computer controlled machining, and Bill Wilson's exacting demand for absolute quality. This gun is a mixture of savagery and sheer elegance that you don't see very often.

This isn't just the best concealable 1911 I've ever fired. This is the best 1911 I've ever fired, period. This is the 1911 that John Moses Browning himself would be carrying today."

Jeff Hoffman
President, Black Hills Ammunition
Law Enforcement Officer



".45 Auto continues to be one of the best sellers in the COR-BON product line. As part of production and quality control, we test every 5000 rounds for accuracy, velocity and function. We do this in REAL guns, not just test barrels. Our 1911's made by Wilson Combat® test fire thousand of rounds a week. They take this abuse daily and we have never had one go out of service. Also, as a member of the Sturgis Police Special Ops Team, I chose a Wilson CQB as my duty gun. The reliability of these guns are so profound, I know I can trust my life to it."

Peter Pi Sr
President
Cor-Bon/Glaser
Law Enforcement Officer
Sturgis, SD



"Over the last twenty-five years, I have carried many different types of 1911-style pistols. Wilson pistols are the best. I carry full sized Wilson pistols both on and off duty with full confidence every day and all of our department 1911-style pistols have been enhanced by Wilson accessories.

Most of the officers in our area and a lot of citizens bring their 1911-style pistols to me for reliability work. The first thing I do if they are serious about reliability is have them order a half dozen Wilson magazines. I couldn't be more pleased with the service we get from our customer representative. He supplies us in an expedient manner with everything we need.

Last April we arrested a convicted escaped bank robber who had shot at police in another jurisdiction. I felt amazing confidence while pointing my Wilson Protector at him and ordering him to comply. (Which he did.)

Living and working two blocks from the Pacific Ocean, even stainless duty pistols rust. Not so with Armor-Tuff. It is rustproof in this salt-water environment. My Wilson .22 rimfire is set up the same as my duty pistols, allowing me to teach and practice sights and trigger without the distraction of recoil.

Wilson pistols epitomize the needed shootability in a defensive pistol. The essential elements of safety, reliability and marksmanship are exemplified in Wilson pistols. John Moses Browning discovered the perfect pistol and Wilson perfected it."

Ernie Hanson
Retired police officer
Custom holster maker
Police and civilian firearms instructor



"I have used Wilson Combat® products virtually my whole shooting career. In both competitive shooting and work related use I have always had the highest confidence in carrying Wilson Combat® products. My original CQB pistol has more rounds through it than I could begin to count and it is still my favorite 1911. As a firearms trainer who is best known for my shotgun programs I have found the ScattergunTechnologies™ line to be ideally suited for use as either a defensive firearm or a duty use tool. A Professional Model rides to work with me every day. With WC's entry into the AR-15 market shooters now have a one stop place to cover all the bases for their shooting needs."

Rob Haught
Veteran Law Enforcement Officer
Firearms Trainer for civilian, law enforcement and military
IDPA National Champion



Wilson Combat® CQB:

"As a military advisor and special weapons instructor, every time I shoot in front of a class, my credibility is on the line. No matter how much confidence I have in my own ability, my weapon system must work flawlessly and the rounds must impact the target with impressive results. For the law enforcement professional or SPECOPS operator out on the sharp end, that accuracy and reliability is even more critical. So for anyone who carries a gun for a living or keeps one for personal protection, those two factors – "accuracy & reliability" – are paramount. But not all gun builders appreciate that fact.

Fortunately Bill Wilson understands these critical factors so it's with no surprise that Wilson Combat® is at the top of a short list of those who I will trust to build a gun for me. It is also no surprise that Wilson 45s are found in the hands and holsters of special operations personnel from all branches of the military.

I have been carrying, shooting and teaching with .45 Government Models for over two decades and have had the privilege of shooting with Bill Wilson at the national level in the early eighties. I have seen his company and product line grow to what it is today. A company built not on slick salesmanship but on Bill's personal integrity and a reputation for the highest quality and reliability.

To say that I am a satisfied customer is an understatement. The fact that I can carry any gun I chose and continue to carry and shoot a Wilson Combat® CQB .45 complete with Wilson magazines is testament enough. "

"Making every shot count!"

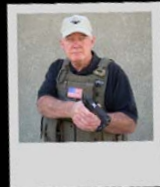

Mark Lonsdale
Director of Training & Studies
Specialized Tactical Training Unit

"As shooters we are privileged to have access to superb firearms shooters could only dream about in the pre-World War II era. One of those gunsmiths/gunmakers is Bill Wilson and his Wilson Combat® catalog is filled with the stuff dreams are made of; or for those who deem it incorrect to end a sentence with a preposition, of which dreams are made.

Obviously the background in the intricacies of watchmaking and the skill required added to the dream of building the best possible 1911s all came together to make Wilson Combat® which opened in 1978. Wilson believes in building a gun that is 100% reliable out of the box and also in 100% customer satisfaction. Wilson started as a gunsmith, graduated to custom gunmaking, and then components. Bill says: "Building custom guns is what brought us to the dance, but selling components is what really made the company grow, however now things have come back full circle and complete custom guns are where it's at."

It is fairly easy to build a 1911 with very tight tolerances and virtually no slide to frame movement; it is also quite easy to build a 1911 which is totally reliable. It is not so easy to build a gun with both of these attributes which is exactly what Wilson Combat® manages to do.

The Wilson Combat® Carry Comp is one of those amazingly tight, no play whatsoever between slide and receiver .45s while at the same time being 100% reliable out of the box. Eleven different loads, 10 of which were jacketed hollow points, weighing from 165 to 230 grains, both standard and +P versions, were tried and no matter what was placed in the magazine on the Carry Comp it fed and fired every load flawlessly.

Somewhere around the house we have a book titled 1,001 Ways To Prepare Hamburger. I really don't know why we have it since Diamond Dot couldn't follow a recipe if she had to; fortunately she has no need to as she is a natural born cook. Twice in our nearly half century together she has had to toss the evening meal; both times she followed recipes exactly. Bill Wilson is much like Diamond Dot, but with 1911s not hamburger. He doesn't need to read the book 1,001 Ways To Build 1911s; he is writing it. For nearly three decades Bill has been on the cutting-edge of custom building 1911s. If there's anything about them he doesn't know, it's not worth knowing.

From the very first round the Sentinel® could have been pressed into immediate duty. It was dead on for elevation, and with my eyes and hold shot one inch to the left; the latter is easily corrected by loosening one screw and tapping the rear sight to the right. At no time did I experience a round striking away from the point of aim, never had a failure to feed, and never had a failure to eject. This little pistol can be counted on to put a bullet exactly where desired in self-defense situation.

Wilson pistols are expensive as are all other custom sixguns and semi-automatics from a long line of top quality gunsmiths and a handful of custom quality manufacturers. How much should one spend on a defensive pistol? It was John Linebaugh who answered this question years ago when someone asked him about buying a self-defense firearm for his wife. "How much should I spend?" was the question; "How much is her life worth?" was the answer. That reply still stands. A local jewelry store pushes their products on the theme of how much do you love your wife. Diamonds may last forever; a quality pistol can guarantee a long life for the diamond wearer. "

John Taffin
Firearms Expert & Staff Writer
AMERICAN HANDGUNNER and GUNS Magazine.



Full-Size Stainless Steel Frame

30 LPI High Cut Checkered Frontstrap

High-Ride Beavertail Grip Safety

Ambidextrous Thumb Safety

3 1/2# - 3 3/4# Crisp Trigger Pull

Speed-Chute® Magazine Well

Cocobolo Double Diamond Grips

5" Carbon Steel Slide with Polished Blued Finish

Lo-Mount Adjustable Rear Sight w/Improved Ramp Front

5" Match Grade Barrel & Bushing, Handfit

Full Length Guide Rod

30 LPI Slide Top Serrations

40 LPI Checkered Rear of Slide/Extractor

Accuracy Guarantee
1 Inch @ 25 Yards

California Model Available



Specifications	
Caliber45 ACP, 9 mm or 38 Super
Magazine Capacity	8 rd.
Barrel Length	5"
Overall Length	8.7"
Sight Radius	6.9"
Height	5.6"
Width	1.5"
Weight Empty	41.4 oz.
Weight Loaded	47.7 oz.

CLASSIC SUPERGRADE

No restrictions are placed on the time, effort and expertise expended in the creation of our ultimate pistol - the Classic Supergrade. Only our most experienced veteran pistolsmiths apply their skilled trade to build a Supergrade and this select group brings over 50 years of pistolsmithing experience to the Supergrade workbench. Fewer than 20 Supergrades are hand built each month, making the Supergrade an instant collector's piece. The Supergrade is the 1911 which all others - from any source - are compared. Simply the BEST of the BEST!

More Info And Additional Products



www.wilsoncombat.com
800-955-4856

Full-Size Carbon Steel Frame

30 LPI High Cut Checkered Frontstrap

High-Ride Beavertail Grip Safety

Ambidextrous Thumb Safety

3 1/2# - 3 3/4# Crisp Trigger Pull

Speed-Chute® Magazine Well

G10 Double Diamond Grips

5" Carbon Steel Slide

Tactical Combat Pyramid® Rear Sight w/Tritium

5" Match Grade Barrel & Bushing, Handfit

Full Length Guide Rod

30 LPI Slide Top Serrations

40 LPI Checkered Rear of Slide/Extractor

Accuracy Guarantee
1 Inch @ 25 Yards

California Model Available



Specifications

Caliber45 ACP, 9 mm or 38 Super
Magazine Capacity	8 rd.
Barrel Length	5"
Overall Length	8.7"
Sight Radius	6.7"
Height	5.6"
Width	1.3"
Weight Empty	41.4 oz.
Weight Loaded	47.7 oz.

TACTICAL SUPERGRADE

More Info And Additional Products



www.wilsoncombat.com
800-955-4856

It is possible to combine breath-taking aesthetics and absolute function in a single pistol; and that is exactly what we have done in our finest defensive pistol – the Tactical Supergrade. Hand crafted from carbon steel, the Tactical Supergrade is optimized for use as the ultimate defensive handgun – which happens to have the beauty and workmanship that have made the Wilson Combat® Supergrades the standard to which all other custom pistols are compared. The Tactical Supergrade redefines the term “state-of-the-art” in every way possible. The Tactical Supergrade is simply the finest full-size defensive pistol in today’s market. If you’re the discerning individual who requires only the finest in quality materials, design, and craftsmanship, this is the pistol for you.

Compact Carbon Steel Frame

30 LPI High Cut Checkered Frontstrap

High-Ride Beavertail Grip Safety

Ambidextrous Thumb Safety

3 1/2# - 3 3/4# Crisp Trigger Pull

Speed-Chute® Magazine Well

G10 Double Diamond Grips

4" Carbon Steel Slide

Tactical Combat Pyramid® Rear Sight w/Tritium

4" Match Grade Bull Barrel, Handfit

Full Length Guide Rod w/Reverse Plug

30 LPI Slide Top Serrations

40 LPI Checkered Rear of Slide/Extractor

Accuracy Guarantee
1 Inch @ 25 Yards



Specifications

Caliber45 ACP, 9 mm or 38 Super
Magazine Capacity	7 rd.
Barrel Length	4"
Overall Length	7.6"
Sight Radius	5.6"
Height	5.1"
Width	1.3"
Weight Empty	38 oz.
Weight Loaded	43.6 oz.

TACTICAL SUPERGRADE COMPACT

Discriminating individuals the world over asked for a compact version of our Supergrade pistols. The Tactical Supergrade Compact was our answer. Peerless aesthetics and absolute function are hallmarks of the Supergrade Family, and the Tactical Supergrade Compact continues that tradition in a pistol optimized for daily carry. Hand crafted from carbon steel, the Tactical Supergrade Compact, with a 4" barrel and a slide 1" shorter than a full size, is fitted to a frame with a 1/2" shorter grip. Optimized for use as the ultimate carry pistol, with no compromises in the beauty and workmanship we're famous for. Wilson Combat® Supergrades are the standard to which all other custom pistols are compared. The Tactical Supergrade is without equal when considering a compact size defensive pistol and one you will be proud to own and carry.

More Info And Additional Products



www.wilsoncombat.com
800-955-4856

Fullsize Carbon Steel Frame

30 LPI High Cut Checkered Frontstrap

High-Ride Beavertail Grip Safety

Tactical Thumb Safety

3 1/2# - 3 3/4# Crisp Trigger Pull

Contoured Magazine Well

Fully Checkered G10 Grips

5" Carbon Steel Slide

Tactical Combat Pyramid® Rear Sight w/Tritium

5" Match Grade Barrel & Bushing, Handfit

Accuracy Guarantee
1 Inch @ 25 Yards

Available w/Light Rail Frame

Available w/Lightweight Frame
(7 oz. Lighter)

California Models Available



Specifications

Caliber45 ACP, 9 mm or 38 Super
Magazine Capacity	8 rd.
Barrel Length	5"
Overall Length	8.7"
Sight Radius	6.7"
Height	5.4"
Width	1.3"
Weight Empty	40.3 oz.
Weight Loaded	46.6 oz.

CQB

The CQB Full Size Pistol is the standard-bearer for our CQB family of pistols, and remains our most popular model. A thoroughly modernized version of the original 1911 design by John M. Browning, it is built in the original style but delivers the quality, reliability, and accuracy modern shooters demand – and is backed by our unmatched promise of performance and customer satisfaction. Whether your anticipated use is for defense, competition, or daily carry, why not experience the confidence that you will have with a Wilson Combat® CQB On Your Side®?

More Info And Additional Products



www.wilsoncombat.com
800-955-4856

Fullsize Carbon Steel Frame

30 LPI High Cut Checkered Frontstrap

High-Ride Beavertail Grip Safety

Tactical Thumb Safety

3 1/2# - 3 3/4# Crisp Trigger Pull

Speed-Chute® Magazine Well w/Lanyard Loop

G10 Diagonal, Flat Bottom Grips

5" Carbon Steel Slide

Tactical Combat Pyramid® Rear "U" Notch Sight w/Tritium

5" Match Grade Barrel & Bushing, Handfit

30 LPI Slide Top Serrations

40 LPI Serrated Rear of Slide/Extractor

Accuracy Guarantee 1 Inch @ 25 Yards

Specifications

Caliber45 ACP, 9 mm or 38 Super
Magazine Capacity	8 rd.
Barrel Length	5"
Overall Length	8.7"
Sight Radius	6.7"
Height	5.6"
Width	1.3"
Weight Empty	39.7 oz.
Weight Loaded	46 oz.



CQB ELITE

More Info And Additional Products



www.wilsoncombat.com
800-955-4856

The Close Quarters Battle Elite blows the competition away with a standard package of custom features designed to meet the needs of tactical shooting professionals, each selected with the input of experts in the field – here’s what is standard: Bullet Proof® parts throughout; serrations on the top and the rear of the slide; a U-notch pyramid rear sight with back-side serrations and subdued yellow tritium inserts; matching serrations on the back of the extractor; front sight with bright green tritium insert; checkered mainspring housing and front strap for a sure grip and standard G-10 grips with a tapered cut-out for easy access to the semi-extended magazine release button. If your requirements are for a combat pistol, a must-work-every-time firearm, custom-built to your specifications, put a Wilson Combat® CQB Elite On Your Side® today.

Compact Carbon Steel Frame

30 LPI High Cut Checkered Frontstrap

High-Ride Beavertail Grip Safety

Tactical Thumb Safety

3 1/2# - 3 3/4# Crisp Trigger Pull

Contoured Magazine Well

Fully Checkered G10 Grips

4" Carbon Steel Slide

Tactical Combat Pyramid® Rear Sight w/Tritium

4" Match Grade Bull Barrel, Handfit

Accuracy Guarantee
1.5 Inch @ 25 Yards

Available w/Lightweight Frame
(7 oz. Lighter)

California Model Available

Shown w/Optional Speed-Chute® Magazine Well



Specifications

Caliber45 ACP, 9 mm or 38 Super
Magazine Capacity	7 rd.
Barrel Length	4"
Overall Length	7.6"
Sight Radius	5.6"
Height	4.9"
Width	1.3"
Weight Empty	38 oz.
Weight Loaded	43.6 oz.

CQB COMPACT

More Info And Additional Products



www.wilsoncombat.com
800-955-4856

The CQB Compact Pistol has all the features of a full size CQB, but is reduced in size for carry purposes or for anyone who needs a smaller pistol. The slide on the CQB Compact is an inch shorter than a standard CQB and the grips are 1/2" shorter, yielding an ideal carry-size pistol - easier to conceal with less weight than a full size CQB. Like all Wilson Combat® firearms, we custom build the CQB Compact to meet your exact specifications - every part is hand-fit for reliability, performance, and accuracy. Whether your anticipated use is for home defense or daily carry, why not experience the confidence that you will have with a Wilson Combat® CQB Compact On Your Side®?

Fullsize Carbon Steel Frame

30 LPI High Cut Checkered Frontstrap

High-Ride Beavertail Grip Safety

Tactical Thumb Safety

3 1/2# - 3 3/4# Crisp Trigger Pull

Speed-Chute® Magazine Well

Contoured Magazine Well

G10 Diagonal, Flat Bottom Grips

Integral Light Rail

5" Carbon Steel Slide

Tactical Combat Pyramid® Rear "U" Notch Sight w/Tritium

5" Match Grade Bull Barrel, Handfit

Accuracy Guarantee
1 Inch @ 25 Yards

Shown w/Optional Sure-Fire® Weapon Light

Specifications

Caliber45 ACP, 9 mm or 38 Super
Magazine Capacity	8 rd.
Barrel Length	5"
Overall Length	8.7"
Sight Radius	6.7"
Height	5.6"
Width	1.3"
Weight Empty	41.0 oz.
Weight Loaded	49.1 oz.



TACTICAL LE

Tactical shooting professionals the world over favor Wilson Combat®'s Close Quarter Battle pistol – our CQB. The CQB Tactical LE is a specialized version of the CQB especially for the unique requirements of SWAT entry teams, military Special Operations, and other law enforcement specialists. This powerhouse includes as standard an integral light-mount frame and our bushing-less heavy cone barrel. Coupled with our Speed-Chute® magazine well, quick and positive no-look reloading is assured in the most intense situations. If tactical shooting missions might be in your profile, the Wilson Combat® CQB Tactical LE On Your Side® offers the utmost in reliability and functional design.

More Info And Additional Products



www.wilsoncombat.com
800-955-4856

Fullsize Carbon Steel Frame

30 LPI High Cut Checkered Frontstrap

High-Ride Beavertail Grip Safety

Tactical Thumb Safety

3 1/2# - 3 3/4# Crisp Trigger Pull

Contoured Magazine Well

Fully Checkered G10 Grips

4" Carbon Steel Slide

Tactical Combat Pyramid® Rear Sight w/Tritium

4" Match Grade Bull Barrel, Handfit

Accuracy Guarantee
1.5 Inch @ 25 Yards

Shown w/Optional Speed-Chute® Magazine Well

Available w/Lightweight Frame
(7 oz. Lighter)

California Model Available



Specifications	
Caliber	45 ACP, 9 mm or 38 Super
Magazine Capacity	8 rd.
Barrel Length	4"
Overall Length	7.6"
Sight Radius	5.6"
Height	5.4"
Width	1.5"
Weight Empty	38.1 oz.
Weight Loaded	44.4 oz.

PROFESSIONAL

We take pride in innovation at Wilson Combat®, which often includes listening to our customers and building what they ask for. The Wilson Combat® Professional model pistol is a direct result of consumer requests, and has been a customer favorite since its introduction – a custom handgun with a full-size frame mated to a compact barrel/slide assembly. If you shoot a full-size 1911 pistol, this built-for-carry gun is going to feel great in your hands – the frame is the size you have become accustomed to holding. And after experiencing the ease and speed of getting on target with the compact slide and shorter sight radius, you will agree – this is a fine firearm to have On Your Side®.

More Info And Additional Products



www.wilsoncombat.com
800-955-4856

Fullsize Carbon Steel Frame

30 LPI High Cut Checkered Frontstrap

High-Ride Beavertail Grip Safety

Tactical Thumb Safety

3 1/2# - 3 3/4# Crisp Trigger Pull

Contoured Magazine Well

Cocobolo Double Diamond Grips

5" Carbon or Stainless Steel Slide

Lo-Mount Adjustable Rear Sight w/Improved Ramp Front

5" Match Grade Barrel & Bushing, Handfit

Accuracy Guarantee
1 Inch @ 25 Yards

California Model Available

Shown w/Two-Tone Upgrade and Optional Speed-Chute® Magazine Well

Specifications

Caliber45 ACP, 9 mm or 38 Super
Magazine Capacity	8 rd.
Barrel Length	5"
Overall Length	8.7"
Sight Radius	6.9"
Height	5.4"
Width	1.3"
Weight Empty	41.2 oz.
Weight Loaded	47.5 oz.



CLASSIC

The Wilson Combat® Classic features the timeless look and function of a traditional full house 1911 pistol, considered by many to be the optimum marriage of a full featured match and carry pistol. Over the years, one of the most popular improvements to a 1911 pistol has been improving the sights. Typically that has meant incorporating an adjustable sight on the rear. We use our own Wilson Lo-Mount Adjustable Rear Sight – many people consider it the best in the world. If you have ever encountered broken adjustable rear sights, try this one and you will understand why it is so popular. If you ever shoot in low light situations, we can add tritium inserts. If you love the traditional full size 1911 pistol, the Wilson Combat® Classic will greatly exceed your expectations. Regardless if it is for home defense, personal carry, or competition, this firearm will meet your needs.

More Info And Additional Products



www.wilsoncombat.com
800-955-4856

Fullsize Carbon Steel Frame

30 LPI High Cut Checkered Frontstrap

High-Ride Beavertail Grip Safety

Tactical Thumb Safety

3 1/2# - 3 3/4# Crisp Trigger Pull

Contoured Magazine Well

Fully Checkered G10 Grips

5" Carbon or Stainless Steel Slide

Tactical Combat Pyramid® Rear Sight w/Tritium

5" Match Grade Barrel & Bushing, Handfit

Full Length Guide Rod w/ Plug

Accuracy Guarantee
1 Inch @ 25 Yards

California Model Available

Shown w/Two-Tone Upgrade and Optional Speed-Chute® Magazine Well



Specifications

Caliber45 ACP, 9 mm or 38 Super
Magazine Capacity	8 rd.
Barrel Length	5"
Overall Length	8.7"
Sight Radius	6.7"
Height	5.4"
Width	1.3"
Weight Empty	41.2 oz.
Weight Loaded	47.5 oz.

PROTECTOR®

Sometimes crafted from stainless steel, often two-tone with the slide finished in black Armor-Tuff® over a stainless steel finished frame, the Protector® has proven to be a popular executive's choice. With excellent cosmetic appeal to catch anyone's eye, it also offers special features that result in a near-perfect defensive weapon. The Protector® is a superb blend of form and function. The Protector® has a hand-fit match-grade barrel with bushing and a full-length guide rod offering unparalleled performance round after round.

More Info And Additional Products



www.wilsoncombat.com
800-955-4856

Full-Size Carbon Steel Frame

30 LPI High Cut Checkered Frontstrap

High-Ride Beavertail Grip Safety

Ambidextrous Thumb Safety

3 1/2# - 3 3/4# Crisp Trigger Pull

Speed-Chute® Magazine Well

Starburst G10 Grips

5" Carbon Steel Slide

Tactical Combat Pyramid® Rear Sight w/Tritium

5" Match Grade, Heavy Flanged Cone Barrel, Handfit

Full Length Guide Rod w/Reverse Plug

Accuracy Guarantee
1 Inch @ 25 Yards

Available w/Lightweight Frame
(7 oz. Lighter)

California Model Available



Specifications

Caliber45 ACP, 9 mm or 38 Super
Magazine Capacity	8 rd.
Barrel Length	5"
Overall Length	8.7"
Sight Radius	6.7"
Height	5.6"
Width	1.3"
Weight Empty	41.6 oz.
Weight Loaded	48.2 oz.

TACTICAL ELITE

More Info And Additional Products



www.wilsoncombat.com
800-955-4856

We all want to avoid life and death encounters – but if you are unfortunate enough to find yourself in one – you don't want to have to worry about the performance of your firearm. With all the combat proven features of a typical CQB, the Tactical Elite provides the additional advantage of a fully supported hand-fit, heavy flanged cone match grade barrel. The extra weight of the heavier-than-standard barrel gives the shooter softer recoil and faster recovery time between shots. Possibly the easiest .45ACP pistol to shoot well in today's market, it is the highest performance self defense pistol available. When nothing less than 100% functional reliability, fast handling, rapid shot-to-shot recovery and accuracy is demanded, you want to have a Wilson Combat® Tactical Elite On Your Side®.

- Compact Carbon Steel Frame
- 30 LPI High Cut Checkered Frontstrap
- High-Ride Beavertail Grip Safety
- Tactical Thumb Safety
- 3 1/2# - 3 3/4# Crisp Trigger Pull
- Contoured Magazine Well
- Double Diamond Cocobolo Grips
- 4" Carbon Steel Slide
- Tactical Combat Pyramid® Rear Sight w/Tritium
- 4" Match Grade, Heavy Flanged Cone Barrel, Handfit
- Full Length Guide Rod w/Reverse Plug
- Accuracy Guarantee
1.5 Inch @ 25 Yards
- Available w/Lightweight Frame
(7 oz. Lighter)
- California Model Available



Specifications	
Caliber45 ACP, 9 mm or 38 Super
Magazine Capacity	7 rd.
Barrel Length	4.1"
Overall Length	7.7"
Sight Radius	5.6"
Height	4.9"
Width	1.3"
Weight Empty	37.1 oz.
Weight Loaded	42.7 oz.

STEALTH (S.D.S.)

Executives, professionals in all walks of life, and others who carry daily asked for Wilson Combat®'s legendary reliability, fit, and finish in a package even smaller than our Professional series – with the excellent recovery characteristics and accuracy offered by our innovative heavy cone barrel. The SDS is the answer we provided. It includes the best of several of our models, enhanced with a 4 1/16" version of the hand-fit, heavy flanged cone match grade barrel pioneered on our Tactical Elite, and a frame shortened by 1/2" with 7 round capacity. The slide length is reduced by a full inch from a standard length 1911, giving you a speed advantage in target acquisition with the shorter sighting plane. The shorter frame SDS with the accompanying short slide gives you the maximum concealability available with outstanding accuracy and successive shot recovery. Many shooters find the SDS's near perfect balance and controllability exceeds many pistols with 5" barrels.

More Info And Additional Products



www.wilsoncombat.com
800-955-4856

- Full-Size Carbon Steel Frame
- 30 LPI High Cut Checkered Frontstrap
- High-Ride Beavertail Grip Safety
- Ambidextrous Thumb Safety
- 3 1/2# - 3 3/4# Crisp Trigger Pull
- Speed-Chute® Magazine Well
- Double Diamond Cocobolo Grips
- 4" Carbon Steel Slide
- Tactical Combat Pyramid® Rear Sight w/Tritium
- 4" Match Grade, Heavy Flanged Cone Barrel, Handfit
- Full Length Guide Rod w/Reverse Plug
- Accuracy Guarantee
1.5 Inch @ 25 Yards
- Available w/Lightweight Frame
(7 oz. Lighter)
- California Model Available
- Shown w/Optional Ed Brown Products® Bobtail®



Specifications	
Caliber45 ACP, 9 mm or 38 Super
Magazine Capacity	8 rd.
Barrel Length	4.1"
Overall Length	7.7"
Sight Radius	5.6"
Height	5.6"
Width	1.3"
Weight Empty	39.5 oz.
Weight Loaded	45.8 oz.

ELITE PROFESSIONAL

Wilson Combat®'s Professional series of pistols are some of the most popular we build. The Elite Professional is the newest member of that series. It includes the best of several of our models, enhanced with a 4 1/16" version of the hand-fit, heavy flanged cone match grade barrel pioneered on our Tactical Elite. With this barrel, we have reduced the slide length by a full inch, giving you a speed advantage in target acquisition with the shorter sighting plane. The frame is the comfortable full size you're accustomed to in your traditional 1911 pistol, but with the shorter slide the result is excellent concealability. An excellent choice for daily carry, The Elite Professional provides the rapid shot-to-shot recovery and reduced recoil one would expect from a compensated pistol. You can be sure of 100% functional reliability, fast handling, rapid shot-to-shot recovery and accuracy when you need it.

More Info And Additional Products



www.wilsoncombat.com
800-955-4856

Sentinel® Carbon Steel Frame
-1/2" Shorter Than a Compact

30 LPI High Cut Checkered
Frontstrap

High-Ride Beavertail Grip
Safety

Tactical Thumb Safety

3 1/2# - 3 3/4# Crisp Trigger
Pull

Contoured Magazine Well

Micarta® Slimline Grips

3 1/2" Carbon Steel Slide

Tactical Combat Pyramid®
Rear Sight w/Tritium

3 1/2" Match Grade Bull Barrel,
Handfit

Full Length Guide Rod w/Re-
verse Plug

Carry Cuts

Accuracy Guarantee
1.5 Inch @ 25 Yards

Also Available w/Compact or
Professional Frame

All Available w/Lightweight
Frame (7 oz. Lighter)

Specifications

Caliber	9 mm
Magazine Capacity	8 rd.
Barrel Length	3.6"
Overall Length	7.2"
Sight Radius	5.3"
Height	4.4"
Width	1.3"
Weight Empty	34.3 oz.
Weight Loaded	37.6 oz.



SENTINEL®

One of the things you can be absolutely sure of with a Wilson Combat® firearm is reliability. Our Sentinel® model was developed to provide maximum concealability with our reliability promise. The result is a precisely engineered 9mm with a scant 7.25" overall length and weighing only 32 ounces fully loaded and ready to work. We developed a 3.6", bull barrel for the Sentinel®, with a tapered cone shape to concentrate as much weight as possible towards the muzzle, and coupled with a full-length guide rod. The Sentinel® incorporates cocking serrations on the rear of the slide, and carry cuts at the front of the slide.

More Info And Additional Products



www.wilsoncombat.com
800-955-4856

Compact Carbon Steel Frame

30 LPI High Cut Checkered Frontstrap

High-Ride Beavertail Grip Safety

Tactical Thumb Safety

3 1/2# - 3 3/4# Crisp Trigger Pull

Contoured Magazine Well

G10 Starburst Grips

Countersink Slide Stop

Round Butt

4" Carbon Steel Slide

Carry Cuts

Tactical Combat Pyramid® Rear Sight w/Tritium

4" Match Grade Bull Barrel, Handfit

Serrated Slide Top

Accuracy Guarantee 1.5 Inch @ 25 Yards



Specifications

Caliber45 ACP
Magazine Capacity	7 rd.
Barrel Length	4"
Overall Length	7.6"
Sight Radius	5.6"
Height	4.9"
Width	1.3"
Weight Empty	35.0 oz.
Weight Loaded	38.5 oz.

BILL WILSON CARRY PISTOL

We are constantly asked "So what does Bill Wilson carry?" In response to customer requests, we are proud to introduce the Bill Wilson Carry Pistol. This is an exact clone of what you will find on Bill Wilson's hip on a daily basis. The Bill Wilson Carry Pistol is based on our CQB Compact with some custom upgrades. The front of the slide has our carry cuts to narrow the muzzle. The top of the slide is serrated at 30 LPI. The frame has the round butt modification to provide a more comfortable carry and minimize printing. The slide stop post has been recessed and the hole chamfered to allow the use of Crimson Trace laser grips if so desired.

More Info And Additional Products



www.wilsoncombat.com
800-955-4856

Fullsize Carbon Steel Frame

30 LPI High Cut Checkered Frontstrap

High-Ride Beavertail Grip Safety

Tactical Thumb Safety

3 1/2# - 3 3/4# Crisp Trigger Pull

Contoured Magazine Well

Crimson Trace Laser Grips

5" Carbon Steel Slide

Lo-Mount Adjustable Rear Sight w/Improved Ramp Front

5.5" Heavy Cone Barrel w/ Supported Chamber, Or Accu-Comp w/ Supported Chamber, Handfit

Caliber - .460 Rowland

Also Available In 10mm

185gr JHP at 1425 FPS
200gr JHP at 1300 FP
230gr FMJ or JHP at 1250 FPS

Actual Muzzle Velocity From The 5.5" Barrel Wilson Combat® Hunter

Accuracy Guarantee
1 Inch @ 25 Yards



Specifications

Caliber460 Rowland, 10mm
Magazine Capacity	7 rd.
Barrel Length	5.5"
Overall Length	9.2"
Sight Radius	6.9"
Height	5.4"
Width	1.3"
Weight Empty	39.7 oz.
Weight Loaded	48.6 oz.

HUNTER

Are you a handgun hunter? Frustrated with a fat revolver that you have to cock for every shot and that won't give you rapid, accurate second shot capability? Would 2 more round capacity give you more confidence? Tired of dramatic changes in point-of-impact when changing bullet weights? If so, we have the gun for you – our new .460 Rowland Hunter – a serious hunting weapon built on the time proven 1911 platform.

More Info And Additional Products



www.wilsoncombat.com
800-955-4856

| CUSTOM UPGRADES |



AMBIDEXTROUS SAFETY



SPEED-CHUTE®



SLIDE TOP SERRATIONS



ROUND BUTT



CARRY COMP



CARRY CUTS



COUNTERSINK SLIDE STOP



CHECKERED REAR OF SLIDE



TRIGGER GUARD CHECKERING

Let Us Build Your Dream Gun

If you are seriously into competitive shooting, as I was in 1977, you tend to develop your own idea of exactly how your pistol should look, feel, shoot, etc. It wasn't surprising that many other shooters had their own ideas about the perfect gun for their use – and it wasn't the same as mine.

I started customizing my own guns, and developed some that performed, looked, and felt the way I thought they should. Before long, other people noticed what I was shooting, and wanted something similar – but not exactly like what I had. So in 1977, I started customizing their 1911 style pistols, and experienced first hand many of the different combinations of features and customizations that world-class shooters favored. Since then, I've used many of their ideas in our complete line of firearms, and recognized that there are about as many ideas of how a pistol should be built as there are people – and none of them are wrong, just different. I've built a lot of interesting pistols in the last 30 plus years.

If you're a typical shooter, you just might have an idea right now of what your dream gun would be – caliber, barrel type, size, grips, color, stainless or carbon steel or a combination, maybe even a polymer frame. We offer choices in trigger, safety, hammer, magazine capacity, internal parts - virtually every component of 1911-style pistols.

Call one of our Customer Service Representatives today, and let us quote your dream gun. And let Wilson Combat® build that dream gun exclusively for you – down to your name engraved on the slide alongside ours.

You might even want us to take a 1911 pistol you already own and take it to a higher level of performance, reliability, accuracy, and appearance. No one blends form with function better than Wilson Combat®. We can simply install a set of sights, do a crisp trigger job or fit a match grade barrel for you; or we will fully customize your pistol the way you want it.

Today is a good day to get started on your dream gun. Call one of our Customer Satisfaction Representatives and discuss YOUR dream gun and get an estimate of our current delivery schedule.

We work on customer supplied Colt*, Springfield Armory*, Kimber* or Smith & Wesson* pistols. We require a \$50.00 deposit when you send in your pistol and Custom Work Order.

Bill Wilson

* Registered trade name of other company not owned, associated or to be confused with Wilson Combat® / Scattergun Technologies™ .



| DREAM GUN |

ARMOR-TUFF® PROTECTIVE FIREARMS FINISH

ARMOR-TUFF® Protective Firearms Finish was developed specifically for firearms use to provide a surface finish with optimum corrosion protection, abrasion resistance and lubricity. It permanently bonds to the surface of the firearm to form a barrier from acids, oils, paint remover, powder solvents, bore cleaners and other strong industrial solvents. The extremely low curing temperature (300 degrees) prevents possible damage to parts during the curing process. A firearm finished with ARMOR-TUFF® has the most durable, chemical and heat resistant, thermally cured finish available.

Before a firearm is coated with ARMOR-TUFF® the firearm is thoroughly sand blasted with fine grit media, then carefully dehorned and surface prepped. Every carbon steel firearm is parkerized before we apply the finish to form a bonding surface for ARMOR-TUFF® that increases finish durability. A highly trained technician then sprays the ARMOR-TUFF® finish on the firearm before it is thermally cured. After the firearm is re-assembled, a Master Class shooter performs a 100% inspection to insure the finish meets our high standard of quality.

Appearance:

ARMOR-TUFF® has a very attractive satin/matte surface finish that looks very similar to an ultra-fine sandblast blue job. ARMOR-TUFF® is available in matte black, matte OD green and matte grey. We can also do combinations of these colors. A firearm with a black top end and grey or OD green lower looks really "outstanding".

Corrosion Resistance:

ARMOR-TUFF®, when applied to bare common gun steel, will pass the test procedures for salt water spray at 1000 hours, salt water immersion at a minimum of 1000 hours, accelerated salt spray test equivalent to 30 years marine atmosphere exposure, and 60 days sea water immersion. ARMOR-TUFF® surfaces will NEVER rust when subjected to normal firearm use.

Lubricity:

ARMOR-TUFF® contains molybdenum disulfide, which provides excellent anti-friction characteristics. We do, however, still recommend a quality lubricant (preferably synthetic) be used on contact surfaces.

Fluid Resistance:

ARMOR-TUFF® will meet 24-hour immersion requirements in the following fluids: aviation gasoline, hydraulic fluid, jet fuel, lubricating oils, paint removers, trichloroethylene, nitric, sulphuric and hydrochloric acids, hydrogen peroxide, gun powder solvents, common gun lubricants, strong bases such as hydroxide, and numerous other strong chemicals.

Thermal Stability:

ARMOR-TUFF® will withstand exposure to temperature extremes of +500 degrees F to -250 degrees F.

Thickness:

ARMOR-TUFF® has a nominal thickness of between .0003" and .0009" unless a thicker coating is desired, such as on high-wear areas like a pistol grip safety or frontstrap. The thin coating characteristics of less than one thousandth of an inch allow easy re-assembly of precision fitted parts.

Finish Quality:

ARMOR-TUFF® is applied at our finishing facility in Berryville, Arkansas, under the strictest quality control standards.

#500
Elite Tactical Magazine, .45
ACP, 8 Rd.

#500B
Elite Tactical Magazine, .45
ACP, Black, 8 Rd.

#500,9
Elite Tactical Magazine,
9 mm, 10 Rd.



ETM | ELITE TACTICAL MAGAZINES |

More Info And Additional Products



www.wilsoncombat.com
800-955-4856

The ETM started with a blank sheet of paper, 30+ years of custom building 1911s and 30+ years of building legendary 1911 magazines. The ETM is no re-design of a 7 round magazine which has been reconfigured for 8 round capacity; it's a totally NEW product designed from the ground-up as a premium 8 round tactical magazine. It WILL set a new standard in 1911 magazines while redefining state-of-the-art. We've blended the latest improvements in manufacturing and materials technology with our own real-world shooting experience to provide quality, quality, and more quality. From material selection to manufacturing process to final testing – this magazine is built like your life, and ours, depended on it, as someday it may. No compromises, just stone-cold reliability.

#47
7 Rd., Govt., Std. .350" Pad

#47CB
7 Rd., Govt., Lo-Profile Pad,
Black

#47C
7 Rd., Govt., Lo-Profile Pad

#47D
8 Rd., Govt., Std. .350" Pad

#47DE
8 Rd., Govt., Ext .625" Pad

#47DCB
8 Rd., Govt., Lo-Profile Pad,
Black

#47DC
8 Rd., Govt., Lo-Profile Pad

#47DAB
8 Rd., Govt., Aluminum .350"
Pad, Black

#47DA
8 Rd., Govt., Aluminum .350"
Pad

#47T
10 Rd., Govt., Std. Pad



SERIES 47 LEGENDARY MAGAZINES

Wilson Combat® has been supplying serious shooters and professionals with the worlds' most reliable and durable .45 auto magazines for the past 25 years. They are used by the worlds' most elite US Army SPEC OPS unit, FBI SWAT, THUNDER RANCH® and professionals worldwide. NO other .45 magazine on the market can compare for proven inherent reliability, durability and the ability to remain fully loaded for long periods of time without damage. Our magazine springs are specially fabricated from the highest tensile strength heavy duty spring wire for long service life, enhanced feeding and positive slide stop operations. Our magazine bodies are manufactured from .027" (the thickest in the industry) aircraft grade certified 17-7 PH stainless steel and heat treated for maximum durability and service life.

More Info And Additional Products



www.wilsoncombat.com
800-955-4856

#47TB
10 Rd., Govt., Lo-Profile Pad,
Black

#47,OX
7 Rd., OM., .350" Pad

#47,OXc
7 Rd., OM., Lo-Profile Pad

#47DOX
8 Rd., OM., Steel OM Pad

#47OXCB
7 Rd., OM., Lo-Profile Pad,
Black

#47DOXB
8 Rd., OM., Steel OM Pad,
Black

#47SX
9 Rd., 38 Super, Std. .350" Pad

#47NX
9 Rd., 10 mm / 40 S&W, Std.
.350" Pad

#47BLP
Steel Lo-Profile Pad

#47BEN
Aluminum .350" Pad, Black



SERIES 47 LEGENDARY MAGAZINES

"Back in 1980, Bill Wilson asked me to test some of his new Wilson-Rogers .45 magazines. He explained that he felt they had solved the problem of cracked feed lips and that their new magazines fed much more reliably than any others on the market. Well, it's 28 years later now and I'm still using some of those original 6 prototype magazines that Bill sent me...Through the years they have proven without a doubt to be the most reliable and durable 1911 magazines on the market. I have personally used specimens from various production runs through the years and have yet to see any quality variation or have one let me down in any way. They are my first and only choice as well as the choice of the elite special forces units I train. I trust my life to a Wilson Combat® pistol and 8-round Wilson magazines; so can you..."

Ken Hackathorn

Tactical Shooting Instructor, Gun Writer, IPSC & IDPA Founder

More Info And Additional Products



www.wilsoncombat.com
800-955-4856



#6BNBP / 6SNBP



#6BLLBP / 6SLLBP



#192BBP / 192SBP



#298BBP / 298SBP



#31TBP / 31TSBP



#399B,70 / 399S,70 / 399B,80



#414B / 414S / 414BS / 414SS



#415,70 / 415,80



#416,45 / 416,38



#417

BULLET PROOF® PARTS

Bullet Proof® parts are fully machined from solid bar stock with extra metal left in critical areas for added durability. But the real key to a Bullet Proof® part is the material. After considerable research and field testing, we have found what we believe to be the finest steels possible which when properly heat treated, produces a truly Bullet Proof® part.

6BNBP / 6SNBP - Tactical Thumb Safety, Bullet Proof®

6BLLBP / 6SLLBP - Low Lever Thumb Safety, Bullet Proof®

192BBP / 192SBP - Ambidextrous Thumb Safety, Bullet Proof®

298BBP / 298SBP - High-Ride Beavertail Grip Safety, Bullet Proof®

31TBP / 31TSBP - Tactical Magazine Release, Bullet Proof®

399B,70 / 399S,70 / 399B,80 - Firing Pin Stop, Bullet Proof®, #399B,80 fits Series 80
Also available in a square bottom version #399B,70SQ / #399S,70SQ

414B / 414S - Slide Stop, Bullet Proof® #414BS / #414SS fit 9mm / .38 Super

415,70 / 415,80 - Extractor, Bullet Proof®, #415,80 fits Series 80, Available in stainless steel - #415,70S / #415,80S

416,45 / 416,38 - Firing Pin, Bullet Proof®, #416,38 fits 9 mm / .38 Super

417 - Sear Spring, Bullet Proof®





#1

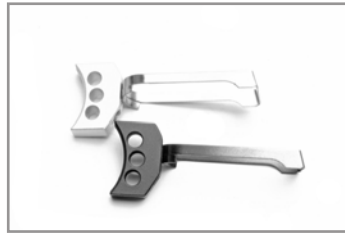

#190 / 190B

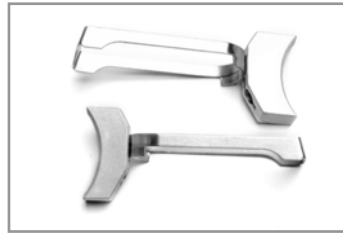

#190M / 190S

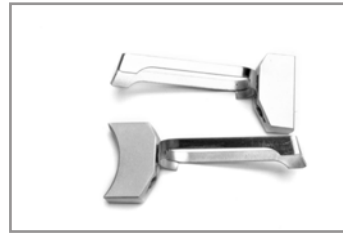

#190F / 190NH



#337B / 337S



#299B / 299S



#455B



#314 / 314C



#6B / 6S



#6BN / 6SN

FIRE CONTROL / SAFETIES

1 - Competition Match Trigger - Wilson three-hole serrated aluminum pad in a matte silver finish with overtravel adjustment screw and a blued steel bow. No fitting required.

190 / 190B - Ultralight Match Trigger - The pad is machined from aircraft grade aluminum with a serrated front and our trademark three-hole skeletonized design. The bow is hardened stainless steel which has been polished to reduce bow-to-frame friction. Features an adjustable overtravel screw for precision adjustment. Minor fitting required. #190B features a black Armor-Tuff® pad.

190M / 190S - Ultralight Match Trigger - #190M features a medium length pad, #190S features a short pad.

190F / 190NH - Ultralight Match Trigger - #190F features a flat pad, #190NH features a standard length solid pad.

337B / 337S - Skeletonized Ultralight Hammer - This hammer features a skeletonized spur for minimum weight and fastest possible lock time, hammer hooks cut to .020" with 8 RMS ground finish and narrow half-cock notch to prevent sear nose damage. Minor fitting required.

299B / 299S - Deluxe Commander Style Hammer - The rugged reliability of our deluxe commander hammer has made it extremely popular with serious shooters. These hammers are skeletonized to provide a lightning-fast lock time without sacrificing durability. The deluxe hammer features a narrow half-cock notch similar to those found on the 70 series hammers for maximum security. Minor fitting required.

455B - Value Line Speed Hammer - Our value line speed hammer is manufactured using the MIM process, which produces a quality product at a much lower price than possible with conventional manufacturing methods. For best results, we recommend using this hammer in conjunction with our #314C value line sear. Minor fitting required.

314 / 314C - Deluxe A-2 Sear / Value Line Sear - The sear is the heart of a fine trigger job and must have the proper finish and design. The deluxe A-2 sear is precision wire EDM cut from S-7 tool steel bar stock, heat-treated for maximum hardness and then the contact surfaces are ground to an ultrasmooth 8 RMS finish. The value line sear is manufactured using the MIM process which produces a quality product at a much lower price. Minor fitting required.

6B / 6S - Extended Thumb Safety, Wide - The wide extended thumb safety allows for maximum flexibility. You can custom contour the pad to meet your particular requirements or leave the wide serrated lever unaltered for maximum thumb engagement. Minor fitting required.

6BN / 6SN - Tactical Thumb Safety - Pistols that are used for concealed carry and tactical use must have a narrow profile thumb safety to keep them from being accidentally disengaged and snagging on clothing when drawn. Minor fitting required.



#192B / 192S



#423B / 423S / 423B/S-CT



#298B / 298S



#429BG / 429SG



#429BC / 429SC



#402



#7B / 7S



#102B / 102S



#102BS / 102SS



#188B / 188S

FIRE CONTROL / SAFETIES / FRAME PARTS

192B / 192S - Tactical Ambidextrous Thumb Safety - The Tactical Ambi will allow your 1911 to be operated with either the right or left hand. This is an essential feature for left-handed shooters, but has many other uses, including combat competition. Both levers are extended and serrated with the left side being slightly wider than the right. Minor fitting required.

423B / 423S / 423B/S-CT - High-Ride Ambidextrous Thumb Safety - The High-Ride Ambi provides a comfortable thumb rest for shooters who prefer to shoot with a high thumb. Both sides are extended, wide and angled downward for greatly enhanced shooter comfort, while allowing rapid action of the safety. This is also an excellent choice for lefties looking for a slightly wider lever on the right side of the gun. Minor fitting required. #423B-CT & 423S-CT fit pistols with Crimson Trace Laser Grips.

298B / 298S - High Ride Beavertail Grip Safety - The High Ride Beavertail Grip Safety will improve the comfort and controllability of your 1911 Auto. This is accomplished by allowing the shooting hand to be positioned closer to the plane of the bore while spreading the recoil over a broad rounded surface. The bottom of the High Ride Safety features our raised Posi-Release tab which assures positive grip safety disengagement while serving as a grip memory point each time you draw your pistol. The top of the High Ride Safety has a hammer pocket which makes the pistol more snag-free by allowing a commander or bobbed spur hammer to sit down in the beavertail when cocked. Frame modification required.

429BG / 429SG / 429BC / 429SC - Drop-In Beavertail Grip Safety - Now you can have a high ride beavertail grip safety on your Colt pistol without cutting the frame. This provides better control of your pistol while eliminating the discomfort and hammer bite that are possible with stock grip safeties. To return your gun to stock condition, simply re-install the factory part. The drop-in safety is designed to work with a commander style hammer or a bobbed spur hammer. (429BC & SC fit commander style 1911)

402 - Beavertail Installation Jig - Installation of a Wilson High Ride (#298) beavertail requires cutting the frame to fit the beavertail. Our beavertail fitting jig mounts to the hammer and thumb safety pin holes to serve as a filing guide to help prevent over cutting of the frame.

7B / 7S - Extended Slide Release - The use of our Extended Slide Release allows the right thumb to actuate the slide release with minimal grip change, which can save valuable time. Minor fitting required.

102B / 102S / 102BS / 102SS - Factory Plus Slide Stop - This is a precision manufactured, heat-treated slide stop, completely interchangeable with Colt or military parts without fitting. Perfect for building up a frame kit. (102BS & 102SS fit .38 Super / 9MM)

188B / 188S - Magazine Well - Our custom Magazine Well provides a large beveled opening for super fast magazine changes without adding unnecessary bulk to your pistol. These magazine wells are manufactured from solid steel to provide a durable and attractive addition to your firearm. The custom Magazine Well attaches to the grip screw bushings and is held in place by the grip panels. No frame modification is required, however slight modification to the grip panel is required unless relieved grips are used.

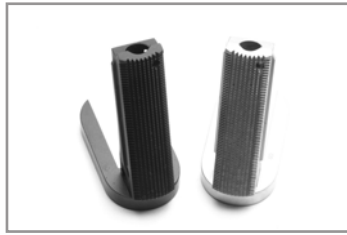

#366BF / 366SF



#366BFL / 366SFL



#366BFO / 366SFO

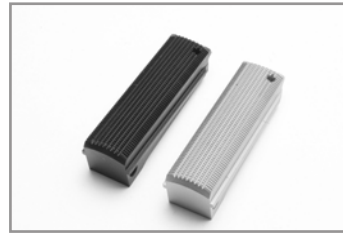

#92BF / 92SF



#92BFL / 92SFL

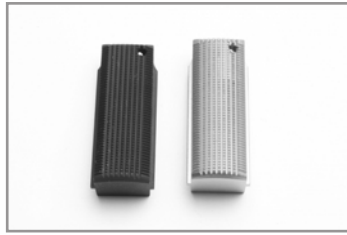

#92BFO / 92SFO

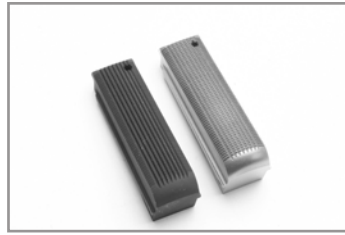

#92BV / 92SV

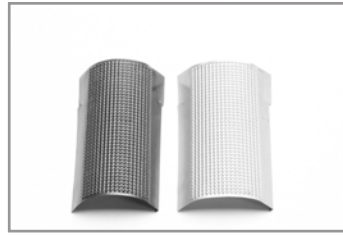

#100B / 100S



#31T / 31TS



#31B / 31S

FRAME PARTS

366BF / 366SF / 366BFL / 366SFL - Speed-Chute® - The Speed-Chute® is a two piece combination mainspring housing with cut checkering (20x30 LPI) and oversized magazine guide. Its interlocking design provides a rock solid magazine guide without the gaps and rattling sometimes associated with competitive products. If you need to remove the magazine funnel for concealed carry, simply remove the mainspring housing pin, separate the funnel from the mainspring housing, and reinstall the pin. It's that easy! The Speed-Chute® is fully machined from bar stock steel for the best quality possible. Fits all standard 1911 style frames. (366BFL & 366SFL include integral lanyard loop)

366BFO / 366SFO - Speed-Chute® - The Speed-Chute® is a two piece combination mainspring housing with cut checkering (20x30 LPI) and oversized magazine guide. Its interlocking design provides a rock solid magazine guide without the gaps and rattling sometimes associated with competitive products. If you need to remove the magazine funnel for concealed carry, simply remove the mainspring housing pin, separate the funnel from the mainspring housing, and reinstall the pin. It's that easy! The Speed-Chute® is fully machined from bar stock steel for the best quality possible. Fits compact / officers 1911 style frames.

92BF / 92SF / 92BFL / 92SFL - Mainspring Housing - The addition of our steel Checkered (20x30 LPI) Mainspring Housing is a great way to improve the grip and appearance of your 1911 Auto. You'll be amazed at the quality of this part. It's fully machined from bar stock with real cut checkering. The checkered mainspring is a great drop-in enhancement. Low luster glass bead finish. (92BFL & 92SFL include integral lanyard loop)

92BFO / 92SFO - Mainspring Housing - The addition of our steel Checkered (20x30 LPI) Mainspring Housing is a great way to improve the grip and appearance of your 1911 Auto. You'll be amazed at the quality of this part. It's fully machined from bar stock with real cut checkering. The checkered mainspring is a great drop-in enhancement. Low luster glass bead finish. Fits compact / officers 1911 style frames.

92BV / 92SV - V-Grip Mainspring Housing - The V-Grip fully machined and checkered mainspring housing is a perfect addition to a pistol with a high ride beavertail grip safety. It will force the web of your hand up high into the grip safety providing you with a consistently high grip. The higher your hand is in relation to the bore the less muzzle flip you will get during recoil.

100B / 100S - Checkered Frontstrap - Provides a non-slip surface for quick follow-up shots, even with sweaty hands. Wrap around checkered frontstraps are an inexpensive substitute for hand checkering. The frontstrap is secured in place with the pistols grip panels. This is a drop-in part requiring only a screw driver for installation.

31T / 31TS - Tactical Mag Release - If you're looking for a magazine release that extends slightly further than your factory release, but you don't want a button or paddle, try our Tactical Magazine Release which extends only 1/16 of an inch further than your factory release. This magazine release provides extra length for positive magazine changes without being too long for carry.

31B / 31S - Extended Mag Release - A fumbled magazine change can mean the difference between a win and a loss in any speed shoot competition. That's why most competitive shooters prefer our Extended Magazine Release with its wide checkered button for quick magazine changes with minimal movement.



#405B / 405S



#34 / 34SS



#34E / 34P



#458B / 458S



#313B / 313S



#315B / 315S



#101,70 / 101,80



#101S70 / 101S80



#336 / 336S



#12G

FRAME PARTS / SLIDE PARTS

405B / 405S - Oversize Mag Release - A fumbled magazine change can mean the difference between a win and a loss in any speed shooting competition. That's why most competitive shooters prefer our extended magazine release, with its oversize checkered button for quick magazine changes with minimal movement.

34 / 34SS - Extended Ejector - A combat pistol must reliably eject spent cases every time. Our Extended Combat Ejectors are designed to give optimal case clearance and endure the constant pounding of even the hottest loads. These Ejectors are fully machined from 4130 bar stock and heat treated for maximum durability. Fits fullsize 1911 style frames.

34E / 34P - Extended Ejector - A combat pistol must reliably eject spent cases every time. Our Extended Combat Ejectors are designed to give optimal case clearance and endure the constant pounding of even the hottest loads. These Ejectors are fully machined from 4130 bar stock and heat treated for maximum durability. Fits compact / officers 1911 style frames, 34P fits fullsize 9MM 1911 style frames.

458B / 458S - Plunger Tube - Fully machined bar stock plunger tube. Since a plunger tube basically becomes a permanent part of your pistol's frame this is certainly no place to use anything but the best.

313B / 313S - Hex Head Grip Screws - Give your pistol a custom look that will continue to look great even after being removed many times. No more burred screw slots.

315B / 315S - Complete Pin Set for 1911 Autos - A set of all the pins necessary to construct, rebuild, or recondition a 1911 style Auto pistol. Manufactured of high grade steel and heat treated to the proper hardness.

101,70 / 101,80 - Extractor - Fully machined from solid bar stock, then heat treated to provide optimum tension and long service life. They feature an extra deep hook for maximum strength and contact with the case rim. A high quality, properly adjusted extractor is quite possibly the most important component in a 1911.

101S70 / 101S80 - Extractor - Fully machined from solid bar stock, then heat treated to provide optimum tension and long service life. They feature an extra deep hook for maximum strength and contact with the case rim. A high quality, properly adjusted extractor is quite possibly the most important component in a 1911. Fits .38 Super 1911.

336 / 336S - Titanium Firing Pin - Lightweight titanium firing pin. #336 fits .45 ACP, #336S fits 9 mm / .38 Super.

12G - Group Gripper™ - Improve the accuracy of your 1911's stock barrel by adding a Group Gripper™. The Group Gripper™ is a modified recoil spring guide and barrel link that uses heavy spring tension to force the rear of the barrel up into the locking lugs in the slide.



#203G / 203C

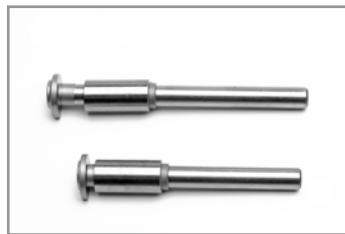

#25G / 25C

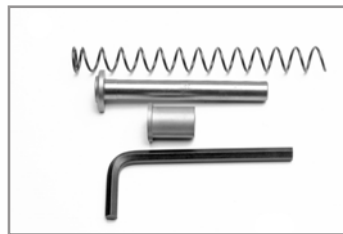

#25CO



#25RG



#148,5



#419



#33D



#33G / 33C



#33,O



#35

SLIDE PARTS

203G / 203C - Group Gripper™ - Combine the accuracy of a Group Gripper™ and the reliability of a full length two piece stainless steel guide rod for an unbeatable package. The Group Gripper™ is a modified recoil spring guide and barrel link that uses heavy spring tension to force the rear of the barrel up into the locking lugs in the slide. #203C fits Commander.

25G / 25C - Full Length Guide Rod - The one piece Full Length Guide Rod replaces your stock recoil guide without pistol modification. #25C fits Commander.

25CO - Full Length Guide Rod - There probably isn't a pistol that benefits more from a Full Length Guide Rod conversion than the Officers Model. First of all, you receive the typical reliability and accuracy improvements which are inherent with a two piece full length guide rod. Then we replace the failure prone stock plug with a highly reliable reverse plug and a single 24# spring.

25RG - Full Length Guide Rod - The Guide Rod & Reverse Plug are designed to be used with heavy taper cone barrels where the barrel bushing has been eliminated. For quick field stripping, the guide rod has been drilled and a staking pin is provided for pinning back the plug. Minor slide modification required for installation.

148,5 - Two-Piece Guide Rod - Many shooters prefer our Two-Piece Guide Rod for its ease of disassembly and reassembly. Once you remove the front half of the rod with the provided allen wrench, disassembly is identical to that of stock components.

419 - Medium Weight Guide Rod - The Medium Weight (3.25 ounces) Guide Rod provides a great compromise between gun balance and shot recovery time. Since the medium weight rod is built to the same dimensional specifications as our one piece steel rods, you can use standard #10G series recoil springs and SHOK-BUFFS®. This is a drop-in part and fits Government/ Gold Cup Models.

33D - Match Barrel - Now you can have superb accuracy (2" or less at 25 yds. with good ammo) without sending your pistol off to a master pistolsmith and waiting for months. Our "drop-in" barrel is exactly the same as the #33G match barrel, with the critical lock-up contact areas cut to a dimension that provides a good lock-up in most Colt and Springfield pistols*.

33G / 33C - Match Barrel - Wilson Combat® Match-Grade Barrels are known for their unsurpassed quality and accuracy. Wilson Combat® match barrels are fully machined from aircraft grade stainless steel forgings and heat-treated to R/C 40 for maximum service life. Critical manufacturing tolerances are held to less than .0005". 33C fits Commander.

33,O - Match Barrel - Wilson Combat® Match-Grade Barrels are known for their unsurpassed quality and accuracy. Wilson Combat® match barrels are fully machined from aircraft grade stainless steel forgings and heat-treated to R/C 40 for maximum service life. Critical manufacturing tolerances are held to less than .0005". Fits Officer's Model.

35 - Match Barrel - Wilson Combat® Match-Grade Barrels are known for their unsurpassed quality and accuracy. Wilson Combat® match barrels are fully machined from aircraft grade stainless steel forgings and heat-treated to R/C 40 for maximum service life. 6" ramped barrel.



#33DPR / 33DSR

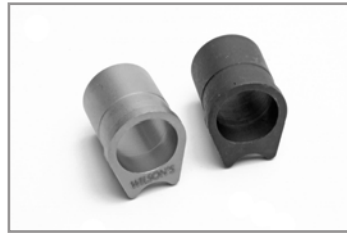

#29B / 29S

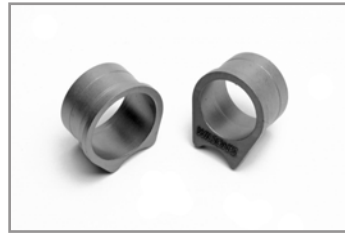

#29SC / 29CO



#142



#397

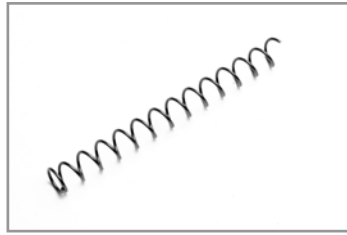

#10G GOVT.

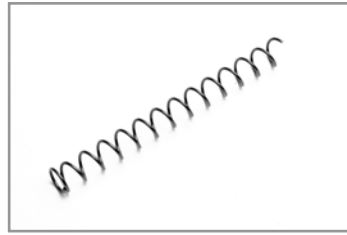

#10C COMM.

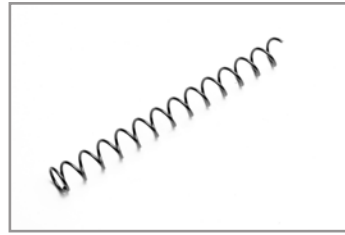

#10CO24

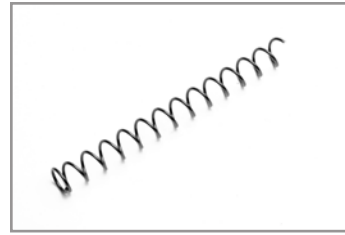

#10SC COMPACT



#26

SLIDE PARTS / SPRINGS

33DPR / 33DSR – Match Barrel - Ramped Match Barrel Stainless 9mm / Ramped Match Barrel Stainless .38 Super

29B / 29S - Barrel Bushing - Wilson Combat® Match-Grade Barrel Bushings are produced from top-quality steel for maximum reliability and wear. Our stainless steel bushings, #29S, are designed for .580 O.D. barrels and require only minor fitting. The #29B blued bushing is a pistolsmith part with considerably more material on the O.D. and I.D. for use with smaller barrels or when special situations require additional material.

29SC / 29CO - Barrel Bushing - Wilson Combat® Match-Grade Barrel Bushings are produced from top-quality steel for maximum reliability and wear. #29SC fits Commander models / #29CO fits Officer's models.

142 - Barrel Links - Our Barrel Links are fully machined from 416 stainless bar stock and hardened for maximum durability. Includes five link sizes with the #3 link being the stock equivalent, then two oversize and two undersize links.

397 - Multi-Comp - Adding a Multi-Comp compensator to your 1911 Auto is as fast and easy as changing out the barrel bushing. This ingenious new multi-port compensator features a built-in barrel bushing, three chambers, and seven exhaust ports for maximum recoil suppression. Requires Wilson #148-5" guide rod.

10G Series - Recoil Springs - Wilson Heavy Duty Recoil Springs are made combat tough to repeatedly take a pounding yet show a remarkably consistent performance every time a round is fired. Keeping a fresh recoil spring in your pistol will dramatically reduce the pounding your slide and frame receive. Fits Government size 1911, available in 8#, 9#, 10#, 12#, 13#, 15#, 16#, 17#, 18 1/2# and 22#.

10C Series - Recoil Spring - Wilson Heavy Duty Recoil Springs are made combat tough to repeatedly take a pounding yet show a remarkably consistent performance every time a round is fired. Keeping a fresh recoil spring in your pistol will dramatically reduce the pounding your slide and frame receive. Fits Commander size 1911, available in 12 # and 20#.

10CO24 - Recoil Spring - Wilson Heavy Duty Recoil Springs are made combat tough to repeatedly take a pounding yet show a remarkably consistent performance every time a round is fired. Keeping a fresh recoil spring in your pistol will dramatically reduce the pounding your slide and frame receive. Fits Officer's size 1911.

10SC Compact - Recoil Springs - Wilson Heavy Duty Recoil Springs are made combat tough to repeatedly take a pounding yet show a remarkably consistent performance every time a round is fired. Keeping a fresh recoil spring in your pistol will dramatically reduce the pounding your slide and frame receive. Fits Springfield Compact, available in 12#, 20# and 22#.

26 - Firing Pin Return Spring - The Firing Pin Return Spring should be replaced every 5,000 rounds. Our "extra power" spring will help reduce the risk of an accidental discharge should the pistol be dropped without reducing reliable ignition.



#27 / 27,OM

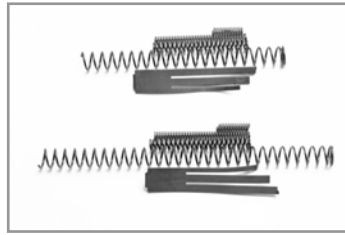

#316G / 316C

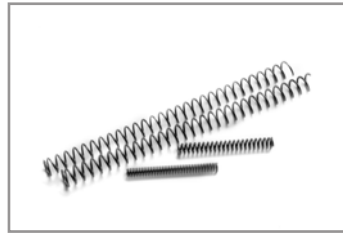

#324G



#364



#2B

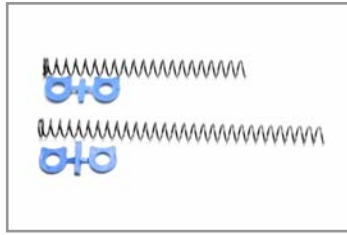

#2G / 2C



#64G / 64C



#22 / 22P



#267



#424,45 / 424,38

SPRINGS / SHOK-BUFF® / MAINTENANCE

27 / 27,OM - Mainsprings - Replace your stock mainspring with our "Reduced Power" Mainspring for a lighter trigger pull. The hammer will be much easier to cock by hand and ejection reliability will be improved. #27,OM fits Officer's Model.

316G / 316C - Spring Set - A set of all the springs necessary to construct, rebuild, or recondition a 1911 style Auto pistol. These springs are produced from the finest high tensile spring steel assuring a consistently smooth action, positive ignition, and proper timing. #316C fits Commander Model.

324G - Custom-Tune® Spring Kit - A properly tuned 1911 auto is unquestionably the finest combat pistol in the world. The first step when tuning your pistol is replacing the stock springs with Wilson Custom-Tune® Springs. These springs are produced from the finest high tensile spring steel, assuring a consistently smooth action, positive ignition, and proper timing. Once installed, your pistol will be Custom-Tuned for maximum reliability.

364 - Spring Caddy - Have you ever needed a spring for your 1911 auto and didn't have it? Do you have the right recoil spring for that new practice round? Don't get caught short. The Spring Caddy is a handy roll-up organizer containing the most commonly needed 1911 auto springs and accessories.

2B - SHOK-BUFF® - The Wilson SHOK-BUFF® prevents the slide from battering the frame during recoil by sandwiching a 1/10" thick poly fiber buffer between the slide and frame contact areas.

2G / 2C - SHOK-BUFF® Kit - This is a balanced kit containing two SHOK-BUFF® buffers and one heavy duty recoil spring. The SHOK-BUFF® should be changed out every 1,000 rounds and the recoil spring every 2,000 rounds. When the SHOK-BUFF® buffers are gone, it's time for a new kit. It's a great way to remember your recoil spring changes.

64G / 64C - SHOK-BUFF® / Guide Rod Kit - The SHOK-BUFF® Recoil System is a great value for the improved performance it gives your 1911 style auto. The full length guide rod controls the recoil spring to keep it from kinking, which means smoother, more reliable functioning and longer spring life. The original SHOK-BUFF® recoil absorbing, poly fiber buffers prevent the slide from pounding the frame, giving longer gun life and softer recoil. #64C fits Commander Model.

22 / 22P - Bushing Wrench - A barrel Bushing Wrench is an indispensable part of every shooter's kit and is absolutely necessary for disassembling guns with tight-fitting bushings. The #22 fits all 1911 autos except *Colt Officers Model. The super- tough polymer bushing wrench #22P is perfect for removing barrel bushings on Government and Officers style 1911s without scratching the gun.

267 - Silicone Cleaning Cloth - Completely removes rust producing fingerprints and is ideal for use on the range after gun handling.

424,45 / 424,38 - Chamber Cleaning Tool - Powder residue, lead and bullet lubrication can get packed in your barrel's chamber, which can cause feeding and extraction malfunctions. Unfortunately, your .45 bore brush is the wrong diameter and usually too soft to remove chamber contamination. You need a Wilson "Chamber Cleaning Tool". This tough little tool has a sturdy Delrin handle and very stiff stainless bristles to thoroughly clean your chamber. #424,38 - fits .38 Super & 9mm chambers.



#424,45B / 424,38B



#418



#359T / 360T



#361



#493



#494



#401



#363



#472B / 472G



#553

MAINTENANCE / RANGE GEAR

424,45B / 424,38B – Chamber Cleaning Tool Replacement Brushes, #424,45B fits .45 chamber cleaning tool, #424,38B fits .38 Super / 9mm chamber cleaning tool.

418 – Ultima-Lube® - Universal, 10cc Syringe. Virtually eliminates metal-to-metal friction through the use of high-quality conventional lubricants as a carrier and electrochemical ionization utilizing anti-friction metal treatment technology.

359T / 360T - Ultima-Lube® - Oil, Virtually eliminates metal-to-metal friction through the use of high-quality conventional lubricants as a carrier and electrochemical ionization utilizing anti-friction metal treatment technology. #359T – 10cc Syringe, #360T – 2 oz. Squeeze Bottle.

361 – Ultima-Lube® - Grease, 10cc Syringe. Virtually eliminates metal-to-metal friction through the use of high-quality conventional lubricants as a carrier and electrochemical ionization utilizing anti-friction metal treatment technology.

493 - Ultima-Lube® - Combo Pack (5cc tube of grease, 5cc tube of oil and a 2 ounce bottle of bore solvent) - Virtually eliminates metal-to-metal friction through the use of high-quality conventional lubricants as a carrier and electrochemical ionization utilizing anti-friction metal treatment technology.

494 – Ultima-Lube® - Bore Solvent, 2 oz. Bottle - Ultima Lube® bore solvent quickly and aggressively dissolves and strips away powder residue, metal deposits, lead, and brass fouling without harming the integrity of the metal surface.

401 - Maintenance Manual - In this informative technical manual, Bill Wilson shares many of the little tricks he's learned over the past years on proper maintenance of the 1911 auto. Features include: complete disassembly/re-assembly, how to check for proper extractor adjustment, how to check major components for proper fit and function, proper lubrication and other useful information for the 1911 owner. 65 pages, four color.

363 - Logo Ear Protectors - These quality lightweight ear protectors are custom made for us by Peltor and have a noise reduction rating of 22db. Protect your hearing in style! #363H - Ear Protector Belt Holder.

472B / 472G - Range Bag - Ideal gear bag for the serious shooter. Just enough room for all the gear you need for a day at the range or an IDPA match, yet compact. 14" L x 8" W x 8" H overall with one 14" L x 4" W x 6" H inside compartment and two 7" L x 4" W x 6" H compartments. Marked with Wilson Combat® logo.

553 – Large Range Bag - 16" long, 10" high, and 9" wide. The carry handles are 2" wide webbing with a padded grip, and it has a 2" shoulder strap. The inside is fitted with 2 large padded pockets, for ammo, tools, lunch, whatever you take with you to the range. The inside also has a padded divider.

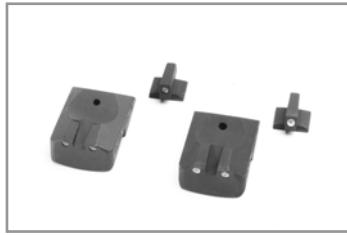

#463T / 463TW

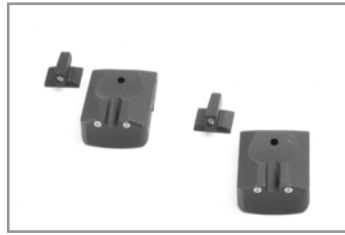

#463TU / 463TOU

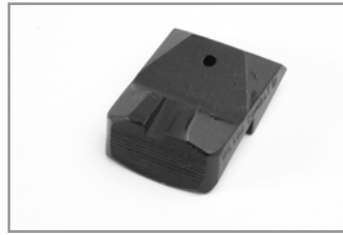

#463TBS



#463TK / 463TKC



#428W



#428WT / 428WTW



#428WPT / 428WPTW

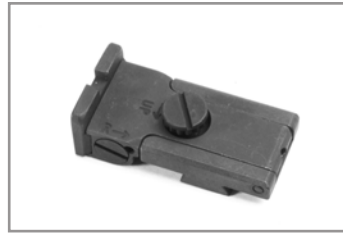

#428B

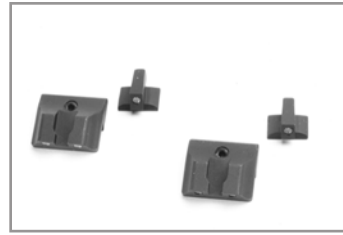

#367T / 367TO

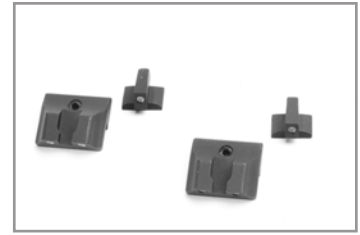

#367D

SIGHTS

463T / 463TW - Tactical Combat Pyramid® Sights - The rugged Tactical Combat Pyramid® tritium fixed sight set features a lo-profile/snag-free design while retaining a crisp sight picture. The unique "Combat Pyramid®" sight picture automatically speeds up sight acquisition for faster-aimed fire. #463TW has white outlines around tritium.

463TU / 463TOU - Tactical Combat Pyramid® Sights - The rugged Tactical Combat Pyramid® tritium fixed sight set features a lo-profile/snag-free design while retaining a crisp sight picture. The unique "Combat Pyramid®" sight picture automatically speeds up sight acquisition for faster-aimed fire. Sight notch is U shaped instead of traditional square notch. #463TOU fits Officer's Model.

463TBS - Tactical Boot Sight - The Tactical Boot Sight has a vertical face machined about the half-way point down the ramp of our combat sight. For single-handed slide operation, the vertical face can be lodged against any firm surface (such as an outside corner of a wall, a door jamb, your belt – or even your boot heel) where a firm push on the pistol grip will enable you to manipulate the slide.

463TK / 463TKC - Tactical Combat Pyramid® Sights for Kimber - The rugged Tactical Combat Pyramid® fixed sight set features a lo-profile/snag-free design while retaining a crisp sight picture. The unique "Combat Pyramid®" sight picture automatically speeds up sight acquisition for faster-aimed fire. #463TK fits Kimber fullsize, #463TKC fits Kimber compact.

428W - Lo-Profile Adjustable Sights - Each component part of the Wilson adjustable sight is precision CNC machined from solid bar stock gun steel, then hardened to provide maximum durability. The result is a smooth precision 3/16" @ 25 yds. click adjustment sight that locks in your windage and elevation adjustments and won't shoot loose.

428WT / 428WTW - Lo-Profile Adjustable Sights with tritium - Each component part of the adjustable sight is precision CNC machined from solid bar stock gun steel, then hardened to provide maximum durability. The result is a smooth precision 3/16" @ 25 yds. click adjustment sight that locks in your windage and elevation adjustments and won't shoot loose. #428WTW has white outlines around tritium.

428WPT / 428WPTW - Lo-Profile Pyramid Adjustable Sights with tritium - Each component part of the Wilson adjustable sight is precision CNC machined from solid bar stock gun steel, then hardened to provide maximum durability. The result is a smooth precision 3/16" @ 25 yds. click adjustment sight that locks in your windage and elevation adjustments and won't shoot loose. Pyramid blade, #428WPTW has white outlines around tritium.

428B - Lo-Profile Adjustable Sights - Each component part of the Wilson adjustable sight is precision CNC machined from solid bar stock gun steel, then hardened to provide maximum durability. The result is a smooth precision 3/16" @ 25 yds. click adjustment sight that locks in your windage and elevation adjustments and won't shoot loose. Fits slides with existing Bo-Mar® cut.

367T / 367TO - Nite-Eyes™ - Lo-profile snag-free sights provide a well-defined sight picture, making them the ultimate combat sight under all light conditions. The front 1911 auto sights are dovetail mounted (.300" x 60degree) for positive sight retention.

367D - Snag-Free Lo-Profile Sights - Provide a well-defined sight picture. The front 1911 auto sights are dovetail mounted (.300" x 60 degree) for positive sight retention. White dot sight picture.



#351AAFS



#351TFS



#351PFS



#351AEFS



#351AFFS



#351ACFS



#351EFS



#351LFS



#351AFS



#351MFS

GRIPS

G10 - These glass-epoxy laminates are specified for their extremely high strength and high dimensional stability over temperature. This material is used extensively in the electronics industry because its water absorption ability is extremely minimal and the G10 line of materials are not electrically conductive.

MICARTA® - Has a higher tensile strength than steel. This material will not swell, warp, or crack with changes in temperature. It is an excellent insulator against heat. Unlike other high-end grips, these stay cool and comfortable. When milled, Micarta® gives a highly slip resistant surface.

Cocobolo - A very heavy, tough and strong wood. The grain is usually straight, but it is occasionally interlocked. Cocobolo is a very durable natural material. Natural oils in the wood tend to promote waterproofing. They also impart a waxy appearance to the wood when it is rubbed with a cloth.

351AAFS - Grips, Govt., G10, Starburst Pattern, Black

351TFS - Grips, Govt., G10, Diagonal Pattern, Black

351PFS - Grips, Govt., G10, Diamond Pattern, Black

351AEFS - Grips, Govt., G10, Full Checkered, Double Diamond, Black

351AFFS - Grips, Govt., G10, Full Checkered, Black

351ACFS - Grips, Govt., G10, Starburst Pattern, Flat, Black

351EFS - Grips, Govt., Micarta®, Black Wavy

351LFS - Grips, Govt., Micarta®, Starburst Green

351AFS - Grips, Govt., Cocobolo, Full Checkered, Double Diamond

351MFS - Grips, Govt., Cocobolo, Starburst



#351BFS



#351NFS



#351FFS



#NW95



#351AACP



#351UCP



#351PCP



#351AECF



#351NCP

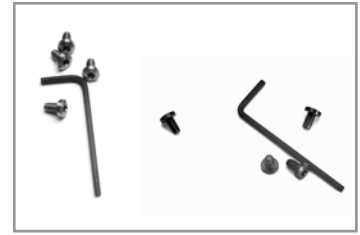

#313B / 313S

GRIPS

Elephant Ivory - The great beauty of elephant ivory is due to the warm creamy color and its rich grain patterns. Ivory is the choice of carving materials and it takes a natural shine which is as lustrous as rubbed lacquer.

351BFS - Grips, Govt., Cocobolo, Full Checkered

351NFS - Grips, Govt., Cocobolo, Slim Line

351FFS - Grips, Govt., Elephant Ivory

NW95 - Crimson Trace Laser Grips for 1911 Govt. / Commander

351AACP - Grips, Compact, G10, Starburst Pattern, Black

351UCP - Grips, Compact, G10, Diagonal Pattern, Black/Grey

351PCP - Grips, Compact, G10, Diamond Pattern, Black

351AECF - Grips, Compact, G10, Full Checkered, Double Diamond, Black

351NCP - Grips, Compact, Cocobolo, Slim Line

313B / 313S - Hex Head Grip Screws will give your pistol a custom look that will continue to look great even after being removed many times. No more burred screw slots. Available in blued carbon steel or stainless steel.

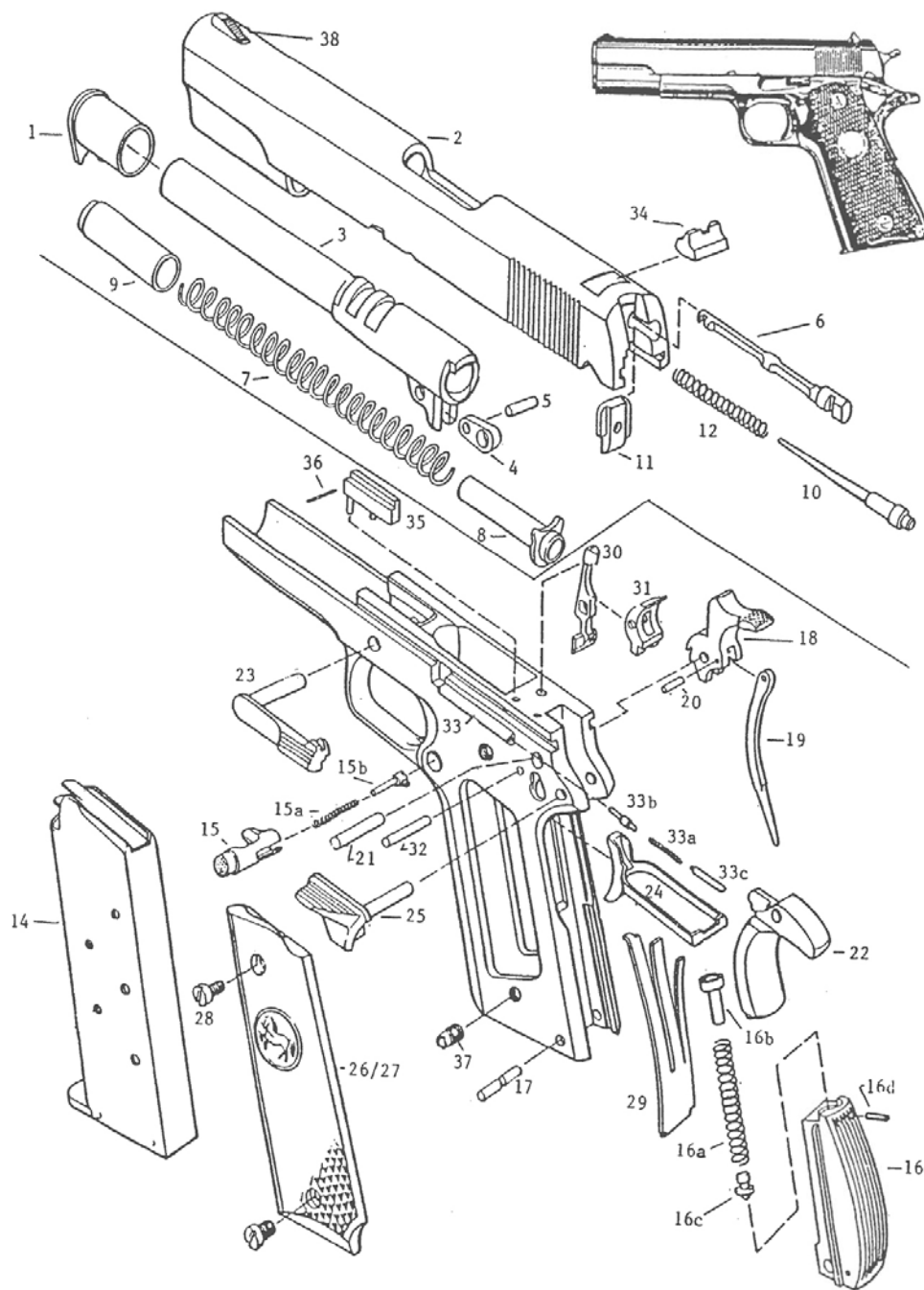

R5	..	BARREL LINK PIN (BLUE)
R5S	..	BARREL LINK PIN (STAINLESS)
R8	..	RECOIL SPRING GUIDE (BLUE)
R9	..	RECOIL SPRING PLUG (BLUE)
R9S	..	RECOIL SPRING PLUG (STAINLESS)
R10,38	..	FIRING PIN, 38
R10,45	..	FIRING PIN, 45
R11	..	FIRING PIN STOP (BLUE)
R11S	..	FIRING PIN STOP (STAINLESS)
R12	..	FIRING PIN SPRING
R15	..	MAGAZINE CATCH (BLUE)
R15S	..	MAGAZINE CATCH (STAINLESS)
R15A	..	MAGAZINE CATCH SPRING
R15B	..	MAGAZINE CATCH LOCK (BLUE)
R15BS	..	MAGAZINE CATCH LOCK (STAINLESS)
R16A	..	MAINSRING
R16B	..	MAINSRING GAP (BLUE)
R16BS	..	MAINSRING GAP (STAINLESS)
R16C	..	HOUSING PIN RETAINER (BLUE)
R16CS	..	HOUSING PIN RETAINER (STAINLESS)
R16D	..	MAINSRING CAP PIN (BLUE)
R16DS	..	MAINSRING CAP PIN (STAINLESS)
R17	..	HOUSING PIN (BLUE)
R17S	..	HOUSING PIN (STAINLESS)
R19	..	HAMMER STRUT (BLUE)
R19S	..	HAMMER STRUT (STAINLESS)
R20	..	HAMMER STRUT PIN (BLUE)
R20S	..	HAMMER STRUT PIN (STAINLESS)
R21	..	HAMMER PIN (BLUE)
R21S	..	HAMMER PIN (STAINLESS)
R21TRIM	..	HAMMER PIN FOR AMBI (BLUE)
R21STRIM	..	HAMMER PIN FOR AMBI (STAINLESS)
R28	..	GRIP SCREW (BLUE)
R28S	..	GRIP SCREW (STAINLESS)
R29	..	SEAR SPRING
R30	..	DISCONNECTOR
R31	..	SEAR
R32	..	SEAR PIN (BLUE)
R32S	..	SEAR PIN (STAINLESS)
R32TRIM	..	SEAR PIN FOR AMBI (BLUE)
R32STRIM	..	SEAR PIN FOR AMBI (STAINLESS)
R33	..	PLUNGER TUBE (BLUE)
R33S	..	PLUNGER TUBE (STAINLESS)
R33A	..	PLUNGER TUBE ASSEMBLY (BLUE)
R33AS	..	PLUNGER TUBE ASSEMBLY (STAINLESS)
R36	..	EJECTOR PIN (BLUE)
R36S	..	EJECTOR PIN (STAINLESS)
R37	..	GRIP SCREW BUSHING (BLUE)
R37S	..	GRIP SCREW BUSHING (STAINLESS)



#69B5 / 69S5 / 69EX



#2BGL

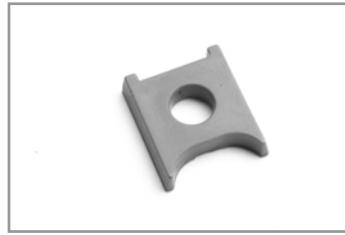

#411



#413

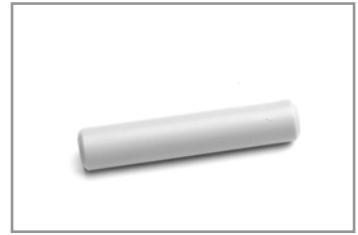

#439

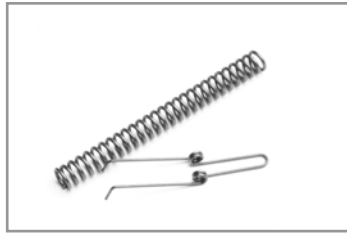

#176



#178



#246

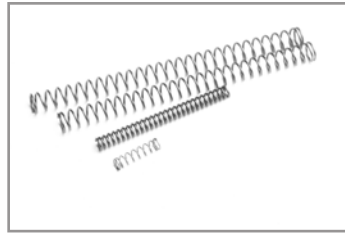

#321



#NW96 / NW96D

NON-1911 PARTS

69B5 / 69S5 / 69EX - Full Moon Clips - Hold six rounds of .45 ACP ammo each. These clips allow speed reloads/unloading of Smith & Wesson* Model 625, Model 25-2, or Model 1917s. #69EX is an easy way to extract cases from full moon clips. Works equally well with either hand and does not damage the clip or cases.

2BGL - The Wilson SHOK-BUFF® - Prevents the slide from battering the frame during recoil by sandwiching a 1/10" thick poly fiber buffer between the slide and frame contact areas. Fits: Glock Models 17/ 17L/ 18/ 19/ 20/ 21/ 22/ 23/ 24/ 24C/ 31/ 32

411 - SHOK-BUFF® - With a Shok-Buff® in your rifle, you will immediately notice the sharp metal to metal contact of the action has been reduced to a soft, cushioned sound. Shok-Buffs® for rifles are made super-tough to last about 5,000 rounds or more depending on the ammunition used and condition of the firearm. Fits: Ruger Mini-14

413 - SHOK-BUFF® - With a Shok-Buff® in your rifle, you will immediately notice the sharp metal to metal contact of the action has been reduced to a soft, cushioned sound. Shok-Buffs® for rifles are made super-tough to last about 5,000 rounds or more depending on the ammunition used and condition of the firearm. Fits: AK-47, MAK-90, Valmets

439 - SHOK-BUFF® - With a Shok-Buff® in your rifle, you will immediately notice the sharp metal to metal contact of the action has been reduced to a soft, cushioned sound. Shok-Buffs® for rifles are made super-tough to last about 5,000 rounds or more depending on the ammunition used and condition of the firearm. Fits: Ruger 10-22

176 - CUSTOM-TUNE® Spring Kits - Designed to easily and inexpensively improve your revolvers' action and functionality. These quality spring kits feature the finest gun springs available, made from high-tensile spring wire, for the finest possible action tuning jobs. Kits include the various springs necessary to assure reliable function, smooth operation and long life. Fits: Ruger Single Action

178 - CUSTOM-TUNE® Spring Kits - Designed to easily and inexpensively improve your revolvers' action and functionality. These quality spring kits feature the finest gun springs available, made from high-tensile spring wire, for the finest possible action tuning jobs. Kits include the various springs necessary to assure reliable function, smooth operation and long life. Fits: S&W K, L, & N Frame

246 - CUSTOM-TUNE® Spring Kits - Designed to easily and inexpensively improve your revolvers' action and functionality. These quality spring kits feature the finest gun springs available, made from high-tensile spring wire, for the finest possible action tuning jobs. Kits include the various springs necessary to assure reliable function, smooth operation and long life. Fits: Ruger GP-100

321 - CUSTOM-TUNE® Spring Kits - Designed to easily and inexpensively improve your revolvers' action and functionality. These quality spring kits feature the finest gun springs available, made from high-tensile spring wire, for the finest possible action tuning jobs. Kits include the various springs necessary to assure reliable function, smooth operation and long life. Fits: S&W J Frame

NW96 - Crimson Trace Laser Grips - S&W J-Frame round butt revolvers. #NW96D - S&W J-Frame Defender model.

Low Profile - Designed for the person that carries all day long and demands maximum comfort and concealability. (A)

Rapid Response® - Designed for maximum drawing speed without sacrificing the features required for a quality carry holster. (B)

Featherweight IWB - Is not only one of the lightest IWB holsters available, it's really comfortable too. (Not Shown)

Summer Companion - Features a stitched-in sight track for a smooth draw and clean sight picture. (C)

Double Mag Pouch - Wilson Combat® magazine pouches are crafted with the same attention and care we give our holsters. (D)

Single Snap Mag Pouch - These magazine pouches look sharp, yet they're built to be a highly functional part of your rig. (E)

Belt - Wilson Combat® belts are cut from the finest top grain cowhide, or sharkskin with a cowhide inner lining for additional rigidity and proper support of your firearm. (F)



CUSTOM LEATHER

The right holster – one that allows you to carry your favorite Wilson Combat® pistol comfortably, safely, and ready for use – is an absolute necessity. Our custom handgun leather line is deservedly considered one of the best in the world, developed and used by professionals who carry, use, and work with guns every day. We offer Kydex holsters, affordably priced premium cowhide and sharkskin holsters, and a line of exotic leather holsters. We also have matching belts for the holster you select, and the other accessories you need for personal defense or competition.

More Info And Additional Products



www.wilsoncombat.com
800-955-4856

Practical - If your need is for a holster that's equally well suited for concealed carry or range use, the Practical® is the holster for you. (A)

Tiger Shark® - Designed with maximum convenience in mind, while providing much greater stability than what you'd find in most other paddle holsters. (B)

Tactical Paddle - The Kydex "Tactical" version of our popular Tigershark® paddle holster is a real workhorse. (C)

Tactical Assault - Equally at home for special response or range use, yet is also ideal for concealed carry. (D)

Open Front Mag Pouch - Wilson Combat® magazine pouches are crafted with the same attention and care we give our holsters. (E)

Combo Light Pouch - If you plan to carry concealed, you should always have a spare magazine and your flashlight. (F)

Single Light Pouch - Our snap on style flashlight pouch is designed to carry the Surefire 6Z combat light lens down so it's natural to draw it ready to use and also protect the lens. (Not Shown)



CUSTOM LEATHER

More Info And Additional Products



www.wilsoncombat.com
800-955-4856



Adjustable Trak-Lock® Ghost Ring Rear Sight, Ramp-Type Front Sight with Tritium Self-luminous Insert

Extended Magazine Tube, Total Capacity: 6+1 Rounds

Sidesaddle Shell Carrier, Extended Capacity: 4 or 6 Rounds

Synthetic Speedfeed® Buttstock and Surefire® Tactical Fore Grip with 11,000 Candlepower Light

High-Visibility, Non-Binding Follower

Extra-Power Heavy-Duty Stainless Magazine Tube Spring

Jumbo Head Safety

Multi-Purpose Tactical CQB Sling

Buttstock Swivel and Rigid Magazine Tube Sling Mount

Armor-Tuff® Finish

Shown w/Knox Stock Upgrade



STANDARD MODEL

The Standard Model incorporates the features many of our owners want most in their defensive shotguns, in a value-packed package. The 18" cylinder-bore barrel with 3" magnum chamber will handle your ammunition of choice – and the included magazine extension tube offers increased capacity for a total of 7 rounds. We include an extra-power heavy-duty stainless magazine spring for sure shell feeding in any situation, and a high-visibility, non-binding follower to indicate an empty-magazine tube at a glance. The Standard Model also includes your choice of a four or six round receiver-mounted Sidesaddle shell carrier – in a critical re-load situation your extra ammo is quickly available in a no fumbling, load-by-feel manner.

More Info And Additional Products



www.wilsoncombat.com
800-955-4856

Adjustable Trak-Lock® Ghost Ring Rear Sight, Ramp-Type Front Sight with Tritium Self-luminous Insert

Extended Magazine Tube, Total Capacity: 6+1 Rounds

Synthetic Speedfeed® Buttstock and Fore Grip

High-Visibility, Non-Binding Follower

Extra-Power Heavy-Duty Stainless Magazine Tube Spring

Jumbo Head Safety

Multi-Purpose Tactical CQB Sling

Buttstock Swivel and Rigid Magazine Tube Sling Mount

Armor-Tuff® Finish



BORDER PATROL MODEL

The Border Patrol Model has an outstanding, well-earned reputation as the workhorse of Wilson Combat®'s shotguns. The US Border Patrol uses thousands for daily service, in some of the harshest conditions a firearm may encounter. Unequaled quality and relentless reliability are the minimum requirements demanded of a firearm for its mission – and the Border Patrol Model has met the expectations for years.

More Info And Additional Products



www.wilsoncombat.com
800-955-4856

Replace All Worn and / or Damaged Parts

Convert to 3" (If Applicable)

Convert Shell Feed to Flexitab Anti-jam System

Install New Factory Remington® Synthetic Buttstock and Fore Grip

(NOTE: Old Buttstock and Foregrip Will Not Be Returned with Remington® Steal Package)

Install New Factory Remington® Magazine Spring and Follower

Replace Safety with Jumbo Head Safety

Strip and Parkerize All External Parts

Replace Trigger Assembly with a Professionally Remanufactured Trigger Unit



REMINGTON® STEAL

(Note: The Remington® Steal Package is only available on 12 ga. Remington® model 870 shotguns. The rebuild contains both new and professionally reconditioned Remington® factory parts. This rebuild is intended for tactical, combat and competitive use and as such is not supplied with a magazine tube plug.)

More Info And Additional Products



www.wilsoncombat.com
800-955-4856

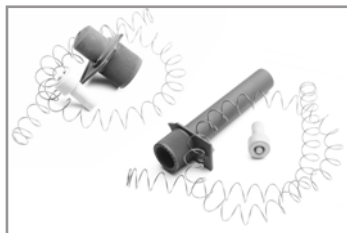

#SGET-RH 1 / 2

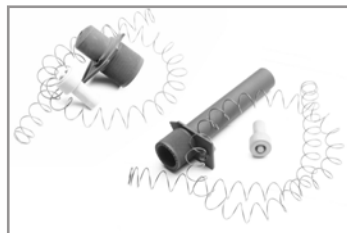

#SGET-V 1 / 2

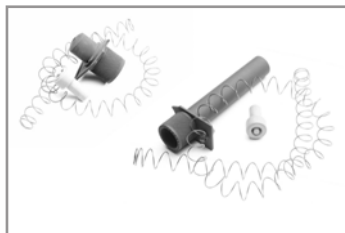

#SGET-LH 1 / 2

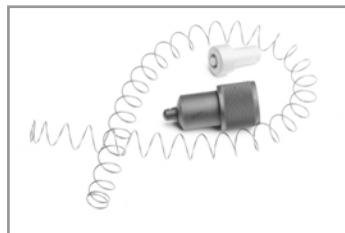

#SGET-QDS-U-1



#SG-JHS



#SGTL2-TF-12 / TFR-12

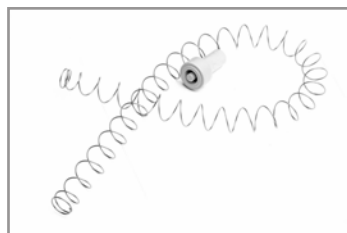

#SG-HVF / SGSFK-ST



#SGSS-U-6 / 4



#SGPGS



#SGQRF

SHOTGUN PARTS

SGET-RH1 / 2 - Magazine Tube Extension - ScattergunTechnologies™ magazine tube extensions are so tough they were selected for use by the US Secret Service and the US Border Patrol. The one or two round extensions add capacity to your tactical shotgun and provide a right hand side sling mount. #SGET-RH1 is a 1 shot extension, #SGET-RH2 is a 2 shot extension.

SGET-V1 / 2 - Magazine Tube Extension - ScattergunTechnologies™ magazine tube extensions are so tough they were selected for use by the US Secret Service and the US Border Patrol. The one or two round extensions add capacity to your tactical shotgun and provide a bottom sling mount. #SGET-V1 is a 1 shot extension, #SGET-V2 is a 2 shot extension.

SGET-LH1 / 2 - Magazine Tube Extension - ScattergunTechnologies™ magazine tube extensions are so tough they were selected for use by the US Secret Service and the US Border Patrol. The one or two round extensions add capacity to your tactical shotgun and provide a left hand side sling mount. #SGET-LH1 is a 1 shot extension, #SGET-LH2 is a 2 shot extension.

SGET-QDS-U-1 - Magazine Tube Extension - Developed to satisfy the needs of our law enforcement customers. The quick detach magazine tube extension allow rapid detachment of your 3-point tactical sling so movement in close quarters situations is not hampered.

SG-JHS - Jumbo Head Safety - Allows you to rapidly and positively snap the safety off as you mount the weapon for a quick shot. Blue finish. Fits all Remington® M870, M1100 and M1187 models.

SGTL2-TF-12 / TFR-12 - TRAK-LOCK® Sight Set - The TRAK-LOCK® II Tactical Sight is the #1 choice of Law Enforcement professionals worldwide! The TRAK-LOCK® II gives you high speed sight acquisition and improved accuracy. This rugged sight set is fully CNC machined from bar stock steel and features a tritium insert in the front sight for low light use. Both elevation and windage are quickly and easily adjusted with a single hex head screw. #SGTL2-TFR-12 has tritium in front and rear sights.

SG-HVF / SGSFK-ST - High Visibility Follower - #SGSFK-ST includes a high visibility follower and stainless magazine spring for standard magazine tube shotguns.

SGSS-U-6 / 4 - Sidesaddle - Fits Remington® 870, 1100 and 1187 in 6rd or 4rd.

SGPGS - Collapsible Stock Kit - Unique adapter allows you to mount a four position AR style collapsible stock and pistol grip on your Remington® 870. Being able to adjust the length of pull on your tactical shotgun gives you numerous advantages when wearing armor or doing room entries. Pistol grip helps with shotgun control and recoil management. Includes four position stock, adaptor and pistol grip.

SGQRF - Quad Rail Forearm - Allows you to mount useful accessories on your Remington® 870 such as a weapons light or laser aiming device. The lightweight and user friendly forearm installs easily with no special tools and does not require any modification to your shotgun.

Forged Upper (flat top) and Lower Receivers

Premium Wilson Combat® Match-Grade Fluted Barrel, 16.25" OAL

Wilson Combat® Tactical Muzzle Brake

Free-Float Ventilated Quad Rail Aluminum Handguard

ERGO® Ergonomically Correct Pistol Grip

Crisp 3-3.5# Trigger Pull

Premium Mil-Spec Bolt and Bolt Carrier, NP-3 Coated

Hard Anodize Finish on Receivers

Mil-Spec Black Manganese Phosphate (Parkerized) on Barrel and Steel Components or Armor-Tuff® Finish.

Magazine Capacity, Accepts all M-16/AR-15 Style Magazines

Includes:

(1) 20 rd. Magazine

Nylon Tactical Rifle Case

Shown - UT-15AQ w/TRP Upgrade



UT-15 URBAN TACTICAL

More Info And Additional Products



www.wilsoncombat.com
800-955-4856

Wilson Combat®'s UT-15 Urban Tactical model is an ideal all-around tactical or sporting semi-auto carbine. It offers precise accuracy and fast handling versatility in a lightweight package, with our famous unequalled quality, relentless reliability, and superior service. We start with precision CNC machined upper and lower receivers, using high-quality 7075 T6 aluminum forgings. The upper utilizes a flat-top receiver and a 16.25" free-floated, fluted, match grade barrel. Uppers and lowers are hand-matched by a master riflemith.

Forged Upper (flat top) and Lower Receivers

Premium Wilson Combat® Match Grade M-4 Style Barrel, 16.25" OAL

Wilson Combat® Tactical Muzzle Brake

ERGO® Ergonomically Correct Pistol Grip

Crisp 3-3.5# Trigger Pull

Premium Mil-Spec Bolt and Bolt Carrier, NP-3 Coated

Hard Anodize Finish on Receivers

Mil-Spec Black Manganese Phosphate (Parkerized) on Barrel and Steel Components or Armor-Tuff® Finish

Magazine Capacity, Accepts All M-16/AR-15 Style Magazines

Includes:

(1) 20 rd. Magazine

Nylon Tactical Rifle Case

Shown - M-4TAQ w/Optimal Accessories



M-4T M4 CARBINE

More Info And Additional Products



www.wilsoncombat.com
800-955-4856

If you need accuracy and fast handling versatility – such as close quarters combat, personal or home defense, etc. – our M-4T Tactical Carbine may be your best choice. Lightweight, less than 36" overall length with as much as 30 rounds available without a reload – this is a potent force for everything from a Tactical Response® entry situation to home defense. The M-4T Tactical Carbine is also widely used for a sport rifle. Its light weight, compact size, and dependable performance in all weather conditions assure excellence in the field. If you enjoy sport shooting in any of its forms, the M-4-T is pure fun with exceptional performance.

Forged Upper (Flat Top) and Lower Receivers

Premium Wilson Combat® Match Grade Lightweight Barrel, 16.25" OAL

Free Floated Aluminum Handguard

Wilson Combat® Tactical Muzzle Brake

ERGO® Ergonomically Correct Pistol Grip

Crisp 3-3.5# Trigger Pull

Premium Mil-Spec Bolt and Bolt Carrier, NP-3 Coated

Hard Anodize Finish on Receivers.

Mil-Spec Black Manganese Phosphate (Parkerized) on Barrel and Steel Components or Armor-Tuff® Finish

Magazine Capacity, Accepts All M-16/AR-15 Style Magazines

Includes:

(1) 20 rd. Magazine

Nylon Tactical Rifle Case

Shown - TL-15AQ w/Optional Accessories



TL-15 TACTICAL LIGHTWEIGHT CARBINE

If lightweight, fast-handling and Wilson reliability is what you demand in your next carbine, you need a Tactical Lightweight Carbine. Equally at home on the range, in the field or the patrol car. Designed to be the lightest possible multi-use tactical carbine in the Wilson Combat® rifle family. Comes standard with a collapsible stock, Ergo pistol grip, free floated aluminum handguard and match grade lightweight barrel. As a tactical carbine should be, light, fast-acting and ready to go.

More Info And Additional Products



www.wilsoncombat.com
800-955-4856

Forged Upper (Flat Top) and Lower Receivers

Premium Wilson Combat® Match Grade Super Sniper Barrel, 20" OAL

Free Floated Aluminum Handguard

ERGO® Ergonomically Correct Pistol Grip

Crisp 3 3.5# Trigger-Pull

Premium Mil-Spec Bolt and Bolt Carrier, NP-3 Coated

Hard Anodize Finish on Receivers

Magazine Capacity, Accepts All M-16/AR-15 Style Magazines

Includes:

(1) 20 rd. Magazine

Nylon Tactical Rifle Case

Available With Armor-Tuff® Finish

Shown w/Optional Accessories



SS-15 SUPER SNIPER

There are times when extreme accuracy and the ability for rapid follow-up shots are the most important criteria in selecting a rifle. Those were the primary objectives the engineers at Wilson Combat® were working toward when they designed the SS-15 Super Sniper – and the result far exceeded our expectations. It has a 20" long, 1-in-8 twist, heavy-weight, fluted, stainless steel premium match-grade barrel – optimized for accuracy with the longer, heavier bullets frequently used for longer range shooting. The crispness of the trigger is unequalled in AR style rifles; it is tuned for a 3 – 3.5 pound pull. This gun is engineered, designed, and built to deliver un-matched accuracy at 300, 400, or even 500 yards – and it does, in an almost unbelievable fashion.

More Info And Additional Products



www.wilsoncombat.com
800-955-4856



#TTU



#TR-FUFS2

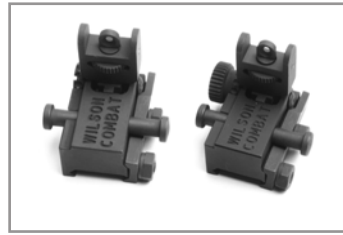

#TR-FURS / 2K / 2C



#TR-QRH-WS



#TR-CHR



#TR-EBR



#TR-MCPL



#TR-VGRIP



#TR-VFH



#TR-EGB

RIFLE PARTS

TR-TTU - Tactical Trigger Unit® – The TTU® is without doubt the world's most advanced DROP-IN trigger unit. All parts are fully CNC machined from stainless steel and then melonite coated (think Glock slide) for maximum durability. Assembled with stainless steel springs in a hard anodized aluminum housing utilizing standard pins. The trigger pull is preset at a crisp 3 ½ # to 3 ¾ #.

TR-FUFS2WC – Flip-Up Front Sight - A great complement to our FURS (flip up rear sight), the FUFS2WC (flip up front sight) now offers you the ability to have a complete backup to your optics equipped AR Style rifle. CNC machined from only the finest materials, finished, and hardened to last a life time. Easy to operate and locks solidly in place when needed, but low enough profile when not in use will not interfere with use of optics.

TR-FURS / 2K / 2C - Flip-Up Rear Sight - Our unique, new, flip-up sight for AR-15 style rifles is one of the most versatile available. Key features include: rock-solid 2 bolt mounting system, bi-directional adjustment for both windage and elevation, positive mount in the upward position, improved sight picture with a large aperture peep sight. 2K has knurled windage screw, 2C has coin slot windage screw.

TR-QRH-WS - Tactical Quad-Rail - Our unique Quad-Rail gives you a more comfortable hand hold on the forend than you would expect from a custom rifle, while maintaining the four rails for accessories. The full length top and bottom rails offer 7 ¼" of usable picatinny rail, while the sides have 1 1/2" of rail for mounting lights, lasers, slings, etc...

TR-CHR - Extended Charging Handle - Adding 1 inch to the charging handle with a forward bend allows you to chamber ammunition without taking your eyes off the target. By allowing you to lock your bolt back fast, the charging handle extension also permits rapid clearance of malfunctions.

TR-EBR - Oversize Bolt Release - The Wilson Combat® oversize bolt release is designed to assist you in the fastest possible reloads in your tactical rifle. Fully serrated and CNC machined out of bar stock steel for maximum durability, the bolt stop is also easy to install.

TR-MCPL - The Mag Coupler allows anyone with a need for high ammo capacity to carry two magazines with their rifle. You won't waste time searching for the second one, just switch the magazines already attached to your rifle and save crucial seconds! The Mag Coupler holds two 30rd. magazines together with rock solid strength to ensure that they both operate as one unit.

TR-VGRIP - Vertical Fore Grip - This high quality vertical foregrip will enhance your control of your AR-15 style rifle. Fully CNC machined from aluminum and over-molded with rubber, the foregrip is comfortable on the hand and it does not get hot. The vertical grip securely attaches to any picatinny rail.

TR-VFH - Vortex Flash Hider - Four specially angled flutes dissipate the gas but contain the unburned powder allowing increased residual burn for less visible flash. The Vortex incorporates a helix design essentially tightening itself when the weapon is fired and helps align exiting barrel gas to improve accuracy with all bullet types. Fits all standard ½" x 28TPI AR style threaded barrels.

TR-EGB - ERGO® Grip - Simply the most comfortable and user friendly grip available for the AR family of weapons. Ergonomically designed grip is comfortable and prevents user fatigue. Molder from advanced space age polymers, the ERGO® grip is extremely durable.

Phone: Order Desk (800) 955-4856
Technical Assistance (870) 545-3618

Fax: 24-Hour Service (870) 545-3310

Internet Catalog: <http://www.wilsoncombat.com>

E-Mail: info2@wilsoncombat.com

Mail: Wilson Combat®
ScattergunTechnologies™
2234 CR 719
Berryville, AR 72616-4573

Our knowledgeable Customer Satisfaction Representatives are available weekdays from 8:00 a.m. - 5:30 p.m. (Central/Standard Time). If you would like to place an order outside of our normal business hours, we have a 24 HR Fax which will take your order. Or if you know your salesperson's extension, you may leave the order in the voice mailbox or in the general mailbox. When placing an order by mail, voicemail or Fax, please remember to provide the following information:

- 1) Full Name
- 2) Shipping Address including Zip Code
- 3) Quantity, Model Number and Description of item desired.
- 4) Payment Method - Note: When paying by credit card, please remember expiration date.
- 5) Phone Number (Daytime)

NO MINIMUM ORDER

SPECIAL ORDERS - All non-stock, special order items will require a 20% non-refundable deposit before item is ordered. No refunds will be available on special order products unless the item is deemed defective. Thank you!

BACK ORDERS - Due to the unanticipated popularity of certain items, we may be temporarily out of stock on certain items which we will back order. Unless requested otherwise, we will automatically ship all back ordered items that become available within thirty days. We will call you prior to shipping any item that has been on back order for more than thirty days.

DAMAGED GOODS - If you receive goods that have been damaged during shipment, save the package and contents, then contact the shipper immediately to file a claim. Failure to follow these instructions may void your claim for damages.

PAYMENT METHOD -

- 1) Credit Card - we accept VISA, MasterCard, and Discover.
- 2) Money Order - Certified Check - Cash
- 3) Company or Personal Check - shipment held 21 days allowing check to clear.
- 4) C.O.D. - All C.O.D. packages require cash or certified check payment unless check approval is granted prior to shipment. C.O.D. charge is \$9.00 per box plus any other shipping charges which may apply.

We prefer UPS shipment due to their efficient tracking and claims capabilities. However, we will ship by U.S. Mail upon request at customers' risk for loss or damages.

TECHNICAL QUESTIONS - If you require technical assistance pertaining to Wilson parts or custom pistol work, our technical staff will be happy to answer your questions. Simply call 1-870-545-3618 and ask for a Customer Satisfaction Representative between 8:00 a.m. and 5:30 p.m. (Central/Standard Time).

DISCLAIMERS - Wilson's Gun Shop, Inc. expressly disclaims liability for incidental or consequential damages. As provided for below, we do not offer any written or implied warranty on our products and expressly disclaim any implied warranty of merchantability or fitness for any particular purpose.

As a condition of sale, any controversy or claim arising out of or relating to a sale by Wilson Combat® shall be filed only in the courts of the State of Arkansas for Carroll County or the United States District Court for the Western District of Arkansas, which shall have exclusive jurisdiction over any dispute, regardless of where the claim may arise. No claim shall be actionable unless commenced within one year from date of sale.

No parts sold by us are intended for installation except by a trained pistolsmith, and parts and firearms sold by us are only intended for factory specification standard velocity ammunition. Any verbal representations made by us related to installation, should be confirmed with your local pistolsmith to assure safe operation in your particular firearm.

NO WRITTEN WARRANTY - Due to the complexities of complying with the Federal warranty law, Wilson's Gun Shop, Inc. does not offer a written warranty. We continue to stand behind our products and services, and to care for our customers, but we cannot make guarantees or warranties of any kind. This general statement of policies and disclaimers is effective July 1, 1985, and no prior statements or promises shall be of any effect for transactions after July 1, 1985.

WWW.WILSONCOMBAT.COM

Your First Choice For
The Latest And Greatest From
Wilson Combat® / Scattergun Technologies™

Where You Can Find:
More Products
Specials
New Models
Technical Information
Shooting And Maintenance Tips
Expanded Model Information
Expanded Parts Information
FAQs



Sign-Up For Wilson Combat®'s

DownRange

E-Newsletter at
www.wilsoncombat.com

Features Include:

New Product Releases
Product Reviews
Shooting Tips
Maintenance Tips
Free Product Give-Aways
Close-Out Specials

800-955-4856

Wilson Combat®
2234 CR 719
BERRYVILLE, AR
72616-4573

PRSRRT STD
US POSTAGE PD
PRINT GROUP, INC