

Milestones and Pioneering Achievements

100 years of Carl Zeiss riflescopes



1289.989 Printed in Germany www.sportive.net KD-12.03 Printed on environment friendly paper, bleached without the use of chlorine



Carl Zeiss
Sports Optics

Gloelstrasse 3-5
D-35576 Wetzlar
www.zeiss.de/sportsoptics



We make it visible.

100 Years of Carl Zeiss riflescopes 1904 - 2004 Milestones and Pioneering Achievements

- 1904** The ZEISS prism rifle scope for hunting, Model I. (M=2x, FoV=21.8/100 m, ER=30 mm) is introduced.
- 1909** Introduction of the ZEISS prism models Telekipp (for tip-up rifles) and Teleweit (for repeater rifles) with extended eye relief (M=2x, FoV=21.8/100 m, ER=70 mm).
- 1920** First Carl Zeiss lens riflescopes introduced: Zielvier (M=4x, FoV=10.8/100 m, ER=80 mm) and Zielsechs (M=6x, FoV=7/100 m, ER=80 mm).
- 1921** First riflescopes for hunting with adjustable power: ZEISS Zieldovier (M=1+4x, FoV=22.4+6.3/100 m, ER=80 mm) and ZEISS Zieldosechs (M=1+6x, FoV=22.4+4.2/100m, ER=80 mm).
- 1922** First riflescopes with continuously variable power: ZEISS Zielmulti (M=1-4x, FoV=22.4-6.5/100 m, ER=80 mm) and ZEISS Zielmultart (M=1-6x, FoV=20.6-72/100 m, ER=80 mm). First rifle scope with high magnification and highest twilight performance: ZEISS Zielacht (M=8/x, FoV=5.4/100 m, ER=80 mm).
- 1936** ZEISS "Federleicht" models 4x31 (285 g) and 6x42 (360 g), made for the first time out of a sturdy, light metal alloy with a prismatic mounting rail.
- 1937** First rifle scope with expanded field of view for shooting at running game: ZEISS Zielmar 1.5x14. Field of view 20 m at 100 m.
- 1942** ZEISS riflescopes delivered with ZEISS T single coating.
- 1966** Carl Zeiss introduces a rifle scope with adjustable power for drive-hunting: Diatal 2x16+4x32 (FoV=20/100 m+10/100 m, ER=80 mm).
- 1976** ZEISS rifle scope model Z/ZA with centered reticle introduced.
- 1979** All ZEISS riflescopes now delivered with ZEISS T* multi-coating.
- 1982** Carl Zeiss presents the first compact and light models Diatal-C 4x32, 6x32, 10x36, and the Diavari-C 1.5-4, 5x18, 3-9x36. The latter has a non-magnifying reticle lying in the ocular image plane. All C models have a 90 mm eye relief.
- 1990** ZEISS ZM/Z riflescopes introduced. All ZM models equipped with patented ZEISS internal slots for easy mounting. All tubes are made of single-piece, drawn aluminum and deliver unparalleled stability. The Diatal ZM/Z models contain a cardanic, spring-loaded joint as suspension for the erecting system.
- 1994** The ZEISS Diavari ZM/Z 3-12x56 now also available with illuminated reticle.
- 1998** The new ZEISS Victory riflescopes VM/V 1.5-6x42, 3-9x42, 2,5-10x50, 3-12x56, and 5-15x42 are significantly lighter (up to 30%), shorter and offer larger fields of view (up to 35%) and longer eye relief (up to 12%) compared to previous models. For the first time, a drive-hunting rifle scope with variable power and constant illuminated dot reticle is available – the ZEISS Varipoint VM/V 1.1-4x24, an ingenious invention. It offers superior fields of view between 36-10 m at 100 m and 90 mm eye relief.
- 2000** The ZEISS Varipoint 1.5-6x42, an all-purpose rifle scope with constant illumination dot reticle, with optional adjustable posts, is introduced. This new type of rifle scope is suitable not only for drive hunting, but also for stalking and sitting game. For the first time, the intensity of the dot can be adjusted from very bright (daylight setting) to very faint (low-light setting) without glare – practically a "day and night" illuminated reticle.
- 2001** ZEISS Conquest riflescopes 3-9x40 MC, 3.5-10x44 MC, and 4.5-14x44 MC, developed first and foremost for American hunting conditions, are introduced. Powerful, light, compact with peak transmission values in transmission and top quality – all at an attractive price. It is the result of Carl Zeiss' global production network. An increase in twilight performance was achieved with the Varipoint model 2.5-10x50.
- 2003** The pinnacle of the Varipoint line is introduced with performance data of 3-12x56. Carl Zeiss offers a targeting optic for precision shooting over large distances in the form of the Diavari V 6-24x56, a tele-rifle scope with high, light-gathering power. This model is also available with an illuminated reticle – exclusive in this class.



Zeiss accuracy, quality and durability have just come into your range.

CONQUEST riflescopes



CONQUEST riflescopes

For generations, sportsmen have set their sights on Zeiss' legendary engineering. Now it's within reach. Because now with engineering and state-of-the-art optical design exclusively for American

sportsmen, you get the accuracy, precision, durability and quality that you expect from Zeiss, for hundreds of dollars less than you'd expect to pay.

CONQUEST 3-9x40 MC

If you own just one riflescope, this versatile scope is the one to own.

Also available in a shotgun version engineered for shotguns, airguns and muzzle loaders.



- Magnification range for every type of hunting
- Larger, 40 mm objective
- Zeiss' proprietary MC fully multi-coated lenses
- 64" Windage/Elevation range - widest in its class
- Constant 4" eye relief throughout magnification range for safety and precision
- Lifetime Transferable Warranty

CONQUEST 3.5-10x44 MC

More power, with a larger, 44 mm objective



- 66" Windage/Elevation range - widest in its class
- Biggest field of view (35'-11.6' @ 100 yards) in its class
- Constant 3.5" eye relief throughout magnification range for safety and precision
- Lifetime Transferable Warranty

CONQUEST 4.5-14x44 AO MC

44 mm objective is the largest available that does not require raised mounts on your rifle.



- Turret-mounted adjustable parallax for long-range shooting
- Offers wider fields of view and higher light transmission than most riflescopes with larger objectives
- The turret adjusts, not the objective. So your eye never has to leave the target
- Constant 3.5" eye relief throughout magnification range for safety and precision
- Lifetime Transferable Warranty

CONQUEST 6.5-20x50 AO MC

Developed with the American long-range shooter in mind



- Turret-mounted adjustable parallax for long-range shooting
- Offers maximum field of view and higher light transmission than other riflescopes in its class
- 21 ounce weight makes it one of the lightest in its class
- Constant 3.5" eye relief throughout magnification range for safety and precision
- Lifetime Transferable Warranty

CONQUEST 3-9x40 MC,
3.5-10x44 MC,
4.5-14x44 AO MC, and
6.5-20x50 AO MC
also available in
stainless steel finish



Carl Zeiss Sports Optics

The first mid-price scopes built tough enough to earn the Zeiss Mark of Quality and come with a Lifetime Transferable Warranty.

While other mid-price scopes often use multi-piece tubes and painted surfaces, all Zeiss riflescopes are built to last a lifetime, with one-piece construction and hard anodized surfaces.

What's inside a Zeiss CONQUEST scope is even more impressive: Lead/arsenic free glass and Zeiss' proprietary reticles and coatings, to ensure lower stray light, higher light transmission and a lifetime of reliability.

Only the highest quality materials, constructed to ISO 9022 standard, to keep the quality in and fog and water out - even with the turret caps off.

Zeiss CONQUEST riflescopes are built to keep you on target year after year after year. Because about the only thing they have in common with other mid-price scopes is the price.

So fast, you may even get a second chance.
So accurate, you shouldn't need one.

With a Zeiss CONQUEST riflescope, you adjust windage and elevation with a finger's touch. And without wasting time fishing for a coin or tool. With Zeiss' quick focus, you make split-second field adjustments. And your range of windage and elevation adjustments is among the highest and widest in the industry, to fit a wider choice of calibers, loads and distances. All-new Zeiss optical design, proprietary Zeiss anti-reflective

coatings, and unparalleled precision give you unsurpassed clarity, low-light performance, field of view and depth of field. And mechanical erector design unique to this price class reduces stray light. So when you see your target, you really see it. Even better - and safer - you don't have to keep lining up shots over and over again; now matter how you set, and reset, the magnification, the eye relief remains constant.

Specifications	3-9x40	3.5-10x44	4.5-14x44	6.5-20x50
Magnification	3-9x	3.5-10x	4.5-14x	6.5-20x
Objective (mm)	40	44	44	50
Tube diameter (inches)	1	1	1	1
Field of View (ft @ 100 yds)	11.01'-34'	11.61'-35.1'	8.31'-24.99'	17.6'-5.8'
Parallax (yards)	100	100	30-infinity	50 - Infinity
	50 Shotgun version			
Reticle Image Plane (Magnifying)	2nd (no)	2nd (no)	2nd (no)	2nd (no)
Exit Pupil (mm)	13.3-4.4	12.57-4.4	9.7-3.14	7.7 - 2.5
Eye Relief (inches)	4	3.5	3.5	3.5
Length (inches)	13.15	12.7	13.86	15.6
Weight (ounces)	15	15.8	17.5	21
MOA	1/4	1/4 (optional 1/8)	1/4 (optional 1/8)	1/4 (optional 1/8)
Windage/Elevation Adj (inches)	64	66	43	45
Diopter Adj	+2/-3	+2/-3	+2/-3	+2/-3

More reticles, for more diverse shooting needs.

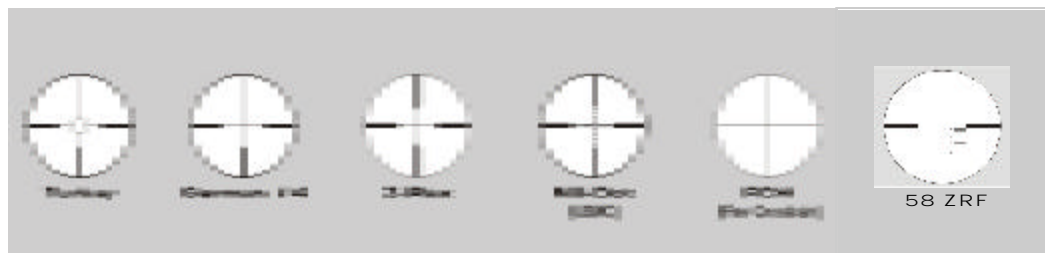

Carl Zeiss Optical, Inc. 13005 N. Kingston Avenue Chester, VA 23836

1-800-441-3005

www.zeiss.com

CONQUEST1 (5/02)

Overview of technical data:

	Conquest 50					
	3-9 x 50 MC		3.5-10 x 50 MC		4.5-14 x 50 AO MC	
Magnification	3	9	3.5	10.5	4.5	14
Effective objective diameter (mm)	34.2	50	40	50	48.6	50
Field of view (m/100 m (ft./100 yds.))	12.5 37.5	4.3 12.9	11.7 35.1	3.9 11.7	8.5 25.5	2.8 8.4
Twilight performance	8.5	21.2	9.9	22.9	12.7	26.5
Exit pupil (mm)	11.4	5.6	11.4	4.8	10.8	3.6
Diopter adjustment range (dpt)	+2/-3		+2/-3		+2/-3	
Eye relief (mm (inch))	89 3.5		89 3.5		89 3.5	
Parallax-free (m (yds.))		91.4 100		91.4 100		27.4-∞ 30-infinite
Square adjustment path (cm/100 m (inch/100 yds.))		208 74.88		183 65.88		H: 189/S: 125 H: 68.04/S: 45
Adjustment per click (cm/100 m (MOA))		0.7 1/4		0.7 1/4		0.7 1/4
Centre tube diameter (mm (inch))		25.4 1		25.4 1		25.4 1
Objective tube diameter (mm)		56		56		56
Eyepiece tube diameter (mm)		41		41		41
Length (mm (inch))		314 12.36		334 13.15		356 14.02
Weight (g (oz.))		470 16.58		485 17.11		560 19.75
Order reference black	52 14 80		52 14 85		52 14 90	
Order reference stainless	52 14 84		52 14 89		52 14 94	

MC = Multi-coating AO = with parallax adjustment H = height S = at side

Reticles for Conquest models:

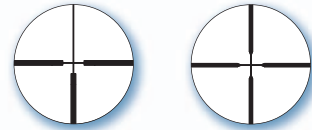

Reticle 4

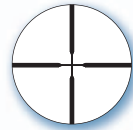

Reticle 20 (Z-Plex)

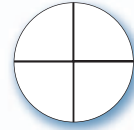

Reticle 21

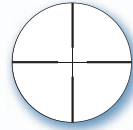

Reticle 43 (Mil-Dot)

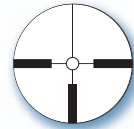

Reticle 57 (Turkey)

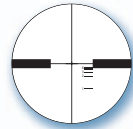

Reticle 58 (Ranging)

Available reticles

	Reticles					
	4	20	21	43	57	58
3-9 x 50 MC	•	•	•	•	•	•
3.5-10 x 50 MC	•	•	•	•	•	•
4.5-14 x 50 AO MC	•	•	•	•	•	•

Conquest 50 MC - extra models. Extra performance.



Carl Zeiss Sports Optics

Gloelstr. 3-5
D - 35576 Wetzlar
www.zeiss.de/sportsoptics

1398 071 Printed in Germany till 03/2004. www.zeiss.us.net
Printed on environment-friendly paper, bleached without the use of chlorine.



Conquest 50 MC



We make it visible.

Extra twilight reserves: The new Conquest 50 MC.



The sequel to a success story: initially designed especially for the US American market, the Conquest series has now been extended by three new models that will soon also be in great demand in Europe.

Due to a large objective lens diameter of 50 mm, all three new products are extremely light-sensitive. The MC multi-coating on all glass-air surfaces furthermore ensures maximum light penetration values. Maximum transmission levels

are hereby provided in the relevant spectral range so that optimum twilight performance is achieved.

The further performance characteristics of the new Conquest 50 riflescopes are equally impressive: long eye relief, large fields of view and above-average stability designate these waterproof, nitrogen-filled models as top accessories for ambitious huntsmen or sports marksmen.

The light-sensitive all-rounder. Conquest 3.5-10 x 50 MC



This powerful universal riflescope with a higher magnification range equally impresses with its high degree of light-sensitivity, predestining it for twilight implementation. Providing brilliant image quality, the Conquest 3.5-10 x 50 MC offers a wide field of view of 11.7 to 3.9 m at 100 m (35.1-11.7 ft. at 100 yds.).

The modern classic. Conquest 3-9 x 50 MC



The classic magnification range – now with a 50 mm objective lens. The Conquest 3-9x50 MC is a comparatively lightweight, handy riflescope with a large field of view for universal implementation that supplies bright, brilliant images even in unfavourable light conditions. Like all three new Conquest models, it features a large reticle adjustment range.



The far-sighted perfectionist. Conquest 4.5-14 x 50 AO MC

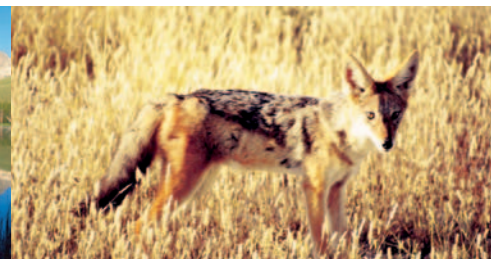

This high-performance model was developed for sports marksmanship at long distances. For that reason this riflescope features parallax adjustment and may thus be focused to very short or long distances even at maximum magnification. The Conquest 4.5-14 x 50 AO MC features an extended reticle elevation adjustment range and swift reticle adjustment for precise, uncomplicated shooting at varying distances.



Successful hunting depends on performance: riflescopes from Carl Zeiss.



We make it visible.

Hunting and wildlife conservation – the same idea is behind both.



The hunter's prime task is to manage the game and preserve the ecological balance.



Hunting represents a major contribution by man to the preservation of the ecological equilibrium. Were it not for the many tasks that the hunter performs throughout the year to preserve and maintain biotopes, healthy stocks of game and diversity of species would no longer be conceivable. Game management by rifle plays an absolutely crucial role in this.

Under sometimes extreme conditions, after the hunter has put a huge effort into stalking or waiting, now at immense distances, now on the narrowest of aisles, the actual hunt is often condensed to a single brief moment. At this moment, it is the quality of the riflescope, in particular, that determines the success of the hunt.

The tradition of correct hunting and the hunter's responsibility towards the game place him under a constant obligation to achieve the perfect equipment. This applies to his weapon, his binoculars and, in particular, his riflescope.



Contents:	Page
Diavari VM/V 1.5 – 6 x 42 T* _____	05
Diavari VM/V 2.5 – 10 x 50 T* _____	06
Diavari VM/V 3 – 12 x 56 T* _____	07
Diavari VM/V 3 – 9 x 42 T* _____	08
Diavari VM/V 5 – 15 x 42 T* _____	09
Diavari V 6 – 24 x 56 T* _____	10
Varipoint VM/V 1.1 – 4 x 24 T* _____	15
Varipoint VM/V 1.5 – 6 x 42 T* _____	16
Varipoint VM/V 2.5 – 10 x 50 T* _____	17
Varipoint VM/V 3 – 12 x 56 T* _____	18
Conquest 3 – 9 x 40 MC _____	27
Conquest 3.5 – 10 x 44 MC _____	28
Conquest 4.5 – 14 x 44 MC _____	29
Conquest 6.5 – 20 x 50 MC _____	30

The Zeiss line of riflescopes

Not only the choice of weapon and caliber, but also the choice of riflescope helps to decide whether you will make a clean kill. The Zeiss line of riflescopes offers a wide selection designed in practical graduated steps to suit every hunter's need.

Whether you want a riflescope for sitting game, general-purpose use or rapid fire on a drive hunt, Carl Zeiss offers instruments of the highest quality for your individual hunting needs. In addition to the great variety of power ranges you can also choose between models with reticles in the 1st image plane (size changes with the magnification) and those with reticles in the 2nd image plane (size of reticle remains constant).

Diavari models are available with illuminated dot or cross-hair reticles for twilight vision.

The Varipoint line offers a continuously adjustable non-magnifying illuminated dot that can be used in both low-light conditions and broad daylight.

The Conquest line comes with the common standard reticles as well as special reticles for estimating distance.

Diavari VM/V – top-class models with the Advanced Optics System. Key features are their outstanding optical quality, very wide fields of view, large eye relief, light weight and compactness. Every model is available either with the patented rail slot (VM) or without (V)¹⁾.

Varipoint VM/V – further developments of the Diavari line. Besides excellent optical and mechanical quality, these riflescopes feature a red illuminated dot that can be used not only at twilight but also for taking quick shots by day, which makes it superior to the Diavari illuminated reticle. The Varipoint simply allows you to shoot accurately faster.

Conquest – primarily designed for the American market. Powerful, light, compact and of the finest quality: ideal for hunting and sport.

¹⁾ Diavari V 6 – 24 x 56 T* only available without a rail slot.



Diavari VM/V – lightweight, compact, powerful.

Carl Zeiss has hit the bull's eye with the Diavari series – a further milestone in almost 100 years of riflescope construction at Carl Zeiss.

Maximum transmission, sharp contrast and excellent brilliance describe the image quality of the Diavari VM/V models. These riflescopes are also extremely lightweight and compact for their category, and extremely robust. The Diavari models also display the best possible performance with regard to eye relief and field of view. They owe these superb features to the Zeiss Advanced Optics System (AOS), a revolutionary optical design in conjunction with modern, thin, arsenic- and lead-free glass.

The patented T* multicoating gives the riflescopes a light transmission of more than 90%, and the increase in transmission in the blue spectral range ensures superb performance, especially at twilight. The nitrogen filling prevents the lenses from fogging on the inside and also guarantees a very high degree of reliability under extreme weather conditions.

Pioneering quality and optical performance:

- Very high twilight performance, increased transmission in the blue spectral range thanks to T* multicoating.
- Optimum contrast at the limit of the human eye's resolution.
- Minimized share of ghost images even when facing the light.
- Extremely wide fields of view.
- Large eye relief, mounting option of up to 95 mm (3.74 in.) eye relief for particular safety.
- With the Advanced Optics System (AOS) for enormous optical performance and sturdiness with minimal weight and short overall length.
- Perfect sealing, no penetration of dust or moisture.
- No exchange with the surrounding atmosphere, environmentally tested in accordance with ISO 9022-80.
- Absolutely recoil-proof, tested to 1500 G/1 msec in the fatigue test, which corresponds to the stress caused by the most powerful hunting caliber.
- Unique, patented Zeiss mounting rail, simple mounting and high value retention¹⁾.
- All models also available with bullet drop compensator.
- Easy, precise sighting-in using zeroable reticle adjustment and accurate, wear-resistant clickstop mechanism.

¹⁾ Diavari V 6–24 x 56 T* only available without a rail slot.

The lightweight with the wide field of view.

Diavari VM/V 1.5 - 6 x 42 T*



Diavari VM/V 1.5 - 6 x 42 T.
The versatile riflescope for hunting by day.*

The Diavari VM/V 1.5 - 6 x 42 T* is an all-round riflescope, a reliable companion on any daytime hunt. The field of view of 24 m/100 m (72 ft./100 yds.) is perfectly sized, the largest in its performance category, an advantage that comes into its own when snap shooting at low magnifications. With its low mount it is also ideal for all tip-up weapons. And with an eye relief of 90 mm (3.54 in.) it offers adequate safety even with the most powerful calibers.

At the same time, its compact dimensions and minimal weight make it the lightest riflescope in its category. This is a noticeable advantage that makes the weapon easier to handle and fits in with the trend towards light hunting equipment.



The compact all-round riflescope.

Diavari VM/V 2.5 - 10 x 50 T*



The Diavari VM/V 2.5-10 x 50 T is available with or without an illuminated reticle.*



With an objective lens diameter of 50 mm, the Diavari VM/V 2.5 – 10 x 50 T* is a very powerful riflescope. It also performs impressively when used for sitting game by night.

The sensational field of view of 14.5 m at 100 m (43.5 ft. at 100 yds.) at a magnification of 2.5x offers enormous advantages for shooting rapidly at short distances. It is particularly light, extremely compact and especially safe as a result of the large eye relief. Thanks to the nitrogen filling this instrument, like all Zeiss riflescopes, remains fog-free even when exposed to extreme fluctuations in temperature. All these features make the Diavari 2.5 – 10 x 50 T* one of the most powerful all-round riflescopes.



The No.1 in its performance category.

Diavari VM/V 3 - 12 x 56 T*



The Diavari VM/V 3 - 12 x 56 T
is available with or without an illuminated reticle.*

Only superlatives can describe the Diavari VM/V 3 - 12 x 56 T*. The short overall length and light weight are unique in its performance category.

This riflescope is ideal for a huge variety of hunting occasions. Thanks to its superb twilight performance it is the perfect riflescope for hunting until the very last adequate light finally fades.

If this riflescope is fitted with an illuminated reticle it is also possible to see the illuminated dot or crosshair clearly against the body of the game in very low light conditions.



Unsurpassed in high mountains.

Diavari VM/V 3 - 9 x 42 T*



Diavari 3 - 9 x 42 T. The lightweight for the mountains, particularly slimline and compact.*

The very powerful and compact Diavari VM/V 3 - 9 x 42 T* is the ideal riflescope for hunting in high mountains. The large objective lens diameter is an additional advantage when the weather is bad and the light poor. The reticle in the second image plane is easily visible at low magnifications for shooting rapidly and ideal at high magnifications for shooting accurately at long range.

With an eye relief of 90 mm (3.54 in.) the Diavari VM/V 3 - 9 x 42 T* also offers adequate safety when using powerful calibers. The reticle adjustment (one click = 0.7 cm/at 100 m = 1/4 MOA) makes sighting-in easier. Weighing in at a mere 435 grams (15.34 oz.), this riflescope is a real lightweight, which is particularly advantageous on long stalks in inhospitable terrain.



In control at long range.

Diavari VM/V 5 - 15 x 42 T*



Diavari VM/V 5 - 15 x 42 T.*

The perfect riflescope for long range or target shooting.

The Diavari VM/V 5-15 x 42 T* is a riflescope with a high power range, ideal for shooting at great distances. The objective lens diameter of 42 mm offers very good light reserves.

The field of view of 7.9 m/100 m (23.7 ft./ 100 yds.) at a magnification of 5x is well above the average for similar riflescopes. The Diavari VM/V 5-15 x 42 T* can be sighted in very precisely due to the reticle adjustment (0.7 cm per click at 100 m = 1/4 MOA). The reticle in the 2nd image plane conceals little of the body of the game.



The riflescope for very long range.

Diavari V 6 - 24 x 56 T*



The Diavari 6 - 24 x 56 T is also available with an illuminated reticle.*

The latest arrival in the Diavari line is a riflescope for specialists, for target shooting and hunting varmint at long range. Its very high magnifications are also a particular advantage to experienced hunters in steppe and mountain country.

30 mm (1.18 in.) center tube for ring mounting. A remarkable feature in this category is the large objective lens diameter of 56 mm, which offers a clear and brilliant image even in poor light.

With the reticle in the second image plane its size always remains constant. Therefore, at high magnifications little of the target is concealed, which is an advantage when sighting small targets at great distances. The large adjustment range for the reticle of up to 160 cm at 100 m (57.6 in. at 100 yds.) makes sighting-in at long range easier. The Diavari 6 - 24 x 56 T* is fitted with a bullet drop compensator as standard. It is also available with the Mil-Dot reticle and the Target-Dot reticle.





Change without wear and tear.

The patented rail slot

Experts consider the best riflescope mounting system in the world to be the patented Zeiss rail slot.

Diavari VM/V and Varipoint VM/V riflescopes are available either without (V models) or with a rail slot (VM models).

The Zeiss rail slot is a superb solution: A hollow rail slot runs along the lower part of the one-piece tube body.

The mounting elements are secured in this slot, entirely recoil-proof and invisible. The riflescope can be mounted and removed without leaving any marks. And the position of the riflescope on the weapon (eye relief) can be adjusted to suit any shooter in a matter of minutes without any machining. The illustration shows the cross-section of a Zeiss VM riflescope with integrated mounting rail on a modern pivot mount. The engagement of one of the three mounting elements in the slot is clearly visible.

All the advantages at a glance

- Entirely stress-free mount, no dents on the riflescope due to unprofessional ring mounting.
- No roughening for cementing the rings, no ring or cementing marks when the eye relief is changed.
- No machining of the riflescope (milling, filing, drilling etc.).
- Even after being switched to a different barrel or weapon, the riflescope retains its original non-machined condition and therefore preserves maximum value.
- Particularly good-looking mount in conjunction with modern riflescope mounting systems.



The cross-section of a VM series tube shows the impressive thickness of the wall and the patented Zeiss rail slot: experts consider this to be the best riflescope mounting system in the world.

Reticles for riflescopes in the Diavari VM/V line.

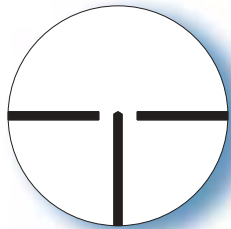

Reticle 1

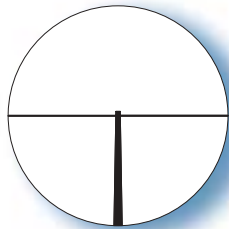

Reticle 2

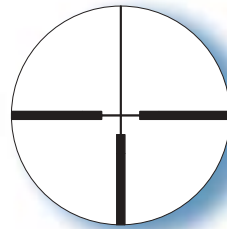

Reticle 4

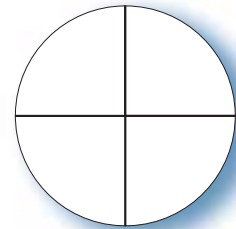

Reticle 6

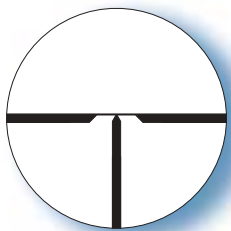

Reticle 7

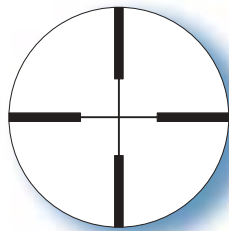

Reticle 8

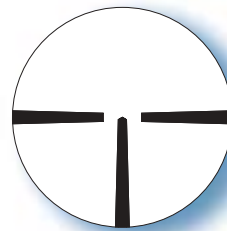

Reticle 11

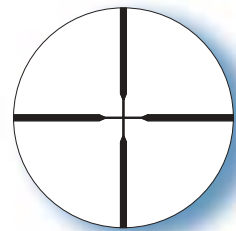

Reticle 20

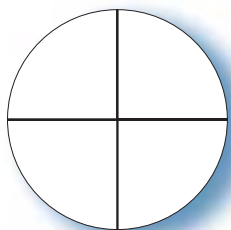

Reticle 21

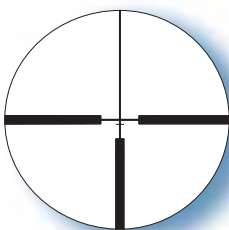

Reticle 42

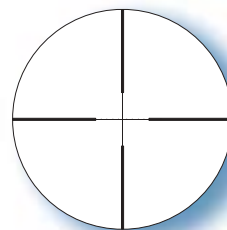

Reticle 43
(Mil-Dot)

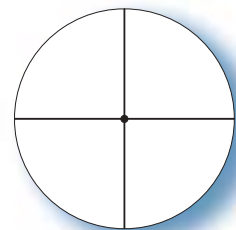

Reticle 61
(Target-Dot)

Available reticles

- Diavari VM/V 1.5 - 6 x 42 T***
- Diavari VM/V 2.5 - 10 x 50 T***
- Diavari VM/V 3 - 12 x 56 T***
- Diavari VM/V 3 - 9 x 42 T***
- Diavari VM/V 5 - 15 x 42 T***
- Diavari V 6 - 24 x 56 T***

Image plane	Reticle											
	1	2	4	6	7	8	11	20	21	42	43	61
1	●		●	●	●	●	●					
1	●		●	●	●	●	●			●		
1	●		●	●	●	●	●				●	
2		●	●		●		●	●	●			
2		●	●		●		●	●	●			
2			●								●	●

Illuminated reticles for riflescopes in the Diavari VM/V line.

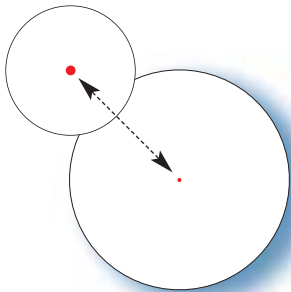

Reticle 0

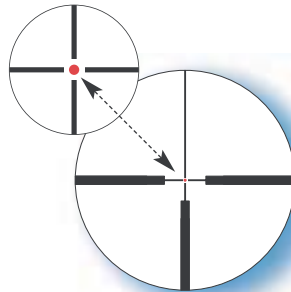

Reticle 40

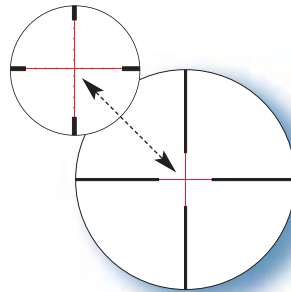

Reticle 43

(only 3-12x56 T* and 6-24x56 T*)

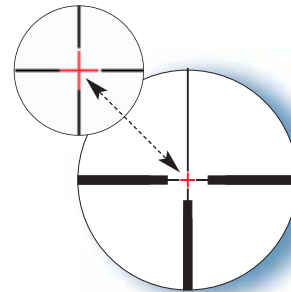

Reticle 44

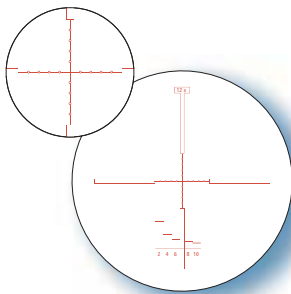

Reticle 63

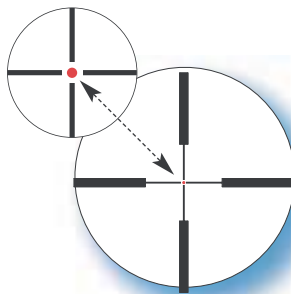

Reticle 80

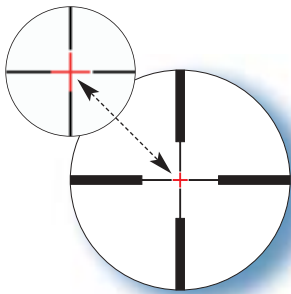

Reticle 88

In low-light conditions or by moonlight an illuminated reticle is, of course, much easier to make out on the dark body of an animal than black posts. Both the Diavari VM/V models, the 2.5-10 x 50 T* and the 3-12 x 56 T*, are available with the illuminated reticles 0, 40, 44, 80 and 88, and the 3-12 x 56 T* is also available with 43 "Mil-Dot". The Diavari 6-24 x 56 T* is available with the illuminated reticles 40 and 43 "Mil-Dot". The above models can also be retrofitted with these illuminated reticles by the manufacturer.

It is important to be able to adjust the intensity of the illumination of the reticle very finely to suit the light conditions (starting from very poor) in order to prevent glare.

Available illuminated reticles

Diavari VM/V 2.5 - 10 x 50 T*

Diavari VM/V 3 - 12 x 56 T*

Diavari V 6 - 24 x 56 T*

Image plane	Illuminated reticle for twilight					
	0	40	43	44	80	88
1	●	●		●	●	●
1	●	●	●	●	●	●
2		●	●			



Varipoint VM/V - innovation in optical systems.

Realized for the first time by Carl Zeiss: the combination of an illuminated dot sight and a high-quality riflescope with variable image magnification.

The Varipoint models have been developed from the Diavari series and have proven their value superbly as a practical innovation that enables you to aim even more quickly and shoot accurately. Even at running game on narrow aisles as well as at a head of game that is standing and gazing at a greater distance – in glistening sunlight and deep twilight. This is because the illuminated dot of the Varipoint riflescopes lies in the second image plane, which means that it is non-magnifying and enables the same concentration on dot and target at any magnification. This is the outstanding advantage of this modern riflescope principle.

Three reticles are available to choose from: 0, 54 and 56. The intensity of the red illuminated dot is continuously adjustable and adaptable to a very wide variety of light conditions – with high contrast and no glare. Unlike conventional illuminated dot sights, the Zeiss Varipoint offers the advantage that you can also aim using the dot without any illumination, in which case the dot appears black.

Ultra modern optical systems of proven quality:

In terms of optics and mechanics the Varipoint models are based on the Diavari series. They offer the following: maximum transmission thanks to the Advanced Optics System, wide fields of view with minimal weight and short overall length as well as all the other advantages of the Diavari riflescopes – see info box on Page 4.

- There are 4 models to choose from to suit a variety of hunting needs.
- 3 different illuminated reticles for “Day & Night”, with strong luminous intensity for hunting in broad daylight and a continuously adjustable dimmer facility for sitting game in low-light conditions.
- The illuminated dot in the 2nd image plane is easily visible not only at short distances and low magnifications but also at high magnifications and long distances, as it conceals little of the target.
- Precise sighting-in, e.g., on DJV A2 pattern.

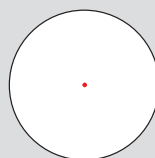

*Reticle 0
illuminated*

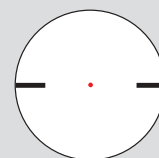

*Reticle 54
Magnification of 6 x
illuminated*

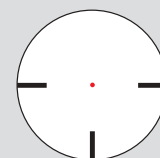

*Reticle 56
Magnification of 6 x
illuminated*

High-tech for the drive hunt.

Varipoint VM/V 1.1 - 4 x 24 T*



The Varipoint 1.1-4 x 24 T, a premium drive-hunt riflescope – with a powerful illuminated dot for use by day.*

With this high-tech riflescope, Carl Zeiss has succeeded in creating a truly wonderful innovation, specifically designed for a drive hunt. Extremely light and easy to handle, the Varipoint VM/V 1.1-4 x 24 T* with 36 m/100 m (108 ft./100 yds.) currently has the widest field of view of all drive-hunt riflescopes. The reticle shows only a dot in the center, with no posts or lines, making it ideal for shooting rapidly. If the light conditions are unfavorable or the background is dark you can switch on the adjustable illumination to make this dot turn red – with high contrast and no glare.

But even in extreme light conditions, such as intense sunlight in snow-covered terrain, the red dot is clearly visible. Unlike the usual illuminated dot sights, the Zeiss Varipoint offers the advantage that you can also aim without any illumination, i.e. using the black dot – this is very useful if, say, your battery should happen to fail while you are on a drive hunt.

At a magnification of 1.1 times this riflescope also allows you to shoot rapidly with both eyes open.

The editorial office of the DWJ, a German hunting and shooting magazine, awarded the successful combination of illuminated dot sight and drive-hunt riflescope the 1998 innovation prize.

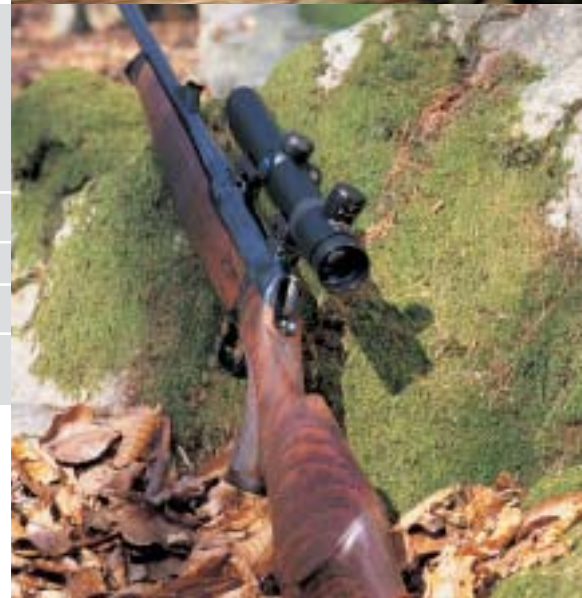

Coverage of reticle O on the Varipoint VM/V 1.1 - 4 x 24 T*

	25 m	50 m	100 m	200 m
Magnification of 1.1	5.0 cm	10.0 cm	20.0 cm	40.0 cm
Magnification of 2.0	2.8 cm	5.5 cm	11.0 cm	22.0 cm
Magnification of 4.0	1.4 cm	2.8 cm	5.5 cm	11.0 cm

The all-rounder for stalking, sitting game and drive hunts.

Varipoint VM/V 1.5 - 6 x 42 T*



Varipoint VM/V 1.5-6 x 42 T. The all-round riflescope with a wide field of view and an illuminated dot.*

The Varipoint 1.5-6 x 42 T* satisfies all the demands made on an all-round riflescope. If you were surprised by the performance of the Varipoint 1.1-4 x 24 T* as twilight sets in, then you will be amazed by the Varipoint 1.5-6 x 42 T*! The Varipoint 1.5-6 x 42 T* has an exit pupil of 7 mm at the highest magnification. This value matches the maximum size of the human pupil when fully open.

The finely dimmable illuminated dot is much richer in contrast and therefore easier to see than a non-illuminated reticle. At a magnification of 6 times the red dot covers only 3.7 cm (1.33 in.) of the body of the game at a distance of 100 m (100 yds.) or 7.4 cm (2.66 in.) at a distance of 200 m (200 yds.), thus making it possible to shoot very accurately at great distances.

On a drive hunt, i.e. at a magnification of 1.5 times, the red illuminated dot, with a 3.7 cm (1.33 in.)

coverage at 25 m (25 yds.), stands out clearly against the body of the animal. For hunters who want other reticle elements besides the black dot or red illuminated dot, Zeiss offers the reticles 54 and 56 for this model. These are suitable for estimating distance: these special reticles combine the dot reticle 0 in the second image plane with posts in the first image plane, another Zeiss innovation in riflescope construction. The distance between the two horizontal posts, which change in thickness in line with the magnification chosen, is always 1.40 m, i.e. twice as much as with reticles 1, 4 and 11 (Diavari reticles).



It has proved particularly useful to sight in the Varipoint 1.5-6 x 42 T on the DJV A2 pattern.*



Coverage of dot with reticles 0, 54 and 56 on the Varipoint VM/V 1.5 - 6 x 42 T*

	25 m	50 m	100 m	200 m
Magnification of 1.5	3.7 cm	7.4 cm	14.7 cm	29.4 cm
Magnification of 3.0	1.8 cm	3.7 cm	7.4 cm	14.7 cm
Magnification of 6.0	0.9 cm	1.8 cm	3.7 cm	7.4 cm

Setting your sights on excellence.

Varipoint VM/V 2.5 - 10 x 50 T*



Varipoint VM/V 2.5-10 x 50 T.
The powerful riflescope with versatile uses.*

This all-round, extremely powerful riflescope with its wide power range is ideal for drive hunting, stalking and sitting game at dawn and late dusk.

As with all models in this line, the red dot lies in the second image plane. This means that the size of the dot remains constant and it is visible with high brightness and contrast in daylight, enabling it to lead the eye. In low-light conditions it is dimmed to minimal luminous intensity in order to prevent glare.

The ten times magnification makes it possible to shoot accurately at great distances. And if you have to react quickly the wide exit pupil at low magnifications ensures that you do not lose sight of your target when you are taking aim.

Despite all these benefits, the Varipoint VM/V 2.5-10 x 50 T*, with an overall length of 327 mm (12.87 in.) and a weight of only 580 g (20.46 oz.) (with rail slot), is also compact and light.



Coverage of dot with reticles 0, 54 and 56 on the Varipoint VM/V 2.5 - 10 x 50 T*

	25 m	50 m	100 m	200 m
Magnification of 2.5	2.2 cm	4.4 cm	8.8 cm	17.6 cm
Magnification of 5.0	1.1 cm	2.2 cm	4.4 cm	8.8 cm
Magnification of 10.0	0.55 cm	1.1 cm	2.2 cm	4.4 cm

Top performance at twilight.

Varipoint VM/V 3 - 12 x 56 T*



Varipoint VM/V 3 - 12 x 56 T.
The all-round high-performance model for all types of hunting.*

The highest-performing model in the Varipoint line in the most popular power range 3 – 12 x 56 is a classic day and night riflescope: the red illuminated dot is dimmable in fine graduations and can therefore be used in any lighting, ranging from bright sunshine to very low light conditions, without any glare.

It lies in the second image plane and is consequently clearly visible even at low magnifications – a major advantage over the illuminated reticle of the Diavari models, e.g. when sitting game at the luring place.

At high magnifications a key feature of the illuminated dot is the small coverage (see table below), which makes it ideal for shooting accurately at long range.

This model is also therefore perfectly suited for target shooting. In good light the “static” disciplines of fox and deer are shot with a black dot (non-illuminated), and the running boar with the contrast-rich red dot (illuminated). The rings on the game targets and the shot holes are easy to make out at 12x magnification at a distance of 100 m. The Varipoint 3 – 12 x 56 T* therefore offers superb performance for both hunting and competitions.

Coverage of dot with reticles 0, 54 and 56 on the Varipoint VM/V 3 - 12 x 56 T*

	25 m	50 m	100 m	200 m
Magnification of 3.0	1.8 cm	3.7 cm	7.4 cm	14.7 cm
Magnification of 6.0	0.9 cm	1.8 cm	3.7 cm	7.4 cm
Magnification of 12.0	0.45 cm	0.9 cm	1.8 cm	3.6 cm



Varipoint reticles - their advantage is obvious.

The illuminated dot lies in the 2nd image plane and remains constant across the entire power range. This offers one crucial benefit: in relation to the image of the target, the dot is large enough at a low magnification for short shooting distances to allow the target to be covered quickly and accurately. At a

higher magnification it is small enough to enable the shot to be offered precisely even at greater distances. The horizontal posts of reticles 54 and 56 can be used to estimate distance. They lie in the 1st image plane. The aperture measures 1.40 m at a distance of 100 m.

Diagram illustrating the Varipoint reticles at various distances and magnifications:

Reticle 0 on the Varipoint VM/V 1.5 - 6 x 42 T*

Distance	25 m	50 m	100 m	200 m
Magnification				
$M = 1.5x$				
$M = 3x$				
$M = 6x$				

Reticle 54 on the Varipoint VM/V 1.5 - 6 x 42 T*

Distance	25 m	50 m	100 m	200 m
Magnification				
$M = 1.5x$				
$M = 3x$				
$M = 6x$				

Size of the field of view at a distance of 100 m – a comparison of the Varipoint models.

The table on the right shows the sizes of the fields of view on the four Varipoint models at various magnifications.

To ensure that you are optimally equipped for all hunting needs it is advisable to use two riflescopes alternately on a weapon: a light riflescope with low magnification and a particularly wide field of view (1.1 – 4 x 24 or 1.5 – 6 x 42) is ideal for drive hunting and stalking by day at medium and short distances.

For shooting at long range by day, sitting game at twilight or sitting wild boar at night, a second riflescope with a high magnification and a large objective lens diameter (2.5 – 10 x 50 or 3 – 12 x 56) is the right instrument.

Magnification	Fields of view on the Varipoint models			
	1.1-4 x 24	1.5-6 x 42	2.5-10 x 50	3-12 x 56
1.1	36.00 m			
1.5	32.45 m	24.0 m		
2.0	28.01 m	22.1 m		
2.5	23.57 m	20.2 m	14.5 m	
3.0	19.13 m	18.3 m	13.8 m	12.5 m
4.0	10.25 m	14.5 m	12.4 m	11.5 m
5.0		10.7 m	11.0 m	10.5 m
6.0		6.9 m	9.6 m	9.5 m
7.0			8.2 m	8.5 m
8.0			6.8 m	7.5 m
9.0			5.4 m	6.5 m
10.0			4.0 m	5.5 m
11.0				4.5 m
12.0				3.5 m

Illuminated reticles for Varipoint VM/V.

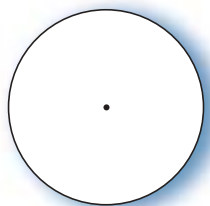

Reticle 0
non-illuminated

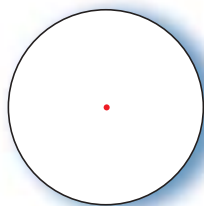

Reticle 0
illuminated

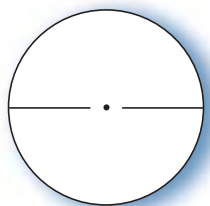

Reticle 54
Magnification of 1.5 x
non-illuminated

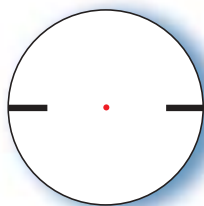

Reticle 54
Magnification of 6 x
illuminated

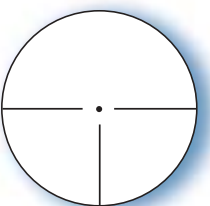

Reticle 56
Magnification of 1.5 x
non-illuminated

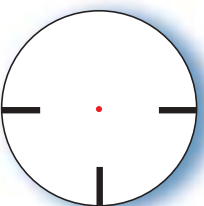

Reticle 56
Magnification of 6 x
illuminated

The reticle 0 for all Varipoint models with a black dot reticle and a powerful red illuminated dot – perfect for shooting rapidly and instinctively. The coverage of the dot varies according to the power selected. The individual coverage dimensions can be found in the tables on pages 13 – 16.

Reticles 54 and 56 combine reticle elements in the first and second image plane for the first time ever in a riflescope.

The illuminated dot reticle in the second image plane makes it possible to shoot accurately with little coverage at great distances and the powerful dot also makes the reticle good for shooting rapidly at short distances on a drive hunt.

The horizontal posts lie in the 1st image plane and change with the magnification. The distance between the two horizontal posts is always 1.40 m, which means that you can estimate the distance from the game.

Available illuminated reticles

Varipoint model	Image plane	Illuminated reticle for daytime and twilight		
		0	54	56
1.1 - 4 x 24 T*	2	●		
1.5 - 6 x 42 T*	1 (+2)	●	●	●
2.5 - 10 x 50 T*	1 (+2)	●	●	●
3 - 12 x 56 T*	1 (+2)	●	●	●

It takes next to no time to sight in.

With the zeroable reticle adjustment for Zeiss Diavari VM/V, Varipoint and Conquest riflescopes

All Zeiss Diavari VM/V, Varipoint and Conquest riflescopes (other than 6.5 – 20 x 50 MC and Diavari 6 – 24 x 56 T*) have a reticle adjustment with a zero position. This makes sighting-in with different loads much easier. And of particular importance is the fact that you can return to the zero position for a load for which you have already sighted in your riflescope in next to no time. The reticle adjustment is manufactured with high precision, ensuring one hundred percent repeatability. It is waterproof even with the elevation cap removed.

The highlight is the clickstop mechanism, which, depending on the riflescope model, is calibrated to 1 click $\hat{=}$ 1 cm at 100 m or 1 click $\hat{=}$ 1/4 MOA = 0.7 cm at 100 yards.



With the zeroable reticle adjustment, sighting-in becomes child's play.

► Note: Varipoint and Diavari VM/V riflescopes with the current reticle adjustment can be retrofitted for the new type at the Zeiss factory.





Aim for the bull's eye every time - at any distance.

With the bullet drop compensator

The bullet drop compensator (BDC) for Diavari VM/V, Varipoint and Conquest models allows you to aim dead center all the time, even at great distances. The Zeiss Service Department can install (or retrofit) a BDC ring in the elevation adjustment which is matched to the trajectory of the load you are using. With the BDC the trajectory of the bullet is compensated for so that you yourself do not have to compensate for the drop of the bullet, even at long range, by shooting high.

To shoot dead center at the desired distance of 100 m, 200 m, 250 m or 300 m all you have to do is turn the ring to the corresponding 1, 1.5, 2, 2.5 or 3 mark.



*Sighting in dead center:
adjusted to different
distances in seconds.*

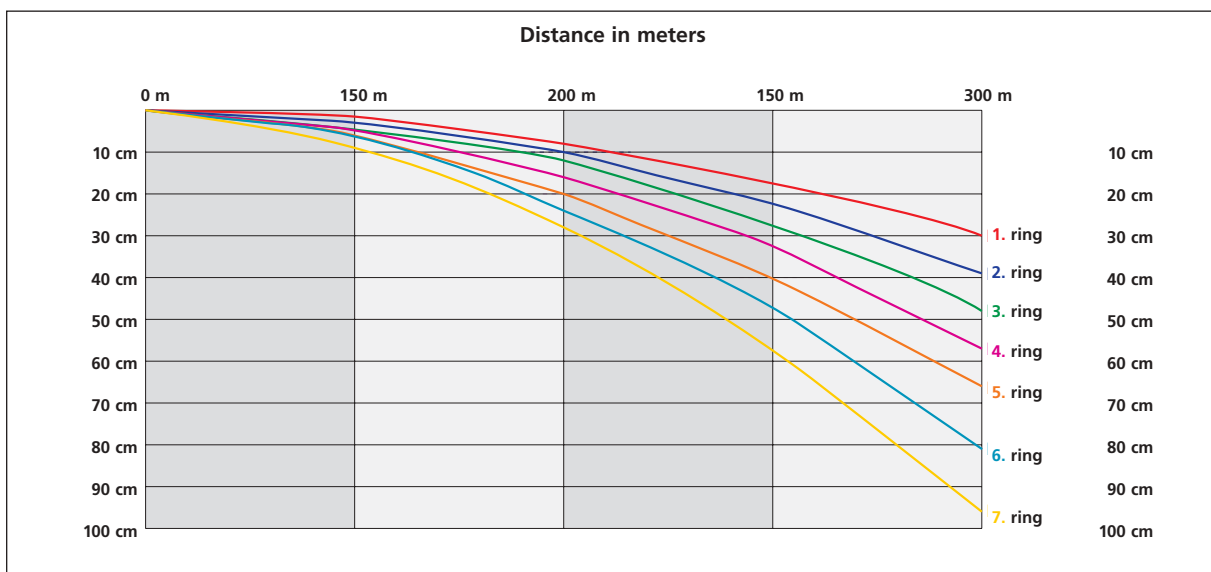

Trajectory compensation through the BDC rings 1–7 for riflescopes with 1 cm/100 m clickstop mechanism.



Overview of the effects of the seven BDC rings using riflescopes with 1.0 cm or 0.7 cm/100 m clickstop mechanism (sighting in dead center at 100 m).

Distance in m		100 m	150 m	200 m	250 m	300 m
1. ring Correction	Number of clicks	⊕	1	4	7	10
	1 click = 1 cm/100 m	⊕	1.50	8.00	17.50	30.00
	1 click = 0.7 cm/100 m	⊕	1.05	5.60	12.25	21.00
2. ring Correction	Number of clicks	⊕	2	5	9	13
	1 click = 1 cm/100 m	⊕	3.00	10.00	22.50	39.00
	1 click = 0.7 cm/100 m	⊕	2.10	7.00	15.75	27.30
3. ring Correction	Number of clicks	⊕	3	6	11	16
	1 click = 1 cm/100 m	⊕	4.50	12.00	27.50	48.00
	1 click = 0.7 cm/100 m	⊕	3.15	8.40	19.25	33.60
4. ring Correction	Number of clicks	⊕	3	8	13	19
	1 click = 1 cm/100 m	⊕	4.50	16.00	32.50	57.00
	1 click = 0.7 cm/100 m	⊕	3.15	11.20	22.75	39.90
5. ring Correction	Number of clicks	⊕	4	10	16	22
	1 click = 1 cm/100 m	⊕	6.00	20.00	40.00	66.00
	1 click = 0.7 cm/100 m	⊕	4.20	14.00	28.00	46.20
6. ring Correction	Number of clicks	⊕	4	12	19	27
	1 click = 1 cm/100 m	⊕	6.00	24.00	47.50	81.00
	1 click = 0.7 cm/100 m	⊕	4.20	16.80	33.25	56.70
7. ring Correction	Number of clicks	⊕	6	14	23	32
	1 click = 1 cm/100 m	⊕	9.00	28.00	57.50	96.00
	1 click = 0.7 cm/100 m	⊕	6.30	19.60	40.25	67.20

For the hunter and target shooter interested in ballistics, two examples of ring selection are given below. A reminder: 1 click = 1 cm at 100 m, or 2 cm at 200 m, or 3 cm at 300 m.

Example: choosing a BDC ring for 7 x 64 caliber, 10.5 g KS bullet for a riflescope with 1.0 cm or 0.7 cm/100 m clickstop mechanism.

	100 m	150 m	200 m	250 m	300 m
Bullet drop according to manufacturer	⊕	-3.1 cm	-10.4 cm	-22.4 cm	-39.6 cm

1st case Riflescope with 1 cm adjustment per click at 100 m, e.g. 2.5–10 x 50 VM/V or 3–12 x 56 Varipoint.

Recommended BDC ring 2 (blue) results in:	⊕	3.0 cm	10.0 cm	22.5 cm	39.0 cm
--	---	--------	---------	---------	---------







2nd case Riflescope with 0.7 cm adjustment per click at 100 m, e.g. 3–9 x 42 VM/V, 5–15 x 42 VM/V or Conquest 3–9 x 40 MC.

Recommended BDC ring 4 (red) results in:	⊕	3.15 cm	11.2 cm	22.75 cm	39.9 cm
---	---	---------	---------	----------	---------

Overview of the technical data.

		Diavari							
		Diavari VM/V 1.5-6 x 42 T*		Diavari VM/V 2.5-10 x 50 T*		Diavari VM/V 3-12 x 56 T*		Diavari VM/V 3-9 x 42 T*	
Magnification		1.5 x	6 x	2.5 x	10 x	3 x	12 x	3 x	9 x
Effective objects lens diameter	(mm)	22.6	42.0	37.7	50.0	44.0	56.0	30.0	42.0
Exit pupil	(mm)	15.0	7.0	15.0	5.0	14.7	4.7	10.0	4.7
Twilight number		4.2	15.9	7.1	22.4	8.5	25.9	8.5	19.4
Field of view	(m/100 m) (ft./100 yds.)	24.0 72.00	6.9 20.70	14.5 43.50	4.0 12.00	12.5 37.50	3.5 10.50	13.2 39.60	4.4 13.20
Eye relief	(mm) (in.)	90 3.54		90 3.54		90 3.54		90 3.54	
Quadratic adjustment range	(cm/100 m) (in./100 m)	204* 73.44*		122* 43.92*		102* 36.72*		138* 49.68*	
Center tube diameter	(mm) (in.)	30 1.18		30 1.18		30 1.18		25.4 1.00	
Objective lens tube diameter	(mm) (in.)	48 1.89		56 2.20		62 2.44		48 1.89	
Eyepiece tube diameter	(mm) (in.)	40 1.57		40 1.57		40 1.57		40 1.57	
Weight with/without rail	(g) (oz.)	467/440 16.47/15.52		494/460 17.43/16.23		555/521 19.58/18.38		461/435 16.26/15.34	
Illum. reticle for sitting game by night	(g)			522/488		583/549			
Weight with/without rail	(oz.)			18.4/17.21		20.56/19.37			
Length	(mm) (in.)	312 12.28		318 12.52		344 13.54		338 13.31	
Parallax-free	(m) (yds.)	100 109.36		100 109.36		100 109.36		100 109.36	
Order numbers	VM	52 16 10		52 16 20		52 16 30		52 16 50	
	V	52 16 11		52 16 21		52 16 31		52 16 51	
Order nos. with illum. reticle	VM			52 16 24		52 16 34			
	V			52 16 25		52 16 35			
	Page	5		6		7		8	
VM = riflescope with rail slot		V = riflescope without rail slot				* = center in alignment to diameter/rail			

Varipoint

Diavari VM/V 5-15 x 42 T*		Diavari V 6-24 x 56 T*		Varipoint VM/V 1.1-4 x 24 T*		Varipoint VM/V 1.5-6 x 42 T*		Varipoint VM/V 2.5-10 x 50 T*		Varipoint VM/V 3-12 x 56 T*	
5 x	15 x	6 x	24 x	1.1 x	4 x	1.5 x	6 x	2.5 x	10 x	3 x	12 x
42.0	42.0	56.0	56.0	16.3	24.0	22.6	42.0	37.7	50.0	44.0	56.0
8.4	2.8	9.3	2.3	14.8	6.0	15.0	7.0	15.0	5.0	14.7	4.7
14.1	25.1	16.9	36.7	3.1	9.8	4.2	15.9	7.1	22.4	8.5	25.9
7.9 23.70	2.6 7.80	6.2 18.60	1.7 5.10	36.0 108.00	10.3 30.90	24.0 72.00	6.9 20.70	14.5 43.50	4.0 12.00	12.5 37.50	3.5 10.50
90 3.54		80 3.15		90 3.54		90 3.54		90 3.54		90 3.54	
82* 29.52*		160/70 57.60/25.20		326* 117.36*		204* 73.44*		122* 43.92*		102* 36.72*	
25.4 1.00		30 1.18		30 1.18		30 1.18		30 1.18		30 1.18	
48 1.89		62 2.44		30 1.18		48 1.89		56 2.20		62 2.44	
40 1.57		45 1.77		40 1.57		40 1.57		40 1.57		40 1.57	
462/437 16.30/15.41		- /805 - /28.40									
		- /825 - /29.10		477/450 16.83/15.87		550/525 19.40/18.52		580/545 20.46/19.22		640/605 22.57/21.34	
338 13.31		377 14.84		300 11.81		325 12.80		325 12.80		357 14.06	
100 109.36		50 - ∞ 55.00 - ∞		100 109.36		100 109.36		100 109.36		100 109.36	
52 16 60											
52 16 61		52 16 90		52 16 14		52 16 04		52 16 28		52 16 38	
		52 16 95		52 16 15		52 16 05		52 16 29		52 16 39	
											
9	10			15		16		17		18	

T* = Zeiss multicoating



Zeiss Conquest – the top line, and not just in the USA.

The Zeiss riflescopes for the American market had to meet a number of requirements: they had to offer high performance, be light and compact, and of the finest quality. Zeiss achieved these goals in full by redesigning the optical systems and using arsenic- and lead-free glass. Additional key features of these riflescopes are generous eye relief, wide fields of view and peak transmission values. With these superb features Zeiss Conquest riflescopes not only fulfil the demands of American hunters and

their local hunting conditions; they are also perfectly suited for target shooting. They offer European hunters a useful addition to their choice of sports optics, suitable for long stalks in wide open plains and hunting in the mountains.

Target shooters, too, appreciate the high magnifications of Conquest riflescopes. The 4.5–14 x 44 MC and 6.5–20 x 50 MC with parallax adjustment are particularly recommended for long-range shooters.

All four Conquest models share a number of practical features.

- 1 inch/25.4 mm diameter of the center tube for ring mounting.
- One-piece tube body offers superb stability.
- Available with hard anodized surface: black or stainless. The latter blends perfectly with stainless or all-weather weapons.
- Several special reticles are available at no extra charge: Mil-Dot, Turkey, Ranging, Z-Plex with extended distance between the posts.
- Non-magnifying reticles throughout the entire power range ensures that the reticle image remains constant, and hides as little of the target as possible at long range.
- Special accessories: lens hoods are available for all Conquest models.
- Easy-to-use reticle adjustment with 1/4 MOA per click, which corresponds to 0.7 cm at 100 meters, allows quick and precise sighting-in.
- No shift in the point of impact after change in magnification or diopter adjustment.
- Continuous diopter adjustment on the eyepiece, from +2 to –3 diopters.
- Zeiss MC multicoating of all glass-to-air surfaces for maximum transmission, color fidelity and brilliance.
- Waterproof in compliance with DIN 58390/80, even with elevation caps removed.
- Nitrogen filling prevents internal fogging.
- Special equipment: all Conquest models can be fitted with a bullet drop compensator, which compensates for the bullet drop of all common hunting loads at a distance of up to 300 meters.
- Only the 6.5–20 x 50 MC is pre-fitted with the bullet drop compensator ex works.

The classic all-rounder.

Conquest 3 - 9 x 40 MC



*The Conquest 3 - 9 x 40 MC.
Available, like all Conquest models, in black or stainless.*

The classic riflescope with a magnification of 3 to 9 times for all-purpose use, originally designed for hunting conditions in America. In Europe, this Conquest model is particularly popular for hunting in the mountains. It is the ideal choice for all those who are looking for a top-quality riflescope for a slug shot-gun, small-bore rifle or Hornet that is light and easy to handle as well as very reliable and robust.

With its objective lens diameter of 40 mm, the image is still clear and brilliant even in unfavorable light conditions. Thanks to the MC multicoating the transmission, reproduction of colors and contrast are excellent. The Conquest 3 - 9 x 40 MC also features an impressively wide field of view of up to 11.3 m at 100 m (33.9 ft. at 100 yds.).



Optimum performance and weight.

Conquest 3.5 - 10 x 44 MC

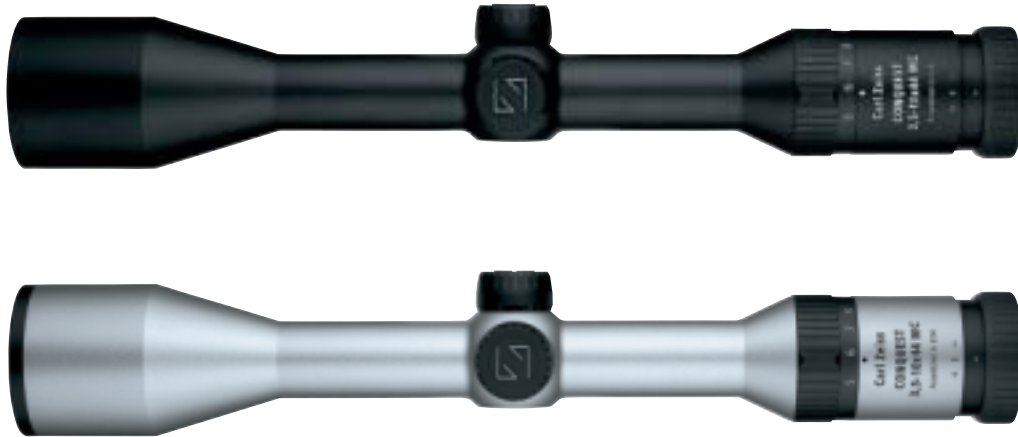

*The Conquest 3.5-10 x 44 MC.
The powerful all-round riflescope.*

It is not just American hunters that like to take this powerful all-round riflescope with them on hunting trips. Its objective lens diameter of 44 mm is 22 % larger than that of the Conquest 3-9 x 40 MC. It weighs a mere 20 g (0.7 oz.) more, and at 322 mm (12.68 in.) it is the shortest model in the Conquest series. Its fast optical system means that it is ideally suited for use in the morning or at dusk.

This model is particularly popular in the Scandinavian countries and for hunting in Alaska. The spectrum of the field of view ranges from 11.7 to 3.9 m at 100 m (35.1 to 11.7 ft. at 100 yds.).



Accurate at great distances.

Conquest 4.5 - 14 x 44 MC with parallax adjustment



*The Conquest 4.5-14 x 44 MC.
The variable riflescope with a high magnification.*

This high-performance riflescope is ideal particularly for hunting small game over great distances and target shooting. In short, it is the Conquest model of choice for anyone who wants a variable-power riflescope with a high magnification.

Parallax adjustment, an important feature on high-power riflescopes, ranges from 27.5 m (30 yds.) to infinity and is performed in next to no time with an extremely easy-grip turret on the left. The riflescope can thus always be focused quickly and conveniently even at maximum magnification at very short as well as extremely long distances.



The specialist for sport and hunting.

Conquest 6.5 - 20 x 50 MC with parallax adjustment



*The Conquest 6.5 – 20 x 50 MC.
Optimum performance for hunting
and target shooting at great distances.*

The Conquest 6.5 – 20 x 50 MC was developed in response to the frequently expressed wish for a riflescope that is equally suited for target shooting and hunting in wide open plains. This high-power, high-performance model is perfect for small targets at long range.

Some European specialists also like to use this kind of riflescope on occasion, and long models of this type are increasingly used in the relevant target shooting disciplines in Germany. This particular riflescope is also in demand for hunting. Game can be appraised perfectly at a distance of up to 300 m even in very poor daylight. Parallax adjustment, a must in this power category, ranges from 45 m (50 yds.) to infinity.



With parallax adjustment:

Conquest 4.5 - 14 x 44 MC, 6.5 - 20 x 50 MC und Diavari 6 - 24 x 56 T*

Both the above high-power Conquest models are always fitted with parallax adjustment. By means of the left-sided adjustment, the riflescope can be set to be parallax-free at any distance ranging from 27 m (30 yds.) or 45 m (50 yds.) to "infinity". The adjustment range on the Diavari 6-24 x 56 T* ranges from 50 m (55 yds.) to infinity.

What does parallax mean?

The explanation of parallax sounds very complicated; in practice, however, it is quite simple. Parallax exists if the axes of two optical systems run at an angle to each other. The point where they intersect is parallax-free; in other words, an object at this point is visible at the same place on both systems. If, however, the object lies on the optical axis of one system before or after this intersection, the result is a difference between the two optical axes: parallax.

When using a riflescope, we are working with two separate optical systems: the eye and the riflescope. When we sight the target through the center of the exit pupil on the riflescope, the optical axis of the eye coincides with that of the riflescope. That means that they are in line without parallax; in this

case, no parallax can occur, no matter how distant the target. If the field of view is circular and sharply defined, you are looking through the center of the exit pupil.

However, if you look through the riflescope from one side, from above or below, the target can be seen parallax-free only at one particular point or distance. This distance can be determined during the riflescope alignment, and is normally 100 meters or 100 yards (91.4 m). Target errors caused by parallax can be virtually ignored at normal shooting distances. On a Carl Zeiss riflescope with an objective lens diameter of 56 mm set to be parallax-free at 100 m, the parallax error caused by oblique viewing through the scope of a target 50 or 150 m away will result in a maximum shift in the point of impact of 7 mm. For hunting in the mountains or in treeless terrain, where only shots at long range are possible, it is essential both to establish the distance as accurately as possible and to eliminate all target errors. Parallax adjustment in the riflescope offers both hunters and long-range target shooters major advantages.

To prevent any displacement in the point of aim, parallax adjustment must be extremely precise.

Conquest 4.5 - 14 x 44 MC

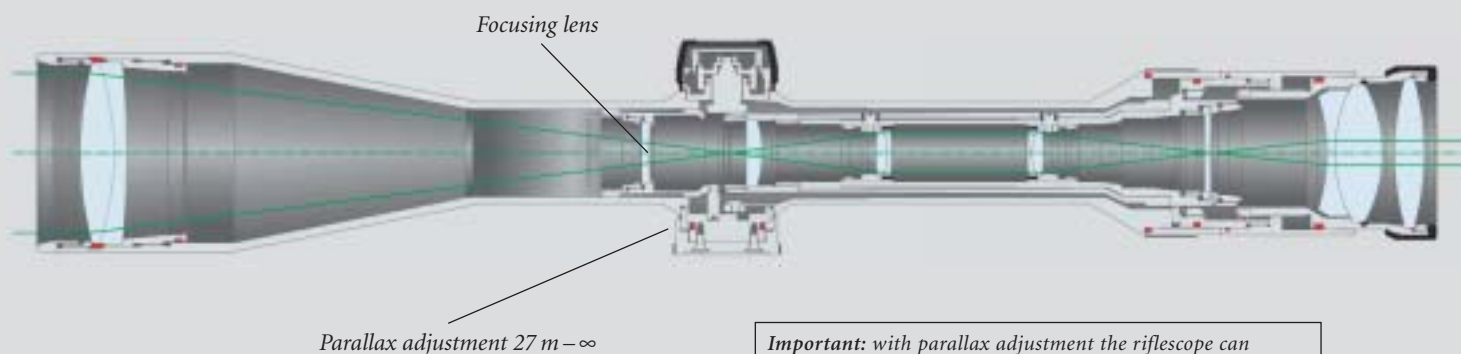

Important: with parallax adjustment the riflescope can always be focused even at maximum magnification at extremely short as well as extremely long distances.

Valuable information about the reticles in the Conquest series.

Reticles 4, 20 and 21, which are popular in Europe, are available for all models. The Z-Plex reticle (20) on the 3–9 x 40 MC, at five times magnification, has an aperture of 50 cm between the thick posts at 100 m. The aperture on models 3.5–10 x 44 MC, 4.5–14 x 44 MC and 6.5–20 x 50 MC, at ten times magnification, is 50 cm at a distance of 100 m.

The Mil-Dot reticle 43, which is available for all Conquest models, displays eight horizontal and vertical dots on the thin hairs in the center of the reticle. The distance between these dots on the 3–9 x 40 MC, at five times magnification, amounts to 10 cm at 100 m. On models 3.5–10 x 44 MC, 4.5–14 x 44 MC and 6.5–20 x 50 MC, at ten times magnification, the distance between two dots is also 10 cm.

For model 3–9 x 40 MC, reticle 57 (Turkey reticle) is available. This was designed specifically for turkey hunting, which is popular in the USA. The aperture of the inner circle varies according to the

magnification between 35 cm (at three times magnification) and 11.5 cm (at nine times magnification) at a distance of 100 m.

The Ranging reticle 58 is available for all Conquest models. The aperture between the two horizontal posts on the 3–9 x 40 MC model, at five times magnification, amounts to 32 inches at 100 yards, which corresponds to 90 cm at 100 m. On models 3.5–10 x 44 MC, 4.5–14 x 44 MC and 6.5–20 x 50 MC, these aperture measurements are found at ten times magnification. The six horizontal lines in the bottom right quadrant are for estimating distance (1 $\hat{=}$ 100 m, 2 $\hat{=}$ 200 m, 6 $\hat{=}$ 600 m). The distance between the center line and the different horizontal lines can be used to establish the distance*: if a 50 cm high target (fig. 1) covers the distance from the center line to the lowest line (labeled 1) this means that the distance from the target amounts to 100 m (see fig. 2). If an identical target (50 cm in height) only covers the distance from the center line to the horizontal line labeled 3 (fig. 3) this means that the distance from the target amounts to 300 m.

** To do this set the Conquest 3–9 x 40 MC to a magnification of 5 times, and the other three Conquest models to a magnification of 10 times.*

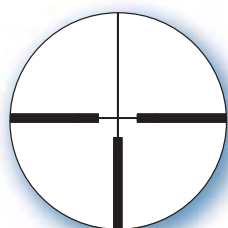

Reticle 4

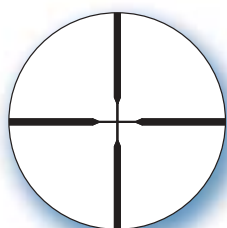

Reticle 20
(Z-Plex)

No illuminated reticles are supplied for Conquest riflescopes.

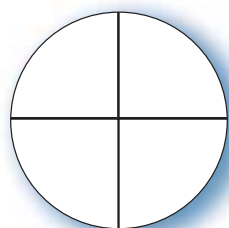

Reticle 21

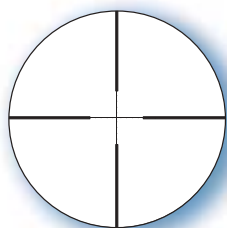

Reticle 43
(Mil-Dot)

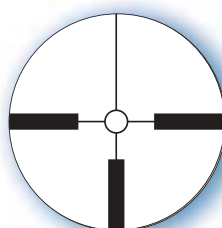

Reticle 57
(Turkey)

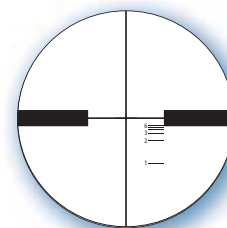

Reticle 58
(Ranging)

Overview of the technical data.

Conquest								
	Conquest 3-9 x 40 MC		Conquest 3.5-10 x 44 MC		Conquest 4.5-14 x 44 MC		Conquest 6.5-20 x 50 MC	
Magnification	3x	9x	3.5x	10x	4.5x	14x	6.5x	20x
Effective objective lens diameter (mm)	40		40	44	44		50	
Center tube diameter (mm) (in.)	25.4 1.0		25.4 1.0		25.4 1.0		25.4 1.0	
Field of view (m at 100 m) (ft. at 100 yds.)	11.3 33.90	3.7 11.10	11.7 35.10	3.9 11.70	8.3 24.90	2.8 8.40	5.9 17.70	1.9 5.70
Parallax-free (m) (yds.)	91.4 100		91.4 100		27.5 30	∞ ∞	45 50	∞ ∞
Exit pupil (mm)	13.3	4.4	12.54	4.4	9.7	3.14	7.7	2.5
Twilight number	8.5	19	9.9	20.9	12.7	24.8	18	31.6
Eye relief (mm) (in.)	102 4.02		89 3.50		89 3.50		89 3.50	
Length (mm) (in.)	330 12.99		322 12.68		352 13.86		396 15.59	
Weight (g) (oz.)	430 15.17		450 15.87		485 17.11		619 21.83	
Adjustment per click	0.7 cm/100 m 1/4 MOA		0.7 cm/100 m 1/4 MOA		0.7 cm/100 m 1/4 MOA		0.7 cm/100 m 1/4 MOA	
Min. quadratic adjustm. range (cm/100 m) (in./100 yds.)	178 64.08		183 65.88		119 42.84		126/80 45.36/28.80	
Diopter adjustment range	+2/-3 dpt		+2/-3 dpt		+2/-3 dpt		+2/-3 dpt	
Order numbers black	52 14 60		52 14 20		52 14 30		52 14 50	
Order numbers stainless	52 14 64		52 14 24		52 14 34		52 14 54	
Page	27		28		29		30	

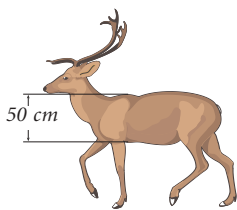

Reticle 58:

Fig. 1

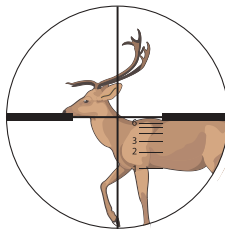

Fig. 2: 100 meters

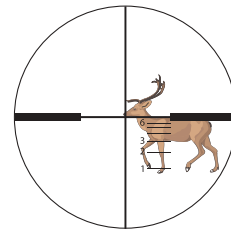

Fig. 3: 300 meters



Elevation after sighting in:
 1. Pull elevation out
 2. Turn zero mark to index mark
 3. Press elevation back down

Available reticles

Conquest 3 - 9 x 40 MC

Conquest 3.5 - 10 x 44 MC

Conquest 4.5 - 14 x 44 MC

Conquest 6.5 - 20 x 50 MC

Reticle					
4	20	21	43	57	58
•	•	•	•	•	•
•	•	•	•		•
•	•	•	•		•
•	•	•	•		•

The alternative.

Z-Point – the innovative reflex sight.



*The Z-Point reflex sight.
The compact sighting
instrument with
innovative features.*

With its first reflex sight, Carl Zeiss offers an innovative sighting instrument endowed with state-of-the-art optical and electronic systems. The Z-Point also boasts a number of impressive exclusive features that set it apart from models made by other manufacturers.

The best example is the hybrid power supply: a combination of battery and solar cell. This Zeiss patent is the first of its kind in the world. By daylight, the solar cell supplies power to the red illuminated reticle, saving the battery and prolonging its life. As the daylight fades, the electronic system switches over automatically to battery operation.

A further innovation is the fact that the basic brightness of the red dot can be individually set and stored, after which it adjusts automatically to the surrounding light conditions. A new, patented optical arrangement of the dot illuminator means that the red dot remains equally bright even when viewed at an angle. In addition, the dot always stays in the center of the ray path after the Z-Point is sighted in.

This makes it much easier to aim rapidly at the target. The Z-Point is therefore ideal for drive hunts – particularly on narrow aisles. You always have the proper overview with both eyes open.

Other features of the Z-Point in brief:

- Digital function control via a computer chip
- Automatic "Off" function
- One-button function operation
- Suitable for rifles, shotguns, small-arms, handguns, CO₂ rifles and air rifles, etc.
- Spring clamp for Picatinny rail (or Weaver rail)
- Mounted and removed in seconds
- Small dimensions, low weight

*Z-Point combined with a repeater of drive hunt caliber:
light and easy to handle.*





It goes without saying that the Z-Point satisfies all the requirements of a quality sight. It is recoil-proof, waterproof, shock-resistant and vibration-resistant. Its casing consists of glass fiber-reinforced material with an integrated tube body of high-strength aluminum.

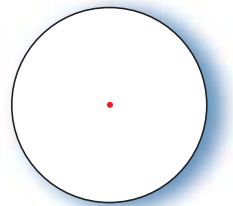

Z-Point illuminated reticle

Z-Point reflex sight	
Magnification	1 x
Dot size	10 cm at a distance of 100 m
Adjustment range	± 2 m at 100 m, quadratic: ± 1.4 m at 100 m
Transmission	78 % in spectral range 400 nm – 1,000 nm
Power supply	Solar cells, 3 V lithium button cell CR 2032
Dimensions	Height: 44.5 mm Width: 36 mm, Length: 63.5 mm
Weight	100 g excluding battery
Order number 52 16 98	

The Z-Point can be used successfully for Practical Shotgun Shooting.

Handguns with Z-Point for Practical Pistol Shooting.





Carl Zeiss
Sports Optics
Gloelstrasse 3-5
D-35576 Wetzlar
www.zeiss.de/sportsoptics

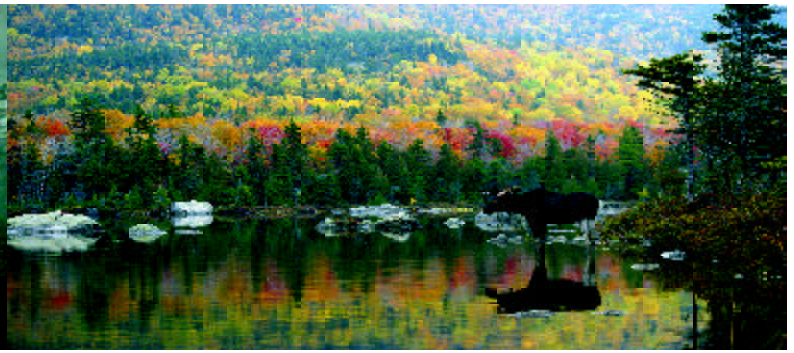

Diavari ZM/Z 3-1 2x56 MC Classic Performance, Extraordinary Value.

Around the world, sportsmen have come to associate the name Carl Zeiss with performance and innovation. Since the introduction of our first riflescope in 1904, Zeiss has steadfastly committed itself to the ethos that our customers should experience uncommon performance. North American shooters and hunters have marveled at our ability to combine optical performance with mechanical reliability in a unique way, to deliver incredible images and years of trouble-free service. The 1990's ushered in a new era. Trusted firms discovered that the globalization of manufacturing enabled them to deliver traditional performance while taking advantage of the economies afforded by re-thinking manufacturing strategies. In 1996, Zeiss introduced its first riflescope assembled in the United States.

The overwhelming success of this product supported our belief that our customers could enjoy traditional Zeiss performance and extraordinary value.

The ZM/Z 3-12x56 MC riflescope, assembled in the United States, reflects our unwavering commitment to our legacy of craftsmanship and innovation. These values are so interwoven into our philosophy that the introduction of this scope is a natural extension of our line. Now, you can experience the field proven performance that has made Zeiss a world respected name in riflescopes, while enjoying extraordinary value made possible through the globalization of our manufacturing. We trust that sportsmen around the world will agree that Zeiss has once again set the standard by which all others are judged.



Illuminated model shown

Unbeatable in extremely low light.

As the first light of dawn seeps into the valley or the fading light of sunset leaves darkened shadows in the forest below, you wait patiently. Suddenly you notice movement in the distance and slowly raise your rifle. You know immediately, why

the Diavari ZM/Z 3-12x56 MC is in a class by itself. Crisp detail and true color rendition are just a few of the hallmarks that have made Zeiss the performance standard. Enjoy seeing images you did not believe possible, even in the worst conditions.

Magnification	3-12	Twilight factor	8.5/25.9
Max. adj.- elevation and windage (in./100 yds)	34.2	Ocular bell diameter (inches)	1.57
Effective objective diameter (mm)	38.1/56	Field of view (feet @100 yards)	27.6/9.9
Center tube diameter (mm/inches)	30/1.18	Length (inches)	15.3
Diameter of exit pupil (mm)	12.7/4.7	Eye relief (inches)	3.2
Objective bell diameter (inches)	2.4	Weight (ounces)	25.8
		Parallax free (yards)	109.4

Zeiss has a wide selection of reticles to meet your shooting needs.

Choosing the right reticle depends upon the hunting situation and the shooter's preference. Zeiss offers a wide selection of reticles. Order your ZM/Z 3-12x56 MC riflescope with the reticle that best meets your shooting needs. Whether you,

prefer a conventional reticle or an illuminated reticle, Zeiss offers a solution. If you prefer bullet-drop compensation, contact us and we will assist you in selecting the right system for you.

Non-Illuminated Reticles

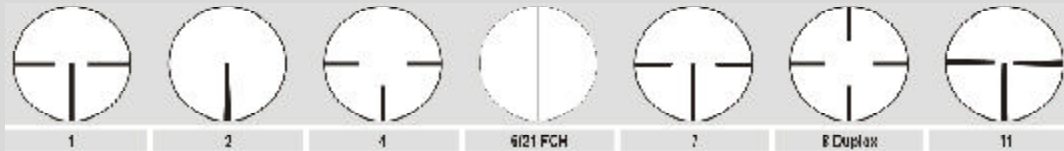

Reticles 1, 2, 4, 6, 7, and 11 are available through special order.

Take the guesswork out of aiming.

The light is fading fast. However, you can not only see the target but the reticle stands out clearly against the dark silhouette. You slowly squeeze the trigger and conclude another successful hunt. The Zeiss illuminated reticle system

offers convenient intensity adjustment, so you can adjust it for a variety of lighting conditions. The large area of illumination and generous eye relief make it easy to quickly place the point of impact on the target. We think you will agree Zeiss offers a better solution.

Illuminated Reticles Reticle 8 Illuminated - Standard



Reticle subtensions

Dot 40/80: 1.08 in. @ 100 yards

Crosshairs 44/88: 3.6 in. @ 100 yards

Crosshairs 8: 25.2 in. @ 100 yards

Reticles 40, 44, 80, and 88 are available through special order.

Carl Zeiss Optical, Inc.
13005 N. Kingston Avenue
Chester, VA 23836
1-800-441-3005
www.zeiss.com

