

# REDDING

RELOADING EQUIPMENT

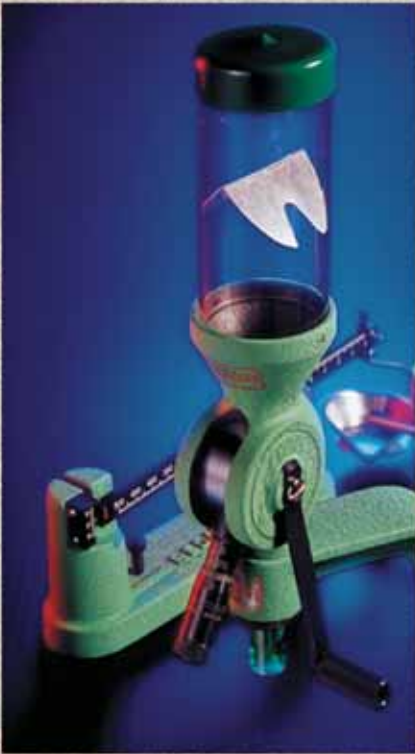

2007  
PRODUCT  
CATALOG

**W**elcome to the pages of our 2007 product catalog. Redding has been producing quality reloading tools for over 60 years. We have built an enviable reputation by listening to, and helping our customers. Many of our products are unlike any other in the marketplace and are often created as a result of our constant quest to help our customers produce better, more accurate ammunition.

Much of our success should also be attributed to our dedicated employees who truly enjoy the products they build. They do not accept mediocrity and fully understand "it is not quality until the customer says it is".

We hope you find the information on these pages both interesting and technically informative. Be sure to visit our website [www.redding-reloading.com](http://www.redding-reloading.com) for additional information.

If you need further assistance, we welcome your calls and e-mails, our staff is ready to help.



Richard Beebe, President



Offices of Redding Manufacturing – Cortland, N.Y.



Richard Beebe – Canada Moose  
Turnagain River, British Columbia

## New Products for 2007!

### The Big Boss II Reloading Press

Page 25



### Case Neck Gauge

Page 23

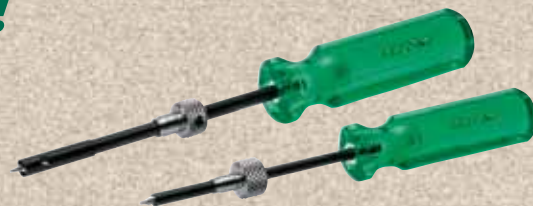

### Flash Hole Deburring Tools

Page 23

### Primer Pocket Uniformers

Page 23



### Stainless Pilot Stops

Page 23



### Plus Dies For:

- 17 Remington Fireball
- 6 X 47 Lapua
- 6.5 X 47 Lapua
- 6.5 GRENDEL™
- 30 TC
- 308 Marlin Express
- 375 Ruger
- 470 Nitro Express

# Competition Bullet Seating Die for Handgun & Straight Wall Rifle Cartridges

## The Most Advanced Bullet Alignment Available

### Advanced Bullet Alignment

Our design criteria called for positive alignment between the bullet and cartridge case prior to bullet seating.

We developed a very unique way to intentionally bias the bullet into alignment. Here is how it works:

The precision fitting seating stem is allowed to move well down into the chamber of the die to accomplish early bullet contact. The spring loading of the seating stem provides the positive alignment bias between its tapered nose and the bullet ogive. This spring loading and bullet alignment are maintained as the bullet and cartridge case move upward until the actual seating of the bullet begins.

This new Advanced Bullet Alignment feature assures you of the straightest possible bullet alignment for handgun and straight wall rifle cartridges.

### Micrometer Adjustment

The micrometer adjustment simplifies setting and recording bullet seating depth. By recording the micrometer setting of your favorite reloads you can return to that same overall length by simply "dialing it in". Switching bullets and experimentation has never been easier. The micrometer is calibrated in .001" increments, is infinitely adjustable and has a "zero" set feature that allows you to set your favorite load to zero if desired.

### Separate Crimp

Competition shooters are reloaders who know that superior reloads are produced when bullet crimping is performed as a separate operation from bullet seating. This is a no compromise die with no crimping capability provided. A superior crimp will be accomplished by using our "Profile Crimp" or "Taper Crimp" die.

### Progressive Press Compatible

The new Competition Seating Die for straight wall cartridges has been made compatible with all popular progressive reloading presses. The industry standard 7/8 -14 threaded die bodies have been slightly extended to allow full thread engagement of the lock ring. An oversize bellmouth chamfer with smooth radius has been added to the bottom of the die to ease case and bullet entry in progressive presses.

See chart for available calibers and ordering numbers . . . . . **\$96.00**

*Since the introduction of our Competition Seating Die for rifle calibers, we have been asked to provide the same features in a precision bullet seater for straight wall cartridges. Because of our strict design criteria it was only natural that this die would become part of our Competition Series.*



U.S. Patent No. 6,244,154

### Handgun Cartridges

Cartridge	Item No.
9MM Luger	55172
38 Super Auto	55271
38 Special/357 Magnum	55282
40 S&W/10MM Auto	55253
41 Magnum	55185
44 Special/44 Magnum	55286
45 ACP & (45 GAP)	55189
45 Colt/454 Casull	55191
460 S&W Magnum	55278
500 S&W Magnum	55291

### Straight Wall Rifle Cartridges

Cartridge	Item No.
38-40 Winchester	55366
38-55 Winchester	55365
40-65 Winchester	55465
44-40 Winchester	55188
45-70 Government	55209



*"I recommend Redding dies to all my custom rifle and handgun customers because of my success using Redding products."*

**Don Golembieski**

Now anyone with a standard reloading press can benefit from advanced benchrest techniques.

## Type S – Bushing Style Dies

The amount of resizing provided by conventional reloading dies has always been dictated by the manufacturing tolerances (SAAMI specifications) of the brass cartridge case itself. Reloading die manufacturers have been forced to design the neck diameter of their dies small enough to accommodate the thinnest possible brass.

This may be as much as .008" - .010" smaller than the maximum cartridge dimensions typically shown in most reloading manuals.

Since the majority of cases that the reloader is likely to encounter in the field are thicker than the minimum specifications that the dies were designed for, case necks are often resized excessively.

It can be easily demonstrated that excessive resizing of the cartridge case quickly leads to stress distortion and concentricity problems.

The new Type S - Bushing Style Dies offer a simple solution to this age old problem.



**The Type S - Bushing Style Dies, Competition Seating and Neck Sizing Dies, Body Dies and our New Competition Shellholders are all products of Benchrest and 1000 yard Competition.**

## Type S – Neck Bushing Die

The new Type S - Bushing Style Neck Sizing Die provides reloaders with a simple means to precisely control case neck size and tension.

- Uses interchangeable sizing bushings available in .001" increments.
- The adjustable decapping rod allows positioning the bushing to resize only a portion of the neck length if desired.
- Concentricity is enhanced by the ability of the resizing bushing to self-center on the case neck.
- The decapping rod is supplied with a standard size button. This is especially useful for reloaders who are using commercial brass as is.
- A decapping pin retainer is also supplied with all Type S - Bushing Dies. This enables neck sizing without the use of the size button for those who sort and/or turn case necks for uniformity.

All dies are supplied without bushings. For ordering numbers see pages 4 & 5

Category I . . . . .	\$67.50
Category II . . . . .	82.50
Category III . . . . .	102.00

Carbide size button kits are also available for all Type S Dies. See page 13 for kit numbers by caliber.

## Type S – Full Bushing Die

Full length resizing while maintaining exact control of the case neck is often desirable in one operation. The new Type S - Full Length Resizing/Bushing Die accomplishes this task with the precision you would expect from Redding.

- Uses the same interchangeable bushings (.001" increments) as those used in our bushing style neck sizing dies.
- The adjustable decapping rod allows you to adjust the bushing position, sizing only part of the neck length when desired.
- Concentricity is enhanced by the ability of the bushing to self-center on the neck of the cartridge case.
- All Type S dies are supplied with both the standard size button and a decapping pin retainer for the advantages and versatility described under our Type S - Bushing Style Neck Sizing Dies.

All dies are supplied without bushings. For ordering numbers see pages 4 & 5

Category I . . . . .	\$67.50
Category II . . . . .	82.50
Category III . . . . .	102.00

**Note: For the ultimate shoulder bump control, use these dies with our new Competition Shellholders. See page 14 for details.**

# Competition Bushing Style - Neck Sizing Die

Similar in design concept to our Competition Seating Die, the cartridge case is completely supported and aligned with the sizing bushing before the sizing process begins.

As the sizing process starts, the cartridge case remains supported in the tightly chambered, sliding sleeve as it moves upward while the resizing bushing self-centers on the case neck.

The decapping rod is maintained in precise alignment by using the internal parts of the die as a linear support much like that of a firing pin.

Meanwhile, the micrometer adjustment of the bushing position delivers precise control to the desired amount of neck length to be sized.

This die was designed for use by Competition Shooters who have meticulously prepared their cartridge cases and do not wish to use a sizing button, however, carbide size button kits are available separately. Refer to pages 4 & 5 for kit numbers by caliber.

All dies are supplied without bushings. For ordering numbers, see pages 4 & 5

- Category I ..... \$127.50
- Category II ..... 154.50
- Category III ..... 189.00

## Neck Sizing Bushings

Redding Neck Sizing Bushings are available in two styles. Both share the same external dimensions (1/2" O.D. x 3/8" long) and freely interchange in all Redding Bushing style Neck Sizing Dies.

They are available in .001" size increments throughout the range of .185" thru .368", covering all calibers from .17 to .338 and clearly marked with size I.D.

By selecting the correct bushing, you are now able to provide just the right amount of neck tension to properly hold the bullet without excessive resizing.

Item No. 73185 thru 73368 (specify size) ..... \$16.20

**Heat treated steel.** The sizing diameters are hand-polished with a surface hardness of Rc 60-62 to reduce sizing effort.

Item No. 76185 thru 76368 (specify size) ..... \$28.80

Heat treated steel as above with the addition of a *Titanium Nitride* surface treatment to further increase the effective surface hardness and reduce sizing friction.

Item No. 76999 ..... \$2.70

Handy bushing storage box is available separately.

## Body Dies

Redding has been making Body Dies for Benchrest Shooters for years, but they were never a catalogued item.

Now, with the introduction of the Bushing-Style Neck Sizing Dies, they are available as a companion item for most cartridges.

Body Dies are designed to full length resize the case body and bump the shoulder position for proper chambering without disturbing the case neck. They are made without internal parts and intended for use only to resize cases which have become increasingly difficult to chamber after repeated firing and neck sizing.

- Category I ..... \$33.90
- Category II ..... 41.40
- Category III ..... 51.00

For ordering numbers, see pages 4 & 5



**Note: For the ultimate shoulder bump control, use these dies with our new Competition Shellholders. See page 14 for details.**

**The revolutionary Competition Neck Sizing Die with interchangeable bushings brings an advanced level of precision to Competition Shooters.**

U.S Patent No. 5,649,465



### — Tech Talk —

#### Bushing Selection and Use

The easiest way to determine the proper diameter bushing, is to measure the neck diameter of several loaded or dummy cartridges with an accurate micrometer. Subtract .001" from the smallest average neck diameter and this diameter bushing will generally size case necks to create the proper press fit for the bullet.

**Note:** If the neck wall thickness of your cases is on the thin side of the SAAMI tolerance, your fired case necks will measure considerably larger (.006-.010" larger) than your loaded cartridges. Under these circumstances, our tests have shown that a bushing .001" larger may give the desired results.

Another method is to measure the neck thickness with a ball micrometer. Double the neck wall thickness and add this number to the bullet diameter. The result is the neck diameter of a loaded cartridge, and bushing size can be determined as above.

After loading several cases, it's a good idea to test the neck's grip on the bullet. The simplest method is to push the bullet in a loaded cartridge against the edge of your reloading bench with moderate hand pressure. The bullet should not move easily in the case neck. If the bullet pushes deeper in the case, select the next smaller bushing and start again.

When using your bushing die, we have found that lubricating case necks and installing the bushing numbers down may improve results. Many reloaders like to adjust the die to size 1/2 to 3/4 of the case neck. This has been shown to improve accuracy in some instances.

# Competition Bullet Seating Die

**“No seating die on the market is built to this level of precision.”**

US Patent No. 4,862,567



The Redding Competition Seating Die has quickly established itself as the “state of the art” in straight line bullet seaters.

This design, covered by U.S. Patent No. 4,862,567, has beat the concentricity problems inherent in all other seating dies of this type.

Tighter manufacturing tolerances have been made possible due to the details of the patented seating stem system. The bullet guide to seating stem fit is so precise that the seating stem can actually be demonstrated to “float” on a column of air.



“Zero” set feature.

The seating stem is precision ground to exactly match bullet diameter. No seating die on the market is built to this level of precision. Alignment and accuracy are enhanced by the cartridge case and bullet being completely supported and aligned in a close fitting, precision ground sleeve before the bullet seating begins.

The micrometer is calibrated in .001" increments for precise seating depth and is infinitely adjustable (without clicks). The micrometer also has a “zero” set feature that allows you to zero the micrometer to your rifle or favorite seating depth.

For ordering numbers see chart below.

- Category I . . . . . \$127.50**
- Category II . . . . . 154.50**
- Category III . . . . . 189.00**

**“The Redding Competition Seaters are without question the finest bullet seaters I have ever used! The quality of construction and design is a ‘steal!’**

**I am extremely impressed.”**

**- Fred Sinclair, Sinclair International  
New Haven, Indiana**

## Bushing Style Dies

Cartridge	Type S – Full Bushing Die	Type S – Neck Bushing Die	Type S – Neck Bushing Die Set	Type S – Match Full Die Set	Type S – Match Neck Die Set	Body Die	Competition Bushing Neck Die	Competition Seating Die	Competition Bushing Neck Die Set	Carbide Kit For Competition Bushing Die
<b>CATEGORY I</b>	<b>\$67.50</b>	<b>\$67.50</b>	<b>\$124.50</b>	<b>\$184.50</b>	<b>\$216.00</b>	<b>\$33.90</b>	<b>\$127.50</b>	<b>\$127.50</b>	<b>\$273.00</b>	<b>\$37.20</b>
204 Ruger	77287	71287	78287	36287	38287	75287	56287	55287	58287	N.A.
222 Remington	77109	71109	78109	36109	38109	75109	56109	55109	58109	98123
223 Remington	77111	71111	78111	36111	38111	75111	56111	55111	58111	98123
22-250 Remington	77106	71106	78106	36106	38106	75106	56106	55106	58106	98123
220 Swift	77107	71107	78107	36107	38107	75107	56107	55107	58107	98223
6MM P.P.C. USA	77319	71319	78319	36319	38319	75319	56319	55319	58319	98024
6MM B.R. Rem (Norma BR)	77317	71317	78317	36317	38317	75317	56317	55317	58317	98024
243 Winchester	77114	71114	78114	36114	38114	75114	56114	55114	58114	98224
6MM Remington	77115	71115	78115	36115	38115	75115	56115	55115	58115	98224
25-06 Remington	77120	71120	78120	36120	38120	75120	56120	55120	58120	98325
260 Remington	77531	71531	78531	36531	38531	75531	56531	55531	58531	98226
6.5 x 55 Swedish	77132	71132	78132	36132	38132	75132	56132	55132	58132	98226
270 Winchester	77135	71135	78135	36135	38135	75135	56135	55135	58135	99427
7MM-08 Remington	77139	71139	78139	36139	38139	75139	56139	55139	58139	99383
280 Remington	77142	71142	78142	36142	38142	75142	56142	55142	58142	99483
7MM Remington Mag	77136	71136	78136	36136	38136	75136	56136	55136	58136	99483
308 Winchester	77155	71155	78155	36155	38155	75155	56155	55155	58155	99307
30-06 Springfield	77148	71148	78148	36148	38148	75148	56148	55148	58148	99407
300 Rem SA UM	77275	71275	78275	36275	38275	75275	56275	55275	58275	99307
300 Winchester Mag	77153	71153	78153	36153	38153	75153	56153	55153	58153	99407
300 Weatherby Mag	77252	71252	78252	36252	38252	75252	56252	55252	58252	99507
300 Rem Ultra Mag	77288	71288	78288	36288	38288	75288	56288	55288	58288	99507
300 WSM	77223	71223	78223	36223	38223	75223	56223	55223	58223	99307
<b>CATEGORY II</b>	<b>\$82.50</b>	<b>\$82.50</b>	<b>\$153.00</b>	<b>\$223.50</b>	<b>\$262.50</b>	<b>\$41.40</b>	<b>\$154.50</b>	<b>\$154.50</b>	<b>\$331.50</b>	<b>\$37.20</b>
<b>NEW</b> 17 Remington Fireball	77204	71204	78204	36204	38204	75204	N.A.	55204	N.A.	N.A.
17 MACH IV	77504	71504	78504	36504	38504	75504	N.A.	55504	N.A.	N.A.
17 Remington	77217	71217	78217	36217	38217	75217	N.A.	55217	N.A.	N.A.
22 Hornet	77102	71102	78102	36102	38102	75102	N.A.	55102	N.A.	N.A.
221 Remington Fireball	77101	71101	78101	36101	38101	75101	56101	55101	58101	98023
223 Remington Imp 40°	77907	71907	78907	36907	38907	75907	56907	55907	58907	98123
22 P.P.C. USA	77318	71318	78318	36318	38318	75318	56318	55318	58318	98023
22 B.R. Remington	77316	71316	78316	36316	38316	75316	56316	55316	58316	98023
22-250 Rem Imp 40°	77406	71406	78406	36406	38406	75406	56406	55406	58406	98123
223 WSSM	77295	71295	78295	36295	38295	75295	56295	55295	58295	98123
243 WSSM	77270	71270	78270	36270	38270	75270	56270	55270	58270	98124
243 Win Imp 40°	77420	71420	78420	36420	38420	75420	56420	55420	58420	98224
6MM Rem Imp 40°	77421	71421	78421	36421	38421	75421	56421	55421	58421	98224
6MM/284 Winchester	77414	71414	78414	36414	38414	75414	56414	55414	58414	98224

# Bushing Style Die Sets

## TYPE S - MATCH Bushing Full Die Set

- Type S - Bushing Full Sizing Die
- Competition Seating Die

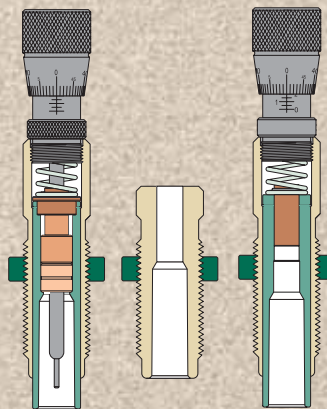

## TYPE S - MATCH Bushing Neck Die Set

- Type S - Bushing Neck Sizing Die
- Body Die
- Competition Seating Die

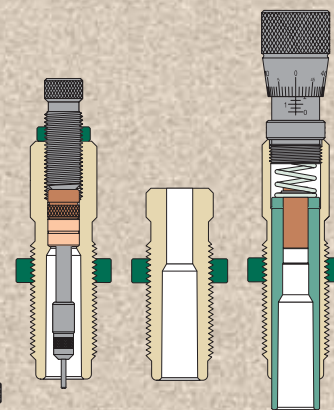

## COMPETITION Bushing Neck Die Set

- Competition Bushing Neck Sizing Die
- Body Die
- Competition Seating Die

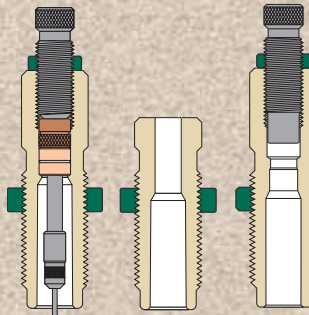

## TYPE S Bushing Neck Die Set

- Type S - Bushing Neck Sizing Die
- Body Die
- Regular Series 92000 Seating Die

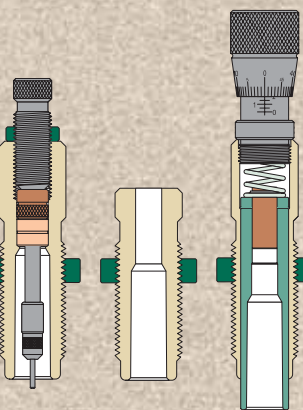

# Bushing Style Dies *Continued*

Cartridge	Type S - Full Bushing Die \$82.50	Type S - Neck Bushing Die \$82.50	Type S - Neck Bushing Die Set \$153.00	Type S - Match Full Die Set \$223.50	Type S - Match Neck Die Set \$262.50	Body Die \$41.40	Competition Bushing Neck Die \$154.50	Competition Seating Die \$154.50	Competition Bushing Neck Die Set \$331.50	Carbide Kit For Competition Bushing Die \$37.20
<b>CATEGORY II-Cont'd.</b>	<b>\$82.50</b>	<b>\$82.50</b>	<b>\$153.00</b>	<b>\$223.50</b>	<b>\$262.50</b>	<b>\$41.40</b>	<b>\$154.50</b>	<b>\$154.50</b>	<b>\$331.50</b>	<b>\$37.20</b>
25 WSM	77263	71263	78263	36263	38263	75263	56263	55263	58263	98125
6.5MM/284 Win (Norma)	77415	71415	78415	36415	38415	75415	56415	55415	58415	98226
6.5MM/06 (A-Square)	77378	71378	78378	36378	38378	75378	N.A.	55378	N.A.	N.A.
6.8MM Rem SPC	77259	71259	78259	36259	38259	75259	56259	55259	58259	99127
270 WSM	77255	71255	78255	36255	38255	75255	56255	55255	58255	99227
7MM B. R. Remington	77241	71241	78241	36241	38241	75241	56241	55241	58241	99183
280 Rem Improved 40°	77428	71428	78428	36428	38428	75428	56428	55428	58428	99483
7MM Rem SA UM	77280	71280	78280	36280	38280	75280	56280	55280	58280	99383
7MM WSM	77265	71265	78265	36265	38265	75265	56265	55265	58265	99383
7MM STW	77544	71544	78544	36544	38544	75544	56544	55544	58544	99583
7MM Rem Ultra Mag	77923	71923	78923	36923	38923	75923	56923	55923	58923	99583
338 Winchester Mag	77163	71163	78163	36163	38163	75163	56163	55163	58163	99433
338 Rem Ultra Mag	77874	71874	78874	36874	38874	75874	56874	55874	58874	99533
<b>CATEGORY III</b>	<b>\$102.00</b>	<b>\$102.00</b>	<b>\$186.00</b>	<b>\$274.50</b>	<b>\$324.00</b>	<b>\$51.00</b>	<b>\$189.00</b>	<b>\$189.00</b>	<b>\$406.50</b>	<b>\$37.20</b>
20 Vartarg	77636	71636	78636	36636	38636	75636	N.A.	55636	N.A.	N.A.
20 P.P.C.	77566	71566	78566	36566	38566	75566	N.A.	55566	N.A.	N.A.
20 B.R.	77666	71666	78666	36666	38666	75666	N.A.	55666	N.A.	N.A.
20 Tactical	77660	71660	78660	36660	38660	75660	56660	55660	58660	N.A.
6mmXC	77745	71745	78745	36745	38745	75745	N.A.	55745	N.A.	98224
<b>NEW</b> 6 x 47 Lapua	<b>77489</b>	<b>71489</b>	<b>N.A.</b>	<b>36489</b>	<b>38489</b>	<b>75489</b>	<b>N.A.</b>	<b>55489</b>	<b>N.A.</b>	<b>N.A.</b>
6MM/22-250	77516	71516	78516	36516	38516	75516	56516	55516	58516	98224
250 Savage	77122	71122	78122	36122	38122	75122	56122	55122	58122	98125
257 Roberts	77125	71125	78125	36125	38125	75125	56125	55125	58125	98225
257 Roberts Imp 40°	77322	71322	78322	36322	38322	75322	56322	55322	58322	98225
25-06 Rem Imp 40°	77422	71422	78422	36422	38422	75422	56422	55422	58422	98325
257 Weatherby Mag	77226	71226	78226	36226	38226	75226	56226	55226	58226	98325
<b>NEW</b> 6.5 GREND <sup>TM</sup>	<b>77478</b>	<b>N.A.</b>	<b>N.A.</b>	<b>36478</b>	<b>N.A.</b>	<b>N.A.</b>	<b>N.A.</b>	<b>55478</b>	<b>N.A.</b>	<b>N.A.</b>
<b>NEW</b> 6.5 x 47 Lapua	<b>77479</b>	<b>71479</b>	<b>N.A.</b>	<b>36479</b>	<b>38479</b>	<b>75479</b>	<b>N.A.</b>	<b>55479</b>	<b>N.A.</b>	<b>N.A.</b>
264 Winchester Mag	77127	71127	78127	36127	38127	75127	56127	55127	58127	98326
7MM TCU	77242	71242	78242	36242	38242	75242	56242	55242	58242	99283
7MM X 57 Mauser	77138	71138	78138	36138	38138	75138	N.A.	55138	N.A.	N.A.
284 Winchester	77141	71141	78141	36141	38141	75141	56141	55141	58141	99383
7MM Weatherby Mag	77237	71237	78237	N.A.	N.A.	75237	N.A.	N.A.	N.A.	N.A.
30 B.R.	77524	71524	78524	36524	38524	75524	N.A.	55524	N.A.	99607
30-30 Winchester	N.A.	71146	78146	N.A.	N.A.	75146	N.A.	N.A.	N.A.	N.A.
303 British	77154	71154	78154	N.A.	N.A.	75154	N.A.	N.A.	N.A.	N.A.
30/338 Winchester Mag	77394	71394	78394	36394	38394	75394	56394	55394	58394	99407
30-378 Weatherby Mag	77547	71547	78547	N.A.	N.A.	75547	N.A.	N.A.	N.A.	N.A.
338 Lapua Mag	77594	71594	78594	36594	38594	75594	56594	55594	58594	99533

# Handgun Die Sets In Titanium Carbide

Titanium carbide differs considerably from tungsten carbides, and is the ideal material for lubeless resizing of cartridge cases. The difference is in the microscopic structure. Tungsten carbide if viewed under a microscope, appears as sharp irregular micrograins resembling chunks of coal or quartz, and regardless of how well the surface is finished, its inherent structure remains the same. Titanium carbide

micrograins on the other hand, appear smooth and rounded, resembling the rounded stones you might find in a stream bed.

Titanium carbide has the highest hardness of any readily available carbide, and those smooth rounded micrograins present a slippery, non-galling surface that is simply unattainable with other carbides.

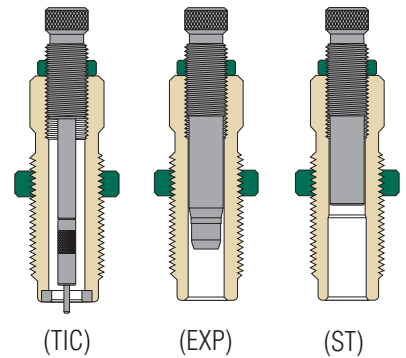

**TIC Die Sets . . . . . \$99.00 (9MM Luger and 500 S&W add \$16.50)**  
**TIC Sizer Die . . . . . 73.50 (9MM Luger and 500 S&W add \$16.50)**

## Titanium Carbide Die Sets

Cartridge	Titanium Carbide Die Set	Titanium Carbide Sizer Die	Pro-Series Die Set	Pro-Series Seat Die	Taper Crimp Die	Profile Crimp Die	Extended Shellholder	Trim Die
32 ACP	88220	87220	89220	94220	85220	N.A.	22E	N.A.
32 Smith & Wesson Long	88158	87162	N.A.	N.A.	85158	86158	10E	83158
32 H & R Magnum	88261	87162	89261	N.A.	N.A.	86261	10E	83161
32 S & W Long/32 H & R Mag	88162	87162	89162	94162	85162	86162	10E	N.A.
380 Auto	88170	87170	89170	94170	85170	N.A.	10E	83170
9MM Luger	88172	87172	89172	94172	85172	N.A.	13E	83172
38 Special	88183	87282	N.A.	N.A.	N.A.	N.A.	12E	83183
357 Magnum	88182	87282	N.A.	N.A.	N.A.	86182	12E	83182
38 Spec/357 Mag	88282	87282	89282	94282	85282	86282	12E	N.A.
38 Super Auto	88271	87271	89271	94271	85271	N.A.	5E	83271
40 Smith & Wesson	88272	87253	89272	94272	85272	N.A.	5E	83272
10MM Auto	88520	87253	89520	94520	85520	N.A.	5E	83520
40 S&W/10MM Auto	88253	87253	89253	94253	85253	N.A.	5E	N.A.
41 Magnum	88185	87185	89185	94185	85185	86185	21E	83185
44 Special	88187	87286	N.A.	N.A.	N.A.	N.A.	19E	83187
44 Magnum	88186	87286	N.A.	N.A.	N.A.	86186	19E	83186
44 Spec/44 Mag	88286	87286	89286	94286	85286	86286	19E	N.A.
45 GAP	88305	87189	89305	94189	85305	N.A.	1E	N.A.
45 ACP	88189	87189	89189	94189	85189	N.A.	1E	83189
45 Auto Rim	88189	87189	89190	94189	85189	86189	17E	83189
45 Colt/454 Casull	88191	87191	89191	94191	85191	86191	23E	83191
460 S&W Magnum	88278	87191	89278	94278	N.A.	86278	23E	N.A.
500 S&W Magnum	88291	87291	89291	94291	N.A.	86291	N.A.	N.A.

## Pro Series Die Sets In Titanium Carbide

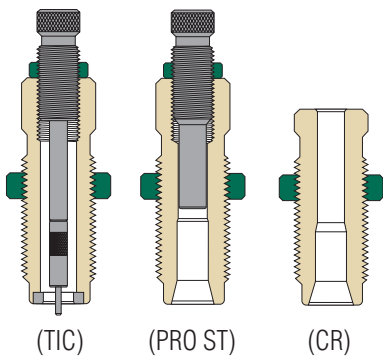

The "Pro Series", for use in progressive reloading machines, is a specially prepared three (3) die set. Since the most popular machines do not make use of an expander

die, it has been eliminated in the new "Pro Series" sets. The sizing die is the extraordinary Redding Titanium Carbide, complete with a decapping unit. A superior crimp can be accomplished if it is done in a separate operation from the bullet seating. For this reason the "Pro Series" bullet seating die is designed for bullet seating only, with no crimping feature. Our Profile Crimp die is supplied for the final crimping. For cartridges that headspace on the case mouth, a Taper Crimp die is substituted. All dies in the set have a special large radius at the mouth for easy case entry, a necessary feature for progressive machines. Refer to the die chart above for ordering numbers . . . \$114.00 (9MM Luger and 500 S&W . . . add 16.50)



*"As a custom Pistolsmith I know how important it is to have quality reloads for highly tuned pistols to perform flawlessly. That's why I always recommend Redding reloading equipment to my clients."*

**Jack Weigand**  
[www.jackweigand.com](http://www.jackweigand.com)



# Competition Pro Series Die Sets In Titanium Carbide

## Features our Competition Bullet Seating Die (see page 1)

The "Competition Pro Series" three (3) die set is designed for use in progressive reloading machines by reloaders seeking the most advanced bullet alignment available. This deluxe version of our Pro Series die set also contains our Titanium Carbide sizing die and Profile Crimp Die. (Taper crimp die for cartridges that headspace on the case mouth.)

No expander die is included, as the most popular progressive machines expand the case mouth at the powder metering station. The Competition Seating Die and crimping die have a special large radius at the mouth for easy case entry. Refer to the die chart for ordering numbers . . . . \$178.50 (9MM Luger and 500 S&W . . . add 16.50)

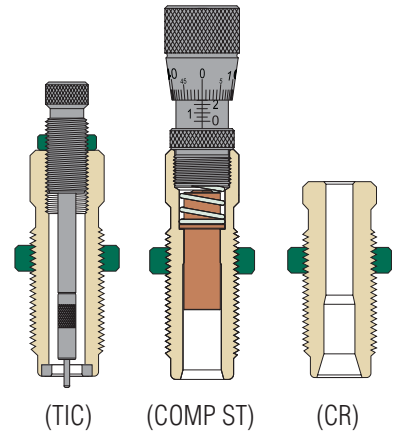

Cartridge	Competition Pro-Series Die Set	Titanium Carbide Sizing Die	Competition Seating Die	Taper Crimp Die	Profile Crimp Die	Trim Die
9MM Luger	58172	87172	55172	85172	N.A.	83172
38 Special/357 Magnum	58282	87282	55282	85282	86282	N.A.
38 Super Auto	58271	87271	55271	85271	N.A.	83271
40 S&W/10MM Auto	58253	87253	55253	85253	N.A.	N.A.
41 Magnum	58185	87185	55185	85185	86185	83185
44 Special/44 Magnum	58286	87286	55286	85286	86286	N.A.
45 GAP	58305	87189	55189	85305	N.A.	N.A.
45 ACP	58189	87189	55189	85189	N.A.	83189
45 Auto Rim	58190	87189	55189	85189	86189	83189
45 Colt/454 Casull	58191	87191	55191	85191	86191	83191
460 S&W Magnum	58278	87191	55278	N.A.	86278	N.A.
500 S&W Magnum	58291	87291	55291	N.A.	86291	N.A.

# Competition Pro Series Die Sets Non Carbide For Traditional Cartridges

## Features our Competition Bullet Seating Die (see page 1)

These "Competition Pro Series" three (3) die sets are also designed for use in progressive reloading machines by reloaders seeking the most advanced bullet alignment available. Since carbide dies are not available for certain cartridges, the sizing die is Redding's unique 91000 series in heat-treated steel. (See F.A.Q. below.) To apply a tighter, more uniform roll type crimp, our popular Profile Crimp Die is used. No expander die is included, as most popular progressive machines expand the case mouth at the powder metering station. Refer to the die chart below for ordering numbers . . . . . \$147.00

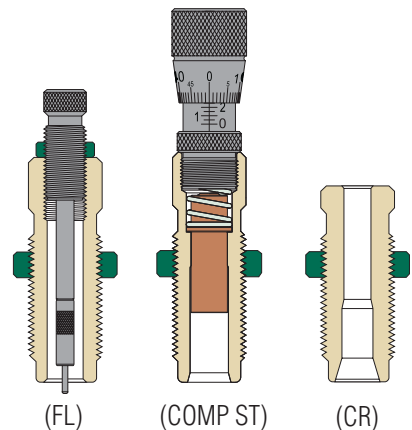

Cartridge	Competition Pro Series Die Set	Competition Seating Die	Sizing Die	Expander Die	Profile Crimp Die	Trim Die
38-40 Winchester	58366	55366	91366	93366	86366	83366
38-55 Winchester	58365	55365	91365	93365	86365	83365
40-65 Winchester	58465	55465	91465	93465	86465	83465
44-40 Winchester	58188	55188	91188	93188	86188	N.A.
45-70 Government	58209	55209	91209	93209	86209	83209

### Frequently Asked Question

**Q:** Why are carbide sizing dies not made for certain bottleneck and/or tapered cartridges?

**A:** While it is possible to produce carbide dies for tapered cartridges, the cost would be nearly prohibitive. Due to the tapered contact surfaces between the die and cartridge case, lubrication is still required. Thus, the advantage of carbide is lost. Any advantage in die life is negated by the increased cost.

# Rifle & Handgun Die Sets

*The quality and accuracy of your reloaded ammunition depends largely on the quality of the equipment you use to assemble it.*

Your choice of reloading dies should not be a casual one. Your dies literally shape the quality and function of your reloads. Because they are so important, we give them a lot of attention.

- We use the finest alloy steels obtainable.
- Our dies are machined on Hardinge Super-Precision® lathes capable of holding the tightest tolerances in the industry.
- This allows us to guarantee that they will produce ammunition that will properly fit any standard (SAAMI) chamber, regardless of action type.
- To maintain tolerances and guarantee that your dies will last a lifetime, all Redding dies are heat treated in atmospherically controlled furnaces.
- Finally, your dies are hand polished for smooth, flawless functioning, go through final inspection, and are ultrasonically cleaned and packaged.
- The die box is a handy cartridge loading block and storage package. Inside is a spare decapping pin, hex wrench, and even a place for your shellholder!
- All Redding dies use the industry standard 7/8-14 threaded bodies.

On the pages that follow, you will find many products and design features that are uniquely Redding. Most of these products have evolved from listening to the needs and desires of our customers and helping them solve specific problems.

The design of our Profile Crimp Die is an example that came about from an attempt to help silhouette shooters solve the typical “half moon” crimp so prevalent with magnum handgun cartridges. Our solution to the problem not only solved the ugly, half crimp, but proved to tighten groups as well.

## Seating Dies With Taper Crimp

Reloading dies for handgun calibers that headspace on the case mouth are indicated with a ♦. The seating dies in these calibers are made with a taper crimp. All other calibers have the standard roll crimp. Recent tests have shown that seating the bullet to its proper depth and crimping as a separate operation will produce the best accuracy. See page 17 for additional information on crimping dies.

**Congratulations to Kyle Brown for his 1,000 yard World Record!**

**16-1/2 lb. gun - 10 shots - 4.2278”**

His reloading equipment consisted of Redding’s Type-S Full Bushing Die, Competition Seating Die and T-7 Turret Press.



*“Thanks a million, or should I say a thousand yards, for making world record products...AWESOME!” -Kyle Brown*

**“World Class Products for World Class Shooters”**

## Full Length Die Sets For Bottleneck Cases

Full length die sets for bottleneck cases contain two dies. The full length (FL) resizing die contains a decapping rod assembly with a neck expander (size button). The seating die (ST) includes bullet guide, built-in crimping ring and the proper seating plug.

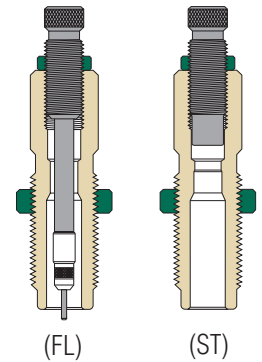

## Neck Die Sets For Bottleneck Cases

Neck die sets for bottleneck cases contain two dies. The neck (NK) resizing die contains a decapping rod assembly with a neck expander (size button). The seating die (ST) includes bullet guide, built in crimp ring and the proper seating plug.

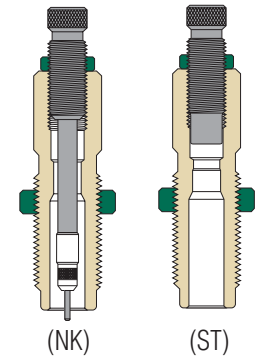

## Deluxe Die Sets For Bottleneck Cases

Deluxe die sets for bottleneck cases contain three dies. They are a special packaging of our full length die sets (described above) with the addition of a neck (NK) sizing die.

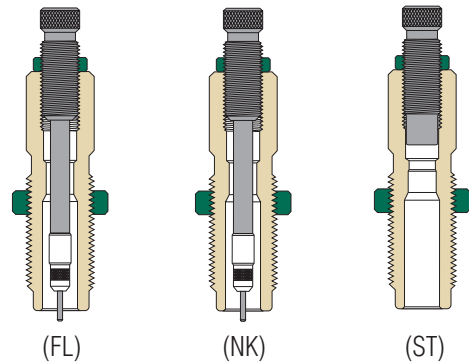

## Die Sets For Straight Wall Cases

Die sets for straight wall cases contain three dies. This is necessary because it is not possible to full length resize straight wall cases and expand the neck for proper bullet fit in one operation.

The full length (FL) resizing die contains a decapping rod assembly. The expander die (EXP) contains a neck expanding plug. The seating die (ST) includes bullet guide, built-in crimping ring and the proper seating plug.

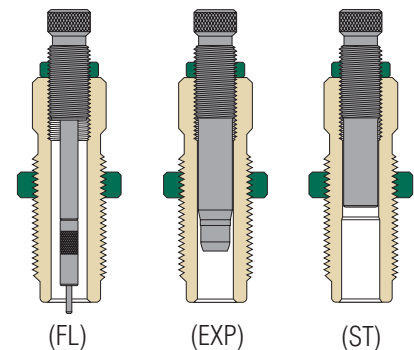

# SERIES A - Rifle & Handgun Dies

The Reloading die sets listed in this category represent the most popular dies that we produce. Series A is the lowest price category due to the high production quantities . . . . \$55.50



## SERIES A - Die Sets For Bottleneck Cases

Cartridge	Full Length Die Set \$55.50	Deluxe Die Set \$88.80	Neck Sizing Die \$37.80	Neck Die Sets \$55.50	Full Length Sizing Die \$37.80	Decap Rod Assembly \$13.80	Decap Rod \$9.00	Size Button \$8.10	Seating Die \$33.60	Seat Plug \$9.00	Form & Trim Die \$33.60
204 Ruger	80287	84287	81287	82287	91287	31203	01031	42203	92287	01085	83287
221 Remington Fireball	80101	84101	81101	82101	91101	32223	01032	42223	92101	01085	83101
22 Hornet	80102	84102	81102	82102	91102	32923	01032	39223	92102	01085	83102
220 Swift	80107	84107	81107	82107	91107	34223	01034	42223	92107	01083	83107
222 Remington	80109	84109	81109	82109	91109	32223	01032	42223	92109	01084	83109
22-250 Remington	80106	84106	81106	82106	91106	33223	01033	42223	92106	01083	83106
223 Remington	80111	84111	81111	82111	91111	33223	01033	42223	92111	01083	83111
243 WSSM	80270	84270	81270	82270	91270	32242	01032	42242	92270	01067	83270
243 Winchester	80114	84114	81114	82114	91114	33242	01033	42242	92114	01067	83114
6MM Remington	80115	84115	81115	82115	91115	34242	01034	42242	92115	01066	83115
25 WSSM	80263	84263	81263	82263	91263	32256	01032	42256	92263	01067	83263
25-06 Remington	80120	84120	81120	82120	91120	34256	01034	42256	92120	01067	83120
257 Roberts	80125	84125	81125	82125	91125	34256	01034	42256	92125	01066	83125
260 Remington	80531	84531	81531	82531	91531	33263	01033	42263	92531	01067	83531
6.5 x 55 Swedish	80132	84132	81132	82132	91132	34263	01034	42263	92132	01066	83132
270 Winchester	80135	84135	81135	82135	91135	25276	01025	41276	92135	01066	83135
270 WSM	80255	84255	81255	82255	91255	23276	01023	41276	92255	01067	83255
7MM-08 Remington	80139	84139	81139	82139	91139	23283	01023	41283	92139	01067	83139
7MM Remington Mag	80136	84136	81136	82136	91136	24283	01024	41283	92136	01067	83136
7MM x 57 Mauser	80138	84138	81138	82138	91138	24283	01024	41283	92138	01067	83138
280 Remington (7MM Exp. Rem.)	80142	84142	81142	82142	91142	25283	01025	41283	92142	01067	83142
30-30 Winchester	80146	84146	81146	82146	91146	23307	01023	41307	92146	01080	83146
30-06 Springfield	80148	84148	81148	82148	91148	24307	01024	41307	92148	01080	83148
300 Remington Ultra Mag	80288	84288	81288	82288	91288	25307	01025	41307	92288	01080	83288
300 WSM	80223	84223	81223	82223	91223	23307	01023	41307	92223	01080	83223
300 Winchester Mag	80153	84153	81153	82153	91153	25307	01025	41307	92153	01079	83153
300 Weatherby Mag	80252	84252	81252	82252	91252	25307	01025	41307	92252	01080	83252
308 Winchester/307 Winchester	80155	84155	81155	82155	91155	23307	01023	41307	92155	01080	83155
8MM x 57 Mauser	80159	84159	81159	82159	91159	24322	01024	41322	92159	01080	83159
338 Winchester Mag	80163	84163	81163	82163	91163	24336	01024	41336	92163	01063	83163
375 H & H Magnum	80169	84169	81169	82169	91169	25373	01025	41373	92169	01081	83169

## SERIES A - Die Sets For Straight Wall Cases

Cartridge	Three Die Set \$55.50	Sizing Die \$30.00	Decap Rod Assembly \$13.80	Seating Die \$28.50	Seat Plug \$9.00	Expander Die \$21.00	Expander \$12.00	Profile Crimp \$30.00	Taper Crimp \$30.00	Trim Die \$33.60
30 M1 Carbine ♦	80180	91180	22097	92180 ♦	01069RN	93180	95307	N.A.	85180	83180
32 Smith & Wesson Long	80158	91158	22097	92158	01073WC	93158	93310	86158	85158	83158
32 H & R Magnum	80161	91161	22097	92161	01069SWC	93161	93310	86261	N.A.	83161
32 S & W Long/32 H & R Mag	80162	91162	22097	92162	01073SWC	93162	93310	86162	85162	N.A.
9MM Luger ♦	80172	91172	22097	92172 ♦	01072RN	93172	91354	N.A.	85172	83172
38 Special	80183	91183	22097	92183	01071SWC	93183	94356	N.A.	N.A.	83183
357 Magnum	80182	91182	22097	92182	01071SWC	93182	94356	86182	N.A.	83182
38 Spec/357 Mag	80184	91184	22097	92184	01071SWC	93184	94356	86282	85282	N.A.
40 Smith & Wesson ♦	80272	91272	22097	92272 ♦	01092SWC	93272	92399	N.A.	85272	83272
10MM Auto ♦	80520	91520	22097	92520 ♦	01087SWC	93520	93399	N.A.	85520	83520
40 S & W/10MM Auto ♦	80253	91253	22097	92253 ♦	01092SWC	93253	92399	N.A.	85253	N.A.
44 Special	80187	91187	21097	92187	01074SWC	93187	94428	N.A.	N.A.	83187
44 Magnum	80186	91186	21097	92186	01074SWC	93186	94428	86186	N.A.	83186
44 Spec/44 Mag	80194	91194	21097	92194	01074SWC	93194	94428	86286	85286	N.A.
44-40 Winchester	80188	91188	21097	92188	01074RN	93188	95426	86188	N.A.	N.A.
45 ACP/45 Auto Rim ♦	80189	91189	21097	92189 ♦	01075RN	93189	93450	86189+	85189	83189
45 Colt/454 Casull	80191	91191	21097	92191	01076SWC	93191	95450	86191	85191	83191

♦ Denotes taper crimp seating die.

+Profile Crimp for 45 Auto Rim only



## SERIES B - Rifle & Handgun Dies

Reloading dies in this Series are slightly less popular or are more costly to produce than our Series A die sets . . . . . \$76.50

## SERIES B - Die Sets For Bottleneck Cases

Cartridge	Full Length Die Set \$76.50	Deluxe Die Set \$121.50	Neck Sizing Die \$51.00	Neck Die Sets \$76.50	Full Length Sizing Die \$51.00	Decap Rod Assembly \$13.80	Decap Rod \$9.00	Size Button \$8.10	Seating Die \$46.50	Seat Plug \$9.00	Form & Trim Die \$46.50
17 Remington	80217	84217	81217	82217	91217	31171	01031	42171	92217	01085	83217
<b>NEW</b> 17 Remington Fireball	80204	84204	81204	82204	91204	26171	01026	42171	92204	01085	N.A.
218 Bee	80200	84200	81200	82200	91200	32923	01032	39223	92200	01085	83200
22 K-Hornet	80362	84362	81362	82362	91362	32923	01032	39223	92362	01085	83362
22 B.R. Remington	80316	84316	81316	82316	91316	32223	01032	42223	92316	01083	83316
22 P.P.C. USA	80318	84318	81318	82318	91318	32223	01032	42223	92318	01084	83318
223 WSSM	80295	84295	81295	82295	91295	32223	01032	42223	92295	01084	83295
6MM B.R. Rem (Norma BR)	80317	84317	81317	82317	91317	32242 *	01032	42242 *	92317	01067	83317
6MM P.P.C. USA	80319	84319	81319	82319	91319	32842	01032	19242	92319	01067	83319
25-20 Winchester	80218	84218	81218	82218	91218	32956	01032	39256	92218	01066	83218
250 Savage (250-3000)	80122	84122	81122	82122	91122	33256	01033	42256	92122	01067	83122
256 Winchester Mag	80233	84233	81233	82233	91233	32956	01032	39256	92233	01066	83233
257 Weatherby Mag	80226	84226	81226	82226	91226	35256	01035	42256	92226	01066	83226
264 Winchester Mag	80127	84127	81127	82127	91127	34263	01034	42263	92127	01062	83127
6.5MM/284 Winchester (Norma)	80415	84415	81415	82415	91415	34263	01034	42263	92415	01067	83415
270 Weatherby Mag	80234	84234	81234	82234	91234	25276	01025	41276	92234	01066	83234
6.8MM Remington SPC	80259	84259	81259	82259	91259	22276	01022	41276	92259	01067	83259
7MM B.R. Remington	80241	84241	81241	82241	91241	22283	01022	41283	92241	01067	83241
7MM Rem SA UM	80280	84280	81280	82280	91280	23283	01023	41283	92280	01080	83280
7MM WSM	80265	84265	81265	82265	91265	23283	01023	41283	92265	01067	83265
7MM Remington Ultra Mag	80923	84923	81923	82923	91923	25283	01025	41283	92923	01067	83923
7MM STW (Shooting Times)	80544	84544	81544	82544	91544	25283*	01025	41283*	92544	01062	83544
7MM TCU	80242	84242	81242	82242	91242	23883	01023	16283	92242	01067	83242
7.62MM x 39	80129	84129	81129	82129	91129	22307	01022	41307	92129	01067	83129
284 Winchester	80141	84141	81141	82141	91141	24283	01024	41283	92141	01067	83141
7MM Weatherby Mag	80237	84237	81237	82237	91237	25283	01025	41283	92237	01067	83237
7.62MM Russian (7.62MM x 54R)	80290	N.A.	N.A.	N.A.	91290	23307	01023	41307	92290	01080	N.A.
<b>NEW</b> 30 TC	80236	84236	81236	82236	91236	23307	01023	41307	92236	01079	N.A.
300 Savage	80151	84151	81151	82151	91151	23307	01023	41307	92151	01079	83151
<b>NEW</b> 308 Marlin Express	80294	84294	81294	82294	91294	23307	01023	41307	92294	01079	N.A.
300 H & H Magnum	80150	N.A.	N.A.	N.A.	91150	25307	01025	41307	92150	01080	83150
308 Norma Mag	80258	84258	81258	82258	91258	25307	01025	41307	92258	01079	83258
300 Rem SA UM	80275	84275	81275	82275	91275	23307	01023	41307	92275	01080	83275
303 British	80154	84154	81154	82154	91154	24310	01024	41310	92154	01079	83154
32-40 Winchester	80225	N.A.	N.A.	N.A.	91225	23320	01023	41320	92225	01080	N.A.
325 WSM	80202	84202	81202	82202	91202	23822 *	01023	16322 *	92202	01080	N.A.
338 Federal	80264	84264	81264	82264	91264	23837 *	01023	16336 *	92264	01080	N.A.
338 Remington Ultra Mag	80874	84874	81874	82874	91874	25336	01025	41336	92874	01063	83874
340 Weatherby Mag	80256	84256	81256	82256	91256	25336 *	01025	41336 *	92256	01063	N.A.
35 Remington	80165	84165	81165	82165	91165	23356	01023	41356	92165	01081	83165
35 Whelen	80215	84215	81215	82215	91215	24856 *	01024	16356 *	92215	01081	83215
350 Remington Mag	80266	84266	81266	82266	91266	24356	01024	41356	92266	01082	83266
358 Winchester/356 Winchester	80227	84227	81227	82227	91227	23856	01023	16356	92227	01081	83227
<b>NEW</b> 375 Ruger	80269	84269	81269	82269	91269	25373	01025	41373	92269	01081	N.A.
45-70 Govt.			81209	82209							

— SEE BELOW FOR OTHER 45-70 DIES —

## SERIES B - Die Sets For Straight Wall Cases

Cartridge	Three Die Set \$76.50	Sizing Die \$40.50	Decap Rod Assembly \$13.80	Seating Die \$39.90	Seat Plug \$9.00	Expander Die \$28.50	Expander \$12.00	Profile Crimp \$37.50	Taper Crimp \$37.50	Trim Die \$46.50
32 ACP	80220	91220	22097	92220	01070RN	93220	90310	N.A.	85220	N.A.
32-20 Winchester	80281	91281	22097	92281	01069RN	93281	95311	86281	N.A.	83281
380 Auto ♦	80170	91170	22097	92170	01078RN	93170	91354	N.A.	85170	83170
38 Super Auto	80271	91271	22097	92271	01072RN	93271	93354	N.A.	85271	83271
41 Magnum	80185	91185	22097	92185	01077SWC	93185	95409	86185	85185	83185
375 Winchester	80206	91206	23097	92206	01081	93206	99374	N.A.	N.A.	N.A.
45-70 U.S. Govt.	80209	91209	27097	92209	01065	93209	99457	86209	N.A.	83209
458 Winchester Mag	80208	91208	28097	92208	01065	93208	99457	86208	N.A.	83208
460 S&W Magnum	80278	91278	27097	92278	01096	93278	95450	86278	N.A.	N.A.
500 S&W Magnum	80291	91291	21097	92291	01094	93291	96498	86291	N.A.	N.A.

# SERIES C - Rifle & Handgun Dies

Series C dies are less popular than the die sets listed in Series A & B.  
This listing also contains many popular wildcats . . . . \$99.00



## SERIES C - Die Sets For Bottleneck Cases

Cartridge	Full Length Die Set \$99.00	Deluxe Die Set \$156.00	Neck Sizing Die \$64.50	Neck Die Sets \$99.00	Full Length Sizing Die \$64.50	Decap Rod Assembly \$13.80	Decap Rod \$9.00	Size Button \$8.10	Seating Die \$57.00	Seat Plug \$9.00	Form & Trim Die \$57.00
20 Tactical	80660	84660	81660	82660	91660	31203	01031	42203	92660	01085	83660
219 Zipper	80360	N.A.	N.A.	N.A.	91360	33223	01033	42223	92360	01083	83360
222 Remington Mag	80203	84203	81203	82203	91203	33223	01033	42223	92203	01083	83203
225 Winchester	80239	84239	81239	82239	91239	33223	01033	42223	92239	01083	83239
22-250 Improved 40°	80406	84406	81406	82406	91406	33223	01033	42223	92406	01083	83406
22 Savage H.P. (5.6MM x 52R)	80338	N.A.	N.A.	N.A.	91338	33227	01033	42227	92338	01084	83338
6MM TCU	80245	84245	81245	82245	91245	33842 *	01033	19242 *	92245	01066	83245
6MM/223 Rem (6MM x 45)	80312	84312	81312	82312	91312	33842 *	01033	19242 *	92312	01066	83312
6MM/284 Winchester	80414	84414	81414	82414	91414	34242	01034	42242	92414	01066	83414
240 Weatherby Mag	80232	84232	81232	82232	91232	34242	01034	42242	92232	01067	83232
243 Winchester Improved 40°	80420	84420	81420	82420	91420	33242	01033	42242	92420	01067	83420
257 Roberts Improved 40°	80322	84322	81322	82322	91322	34256	01034	42256	92322	01066	83322
6.5-06 (A-SQUARE)	80378	84378	81378	82378	91378	34263	01034	42263	92378	01067	83378
280 Remington Improved 40°	80428	84428	81428	82428	91428	25283	01025	41283	92428	01067	83428
7-30 Waters	80230	84230	81230	82230	91230	23283	01023	41283	92230	01067	83230
7MM x 64 Brenneke	80340	N.A.	N.A.	N.A.	91340	24283	01024	41283	92340	01062	83340
7.5 x 55 Swiss (K-31)	80235	84235	81235	82235	91235	24307	01024	41307	92235	01079	83235
30-20 TC	80254	84254	81254	82254	91254	22007	01022	40307	92254	01066	83254
30-06 Improved 40°	80324	84324	81324	82324	91324	24307	01024	41307	92324	01080	83324
30-40 Krag	80147	84147	81147	82147	91147	24307	01024	41307	92147	01080	83147
30/338 Winchester Mag	80394	84394	81394	82394	91394	24307	01024	41307	92394	01063	83394
30-378 Weatherby Mag	80547	84547	81547	82547	91547	25307	01025	41307	92547	01080	83547
303 Savage	80296	N.A.	N.A.	N.A.	91296	23307	01023	41307	92296	01080	N.A.
32 Remington	80332	N.A.	N.A.	N.A.	91332	23820 *	01023	16320 *	92332	01080	N.A.
32 Winchester Spec.	80157	84157	81157	82157	91157	23320	01023	41320	92157	01080	83157
338-06 (A-SQUARE)	80328	84328	81328	82328	91328	24837 *	01024	16336 *	92328	01063	83328
338 Lapua Mag	80594	84594	81594	82594	91594	25336	01025	41336	92594	01063	83594
348 Winchester	80336	N.A.	N.A.	N.A.	91336	24347	01024	41347	92336	01081	83336
35 Winchester	80335	N.A.	N.A.	N.A.	91335	24356	01024	41356	92335	01081	N.A.
358 Norma Mag	80210	N.A.	N.A.	N.A.	91210	24356	01024	41356	92210	01081	83210
9MM x 57 Mauser	80357	N.A.	N.A.	N.A.	91357	24356	01024	41356	92357	01081	83357
375 Remington Ultra Mag	80925	84925	81925	82925	91925	25373	01025	41373	92925	01081	83925
416 Remington Magnum	80442	84442	81442	82442	91442	25414	01025	41414	92442	01064	83442

## SERIES C - Die Sets For Straight Wall Cases

Cartridge	Three Die Set \$99.00	Sizing Die \$49.50	Decap Rod Assembly \$13.80	Seating Die \$48.00	Seat Plug \$9.00	Expander Die \$34.50	Expander \$12.00	Profile Crimp \$45.00	Taper Crimp \$45.00	Trim Die \$57.00
30 Mauser (7.62 x 25 Tokarev)	80251	91251	22097	92251	01069RN	93251	93307	N.A.	N.A.	83251
357 SIG ♦	80434	91434	22097	92434 ♦	01072SWC	93434	91354	N.A.	85434	83434
38-55 Winchester & Ballard	80365	91365	23097	92365	01081	93365	99374	86365	N.A.	83365
38-40 Winchester	80366	91366	22097	92366	01071RN	93366	95399	86366	N.A.	83366
40-65 Winchester	80465	91465	23097	92465	01081	93465	94407	86465	N.A.	83465
41 Long Colt	80370	91370	22097	92370	01077RN	93370	94385	N.A.	N.A.	N.A.
44 Russian	80372	91372	21097	92372	01074RN	93372	93428	N.A.	N.A.	83372
444 Marlin	80207	91207	28097	92207	01068FP	93207	97428	N.A.	N.A.	83207
450 Marlin	80350	91350	27097	92350	01065	93350	99457	N.A.	N.A.	N.A.
480 Ruger/475 Linebaugh	80380	91380	21097	92380	01093	93380	94473	86380	N.A.	N.A.

♦ Denotes taper crimp seating die.



## SERIES D - Rifle & Handgun Dies

Series D die sets represent obsolete cartridges, wildcats, etc., essentially custom stock. We attempt to maintain inventory in limited quantities. Consult us for your specific needs . . . \$111.00

## SERIES D - Die Sets For Bottleneck Cases

Cartridge	Full Length Die Set	Deluxe Die Set	Neck Sizing Die	Neck Die Sets	Full Length Sizing Die	Decap Rod Assembly	Decap Rod	Size Button	Seating Die	Seat Plug	Form & Trim Die
	\$111.00	\$177.00	\$72.60	\$111.00	\$72.60	\$13.80	\$9.00	\$8.10	\$63.00	\$9.00	\$63.00
17 MACH IV	80504	84504	81504	82504	91504	26171	01026	42171	92504	01085	83504
219 Donaldson Wasp	80403	84403	81403	82403	91403	33223	01033	42223	92403	01083	83403
219 Don. Wasp Short (original)	80402	84402	81402	82402	91402	33223	01033	42223	92402	01083	83402
223 Remington Improved 40°	80907	84907	81907	82907	91907	33223	01033	42223	92907	01083	N.A.
224 Weatherby Mag	80212	84212	81212	82212	91212	37223	01033	42223	92212	01084	83212
5.7 x 28	80477	84477	81477	82477	91477	37923	01037	39223	92477	01085	N.A.
6MM Remington Improved 40°	80421	84421	81421	82421	91421	34242	01034	42242	92421	01066	83421
6MM/22-250 Remington	80516	84516	81516	82516	91516	33842	01033	19242	92516	01067	83516
6mmXC	80745	84745	81745	82745	91745	33842	01033	19242	92745	01067	N.A.
25-35 Winchester	80221	84221	81221	82221	91221	32566	01033	42256	92221	01067	83221
25 Remington	80325	N.A.	N.A.	N.A.	91325	33256	01033	42256	92325	01067	83325
250 Savage Improved 40°	80416	84416	81416	82416	91416	33256	01033	42256	92416	01067	83416
25/284 Winchester	80417	84417	81417	82417	91417	34256	01034	42256	92417	01067	83417
25-06 Remington Improved 40°	80422	84422	81422	82422	91422	34256	01034	42256	92422	01067	N.A.
<b>NEW</b> 6.5 GRENDÉL™	80478	N.A.	N.A.	N.A.	91478	32263	01032	42263	92478	01067	N.A.
6.5MM x 50 Japanese	80224	84224	81224	82224	91224	33263	01033	42263	92224	01067	83224
6.5MM x 54 Mannlicher	80277	84277	81277	82277	91277	33263	01033	42263	92277	01062	83277
6.5MM x 57 Mauser	80228	84228	81228	82228	91228	34263	01034	42263	92228	01067	83228
6.5MM Remington Mag	80231	84231	81231	82231	91231	34263	01034	42263	92231	01067	83231
7MM-08 Rem. Improved 40°	80430	84430	81430	82430	91430	32823	01023	41283	92430	01080	83430
7MM x 57 Improved 40°	80427	84427	81427	82427	91427	24283	01024	41283	92427	01067	83427
7MM/300 Weatherby Mag	80384	84384	81384	82384	91384	25283	01025	41283	92384	01067	83384
300/221 Remington	80432	84432	81432	82432	91432	22807 *	01022	16307 *	92432	01079	83432
30 Remington	80392	N.A.	N.A.	N.A.	91392	23307	01023	41307	92392	01080	N.A.
30-30 Improved 40°	80431	84431	81431	82431	91431	23307	01023	41307	92431	01080	83431
7.65MM x 53 Mauser (Belgian)	80243	84243	81243	82243	91243	23310	01023	41310	92243	01063	83243
7.7MM x 58 Japanese	80244	84244	81244	82244	91244	24310	01024	41310	92244	01080	83244
33 Winchester	80205	N.A.	N.A.	N.A.	91205	23336	01023	41336	92205	01080	83205
338-06 Improved 40°	80437	84437	81437	82437	91437	24837 *	01024	16336 *	92437	01063	83437
338-378 Weatherby Mag	80527	84527	81527	82527	91527	25336	01025	41336	92527	01063	83527
35 Whelen Improved 40°	80438	84438	81438	82438	91438	24856 *	01024	16356 *	92438	01081	83438
375/444 Marlin	80475	84475	81475	82475	91475	24373	01024	41373	92475	01080	N.A.
375 H & H Improved 40°	80440	84440	81440	82440	91440	25373	01025	41373	92440	01081	N.A.
375 Weatherby Mag	80468	N.A.	N.A.	N.A.	91468	25373	01025	41373	92468	01081	N.A.
378 Weatherby Mag	80469	84469	81469	82469	91469	25373	01025	41373	92469	01081	N.A.
9.3MM x 62 Mauser	80345	N.A.	N.A.	N.A.	91345	24364	01024	41364	92345	01064	83345
<b>NEW</b> 9.3MM x 74R	80346	N.A.	N.A.	N.A.	91346	25364	01025	41364	92346	01064	N.A.
416 Weatherby Mag	80492	N.A.	N.A.	N.A.	91492	25414	01025	41414	92492	01064	N.A.
460 Weatherby Mag	80480	84480	81480	82480	91480	30456	01030	41456	92480	01065	N.A.
<b>NEW</b> 470 Nitro Express	80481	N.A.	N.A.	N.A.	91481	29472	01029	41472	92481	01100	N.A.

## SERIES D - Die Sets For Straight Wall Cases

Cartridge	Three Die Set	Sizing Die	Decap Rod Assembly	Seating Die	Seat Plug	Expander Die	Expander	Profile Crimp	Taper Crimp	Trim Die
	\$111.00	\$55.50	\$13.80	\$54.00	\$9.00	\$39.00	\$12.00	\$51.00	\$51.00	\$63.00
30 Luger	80250	91250	22097	92250	01073RN	93250	92307	N.A.	N.A.	83250
351 Winchester S.L.	80462	91462	22097	92462	01079	93462	96350	N.A.	N.A.	N.A.
38 Smith & Wesson	80303	91303	22097	92303	01072RN	93303	92356	N.A.	N.A.	83303
38-56 Winchester	80463	91463	23373	92463	01081	93463	99374	N.A.	N.A.	83463
9mm Makarov ♦	80804	91804	22097	92804	♦ 01072RN	93804	91363	N.A.	85804	83804
40 SUPER ♦	80677	91677	22097	92677	♦ 01092SWC	93677	93399	N.A.	85677	N.A.
40-82 Winchester	80482	91482	24404	92482	01081	93482	96405	N.A.	N.A.	83482
401 Winchester S.L.	80471	91471	22097	92471	01081	93471	96405	N.A.	N.A.	83471
405 Winchester	80473	91473	25097	92473	01081	93473	97409	N.A.	N.A.	N.A.
45 Winchester Mag ♦	80445	91445	21097	92445	♦ 01076RN	93445	94450	N.A.	85445	83445
455 Webley	80375	91375	21097	92375	01075RN	93375	92454EXP	N.A.	N.A.	83375
<b>NEW</b> 45-60 Winchester	80570	91570	21097	92297	01065	93570	99457	86570	N.A.	83570
45-90 Winchester	80476	91476	28097	92476	01065	93476	99457	N.A.	N.A.	83476
458 Lott	80460	91460	30097	92460	01065	93460	99457	N.A.	N.A.	83460

\*Denotes tapered size button.

## "E-Z Feed" Shellholders



New tapered design allows easy case entry. Machined to very close tolerances to fit your cases perfectly and eliminate potential problems. The universal design fits all popular presses. Only Redding shellholders are heat treated and have outside knurling to make them easy to handle and change. See Reference Charts on pages 16, 17 & 18 for proper size. **ITEM NO. 110XX** (specify shellholder #) **\$10.35**



## "E-Z Feed" Shellholder Sets

This set consists of the six most popular shellholders with the new "E-Z Feed" design. Shellholders - #1, #6, #10, #12, #18 & #19.

See Reference Charts on pages 16, 17 & 18 for shellholder usage.

**ITEM NO. 11900** ..... **\$54.00**

Shellholder storage box is available separately

**ITEM NO. 11699** ..... **2.70**



## Trim Dies

Redding trim dies allow you to file trim your cases without unnecessary resizing because they are made to chamber dimensions. Other manufacturers use sizing die dimensions, forcing you to full length resize when trimming. For case forming and necking brass down from another caliber, Redding trim dies can be the perfect intermediate step before full length resizing. Pistol trim dies require extended shellholders. Refer to die charts for available calibers and the extended shellholders required. See our case forming section on page 19.

Series A **\$ 33.60** Series B **\$ 46.50**  
Series C **57.00** Series D **63.00**

## Carbide Size Button Kits



Make inside neck sizing smoother and easier without lubrication. Now you can upgrade your die sets with a carbide size button kit.

Available for bottleneck cartridges 22 thru 338 cal. The carbide size button is free floating on the decap rod allowing it to self-center in the case neck. Kits contain: carbide size button, retainer and spare decapping pin.

**These kits also fit all Type-S dies \$30.00**

Kit No. 48223 .....22 cal.  
Kit No. 48242 .....6MM  
Kit No. 48256 .....25 cal.  
Kit No. 48263 .....6.5MM  
Kit No. 49276 .....270 cal.  
Kit No. 49283 .....7MM  
Kit No. 49307 .....30 cal.  
Kit No. 49337 .....338 cal.

See chart on pages 4 & 5 for Competition Neck Sizing Die Carbide Kit item numbers

## Taper Crimp Dies

Designed for handgun cartridges which headspace on the case mouth where conventional roll crimping is undesirable.



Also available for some revolver cartridges, for those who prefer the uniformity of a taper crimp.

Now available in the following rifle calibers: 223 Rem, 7.62MM x 39, 30-30, 308 Win, 30-06, 300 Win Mag, 300 Remington Ultra Mag

Series A **\$30.00** Series B **\$37.50**  
Series C **45.00** Series D **51.00**

## Profile Crimp Dies

These handgun cartridge crimp dies were designed for those who want the best possible crimp. Profile crimp dies provide a tighter, more uniform roll type crimp, and requires the bullet to be seated to the correct depth in a previous operation. These dies are not for cartridges that headspace on the case mouth.



Series A **\$30.00** Series B **\$37.50**  
Series C **45.00** Series D **51.00**

## Tapered Size Buttons



These long tapered expanders (size buttons) are made for expanding the necks of bottleneck cartridges up to the desired size.

Tapered size button only **\$ 16.50**

Decapping rod assembly with tapered size button, specify cartridge **\$ 24.00**

6mm...(17 to 6 mm) ..... NO. 19242  
25 cal...(22 to 25 cal.) ..... NO. 19256  
6.5mm...(22 to 6.5mm) ..... NO. 19263  
270 cal...(22 to .270) ..... NO. 16276  
7mm...(22 to 7mm) ..... NO. 16283  
30 cal...(6mm to 30 cal.) ..... NO. 16307  
8mm...(25 cal. to 8mm) ..... NO. 16322  
338 cal...(6.5 to .338) ..... NO. 16336  
35 cal...(7mm to 35 cal.) ..... NO. 16356  
375 cal...(30 cal. to .375 cal.) ... NO. 16373

## Neck Sizing Dies



These dies size only the necks of your bottleneck cases to prolong brass life and improve accuracy.

It is important to note that since these dies size only the neck and not the shoulder or body, fired cases should not be interchanged between rifles of the same caliber. Available individually, in our Neck Die Sets, and our Deluxe Die Sets.

Series A **\$ 37.80** Series B **\$ 51.00**  
Series C **64.50** Series D **72.60**

## Universal Decapping Dies

Decapping dies allow you to deprime and clean your cases prior to sizing.

The small decapping die will handle 22 thru 50 caliber cases with lengths up to 2.625". An optional decapping rod for this die is designed to work with all 17 caliber cases and will accommodate the small .060" flash holes found on the BR and PPC cases. For longer case lengths up to 3.0" use the large decapping die. Note: the large die will not accommodate a neck diameter of less than 25 caliber.

**ITEM 69100** Small decapping die ... **\$20.40**  
**ITEM 69200** Large decapping die ... **20.40**  
**ITEM 69250** Optional 17 caliber rod ... **10.80**  
Complete kit containing all of the above items  
**ITEM 69500** ..... **\$48.00**



# Competition Shellholder Sets

*Uniquely Redding!*

**Makes every die a custom die!**



## — Tech Talk — Create A "Custom Die" With A Simple Shellholder Change!

To maximize case life and the accuracy potential of your reloads, it's desirable to size fired cases the minimum amount that allows loaded cartridges to chamber freely.

Most hunters and many other shooters seeking smooth chambering reloads, full length size their cases each time. Since the interior dimensions of sizing dies are determined by the manufacturer, adjusting the shoulder setback is the only control a reloader has over how much a fired case is sized.

In the past, sizing die adjustment has been made through the trial and error method of rotating the die body in the reloading press. While acceptable results can be obtained using this method, precise adjustments are difficult at best.

Using this method, firm contact with the shellholder was not always possible. As a result, irregularities in brass hardness and thickness, as well as the uniformity and quantity of case lube affected shoulder setback. The resulting headspace variations created can adversely affect accuracy due to non-uniform primer/powder ignition. "Squaring" the die in the press is also precluded with this method of die adjustment.

To provide desirable shellholder-to-die contact during sizing, without excessively setting the case shoulder back, Redding now offers shellholders that are in increments of .002" thicker than the industry standard. The nominal thickness for industry standard shellholders is .125". (See dimension X on the shellholder diagram.) Our new Competition Shellholder Set includes five shellholders that are thicker than this in increments of .002". Therefore, the set includes shellholders that are marked +.002, +.004, +.006, +.008 and +.010, which is the amount the shellholder will decrease case to chamber headspace.

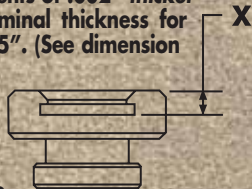

To select the proper shellholder for your particular firearm's chamber, start with the shellholder marked +.010. The shellholder should be adjusted to make firm contact with the bottom of the sizing die during the case sizing operation. Resize a case and try it (unprimed and empty) in the chamber of your firearm. If the empty case does not chamber or chambers with difficulty, switch to the shellholder marked +.008 and repeat the process. Stop at the shellholder that allows the firearm's action to close freely. Your cases are now being sized properly to fit your chamber with a minimum amount of headspace.

**Now you can control headspace.** The new Redding Competition Shellholders are packaged in five piece sets in .002" increments (+.002", +.004", +.006", +.008" and +.010"). Each shellholder has a distinct black oxide finish and is clearly marked to indicate the amount it will **decrease** case-to-chamber headspace. You can now easily adjust case-to-chamber headspace of your reloads with a simple shellholder change.

**ITEM NO. 116XX** (5 pc. set specify shellholder #) . . . . . **\$60.00**

Shellholder storage box available separately.

**ITEM NO. 11699** . . . . . **\$2.70**

Competition Shellholder Sets now available in the following sizes:

#1, 2, 4, 6, 7, 10, 12, 18 & 35

**NEW** Now available in sizes for the big Weatherbys (#18) and 338 Lapua (#35)!

## Special Small Base Body, Full Length & Type-S – Full Length Dies

Now available in the following calibers for firearms with custom chamberings that are tighter than SAAMI specifications.

**Note: For the ultimate shoulder bump control, use these dies with our new Competition Shellholders. See page 14 for details.**



### Small Base Body & Full Length Dies

Cartridge Group I	Small Base Body Die	Small Base Full Length
223 Remington . . . . .	74111	91323
260 Remington . . . . .	74531	N.A.
308 Winchester . . . . .	74155	91355
30-06 Springfield . . . . .	74148	N.A.
<b>Group II</b>	<b>\$51.00</b>	<b>\$57.00</b>
22 P.P.C. . . . .	N.A.	91301
6MM P.P.C. . . . .	74317	91211
6MM B.R. Remington . . . . .	74317	91201
6MM/284 Winchester . . . . .	74414	N.A.
6.5MM/248 Winchester . . . . .	74415	N.A.
284 Winchester . . . . .	74141	N.A.

### Small Base Type S - Full Length Dies

223 Remington . . . . .	77323	<b>\$82.50</b>
308 Winchester . . . . .	77355	<b>\$82.50</b>
6MM B.R. Remington . . . . .	77201	<b>\$82.50</b>
6MM P.P.C. . . . .	77211	<b>\$67.50</b>



Designed specifically for shooters who are seeking the utmost in accuracy from their handloads.

## Instant Indicator Headspace and Bullet Comparator

This instrument provides an extremely quick method for comparing bullets, seating depths, fired cases, sized cases, trim lengths and loaded ammunition for uniformity.

Easily perform any of the following tasks.

- Sort bullets for uniformity
- Sort cases fired in two or more rifles
- Sort sized cases for uniformity
- Set up sizing die correctly \*
- Compare sized cases to fired cases to determine the amount of headspace
- Check uniformity of shoulder bump
- Check bullet seating depth uniformity
- Sort loaded ammunition for uniformity
- Determine when cases need trimming
- Check trim length uniformity

Supplied with one bore diameter bushing, surface contactor, shoulder contactor, headspace gauge and complete instructions..

**“Instant Indicator” w/Dial Indicator ITEM NO. 27XXX . . . . \$144.00**  
**w/o Dial Indicator ITEM NO. 27XXX . . . . . 111.00**  
**1” Dial Indicator ITEM NO. 17999 . . . . . 36.00**

\*Tip – the easiest and most repeatable sizing die adjustment can be made with our new competition shellholders. See page 14.



Large  
1" x .001"  
dial indicator

Patent Pending

**Cartridge availability and ordering numbers** Note: The “Instant Indicator” may be used on a family of cartridges with the same shoulder angle.

Cartridge	Item No.	w/o Indicator	Cartridge	Item No.	w/o Indicator	Cartridge	Item No.	w/o Indicator
222 Rem . . . . .	27109	17109	6MM Remington . . . . .	27115	17115	7MM x 57 . . . . .	27138	17138
223 Rem . . . . .	27111	17111	257 Roberts . . . . .	27125	17125	7MM Rem Mag . . . . .	27136	17136
223 WSSM . . . . .	27295	17295	257 Rob Imp 40° . . . . .	27322	17322	7MM STW . . . . .	27544	17544
22-250 Rem . . . . .	27106	17106	25-06 Remington . . . . .	27120	17120	308 Winchester . . . . .	27155	17155
22-250 Rem Imp 40° . . . . .	27406	17406	260 Remington . . . . .	27531	17531	30-06 Springfield . . . . .	27148	17148
220 Swift . . . . .	27107	17107	6.5MM x 55 . . . . .	27132	17132	300 Rem SA UM . . . . .	27275	17275
243 Win . . . . .	27114	17114	6.5/284 Win . . . . .	27415	17415	300 WSM . . . . .	27223	17223
243 Win Imp 40° . . . . .	27420	17420	270 Win . . . . .	27135	17135	300 Win Mag . . . . .	27153	17153
243 WSSM . . . . .	27270	17270	280 Remington . . . . .	27142	17142	300 Wby Mag . . . . .	27252	17252
6MM P.P.C. . . . .	27319	17319	280 Rem Imp 40° . . . . .	27428	17428	300 Rem Ultra Mag . . . . .	27288	17288
6MM B.R. Rem . . . . .	27317	17317	7MM-08 Rem . . . . .	27139	17139	338 Win Mag . . . . .	27163	17163

## Custom Made Dies

Our Series “C” and “D” listings contain many obsolete and wildcat cartridges normally considered “custom” by other manufacturers. We try to maintain limited quantities of factory inventory on these. If you do not find the dies that you need after consulting the die caliber reference charts on pages 20 and 21, we can usually custom make them for you. Please keep in mind, the die reference chart is only a partial listing. We have made custom dies for hundreds of chamberings that are simply too numerous to list.

Some cartridges with a very unique design and/or unusual shoulder angle may require a tooling and engineering charge to partially cover our expense for making up special tooling. In the event such costs are required, they will be quoted separately. To get a firm price quote, send us your chamber reamer drawing, including all dimensions and the shoulder angle.

As an alternative, you can simply send us three (3) fired cases from your chamber for examination on our optical comparator. Package them carefully to prevent damage in transit, and do not forget to include clear instructions as to exactly what your needs are, i.e. dies to form the case, full length die set, neck sizing dies only, etc. Your fired cases will be returned upon request. Because of the nature of work involved in making custom dies, advance payment is required with the order. Please allow a minimum of 16 weeks for delivery after your order has been received.

- Custom Two Die Sets . . . . . \$ 145.50**
- w/optional tapered size button . . . . . \$ 153.00**
- Custom F.L. Sizer or Neck Sizer . . . . . \$ 94.50**
- w/optional tapered size button . . . . . \$ 102.00**
- Custom “Type S” Neck or F.L. Sizer . . . . . \$ 126.00**
- w/optional tapered size button . . . . . \$ 133.50**
- Custom “Type S” Neck Die Set . . . . . \$ 246.00**
- w/optional tapered size button . . . . . \$ 253.50**
- Custom Deluxe Die Set . . . . . \$ 229.50**
- w/optional tapered size button . . . . . \$ 237.00**
- Custom Three Die Set (straight wall cases) \$ 159.00**
- Custom Seating Die . . . . . \$ 82.50**
- Custom Taper Crimp Die or Body Die . . . . \$ 66.00**
- Custom Form Die . . . . . \$ 66.00**
- Custom Form and Trim Die . . . . . \$ 82.50**
- Special Price Group (\*) . . . . . \$ 159.00**
- Special Shell Holders (\*) . . . . . \$ 15.60**

# Die Caliber Reference Chart

Cartridge	Series	Shellholder	Trimmer Pilot
17 Remington	B	#10	17 Cal.
17 Ackley Hornet	Custom	#14	17 Cal.
17 Bumble Bee	Custom	#3	17 Cal.
17 Ackley Bee	Custom	#3	17 Cal.
17 Mach IV	D	#10	17 Cal.
17 Javelina	Custom	#10	17 Cal.
17 He Bee	Custom	#3	17 Cal.
17 P.P.C.	Custom	#12	17 Cal.
17/221 Remington	Custom	#10	17 Cal.
<b>NEW</b> 17 Remington Fireball	B	#10	17 Cal.
17/222 Remington	Custom	#10	17 Cal.
17/222 Remington Mag	Custom	#10	17 Cal.
17/223 Remington	Custom	#10	17 Cal.
17 B.R. Remington	Custom	#1	17 Cal.
<hr/>			
20 Vartarg	Custom	#10	20 Cal.
20 Tactical	C	#10	20 Cal.
204 Ruger	A	#10	20 Cal.
20 P.P.C.	Custom	#12	20 Cal.
20 B.R. Remington	Custom	#1	20 Cal.
<hr/>			
218 Bee	B	#3	22 Cal.
218 Mashburn Bee	Custom	#3	22 Cal.
219 Zipper	C	#2	22 Cal.
219 Zipper Improved 28°	Custom	#2	22 Cal.
219 Donaldson Wasp	D	#2	22 Cal.
219 Donaldson Wasp Short (Original)	D	#2	22 Cal.
22 Cheetah Mark I (40°)	Custom	#1	22 Cal.
22 Cheetah Mark II (28°)	Custom	#1	22 Cal.
22 Hornet	A	#14	22 Cal.
22 K-Hornet	B	#14	22 Cal.
22 Lovell 2R (22-3000 G&H)	Custom	#10	22 Cal.
22 B.R. Remington	B	#1	22 Cal.
22 Remington Jet	Custom	#12	22 Cal.
22 Dasher	Custom	#1	22 Cal.
22 P.P.C. USA	B	#12	22 Cal.
22 Waldog	Custom	#12	22 Cal.
22 Savage H.P. (5.6MM x 52R)	C	#2	22 Cal.
22 Wampus Kitty	Custom	#1	22 Cal.
22 ULA Honeybee	Custom	#1	22 Cal.
220 Swift	A	#4	22 Cal.
220 Swift Imp 40°	Custom	#4	22 Cal.
220 Swift Imp 32°	Custom	#4	22 Cal.
220 Russian (5.6MM x 39)	Custom	#12	22 Cal.
220 Weatherby Rocket	Custom	#4	22 Cal.
220 Wilson Arrow	Custom	#4	22 Cal.
220 Jaybird	Custom	#1	22 Cal.
22-250 Remington	A	#1	22 Cal.
22-250 Improved 40°	C	#1	22 Cal.
22-250 Improved 28°	Custom	#1	22 Cal.
22/240 Weatherby Mag	Custom	#1	22 Cal.
22/243 Winchester	Custom	#1	22 Cal.
22/243 Improved 40°	Custom	#1	22 Cal.
22/6MM Remington	Custom	#1	22 Cal.
22/6MM Improved 40°	Custom	#1	22 Cal.
22/243 Middlested 30°	Custom	#1	22 Cal.
22/284 Winchester	Custom	#1	22 Cal.
22/30-30 Winchester	Custom	#2	22 Cal.
22/30-30 Improved 40°	Custom	#2	22 Cal.
221 Remington Fireball	A	#10	22 Cal.
222 Remington	A	#10	22 Cal.
222 Remington Mag	C	#10	22 Cal.
223 Remington	A	#10	22 Cal.
223 Remington Improved 40°	D	#10	22 Cal.
223 WSSM	B	#6	22 Cal.
224 Clark	Custom	#1	22 Cal.
224 Weatherby Mag	D	#12	22 Cal.
225 Winchester	C	#4	22 Cal.
5.6 x 50 R Mag	Custom	#12	22 Cal.
5.6 x 57 RWS	Custom	#1	22 Cal.
5.7 x 28	D	#34	22 Cal.
5.7MM Johnson (22 Spitfire)	Custom	#22	22 Cal.
<hr/>			
240 Weatherby Mag	C	#1	6MM
240 Gibbs	Custom	#1	6MM
240 Coyote #2	Custom	#2	6MM
240 Page Super Pooper	Custom	#1	6MM
243 Winchester	A	#1	6MM
243 Winchester Improved 40°	C	#1	6MM
243 Improved 30°	Custom	#1	6MM
243 Catbird	Custom	#1	6MM
243 WSSM	A	#6	6MM
6mmXC	D	#1	6MM
6MM Bullberry	Custom	#2	6MM
6MM Mashburn Mag	Custom	#1	6MM
6MM Remington	A	#1	6MM
6MM Remington Improved 40°	D	#1	6MM
6MM Remington Improved 30°	Custom	#1	6MM
6MM TCU	C	#10	6MM
6MM SM Wasp	Custom	#2	6MM
6MM Wasp	Custom	#2	6MM
6MM Olewine	Custom	#1	6MM
6MM B.R. Remington	B	#1	6MM

Cartridge	Series	Shellholder	Trimmer Pilot
6MM Dasher	Custom	#1	6MM
6MM P.P.C. USA	B	#12	6MM
6MM International (Walker)	Custom	#1	6MM
6MM American (Stekl)	Custom	#2	6MM
6MM Cheetah Mark I (40°)	Custom	#1	6MM
6MM/224 Weatherby	Custom	#4	6MM
6MM/222 Remington	Custom	#10	6MM
6MM/223 Remington (6MM x 45MM)	C	#10	6MM
6MM/225 Winchester	Custom	#4	6MM
6MM/22-250 Remington	D	#1	6MM
6MM/22-250 Improved 28° or 40°	Custom	#1	6MM
6MM/284 Winchester	C	#1	6MM
6MM/30-30 Winchester	Custom	#2	6MM
6MM/30-30 Win Improved 40°	Custom	#2	6MM
6MM/300 WSM	Custom	#6	6MM
6MM x 44 BR	Custom	#1	6MM
<b>NEW</b> 6MM x 47 Lapua	N.A.	#1	6MM
6MM x 47 (6MM-222 Rem Mag)	Custom	#10	6MM
6MM x 62 Freres	Custom	#7	6MM
6MM/06	Custom	#1	6MM
6MM/06 Improved 40°	Custom	#1	6MM
<hr/>			
25 Remington	D	#5	25 Cal.
25 IHMSA*	Custom	#1	25 Cal.
25 Bullberry	Custom	#2	25 Cal.
25 TCU	Custom	#10	25 Cal.
25 B.R. Remington	Custom	#1	25 Cal.
25 Souper (25/308 Win)	Custom	#1	25 Cal.
25 WSSM	A	#6	25 Cal.
25 Gibbs	Custom	#1	25 Cal.
25-06 Remington	D	#1	25 Cal.
25-06 Remington Improved 40°	A	#1	25 Cal.
25-20 Winchester	B	#3	25 Cal.
25-20 Single Shot	Custom	#10	25 Cal.
25-35 Winchester	D	#2	25 Cal.
25-35 Ackley Improved 40°	Custom	#2	25 Cal.
25-36 Marlin	Custom	#2	25 Cal.
25/221 Remington	Custom	#10	25 Cal.
25/222 Remington	Custom	#10	25 Cal.
25/222 Remington Mag	Custom	#10	25 Cal.
25/223 Remington	Custom	#10	25 Cal.
25/225 Winchester	Custom	#4	25 Cal.
25/243 Improved 40°	Custom	#1	25 Cal.
25/284 Winchester	D	#1	25 Cal.
25/300 WSM	Custom	#6	25 Cal.
25/300 Rem SA UM*	Custom	#6	25 Cal.
25/300 Rem Ultra Mag	Custom	#6	25 Cal.
25/308 Winchester	Custom	#1	25 Cal.
250 Savage (250-3000)	B	#1	25 Cal.
250 Savage Improved 40°	D	#1	25 Cal.
250 Savage Improved 28°	Custom	#1	25 Cal.
256 Winchester Mag	B	#12	25 Cal.
257 Roberts	A	#1	25 Cal.
257 Roberts Improved 40°	C	#1	25 Cal.
257 Weatherby Mag	B	#6	25 Cal.
257 STW	Custom	#6	25 Cal.
257 Kimber	Custom	#10	25 Cal.
257 Durham Jet	Custom	#1	25 Cal.
<hr/>			
256 (6.5MM) Newton	Custom	#1	6.5MM
260 Bobcat	Custom	#1	6.5MM
260 Remington	A	#1	6.5MM
260 Remington Improved 40°	Custom	#1	6.5MM
264 Jarrett	Custom	#1	6.5MM
264 Winchester Mag	B	#6	6.5MM
<b>NEW</b> 6.5 Grendel™	D	#12	6.5MM
6.5 Bullberry	Custom	#2	6.5MM
6.5MM Gibbs	Custom	#1	6.5MM
6.5MM IHMSA	Custom	#1	6.5MM
6.5MM Panther	Custom	#1	6.5MM
6.5MM B.R. Remington	Custom	#1	6.5MM
<b>NEW</b> 6.5MM x 47	N.A.	#1	6.5MM
6.5MM Remington Mag	D	#6	6.5MM
6.5MM TCU	Custom	#10	6.5MM
6.5MM/22-250 Improved 40°	Custom	#1	6.5MM
6.5-06 (A-Square)	C	#1	6.5MM
6.5MM/06 Improved 35° or 40°	Custom	#1	6.5MM
6.5MM x 39 (M.O.A.)	Custom	#12	6.5MM
6.5MM x 50 Japanese	D	#4	6.5MM
6.5MM x 52 Carcano	Custom	#1	6.5MM
6.5MM x 54 Mannlicher	D	#24	6.5MM
6.5 X 55 Swedish	A	#7	6.5MM
6.5 X 55 Swedish Improved 40°	Custom	#7	6.5MM
6.5MM X 55 SKAN	Custom	#1	6.5MM
6.5MM x 57 Mauser	D	#1	6.5MM
6.5MM x 64 Brenneke	Custom	#1	6.5MM
6.5MM x 65 RWS	Custom	#1	6.5MM
6.5MM x 68	Custom	#19	6.5MM
6.5MM/223 Remington	Custom	#10	6.5MM
6.5MM/243 WSSM	Custom	#6	6.5MM
6.5MM/250 Savage	Custom	#1	6.5MM
6.5MM STW	Custom	#6	6.5MM
6.5MM Redding (6.5/243 Imp. 30°)	Custom	#1	6.5MM

# Die Caliber Reference Chart

Cartridge	Series	Shellholder	Trimmer Pilot
6.5MM/257 Roberts	Custom	# 1	6.5MM
6.5MM/257 Roberts Imp. 40°	Custom	# 1	6.5MM
6.5MM/284 Winchester	B	# 1	6.5MM
6.5MM/300 WSM	Custom	# 6	6.5MM
6.5MM/300 Rem SA UM*	Custom	# 6	6.5MM
6.5MM/300 Weatherby Mag	Custom	# 6	6.5MM
6.5MM/300 Rem Ultra Mag	Custom	# 6	6.5MM
6.5MM/308 Win	Custom	# 1	6.5MM
6.5MM/308 Improved 30° or 40°	Custom	# 1	6.5MM
6.8MM Remington SPC	B	# 5	270 Cal.
270 Redding (270/243 Imp. 30°)	Custom	# 1	270 Cal.
270 Winchester	A	# 1	270 Cal.
270 Winchester Improved 40°	Custom	# 1	270 Cal.
270 Weatherby Mag	B	# 6	270 Cal.
270 Gibbs	Custom	# 1	270 Cal.
270 Jarrett	Custom	# 1	270 Cal.
270 IHMSA	Custom	# 1	270 Cal.
270/257 Roberts Improved 40°	Custom	# 1	270 Cal.
270/284 Winchester	Custom	# 1	270 Cal.
270 WSM	A	# 6	270 Cal.
270/300 Winchester Mag	Custom	# 6	270 Cal.
270/300 Weatherby	Custom	# 6	270 Cal.
270/300 Rem Ultra Mag	Custom	# 6	270 Cal.
270/308 Winchester	Custom	# 1	270 Cal.
270/308 Improved 40°	Custom	# 1	270 Cal.
270/338 Winchester	Custom	# 6	270 Cal.
280 Remington	A	# 1	7MM
280 Remington Improved 40°	C	# 1	7MM
280/30 British	Custom	# 1	7MM
284 Winchester	B	# 1	7MM
284 Baer	Custom	# 6	7MM
7MM Remington Mag	A	# 6	7MM
7MM GNR	Custom	# 4	7MM
7MM US	Custom	# 2	7MM
7MM X 33 SAKO	Custom	#13	7MM
7MM B.R. Remington	B	# 1	7MM
7MM TCU	B	#10	7MM
7MM ULA	Custom	# 6	7MM
7MM INT-R	Custom	# 2	7MM
7MM INT-X	Custom	# 1	7MM
7MM Super Mag	Custom	#12	7MM
7MM E.T. Gates	Custom	# 2	7MM
7MM Dakota *	Custom	#404*	7MM
7MM IHMSA	Custom	# 1	7MM
7MM Rem SA UM	B	# 6	7MM
7MM WSM	B	# 6	7MM
7MM Weatherby Mag	B	# 6	7MM
7MM Hart Mag	Custom	# 6	7MM
7MM Gibbs	Custom	# 1	7MM
7MM Remington Ultra Mag	B	# 6	7MM
7MM STE (Shooting Times)	Custom	# 2	7MM
7MM STW (Shooting Times)	B	# 6	7MM
7MM-08 Remington	A	# 1	7MM
7MM-08 Improved 30°	Custom	# 1	7MM
7MM-08 Remington Imp. 40°	D	# 1	7MM
7-30 Waters	C	# 2	7MM
7-30 Improved 40°	Custom	# 2	7MM
7MM x 44 B.R.	Custom	# 1	7MM
7MM x 47 (7MM-222 Rem Mag)	Custom	#10	7MM
7MM x 57 Mauser	A	# 1	7MM
7MM x 57 Improved 40°	D	# 1	7MM
7MM x 61 Sharpe & Hart	Custom	# 6	7MM
7MM x 64 Brenneke	C	# 1	7MM
7MM x 66 Vom Hofe S.E.	Custom	# 6	7MM
7MM/223 Remington	Custom	#10	7MM
7MM/250 Savage	Custom	# 1	7MM
7MM/300 Weatherby Mag	D	# 6	7MM
7MM/300 Winchester	Custom	# 6	7MM
7MM/300 Remington Ultra Mag	Custom	# 6	7MM
7MM/350 Remington Mag	Custom	# 6	7MM
7.35MM Carcano	Custom	#24	7.35MM
7.5 French MAS	Custom	# 7	30 Cal.
7.5 x 55 Swiss (K-31)	C	# 2	30 Cal.
7.62MM x 39	B	#12	30 Cal.
7.62MM Russian (7.62MM x 54R)	B	#15	30 Cal.
30 B.R. Remington	Custom	# 1	30 Cal.
30 IHMSA	Custom	# 1	30 Cal.
30 GNR	Custom	# 2	30 Cal.
30 Herrett	Custom	# 2	30 Cal.
30 Remington	D	# 5	30 Cal.
30 Gibbs	Custom	# 1	30 Cal.
30 Hart Mag	Custom	# 6	30 Cal.
30 x 44 B.R.	Custom	# 1	30 Cal.
30-06 Springfield	A	# 1	30 Cal.
30-06 Improved 40°	C	# 1	30 Cal.
30-20 TC	C	# 3	30 Cal.

Cartridge	Series	Shellholder	Trimmer Pilot
30-30 Winchester (30 WCF)	A	# 2	30 Cal.
30-30 Improved 40°	D	# 2	30 Cal.
30-40 Krag	C	# 8	30 Cal.
30/223 Remington	Custom	#10	30 Cal.
30/284 Winchester	Custom	# 1	30 Cal.
30/338 Winchester Mag	C	# 6	30 Cal.
30/8MM Rem Mag (30 Super)	Custom	# 6	30 Cal.
30/350 Remington Mag	Custom	# 6	30 Cal.
30-378 Weatherby Mag	C	#18	30 Cal.
300/221 Remington	D	#10	30 Cal.
300 H & H Magnum	B	# 6	30 Cal.
300 H & H Improved 40°	Custom	# 6	30 Cal.
300 Savage	B	# 1	30 Cal.
300 Dakota *	Custom	#404*	30 Cal.
300 Winchester Mag	A	# 6	30 Cal.
300 Winchester Imp. 40°	Custom	# 6	30 Cal.
300 Weatherby Mag	A	# 6	30 Cal.
300 Mashburn Mag	Custom	# 6	30 Cal.
300 Kong *	Custom	#18	30 Cal.
300 Herrett	Custom	# 1	30 Cal.
300 Jarrett	Custom	# 6	30 Cal.
300 Pegasus *	Custom	#35	30 Cal.
300 Baer *	Custom	#35	30 Cal.
300 Rem SA UM	B	# 6	30 Cal.
300 Lapua Mag	Custom	#35	30 Cal.
300 Remington Ultra Mag	A	# 6	30 Cal.
300 WSM	A	# 6	30 Cal.
<b>NEW</b> 30 TC	B	#1	30 Cal.
303 Savage	C	#21	30 Cal.
<b>NEW</b> 308 Marlin Express	B	#2	30 Cal.
308 Winchester/307 Winchester	A	#1 & #2	30 Cal.
308 Winchester Imp. 40°	Custom	# 1	30 Cal.
308 Baer	Custom	# 6	30 Cal.
308 Bluebird	Custom	# 1	30 Cal.
308 Norma Mag	B	# 6	30 Cal.
308 x 1.5 Barnes	Custom	# 1	30 Cal.
308 x 1.75	Custom	# 1	30 Cal.
30/338 Lapua Mag *	Custom	#35	30 Cal.
30/416 Rigby Improved 40° *	Custom	#35	30 Cal.
7.65MM x 53 Mauser (Belgian)	D	# 1	31 Cal.
7.7MM x 58 Japanese	D	# 1	31 Cal.
303 British	B	# 8	31 Cal.
32 Winchester Spec.	C	# 2	8MM
32 Remington	C	# 5	8MM
32-40 Winchester	B	# 2	8MM
325 WSM	B	# 6	8MM
7.92MM x 33 Kurz Mauser	Custom	# 1	8MM
8MM Gibbs	Custom	# 1	8MM
8MM Remington Mag	Custom	# 6	8MM
8MM Lebel	Custom	#26	8MM
8MM/06	Custom	# 1	8MM
8MM/06 Improved 40°	Custom	# 1	8MM
8MM/338 Winchester	Custom	# 6	8MM
8MM/300 Winchester Mag	Custom	# 6	8MM
8MM/300 WSM	Custom	# 6	8MM
8MM x 52 R Siamese	Custom	#18	8MM
8MM x 56 Mannlicher	Custom	# 6	8MM
8MM x 57 Mauser	A	# 1	8MM
8MM x 57 Improved 40°	Custom	# 1	8MM
8MM x 60S	Custom	# 1	8MM
8MM x 64S Brenneke	Custom	# 4	8MM
8MM x 68S	Custom	#19	8MM
8.15 x 46R	Custom	# 2	8MM
33 Winchester	D	#18	338 Cal.
330 Baer *	Custom	#35	338 Cal.
330 Dakota *	Custom	#404*	338 Cal.
338 Winchester Mag	A	# 6	338 Cal.
338 IHMSA	Custom	# 1	338 Cal.
338 Gibbs	Custom	# 1	338 Cal.
338 GNR	Custom	# 8	338 Cal.
338 Baer	Custom	# 6	338 Cal.
338 Jarrett	Custom	# 6	338 Cal.
338-06 (A-Square)	C	# 1	338 Cal.
338/06 Improved 40°	D	# 1	338 Cal.
338-270 HGT	Custom	# 1	338 Cal.
338/284 Winchester	Custom	# 1	338 Cal.
338/308 Winchester	Custom	# 1	338 Cal.
338 Federal	B	# 1	338 Cal.
338/308 Norma Mag	Custom	# 6	338 Cal.
338/300 WSM	Custom	# 6	338 Cal.
338/8MM Remington Mag	Custom	# 6	338 Cal.
338/300 Winchester Mag	Custom	# 6	338 Cal.
338/350 Remington Mag	Custom	# 6	338 Cal.
338/378 Weatherby Mag	D	#18	338 Cal.
340 Weatherby Mag	B	# 6	338 Cal.
338 Lapua Mag	C	#35	338 Cal.
338 Remington Ultra Mag	B	# 6	338 Cal.

# Die Caliber Reference Chart

Cartridge	Series	Shellholder	Trimmer Pilot
348 Winchester	C	#20	348 Cal.
35 Remington	B	# 1	35 Cal.
35 Winchester	C	# 8	35 Cal.
35 Whelen	B	# 1	35 Cal.
35 Whelen Improved 40°	D	# 1	35 Cal.
35 IHMSA	Custom	# 1	35 Cal.
35 Brown Whelen	Custom	# 1	35 Cal.
35/284 Winchester	Custom	# 1	35 Cal.
35/30-30 Winchester	Custom	# 2	35 Cal.
35/8MM Remington Mag	Custom	# 6	35 Cal.
35/338 Winchester Mag	Custom	# 6	35 Cal.
35/300 Weatherby	Custom	# 6	35 Cal.
35/300 WSM	Custom	# 6	35 Cal.
350 GNR	Custom	# 8	35 Cal.
350 Remington Mag	B	# 6	35 Cal.
357 Herrett	Custom	# 2	35 Cal.
358 Dakota *	Custom	#404*	35 Cal.
358 Winchester/356 Winchester	B	#1 & #2	35 Cal.
358 Winchester Imp. 40°	Custom	# 1	35 Cal.
358 Norma Mag	C	# 6	35 Cal.
358 STA (Shooting Times)	Custom	# 6	35 Cal.
9MM x 56 Mannlicher	Custom	# 1	35 Cal.
9MM x 57 Mauser	C	# 1	35 Cal.

9.3MM x 57 Mauser	Custom	# 1	9.3MM
9.3MM x 62 Mauser	D	# 1	9.3MM
9.3MM x 64 Brenneke	Custom	#33*	9.3MM
<b>NEW</b> 9.3MM x 74R	D	# 6	9.3MM
9.3MM Wilson	Custom	# 6	9.3MM
360 Nitro Express #2 *	Custom	# 26	9.3MM

9.5MM Mannlicher	Custom	# 1	375 Cal.
375 Dakota *	Custom	#404*	375 Cal.
375 Whelen	Custom	# 1	375 Cal.
375 Whelen Improved 40°	Custom	# 1	375 Cal.
375 H & H Magnum	A	# 6	375 Cal.
375 H & H Magnum Imp. 40°	D	# 6	375 Cal.
375 Mashburn Mag	Custom	# 6	375 Cal.
375 Weatherby Mag	D	# 6	375 Cal.
375/284 Winchester	Custom	# 1	375 Cal.
375/300 Winchester Mag	Custom	# 6	375 Cal.
375/300 WSM	Custom	# 6	375 Cal.
<b>NEW</b> 375 Ruger	B	# 6	375 Cal.
375 Remington Ultra Mag	C	# 6	375 Cal.
375/8MM Remington Mag	Custom	# 6	375 Cal.
375/338 Winchester	Custom	# 6	375 Cal.
375/350 Remington Mag	Custom	# 6	375 Cal.
375/444 Marlin	D	# 19	375 Cal.
378 GNR	Custom	# 8	375 Cal.
378 Weatherby Mag	D	#18	375 Cal.

416 Remington Mag	C	# 6	416 Cal.
416 Weatherby Mag	D	#18	416 Cal.
416/300 Rem Ultra Mag*	Custom	# 6	416 Cal.
416/300 WSM	Custom	# 6	416 Cal.
416 Hoffman	Custom	# 6	416 Cal.
416 Taylor	Custom	# 6	416 Cal.
416 Jarrett	Custom	#18	416 Cal.
416 Rigby *	Custom	#35	416 Cal.
416 GNR	Custom	#20	416 Cal.
416 Dakota *	Custom	#404*	416 Cal.
416 Express	Custom	# 6	416 Cal.
404 Jeffery *	Custom	#404*	N.A.
425 Express *	Custom	# 6	N.A.

450 Ackley Magnum	Custom	# 6	458 Cal.
450 GNR	Custom	#20	458 Cal.
450 Dakota *	Custom	#18	458 Cal.
460 Weatherby Mag	D	#18	458 Cal.

<b>NEW</b> 470 Nitro Express	D	#31	470 Cal.
------------------------------	---	-----	----------

## THREE DIE SETS

25 ACP (25 Auto)	Custom	#27	N.A.
25 Hornet	Custom	#14	25 Cal.
30 M1 Carbine	A	#22	30 Cal.
7.65MM French MAS Auto	Custom	#14	30 Cal.
30 Luger	D	#13	30 Cal.
30 Mauser (7.62 X 25)	C	#13	30 Cal.
32 Short Colt	Custom	#10	N.A.
32 Long Colt	Custom	#10	N.A.
32 ACP	B	#22	31 Cal.
32 Smith & Wesson (Short)	Custom	#10	31 Cal.
32 Smith & Wesson Long	A	#10	31 Cal.
32 H & R Magnum	A	#10	31 Cal.
32 S & W Long/32 H & R Mag	A	#10	31 Cal.
32-20 Winchester	B	# 3	31 Cal.

Cartridge	Series	Shellholder	Trimmer Pilot
8MM Lebel Revolver	Custom	# 3	N.A.
8MM Nambu	Custom	# 5	N.A.
38 Super Auto	B	# 5	9MM
380 Auto	B	#10	9MM
9MM Steyr	Custom	#13	9MM
9MM Luger	A	#13	9MM
9MM x 18 Ultra	Custom	#10	9MM
9MM Makarov	D	#13	9.3MM
351 Winchester S.L.	D	# 5	N.A.
357 Bobcat	Custom	#19	35 Cal.
357 SIG	C	# 5	35 Cal.
357 Auto Mag	Custom	# 1	35 Cal.
357/44 Bain & Davis	Custom	#19	35 Cal.
38 Smith & Wesson	D	#12	35 Cal.
38/45 ACP	Custom	# 1	35 Cal.
38 Special	A	#12	35 Cal.
357 Magnum	A	#12	35 Cal.
38 Spec./357 Magnum	A	#12	35 Cal.
357 Maximum	Custom	#12	35 Cal.

375 Winchester	B	# 2	375 Cal.
375 Super Mag	Custom	# 2	375 Cal.
38-55 Winchester & Ballard	C	# 2	375 Cal.
38-56 Winchester	D	#18	375 Cal.
38-72 Winchester	Custom	# 8	375 Cal.

41 Long Colt	C	# 1	N.A.
40 Smith & Wesson	A	# 5	10MM
10MM Auto	A	# 5	10MM
400 COR-BON	Custom	# 1	10MM
40 Super	D	# 1	10MM
40 S & W/10MM Auto	A	# 5	10MM
10MM Centaur	Custom	# 1	10MM
38-40 Winchester	C	# 9	10MM

40-70 Sharps (Straight) *	Custom	# 8	40 Cal.
40-65 Winchester	C	#18	40 Cal.
40-82 Winchester	D	#18	40 Cal.
401 Winchester S.L.	D	# 1	40 Cal.
40-50 Sharps Straight *	Custom	# 8	40 Cal.
40-50 Sharps Bottleneck *	Custom	#18	40 Cal.
40-70 Gov't (Sharps BN2.1") *	Custom	#18	40 Cal.
40-70 Sharps Bottleneck *	Custom	#18	40 Cal.
40-90 Sharps Bottleneck *	Custom	#18	40 Cal.

405 Winchester	D	# 8	41 Cal.
41 Magnum	B	#21	41 Cal.
41 GNR	Custom	#19	41 Cal.
41 Action Express	Custom	#13	41 Cal.
414 Super Mag	Custom	#21	41 Cal.

44 Russian	C	#19	44 Cal.
44 Special	A	#19	44 Cal.
44 Magnum	A	#19	44 Cal.
44 Spec./44 Mag	A	#19	44 Cal.
445 Super Mag	Custom	#19	44 Cal.
44-40 Winchester	A	# 9	44 Cal.
444 Marlin	C	#19	44 Cal.

11MM Mauser (11.15 x 60R)	Custom	#16	N.A.
---------------------------	--------	-----	------

45 GAP	—	# 1	45 Cal.
45 ACP & AR	A	#1 & #17	45 Cal.
45 Winchester Mag	D	# 7	45 Cal.
45 S&W Schofield	Custom	#23	45 Cal.
45 Colt/454 Casull	A	#23	45 Cal.
450 Marlin	C	# 6	45 Cal.
455 Webley	D	# 6	45 Cal.
460 S&W Magnum	B	#23	45 Cal.

<b>NEW</b> 45-60 Winchester	D	#18 or #26	458 Cal.
45-70 U.S. Govt.	B	#18	458 Cal.
45-90 Winchester (Sharps)	D	#18	458 Cal.
458 x 2" American	Custom	# 6	458 Cal.
458 Winchester Mag	B	# 6	458 Cal.
458 Lott	D	# 6	458 Cal.
45-100 Sharps (Straight) *	Custom	#18	458 Cal.
45-110 Sharps (Straight) *	Custom	#18	458 Cal.
45-120 Sharps (Straight) *	Custom	#18	458 Cal.

470 Capstick *	Custom	# 6	N.A.
480 Ruger/475 Linebaugh	C	#18	N.A.
500 S&W Magnum	B	#15	N.A.

\* & \*\*Special Price Group

# Popular Case Forming Dies

Case forming dies are made on a custom basis for those who wish to form brass cases from one caliber to another. Most case forming is done to produce ammunition that is not factory available. All wildcat cartridges and many obsolete calibers fall into this category. Case forming dies are designed to change the shape of the original parent case in small increments to avoid overworking the brass and to prolong case life. After using the proper form dies and/or Form & Trim Die, full length resizing is required.

Below are a few examples of commonly formed cartridges listed with their parent case and the forming dies that are required. We make many others and they all come with complete, easy to follow instructions. If you need to form a caliber that is not listed, simply write us or call explaining what you would like to do.

**NOTE: Full length resizing is a necessary final operation after all case forming to insure proper chambering.**

Part No.		Price
<b>17 Remington From 222 Rem Mag</b>		
90217	17 Remington Form #1	\$ 66.00
83217	17 Remington Form & Trim Die	46.50
<b>17 Ackley Hornet From 22 Hornet</b>		
90500	17 Ackley Hornet Form #1	66.00
83500	17 Ackley Form & Trim Die	82.50
11514	Extended Shellholder #14E	16.80
<b>17 Ackley Bee From 218 Bee</b>		
90508	17 Ackley Bee Form #1	66.00
83508	17 Ackley Bee Form & Trim Die	82.50
11503	Extended Shellholder #3E	16.80
<b>17 Mach IV From 221 Remington</b>		
90504	17 Mach IV Form #1	66.00
83504	17 Mach IV Form & Trim Die	63.00
11510	Extended Shellholder #10E	16.80
<b>221 Remington From 222 or 223 Remington</b>		
90101	221 Remington Form #1	66.00
83101	221 Remington Form & Trim Die	33.60
11510	Extended Shellholder #10E	16.80
<b>22 Remington Jet From 357 Magnum</b>		
90304	22 Remington Jet Form #1	66.00
94304	22 Remington Jet Form #2	66.00
83304	22 Remington Jet Form & Trim Die	63.00
11512	Extended Shellholder #12E	16.80
<b>5.7MM Johnson From 30 M1 Carbine</b>		
90401	5.7MM Johnson Form #1	66.00
83401	5.7MM Johnson Form & Trim Die	82.50
11522	Extended Shellholder #22E	16.80
<b>219 Zipper From 30-30 Winchester</b>		
90360	219 Zipper Form #1	66.00
94360	219 Zipper Form #2	66.00
83360	219 Zipper Form & Trim Die	57.00
<b>219 Donaldson Wasp From 30-30 Winchester</b>		
90403	219 Donaldson Wasp Form #1	66.00
94403	219 Donaldson Wasp Form #2	66.00
83403	219 Donaldson Wasp Form & Trim Die	63.00
<b>22 Savage H.P. From 30-30 Winchester</b>		
90338	22 Savage H.P. Form #1	66.00
83338	22 Savage H.P. Form & Trim Die	57.00
<b>6MM PPC From 7.62MM x 39</b>		
90319	6MM PPC Form #1 Die	66.00
83319	6MM PPC Form & Trim Die	46.50
11512	Extended Shellholder #12E	16.80
<b>6MM B.R. Remington From 7MM B.R. Remington</b>		
90565	6.5MM B.R. Remington Form #1	66.00
83317	6MM B.R. Remington Form & Trim Die	46.50
11501	Extended Shellholder #1E	16.80
<b>6MM/284 Winchester From 284 Winchester</b>		
90414	6MM/284 Winchester Form #1	66.00
83414	6MM/284 Winchester Form & Trim Die	57.00
<b>256 Winchester Magnum From 357 Magnum</b>		
90233	256 Winchester Magnum Form #1	66.00
94233	256 Winchester Magnum Form #2	66.00
83233	256 Winchester Magnum Form & Trim Die	46.50
11512	Extended Shellholder #12E	16.80
<b>25 Remington From 30 Remington</b>		
90325	25 Remington Form #1	66.00
83325	25 Remington Form & Trim Die	63.00

Part No.		Price
<b>257 Roberts Imp 40° From 257 Roberts</b>		
No Forming Dies Required – Fireform In The Improved Chamber		
<b>25-35 Winchester From 30-30 Winchester</b>		
90221	25-35 Winchester Form #1	\$ 66.00
83221	25-35 Winchester Form & Trim Die	63.00
<b>6.5MM Rem Mag From 7MM Rem Mag or 338 Win Mag</b>		
83266	350 Rem Mag Form & Trim Die	46.50
90231	6.5MM Rem Mag Form #1	66.00
83231	6.5MM Rem Mag Form & Trim Die	63.00
<b>7MM IHMSA From 300 Savage</b>		
90240	7MM IHMSA Form #1	66.00
<b>7MM TCU From 223 Remington</b>		
No Forming Dies Required - Use		
91242	F.L. Sizing Die W/Tapered Expander	63.00
<b>7MM STW From 8MM Remington Magnum</b>		
83544	7MM STW Form & Trim Die	33.60
<b>7.65MM x 53 Mauser From 30-06 Springfield</b>		
83243	7.65MM x 53 Mauser Form & Trim Die	57.00
<b>7.7MM x 58 Japanese From 30-06 Springfield</b>		
83244	7.7MM x 58 Japanese Form & Trim Die	57.00
<b>30 Herrett From 30-30 Winchester</b>		
83274	30 Herrett Form & Trim Die	82.50
<b>30/378 Weatherby Mag From 378 Weatherby Mag</b>		
90547	30/378 Weatherby Mag Form #1	66.00
83547	30/378 Weatherby Mag Form & Trim Die	57.00
<b>300/221 Remington From 223 Remington</b>		
83432	300/221 Remington Form & Trim Die	63.00
11510	Extended Shellholder #10E	16.80
<b>32 Remington From 30 Remington</b>		
No Forming Dies Required - Use		
91332	F.L. Sizing Die W/Tapered Expander	64.50
<b>33 Winchester From 45-70 Govt.</b>		
90205	33 Winchester Form #1	66.00
83205	33 Winchester Form & Trim Die	63.00
<b>357 Herrett From 30-30 Winchester</b>		
83267	357 Herrett Form & Trim Die	82.50
<b>350 Remington Mag From 338 Winchester Mag</b>		
83266	350 Remington Mag Form & Trim Die	46.50
<b>356 Winchester From 444 Marlin</b>		
83227	358 Win/356 Win Form & Trim Die	46.50
<b>358 Winchester From 308 Winchester</b>		
No Forming Dies Required - Use		
91227	F.L. Sizing Die w/Tapered Expander	51.00
<b>35 Whelen From 30-06 Springfield</b>		
No Forming Dies Required - Use		
91215	F.L. Sizing Die W/Tapered Expander	51.00
<b>38-56 Winchester From 45-70 Govt.</b>		
90463	38-56 Winchester Form # 1	66.00
83463	38-56 Winchester Form & Trim Die	63.00
<b>40-65 Winchester From 45-70 Govt.</b>		
83465	40-65 Winchester Form & Trim Die	57.00
<b>40-70 Govt. From 45-70 Govt.</b>		
83805	40-70 Govt. Form & Trim Die	82.50



**Our most versatile powder measure... Competition proven with a broad range of charging capacity.**

*The Competition style operating handle is supplied with all Model 3BR powder measures*



**ITEM NO. 03331 Handgun Metering Chamber**  
(Fits only 3BR Measures) Charging range approx. 0 to 10 grains . . . . \$ 60.00



**ITEM NO. 03330 Universal Metering Chamber**  
(Fits only 3BR Measures) Charging range approx. 5 to 100 grains . . . . \$ 60.00

**ITEM NO. 03018 Powder Measure Mounting Bracket**  
(shelf bracket fits all Redding powder measures).  
. . . . \$ 15.00



**There are no aluminum parts to wear out in a Redding Powder Measure!**

## **Match-Grade Model 3BR Powder Measure**

*The Match-Grade Model 3BR was created to be the ultimate powder measure... "out of the box" match ready! Since its creation this powder measure has been helping Silhouette shooters and Benchrest shooters win matches and set new records.*

It all started with the time proven accuracy and reliability of the original Model 3 Powder Measure. The Model 3BR Powder Measure utilizes all of the features of the original Model 3 and to that we added the conversion features that Benchrest shooters were looking for.

It quickly became our most popular powder measure for two very good reasons . . . Its broad range of charging capacity and its performance record.

**ITEM NO. 03500 Match-Grade Powder Measure 3BR**  
with Universal Chamber, Charging range approx. 5 to 100 grains . . . . . \$199.50

**ITEM NO. 03700 Match-Grade Powder Measure 3BRK**  
Includes both metering chambers . . . . . \$247.50

### **Competition Proven Conversion Features...**

Now used on the Match-Grade Model 3BR and both Competition Powder Measures, the Model BR-30 and 10X Pistol/Small Rifle.



#### **ADJUSTABLE POWDER BAFFLE**

*To create exceptional uniformity from charge to charge we have placed an adjustable powder baffle above the metering chamber. This maintains a constant amount of powder above the metering chamber regardless of the level of powder in the reservoir.*



#### **POSITIVE LOCK**

*When the micrometer adjustment lock screw (opposite side) is loosened to change settings, the micrometer body cannot move, since the micrometer is held in place by a separate lock screw. In a measure this precise, there is no room for error and nothing can be left to chance.*



#### **ZERO BACKLASH MICROMETER**

*A special mechanism is used inside all Match-Grade and Competition Micrometers to eliminate backlash and take up all the minute tolerances in the screw threads. The parts can't work loose and are fully self-adjusting. It will even compensate for wear in the years to come. Your setting is guaranteed to be precise and exactly repeatable.*

*Designed specifically for Benchrest Competition.*

## **Competition Model BR-30 Powder Measure**

The Competition Model BR-30 Powder Measure is truly a competition model with some very special features. One of these features (the drum and micrometer) limits the overall charging range from a low of 10 grains (dependent upon powder density) to a maximum of approximately 50 grains.

As a result we do not expect this model to be the proper choice for everyone. If, however, you are a serious competitive shooter and your loading requirements are generally between 10 and 50 grains, this is certainly the measure to choose.

This measure uses all of the competition proven features of the Match-Grade Model 3BR. To achieve the most uniform powder metering possible for Benchrest Competition, at a targeted charge weight of approximately 30 grains, (hence the name BR-30) an entirely new drum and metering unit was created. The diameter of the metering cavity was reduced and the metering plunger was given a unique hemispherical or "cup" shape. This shape creates a powder cavity that resembles the bottom of a test tube to alleviate irregular powder settling and to enhance charge to charge uniformity.

A special operating handle was also created for this model. It's a rotating handle, slightly heavier to help you maintain a more uniform stroke.

**ITEM NO. 03300 Competition Model BR-30 Powder Measure . . . . . \$234.00**

*"I have been using a Redding BR-30 powder measure for the last 9-1/2 years. I have found it as repeatable as anything on the market and it is more consistent than other style measures. I feel this is because the Redding measure "sees" the same cut every time because the opening is always the same regardless of the micrometer setting."*

*- Bob Blaine, Sinclair International, New Haven, Indiana*

*Designed specifically for handgun and small capacity rifle cartridges.*

## **Competition Model 10X Pistol & Small Rifle Powder Measure**

This powder measure uses all of the special features of the Competition Model BR-30 combined with an entirely new drum and metering unit designed to provide the most uniform metering of small charge weights.

To achieve the best metering possible at the targeted charge weight of approximately 10 grains, the diameter of the metering cavity was reduced and the metering plunger was given the unique hemispherical, cup shape of our successful Model BR-30. The result is a very specialized small capacity powder measure with a charge weight range of approximately 1 to 25 grains.

To provide increased versatility, the 10X-Pistol Powder Measure has a drum assembly that can be easily changed from right to left-handed operation. By simply removing the micrometer unit, the drum orientation can be changed so that the operating handle is on the left side of the powder measure. In addition to offering left-handed reloaders increased ease of operation, this feature may allow the 10X-Pistol Powder Measure to be adapted to some progressive reloading presses.

**ITEM NO. 03400 Competition Model 10X Powder Measure . . . . . \$234.00**



*Shown with  
Optional  
Bench Stand  
and Clamp  
...see page 37*

**IMPORTANT  
Redding Powder  
Measures Are  
Not Intended  
For Use With  
Black Powder!**

**Features:**

- Cast mounting bracket included with all Redding Powder Measures.
- Large capacity clear powder reservoir.
- Clear "See thru" drop tube accepts all calibers from .22 thru .50 cal.
- Body has standard 7/8"-14 thread to fit mounting bracket and optional bench stand with locking ring for fast dumping.



*Time proven accuracy and reliability*

# Model 3 Powder Measure

The *original* Redding Model 3, time proven for accuracy and reliability. It has a micrometer metering chamber right in front for easy setting and reading. The micrometer makes it is possible to record your favorite settings and return to the same place weeks later when you wish to create the same load.

Precision machined cast iron frame to give you years and years of service.

The hand honed fit between the frame and hard surfaced drum enables all Redding Powder Measures to easily cut and meter even the most difficult powders.

**ITEM NO. 03000 Powder Measure**  
with Universal Metering Chamber,  
Charging range approx. 5 to 100 grains . . . . \$159.00

**ITEM NO. 03200 Powder Measure Model 3K,**  
Includes both Metering Chambers . . . . . \$192.00

**ITEM NO. 03313**  
**Handgun Metering Chamber**  
(Fits only Model 3 Measures)  
Charging range approx. 0 to 10 grains . . . . . \$43.50



**IMPORTANT**  
*Redding Powder Measures Are Not Intended For Use With Black Powder!*

# Model No. 2 Powder & Bullet Scale



Designed and manufactured with the utmost attention to accuracy and sensitivity standards. The Model 2 scale includes a magnetic dampened beam swing for extra fast readings plus, hardened and ground knife edges ride in precision milled stainless steel bearing seats that will not crack, chip or lose their alignment.

The graduated plate at the beam pointer is marked in 1/10 grain increments for easy reading of over or under charges. This eliminates the need to move the counterpoises to check powder charge variations.

*All Redding scales have a lifetime guarantee.*

**ITEM NO. 02000**  
**Master Powder and Bullet Scale . . . . \$102.00**

**Features:**

- 505 grain capacity
- 1/10 grain accuracy.
- pour spout pan.
- simple two counterpoise system.
- 1/10 grain over/under graduations.

**We invite you to test the Redding Model 2 Scale!**

*Put it side by side with any competition regardless of price. Using tweezers, drop one or two granules of powder into the pan and watch the scale beam pointer react, then do the same with our competition. Next, zero the scale properly and move the small 1/10 grain counterpoise 3/10 grain. Watch the scale beam pointer move to an indication of -3/10 grain. Try this with our competition. Every Redding scale manufactured is individually tested and adjusted to U.S. Bureau of Standards Approved Master Weights, and guaranteed accurate to less than 1/10 grain!*

# Model No. 5 Powder Trickler

Turn the knob and you add powder to the scale pan a granule or two at a time. Brings underweight charges up to accurate readings fast. Solid, stable, low center of gravity.

Weighs a full pound so it won't squirm all over your bench while you are trying to use it. Ideal height for most powder scales.

**NO. 05000 . . . . \$27.90**





# New for 2007!

## Case Neck Gauge *Possibly one of the most important tools you will ever use!*

A quick and easy way to sort cases by neck wall thickness and uniformity. This tool allows you to accurately measure the neck wall thickness of the cartridge case and determine its uniformity, (see below Tech-Talk – Case Neck Uniformity.)

Two mandrel sizes are supplied to allow measurement of all cases from .17 cal. to .338 cal. including cases with small (.060) flash holes. For your convenience the mounting base allows direct attachment to your reloading bench, or use the Redding No. 30520 double “C” clamp (see page 37).

Pilot stops are required for each caliber (see chart below). Two pilot stops are supplied with the tool, #06121, .22 cal. and #06130, .30 cal.

ITEM NO. 26400 Case Neck Gauge complete w/large 1” x .001” dial indicator . . . . \$96.00



### – Tech Talk – Case Neck Uniformity

Uniformity of case neck wall thickness is an indication of the quality of the cartridge case itself. Any large variation (over .0015”) in neck wall thickness will generally indicate a similar or greater variation in the body and shoulder of the case. This variation cannot be corrected and may lead to concentricity and bullet runout problems.

Most competition shooters that have been forced to turn necks to properly fit “tight neck” chambers will confirm the following: “Turning the necks of poor quality cases will not solve the problems associated with the poor uniformity that remains within the shoulder and body of the case.”

As in all handloading practices – uniformity is the key to accuracy.

## Primer Pocket Uniformers

Redding Primer Pocket Uniformers are precision ground carbide tools designed to cut primer pockets to a uniform depth and square to the case head.



The depth of cut is to SAAMI specifications and is controlled by a shoulder ground into the cutter that cannot change.

Available for large and small rifle primer pockets. Each cutter is supplied with an integral holder having a #8-32 threaded shank to fit the Redding #18005 accessory handle.

ITEM NO. 09100 Large Rifle Primer Pocket Uniformer  
with accessory handle . . . . . \$33.00

ITEM NO. 09105 Small Rifle\* Primer Pocket Uniformer  
with accessory handle . . . . . \$33.00

ITEM NO. 09110 Optional – Power Screwdriver Adapter  
(1/4” hex O.D. with #8-32 I.D. threads) . . . . . \$3.60

*\*Note: Small Rifle Primer Pocket Uniformer is dimensionally correct for small pistol. Do not use the Large Rifle Primer Pocket Uniformer for Large Pistol.*

## Flash Hole Deburring Tools

During the manufacturing process, burrs that can cause erratic ignition are often left inside the case at the flash hole.

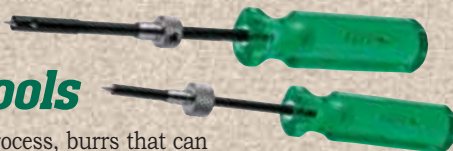

Redding now manufactures two different tools for removal of flash hole burrs. Both tools use pilot stops listed below.

The universal tool is for all calibers from .22 thru .338 cal. using standard (.080”) flash holes. This tool controls the cutting depth with a built-in stop that locates on the inside web of the case. A unique feature of this tool is the cross drilled hole for chip relief. Uses standard pilot stops for 3/16” mandrels.

The small tool is for .17 & .20 cal. and cases with small (.060”) flash holes. This tool *does not* control the cutting depth. The operator must control the cutting depth using the small pilot stops for 9/64” mandrels.

ITEM NO. 06100 Universal Flash Hole Deburring Tool with handle  
(supplied with #06130 .30 cal. pilot stop) . . . . . \$27.90

ITEM NO. 06110 Small Flash Hole Deburring Tool with handle  
(supplied with #06121 .22 cal. pilot stop) . . . . . \$27.90

ITEM NO. 18005 Lg. Accessory Handle with #8-32 thread . . . . \$7.80

ITEM NO. 06103 Sm. Accessory Handle with #6-22 thread . . . . \$7.80



## Stainless Pilot Stops

Precision CNC machined stainless steel for use with the new Redding Case Neck Gauge and Flash Hole Deburring Tools.

Designed to properly fit new and resized case necks, these pilot stops feature a very unique shape. Slightly undercut, this shape will not pick up imperfections at the case mouth or neck/shoulder junction resulting in smooth accurate indicator readings when used with the new Case Neck Gauge.

Two sizes are available because of the small (9/64”) mandrels used for .17 & .20 cal. and small flash holes. The larger size (for standard 3/16” mandrels) work equally well with the tools of other manufacturers.

ITEM NO.	CALIBER	ITEM NO.	CALIBER	ITEM NO.	CALIBER
06117	.17 CAL.*	06124	6MM	06130	.30 CAL.
06120	.20 CAL.*	06125	.25 CAL.	06131	.31 CAL.
06121	.22 CAL.*	06126	6.5MM	06132	8MM
06122	.22 CAL.	06127	.270 CAL.	06133	.338 CAL.
06123	6MM*	06128	7MM		

\* Pilots for small diameter 9/64” mandrels

ITEM NO. 061XX Stainless Pilot Stop . . . . \$6.90 ea.

**The new T-7 combines strength, power and convenience with the speed and versatility of a turret press.**

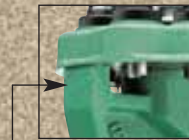

Rear casting support assures a rigid turret and precise alignment.



**Features:**

- Seven station turret head with operating handle
- Heavy duty cast iron frame for strength and wear resistance
- Powerful compound linkage with positive ram stop.
- 1" diameter ram
- 4-3/4" press opening
- 3-13/16" ram stroke
- Ball handle
- "Spent primer collection system"
- Accepts all standard 7/8"-14 threaded dies and universal shell holders
- Shellholders may be rotated to any comfortable position desired
- "Smart" primer arm for seating small and large primers
- Interchangeable turret heads
- Competition die compatible

**"Cast iron construction, powerful compound linkage and a rigid seven station turret combine to make the new Redding T-7 the best turret press ever!"**

## The T-7 Turret Reloading Press

The design criteria was to create the ultimate turret press. Our engineering team started with our time proven cast iron construction and turret support that is second to none. They added powerful compound linkage with over 3.8" of ram travel. A 1" diameter hollow ram was chosen with the "smart primer arm" and "spent primer collection system" borrowed from our Ultramag. Another station was added to the turret for even greater versatility and an optional "Slide Bar Automatic Primer Feeding System" was designed.

After adding a few more subtle refinements and built with the precision you would expect from Redding, we're confident this is the best turret press ever.

*Shown with optional "Slide Bar Automatic Primer Feeder System". Also fits the new Big Boss Press. See below for details.*

**ITEM NO. 67000 . . . . . \$357.00**

**Buy the Kit, Save  on Dies and Shellholder**

**Also available in kit form: Includes press, shellholder, and your choice of any Series "A" full length die set.**  
**ITEM NO. 67XXX . . . . . \$406.50**

*For Order No., replace XXX with the last three numbers from the Series "A" dies, see chart on page 9.*

### Slide Bar Automatic Primer Feeding System

Eliminates handling of primers during sizing, and speeds-up reloading operations. Comes complete with individualized tubes for both large and small primers. Capacity: approximately 100 primers. Fits the T-7 and Big Boss Presses.

**ITEM NO. 99600 . . . . . \$52.50**



### Extra Slide Bar Primer Arm Assembly

This item allows you to quickly change primer cup & pin sizes by simply replacing the slide bar assembly on your Automatic Primer Feeder. Includes slide bar, knob, spring and large & small primer arm assemblies.

**ITEM NO. 99585 . . . . . \$16.50**



** New!**

*This top of the line single station press has the largest window opening and longest usable ram stroke of any press in its class.*

## **The Big Boss II** **and original Big Boss Reloading Presses**

Both the original Big Boss and the new Big Boss II reloading presses have all the desirable features of the "Boss" reloading press, but are built on heavier frames with a 1" diameter ram and longer 3.8" usable ram stroke for reloading the largest magnum cartridges.

The Big Boss II now features the unique Redding "Spent Primer Collection System" used on the T-7 and Ultramag presses. This top of the line single station press has the largest window opening and longest usable ram stroke of any press in its class. Simply, the only press you will ever need!

**ITEM NO. 97000 Big Boss II . . . . . \$229.50**

**ITEM NO. 79000 Big Boss . . . . . \$205.50**

*(Original Big Boss Press is supplied with "Boss" style primer catcher.)*

**Buy the Kit, Save  on Dies and Shellholder**

*Also available in kit form: Includes press, shellholder, and your choice of any Series "A" full length die set.*

**ITEM NO. 97XXX Big Boss II . . . . . \$279.00**

**ITEM NO. 79XXX Big Boss . . . . . \$255.00**

*For Order No., replace XXX with the last three numbers from the Series "A" dies. see chart on page 9.*

*Optional bushing for 1"-14 threaded dies*

**ITEM NO. 70030. . . . . \$19.50**

### **"Spent Primer Collection System"**

Spent primers automatically drop through the large diameter hollow ram into a handy flexible plastic tube that can hold hundreds of spent primers before emptying, or be easily routed to your trash container.



### **"Smart Primer Arm"**

"Smart" primer arm automatically swings into position during the ram stroke and flips out of the way when not in use. For maximum sensitivity at the lowest possible leverage, priming is done at the end of the ram stroke.



## **The Big Boss II – with "Spent Primer Collection System"**

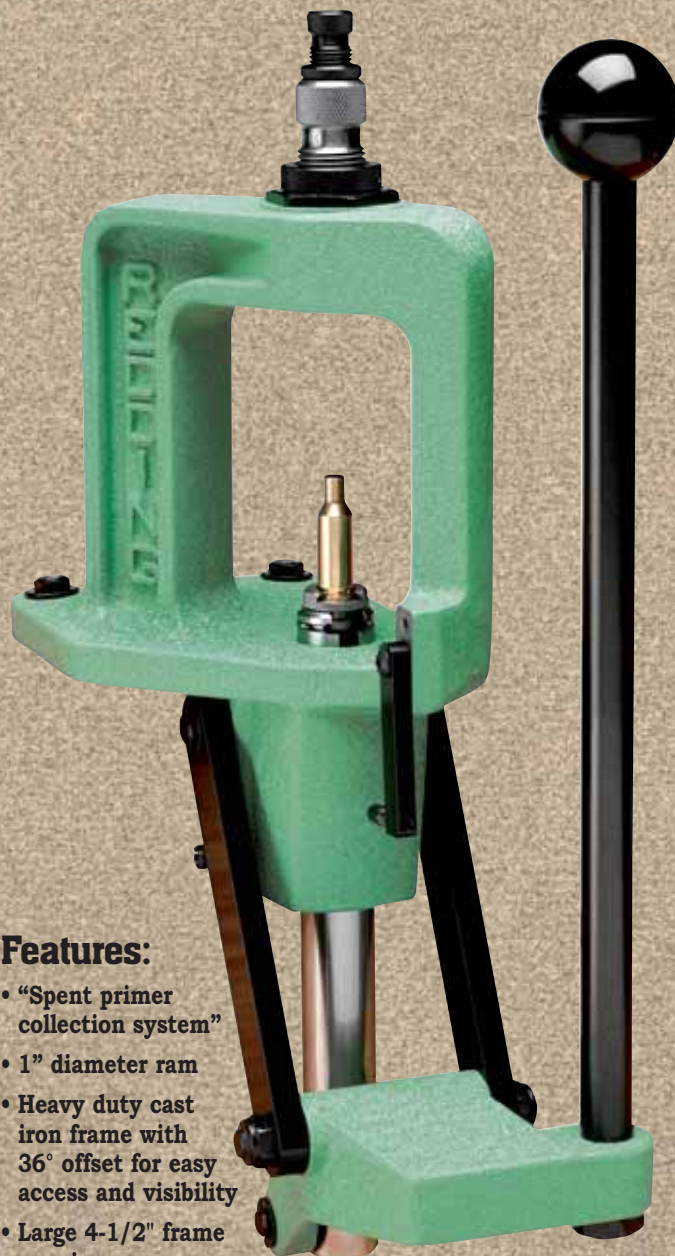

### **Features:**

- "Spent primer collection system"
- 1" diameter ram
- Heavy duty cast iron frame with 36° offset for easy access and visibility
- Large 4-1/2" frame opening
- 3-3/16" of ram stroke for easy reloading of magnum cartridges
- Offset/straight pull ball handle for ease of operation
- "Smart" primer arm that moves in and out of position with ram travel
- Heavy duty compound linkage
- Steel adapter bushing accepts all standard 7/8"-14 threaded dies and is removable for use with oversized dies
- Frame with bushing removed accepts 1-1/4" - 12 dies



**The Quality of Cast Iron at  
The Price of Aluminum!**

# The Boss Reloading Press

Here is the press that has all the features reloaders look for. It's cast iron construction insures that it will last a lifetime, yet it is priced with light-duty aluminum presses! The BOSS is powerful, remarkably easy to use, and yet sensitive enough to seat primers without crushing them.

Take a look at all the features The BOSS offers and you'll be convinced...when it comes to "O" Type reloading presses, this one is truly a smart choice.

**ITEM NO. 72100 . . . . . \$165.00**

**Buy the Kit, Save  25% on Dies and Shellholder**

**Also available in kit form: Includes press, shellholder, and your choice of any Series "A" full length die set.**

**ITEM NO. 72XXX . . . . . \$214.50**

For Order No., replace XXX with the last three numbers from the Series "A" dies, see chart on page 9.

## Features:

- Rigid cast iron frame
- 36" frame offset gives the best visibility and access of all comparable presses
- "Smart" primer arm automatically moves in and out of position with ram travel. Priming arm is positioned where it should be...at the bottom of ram travel for the lowest leverage and best feel
- Offset handle is in the most comfortable operating position yet out of the way for best access and visibility
- Positive ram travel stop
- Powerful compound linkage
- 3 holes for rigid mounting
- Accepts all standard 7/8"-14 threaded dies and universal shellholders
- Shellholders may be rotated to any comfortable position desired
- Includes primer catcher



*"I recently won the 2005, 1000 yd. Porter Cup Trophy Match at Camp Perry. All of my ammunition was loaded with Redding Competition dies on Redding presses and checked with your Instant Indicator. Having piece of mind that all of my ammunition is identically engineered for top performance is critical at these extreme ranges.*

*Thanks for all of your efforts and keep up the great work."  
- Scott Anzivino*



## Ball Handle Conversion

Convenient, easy-to-attach conversion for those who prefer a ball handle on their reloading press. Fits the Redding BOSS and other reloading presses that use a 5/8" handle diameter. Easily attaches without machining or threading.

**ITEM NO. 99175 . . . . . \$8.10**

**“The largest and strongest press available for the toughest reloading chores...”**

*(HANDLOADER Magazine, No. 148)*

## **The Ultramag Reloading Press**

At first glance you will see what sets the ULTRAMAG apart from all other reloading presses: the unique location of its compound leverage system. Unlike other reloading presses which connect the linkage to the lower half of the press, the ULTRAMAG'S leverage system is connected to the top of the press frame. This allows you to develop literally tons of pressure without the usual concern about press frame deflection or misalignment.

The ULTRAMAG features a huge 4-3/4" frame opening and 4-1/8" of usable ram stroke, making it ideal for loading oversized cartridges such as the old Sharps "Buffalo Cartridges" and British "Nitro-Express" rounds.

Its unique long link compound leverage system has more mechanical advantage over a greater distance than any other reloading press on the market. This makes "childs play" of difficult case forming operations.

ITEM NO. 70000 . . . . . \$372.00

**Buy the Kit, Save  25% on Dies and Shellholder**

*Also available in kit form: Includes press, shellholder, and your choice of any Series "A" full length die set.*

ITEM NO. 70XXX . . . . . \$421.50

*For Order No., replace XXX with the last three numbers from the Series "A" dies, see chart on page 9.*

• **Optional bushing for 1" - 14 die threads is also available.**

ITEM NO. 70030 . . . . . \$19.50



### **“Smart Primer Arm”**

“Smart” primer arm automatically swings into position during the ram stroke and flips out of the way when not in use. For maximum sensitivity at the lowest possible leverage, priming is done at the end of the ram stroke.



### **“Spent Primer Collection System”**

Spent primers are automatically collected in the large diameter hollow ram. They then drop into a handy flexible plastic tube that can hold hundreds of spent primers before emptying, or be easily routed to your trash container.



### **Features:**

- The frame is constructed of high grade cast iron for strength, long life and wear resistance
- Four mounting holes provide rigid mounting
- Offset handle is out of the way for all reloading operations
- All linkage pins are heat treated, precision ground and in double shear
- Steel adapter bushing accepts standard 7/8"-14 threaded dies and is removable for use with oversized dies
- Frame with bushing removed accepts 1-1/4" - 12 die threads
- "Smart" primer arm that moves in and out of position with ram travel
- “Spent primer collection system”

# Pro-Pak Reloading Kits



## “An Investment in Quality Tools.”

We've selected our best reloading components and put them into one neat, money-saving package. This kit was created for both the first-time reloader to get started right and for the more advanced reloader desiring to upgrade his equipment.

The Boss and Big Boss Pro-Paks contain the following:

- The Boss or Big Boss Reloading Press – Our best selling presses.
- Model 2 Powder and Bullet Scale. Simply the most sensitive, most accurate scale on the market.
- Powder Trickler – Heavy stable companion to the powder scale.
- Pad Style Case Lube Kit– Consists of our non-skid lube pad and our best case lube.
- Deburring Tool– The cutting edges are ground correctly for clean chatterless cuts.
- Model 18 Case Preparation Kit – Plastic accessory handle with all the tools and brushes you need to properly clean your fired cases before resizing.
- Powder Funnel– Made of tough Lexan® and nearly indestructible.
- Metallic Cartridge Reloading – All new 3rd Edition. A single source for detailed information on advanced handloading issues, while offering a wide variety of loading data.

<b>BOSS PRO-PAK</b>	
NO. 20000 .....	\$369.00
<b>BIG BOSS PRO-PAK</b>	
NO. 40000 .....	405.00

## Also available with Dies & Shellholder

- Add a set of series “A” reloading dies and matching shellholder of your choice.

<b>BOSS PRO-PAK W/DIES</b>	
NO. 20XXX .....	\$429.00
<b>BIG BOSS PRO-PAK W/DIES</b>	
NO. 43XXX .....	465.00

For Order No., replace XXX with the last three numbers from the Series “A” dies, see chart on page 12.

## Pro-Pak Deluxe Reloading Kit



Now you can upgrade your Boss or Big Boss Pro-Pak by adding our most popular Model #3BR Powder Measure and Model #1400-XT Case Trimming Lathe.

<b>Boss Pro-Pak Deluxe Reloading Kit</b>	
ITEM NO. 20500 .....	\$666.00
<b>Big Boss Pro-Pak Deluxe Reloading Kit</b>	
ITEM NO. 45000 .....	705.00

## **New!** Pro-Pak Plus Reloading Kit

Contains all the components of our Pro-Pak, plus the original Redding Model 3 Powder Measure.

<b>Boss Pro-Pak Plus</b>	
ITEM NO. 20400 .....	\$517.50
<b>Big Boss Pro-Pak Plus</b>	
ITEM NO. 40400 .....	\$555.00

Note: Deluxe and Pro-Pak Plus Reloading kits are available only without dies and shellholder.

# Model 2400 Match Precision Case Trimming Lathe

The most noteworthy feature of the new Model #2400 Case Trimming Lathe is the new Micrometer which adds precision and repeatability to the case length adjustment. Changes as little as .001" can be easily "dialed in".

The innovative new push button chuck lock simplifies loading and unloading while facilitating perfect alignment of the case and pilot. The design of the new push button chuck lock, combined with the extended cast iron frame of the Model #1400-XT, increases case length capacity; accommodating not only the latest long action cartridges but old time classics as well.

**ITEM NO. 24000 . . . . . \$198.00**

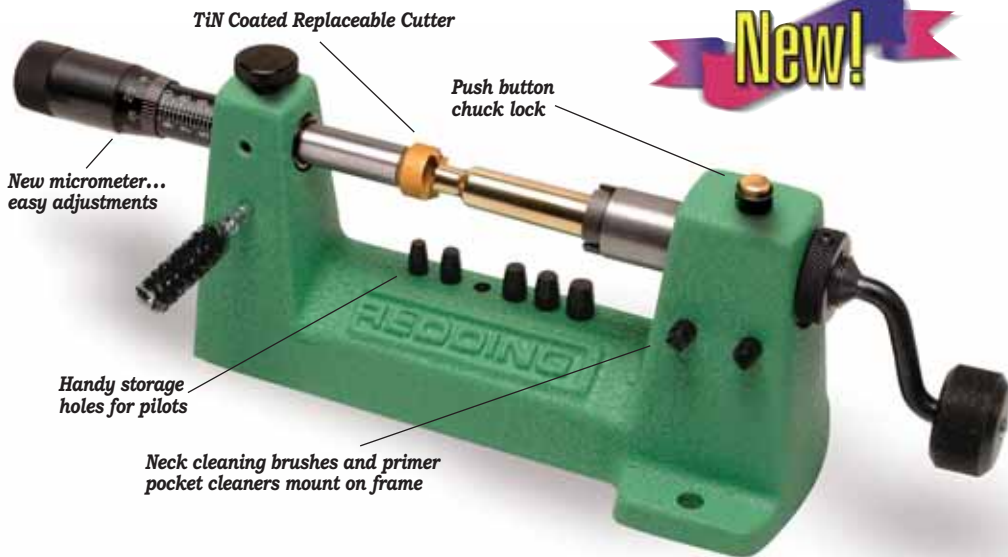

**New!**

### Model 2400 features:

- New micrometer...easy adjustments of .001".
- Cast iron frame to maintain precision alignment.
- New push button collet chuck is ideally suited for use with optional power adapter.
- Handles up to 3-1/4" case length.
- Universal collet fits all popular cases – no others to buy.
- TiN (Titanium Nitride) coated replaceable cutter.
- Storage holes for pilots.

# Model 1400-XT Case Trimming Lathe

The Model #1400-XT Case Trimming Lathe uses a cast iron frame that has been extended to handle all the latest long action cartridges. The frame is cast iron because it is a perfect bearing surface, will not wear out and will maintain its precision and alignment for years of service.

This case trimmer was designed using precision lathe principles. The TiN coated cutter is held stationary while the case is turned; this produces cases that are perfectly square, resulting in increased accuracy from your handloads.

**ITEM NO. 14000 . . . . . \$ 115.50**

**Redding "case trimming lathes" are the only case trimmers on the market that turn the case and not the cutter. This feature guarantees a perfectly square case mouth with every cut.**

**Both the Model #1400-XT and the #2400 Case Trimming Lathes are supplied with the following:**

- Universal collet (no others to buy)
- Replaceable Titanium Nitride (TiN) coated cutter
- Six pilots - .22 cal., 6mm, .25 cal., .270 cal., 7mm and .30 cal.
- Two neck cleaning brushes (.22 thru .30 cal.)
- Large and small primer pocket cleaners.



**"Thank You! The New 2400 Case Trimming Lathe is another "Home-Run" for Redding. Your equipment is very well thought out."**

**- Rich Maretzo  
Precision Shooting Inc.**

### Model 1400-XT features:

- Cast iron frame to last a lifetime.
- Universal collet fits all popular cases – no others to buy.
- Handles 3" case length with ease.
- New replaceable cutter with TiN (Titanium Nitride) surface treatment.
- Coarse and fine adjustments for case length.
- Storage holes for pilots.



**3/16" Shank Pilots may also be used on Hornady and Forster trimmers.**



**Universal Collet accepts all popular cases – no others to buy!**



**New replaceable (TiN) Titanium Nitride coated high speed cutters.**



**Optional Power Adapter with 1/4" hex for use with cordless screwdrivers.**

**ITEM NO. #14025 . . . \$12.60**

**ITEM NO. 14040 TiN Cutter (17 & 20 caliber)\* . \$ 25.80**

**ITEM NO. 14045 TiN Cutter & Shaft Complete . . 33.00**

*Item number 14045 assembly fits only Model 14 & 1400 Trimmers*

**ITEM NO. 14050 TiN Cutter (Standard) . . . . . 25.80**

**ITEM NO. 15XXX Pilots . . . . . 5.10**

*Refer to die reference chart on pages 16, 17 & 18 for pilot sizes.*

\* Note: Our 17 and 20 caliber pilots have a 5/32" shank, therefore, our #14040 cutter will interchange with RCBS.

# Imperial Lubricants – now produced by Redding



**Imperial Lubricants are the latest addition to the Redding product line and are now produced at the Redding facility.**

Imperial Sizing Die Wax is the most recognized product of the line. Because of its superior performance and ease of application and cleanup, this product has been a favorite of knowledgeable reloaders for years. Redding is committed to maintaining the integrity of this product by producing it to the exact formulation that made it so popular.

Imperial Dry Neck Lube is the perfect lube for those who neck size. This product can be used inside and outside the case neck, reducing the drag on both the die and size button without concern about powder contamination.

The newest Imperial product is Imperial Action Wax. Action Wax is another paraffin based product that was formulated to reduce friction on rifle, pistol and shotgun actions. Its stay-put disposition and anti-galling characteristics make it ideal for sliding metal to metal surfaces. For use on hammers/sears, auto slides, slide bars, action raceways, cocking cams, locking lugs and any place where sliding friction is present.

## Imperial Dry Neck Lube

For use inside and outside the case neck to reduce drag on both the die and size button without concern of powder contamination.

Packaged in 1 oz. container.

**ITEM NO. 07700 . . . . . \$5.40**



- ITEM NO. 07500 Imperial Sizing Die Wax, 1 oz. . . . . \$6.30**
- ITEM NO. 07600 Imperial Sizing Die Wax, 2 oz. . . . . 9.30**
- ITEM NO. 07700 Imperial Dry Neck Lube, 1 oz. . . . . 5.40**
- ITEM NO. 07800 Imperial Action Wax, syringe . . . . . 6.60**

## Redding brand of Imperial Sizing Die Wax

The original non-liquid sizing die lube is now available from Redding. True to the original LeClear product of the 70's – green in color. Packaged in 1 oz. tins.

**ITEM NO. 21022 (1 oz. tin) . . . . . \$6.30**

## Imperial Action Wax

Formulated for rifle action raceways, bolt lugs, pistol hammers/sears, auto slides, shotgun slide bars, and/or any place where sliding friction is present.

**ITEM NO. 07800 Syringe . . . . . \$6.60**

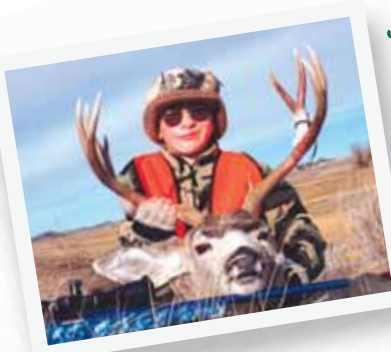

**Jonathan Holland, son of Darrell Holland, Holland's Custom Rifles, Powers, Oregon. This boy is already using Redding Reloading Equipment. Congratulations Jonathan – nice buck!**

## Imperial Sizing Die Wax

“The original” - a favorite among discriminating reloaders. Packaged in 1 oz. & 2 oz. tins.

- ITEM NO. 07500 (1 oz. tin) . . . . \$6.30**
- ITEM NO. 07600 (2 oz. tin) . . . . \$9.30**





# SAECO – a product of Redding Since 1985

Considered by many to be the finest lubricator/sizer available today.

## SAECO Lubri-Sizer

A single stroke seats the gas check, swages the bullet to proper diameter, and lubricates it. SAECO's Lubri-Sizer features a pressurized reservoir that lubricates from 20 to 50 bullets between turns of the lube control handle. Two precision parallel guide rods assure proper alignment of the top punch and sizing die, resulting in maximum bullet concentricity.

Those who prefer to shoot bullets "as cast" will appreciate SAECO's exclusive swing out gas check seater which allows the option of seating gas checks without sizing.

A combination of compound leverage and extra length operating handle substantially reduces physical effort. Sizing Dies and Top Punches are not included and should be ordered separately according to caliber and bullet design.

ITEM NO. 30000 . . . . . \$237.00



- Features:**
- Solid cast iron body
  - Swing Out Gas Check Seater
  - Adjustable Pressure Lubricant
  - Precise alignment
  - Can be used with either hollow or solid stick lube.



### Top Punches

SAECO's exclusive tapered shoulder assures positive alignment with die body. A single Top Punch may be used interchangeably with several bullets of similar design. See Mould Table for top punch number . . . . . \$18.00



### Top Punches Lyman/RCBS Type

Straight shank type top punches designed to fit the Lyman and RCBS Lubrisizers and SAECO bullets. See mould table for top punch number. . . . . \$18.00

### WARNING:

Melting lead and casting lead objects will expose you and others in the area to lead, which is known to cause birth defects, other reproductive harm and cancer. See instructions on Reducing Exposure supplied with product.

## SAECO Sizing Dies

SAECO sizing dies are made with a unique prelead that fits the "as cast" bullet diameter for a depth of approximately .3 inch. This special entrance throat insures that the bullet feeds into the sizing diameter in absolute straight alignment. The constriction between the two diameters is a gentle taper which eliminates lead shearing and sizes the bullet concentrically. The dies are finished by internal honing known as micro-finishing which produces a mirror like finish and a sizing hole that is perfectly round. Your bullets will look like polished silver with no lead shavings. . . . . \$43.50



#### DIE SIZES AVAILABLE:

- .224 .225 .244 .251 .258 .265 .266 .278 .285 .286 .308 .309 .310 .311 .312  
 .313 .314 .321 .322 .323 .324 .325 .338 .339 .349 .354 .355 .356 .357 .358  
 .359 .360 .364 .365 .366 .375 .376 .377 .378 .401 .408 .409 .410 .411 .417  
 .427 .428 .429 .430 .431 .451 .452 .454 .455 .458 .459 .460

**A precision instrument to accurately determine the hardness of a bullet casting alloy.**

# SAECO Lead Hardness Tester



US Patent No. 3,524,343

A SAECO Lead Hardness Tester will pay for itself many times over by allowing you to convert inexpensive scrap lead of unknown composition into casting alloy of known and reproduceable hardness. It provides a standard by which you can check the quality of purchased cast bullets. The SAECO Lead Hardness Tester measures alloy hardness by determining the depth of penetration of a hardened steel indenter into a bullet. Relative hardness of the bullet is read off a vernier scale.

	Relative Hardness	
	SAECO	Brinell (Approx.)
Pure lead	0-1	5
1:20 tin: lead	6-7	10
5:5:90 tin: antimony: lead		
2:6:92 (taracorp) (magnum alloy)	8-9	16-17
5:10:85 (linotype)	9-10	22

The vernier scale is calibrated in arbitrary units from 0 for pure lead up to a SAECO hardness of 10. We have found that a SAECO hardness of at least 6 is required for medium velocities in handguns and a SAECO hardness of over 8 for Magnum handgun and gas check rifle bullets. As a point of reference, wheelweights vary in composition and hardness but usually test between 7 and 9, while linotype registers approx. 10.

**ITEM NO. 42000 . . . . . \$183.00**

## SAECO Bullet Lubricant

### SAECO GOLD

Pistol Lubricant. The original alox free formula developed by SAECO. Keeps barrels cleaner and reduces leading to a minimum for superior accuracy. Also makes an excellent fluxing agent and works equally well in rifles.

### SAECO TRADITIONAL

Rifle Lubricant. This is the NRA formula for Alox and bees wax. We use natural yellow beeswax, not synthetics. Formulated to prevent leading and improve accuracy at higher velocity levels.

### SAECO GREEN

Rifle and Pistol Lubricant. An original SAECO formula brought back. Contains no alox. Slightly harder than the other SAECO lubes.

**Available in Solid or Hollow Sticks . . . \$6.00 each**

### SPG BLACK POWDER LUBE

SPG black powder bullet lube has been specially formulated by experienced black powder cartridge shooters to minimize leading and keep the powder fouling soft.

Extensive testing has shown this to be the key to accuracy in black powder cartridges.

**ITEM NO. 37007 . . . . . \$7.50**

## “Magnum” Mould Blocks

We created “Magnum” mould blocks to insure more uniform temperature control and casting consistency when casting large diameter and/or heavy bullets. Single cavity MAGNUM moulds are made from our normal double cavity blocks. Double cavity MAGNUM moulds are made from our normal triple cavity blocks, with wider spacing.

“Magnum” moulds can be ordered for any caliber or weight bullet and are required for those moulds marked with asterisk\*.

**Magnum Single Cavity . . . . . \$ 97.50**

**Magnum Double Cavity . . . . . 132.00**



## WARNING:

Melting lead and casting lead objects will expose you and others in the area to lead, which is known to cause birth defects, other reproductive harm and cancer. See instructions on Reducing Exposure supplied with product.

# SAECO Precision Bullet Moulds

All SAECO moulds are machined from solid cast iron blocks one cavity at a time. Using the same cutting tool (cherrie) for each cavity on digital equipment guarantees that each cavity duplicates the previous one. You don't need to pay a premium for matched cavities. SAECO even developed its own blend of copper alloyed pearlitic cast iron for tight grain structure, dimensional stability and extended life. The steel sprue plates are held firm against the mould blocks by high-temperature spring washers to insure uniform bullets with square bases.

Mould handles are ductile iron castings with solid hardwood grips. They should be ordered separately and fit all SAECO mould blocks (1-8 cavity).

Mould Handles

ITEM NO. 29000 . . . . . \$49.50

- 1 Cavity "MAGNUM" . . . . . \$ 97.50
- 2 Cavity . . . . . 112.50
- 2 Cavity "MAGNUM" . . . . . 132.00
- 4 Cavity . . . . . 186.00

### SPECIAL ORDER MOULDS

All 3 cavity moulds are made on a special order basis only. Because of the nature of the work involved, special order moulds require advance payment with the order, NO C.O.D.'s. Delivery usually takes 6-8 weeks.

3 Cavity . . . . . \$ 148.50

### SPECIAL COMBINATIONS

of different mould numbers cut in the same block, add . . . . . \$25.50



## Traditional Bullet Moulds

For Black Powder Cartridges & Cowboy Action Shooting

All SAECO bullet moulds must be ordered with the SAECO bullet number. Illustrations not to scale.

	30 CAL. RIFLES		32-20 WIN	32-40 WIN		38 SPL/ 357 MAG	38-40 WIN	38-55 WIN		
No.	630	315	322	632	*732	358	401	638	738	*571
Designation	140gr. FP	175gr. TCGC	118gr. RNFP	165gr. RNFP	200gr. RNFP	158gr. RNFP	190gr. RNFP	225gr. RNFP	255gr. RNFP	300gr. RNFP
Sizing Die	.309	N.R.	.313	N.R.	N.R.	.358	.401	N.R.	N.R.	N.R.
Top Punch	30530	30329	30254	30530	30530	35353	40101	37570	37570	37570
LR Top Punch	46511	46509	46507	46511	46511	46518	46531	46528	46528	46528
Description	For 30-30	Bench Rest •Tapered	.32-20 Bullet	.32-40 •Tapered	.32-40 •Tapered	Super Long Range Bullet	.38-40	•Tapered	•Tapered	•Tapered
	40 CAL. RIFLES		44-40 WIN	44 SPL/44 MAG		45 COLT		45 CAL. RIFLES		
No.	*640	*740	444	446	429	954	955	*645	*745	*881
Designation	370gr.	410gr.	200gr. RNFP	200gr. RNFP	240gr. RNFP	230gr. RNFP	255gr. RNFP	480gr.	525gr.	500gr. RN
Sizing Die	.408/.410	.408/.410	.428	.430	.430	.452/.454	.452/.454	.458/.460	.458/.460	.458
Top Punch	40410	40410	44191	44191	44191	45424	45424	45525	45525	45525
LR Top Punch	46532	46532	46538	46538	46538	46550	46550	46553	46553	46553
Punch			.44-40		.44 Spec/Mag					M1881 Design







































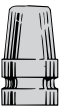
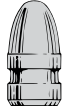
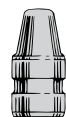
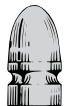

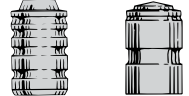









• Tapered Styled Bullets have the front band near bore diameter tapering to slightly larger than groove diameter. This style bullet was furnished by most of the old time barrel makers such as Harry Pope. This is a popular Schuetzen style bullet with rounded lube grooves.

# SAECO Bullet Moulds

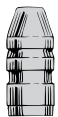
All SAECO bullet moulds must be ordered with the SAECO bullet number. Illustrations not to scale.

## WARNING:

Melting lead and casting lead objects will expose you and others in the area to lead, which is known to cause birth defects, other reproductive harm and cancer. See instructions on Reducing Exposure supplied with product.

													
<b>No.</b>	221	243	257	264	270	281	070	071	073		302	254	316
<b>Designation</b>	60gr. SPGC	85gr. TCGC	100gr. TCGC	140gr. SPGC	140gr. TCGC	145gr. FPGC	145gr. TCGC	160gr. TCGC	165gr. SPGC		120gr. RNGC	115gr. RNBB	150gr. FPGC
<b>Sizing Die</b>	.225	.244	.258	.265	.278	.285	.285	.285	.285		.309	.309	.309
<b>Top Punch</b>	22498	24243	25258	26264	27273	28311	28520	28520	28520		30467	30467	30530
<b>LR Top Punch</b>	46500	46501	46502	46503	46504	46505	46506	46506	46506		46510	46510	46511
<b>Description</b>	Works Well in .223 Semi Autos	For all .243 & .244 Cal.	.25 Cal. Silhouette		Two perfect 60's shot at Reg. 6 IHMSA	Standard for 7mm	Silhouette	200 meters Silhouette	Heavy 7mm Bullet		For 30 MI, GC	For 30 MI	For 30-30
													
<b>No.</b>	311	307	301	305	323	325	326	321		081	922	925	
<b>Designation</b>	165gr. TCGC	180gr. FPGC	196gr. TCGC	180gr. FPGC	95gr. WC	95gr. SWC	100gr. SWCBB	95gr. RN		190gr. RNGC	115gr. RNBB	115gr. SWCBB	
<b>Sizing Die</b>	.309	.309	.309	.311	.313	.313	.313	.313		.323/.324	.356	.356	
<b>Top Punch</b>	30301	30530	30301	30530	32323	32467	32467	32465		32467	35311	35925	
<b>LR Top Punch</b>	46508	46511	46508	46511	46512	46514	46514	46513		46514	46516	46526	
<b>Description</b>			Duplicates Original RG4	303 British	.Good .32 Long Target Bullet			.32 S&W Long		8 mm Rifle			
													
<b>No.</b>	377	384	115	924	383	928	929	910	930	940	052	053	
<b>Designation</b>	122gr. TCBB	122gr. RN	122gr. RNBB	124gr. SWCGC	140gr. SWC	145gr. RNBB	145gr. SWCBB	150gr. RN	154gr. SWCBB	100gr. RNBB	148gr. WCBB	148gr. WC	
<b>Sizing Die</b>	.356	.356	.356	.356	.356/.357	.356/.357	.356/.357	.356	.356/.357	.365	.358	.358	
<b>Top Punch</b>	35375	35311	35311	35925	35429	35311	35925	35311	35925	35465	35550	35381	
<b>LR Top Punch</b>	46519	46516	46516	46526	46522	46516	46526	46516	46526	46524	46525	46520	
<b>Description</b>	Good Ballistics for 9 mm	Good Feeding 9mm		Good Feeding SWC		38 Super	38 Super		38 Super Wilson Design	9mm Makarov	Target Bullet	GAR Design	
													
<b>No.</b>	397	348	382	388	393	390	391	398	353	354	396	399	351
<b>Designation</b>	148gr. WCDBB	148gr. DBBWC	158gr. SWC	158gr. SWCBB	162gr. SWCGC	158gr. RN	158gr. RNBB	158gr. TC	180gr. FP	180gr. FPGC	180gr. TC	180gr. TCGC	200gr. FP
<b>Sizing Die</b>	.358	.358	.358	.358	.358	.358	.358	.358	.358	.358	.358	.358	.358
<b>Top Punch</b>	35344	35344	35429	35429	35429	35311	35311	35399	35353	35353	35399	35399	35399
<b>LR Top Punch</b>	46517	46517	46522	46522	46522	46516	46516	46521	46518	46518	46521	46521	46516
<b>Description</b>	148gr. Double Bevel Base WC	Single Groove DBB	Keith Design	Most Popular		Standard .38 Bullet			Super Long Range Bullet	GC Version of Popular 353			Heavy 357 Bullet
													
<b>No.</b>	356	395	352	373	040	043	045	047	048	416	419		
<b>Designation</b>	200gr. FPGC	200gr. TCGC	245gr. FPGC	265gr. FPGC	155gr. SWCBB	170gr. TCBB	170gr. SWCBB	200gr. TCBB	200gr. SWCBB	170gr. SWCBB	200gr. SWCBB		
<b>Sizing Die</b>	.358	.358	.358	.376	.401	.401	.401	.401	.401	.411	.411		
<b>Top Punch</b>	35353	35399	35399	37570	40048	40047	40048	40047	40048	41447	41447		
<b>LR Top Punch</b>	46516	46521	46516	46528	46530	46529	46530	46529	46530	46535	46535		
<b>Description</b>	Handgun Silhouette	Silhouette		Rifle	10mm Auto	10mm Auto	10mm Auto	10mm Auto	10mm Auto	41 Auto Petty Design	41 Auto Petty Design		

41 CAL. (continued)							44 CAL.				
No.	412	417	409	413	415	410	418	944	420	445	442
Designation	185gr. SWC	210gr. SWC	190gr. TC	210gr. TCBB	220gr. TCGC	220gr. FP	220gr. SWCBB	200gr. WC	200gr. TC	220gr. SWCBB	246gr. RN
Sizing Die	.411	.411	.411	.411	.411	.411	.411	.430	.430	.430	.430
Top Punch	41610	41610	41415	41415	41415	41415	41610	44944	44428	44191	44374
LR Top Punch	46536	46536	46534	46534	46534	46534	46536	46544	46542	46538	46540
Description						Pistol Silhouette	Bevel Base Keith Style	GAR Design	Jim Hubert Design		Standard 44 Spec. Bullet

45 CAL.												
No.	441	440	439	429	424	428	431	430	432	433	063	062
Designation	240gr. SWC	240gr. SWCBB	240gr. SWCGC	240gr. FP	240gr. TCGC	240gr. TC	250gr. FPGC	265gr. FP	265gr. FPGC	300gr. FPGC	160gr. SPL	170gr. SPLBB
Sizing Die	.430	.430	.430	.430	.430	.430	.430	.430	.430	.430	.452	.452
Top Punch	44421	44421	44421	44191	44428	44428	44191	44191	44191	44191	45452	45452
LR Top Punch	46541	46541	46541	46538	46542	44542	46538	46538	46538	46538	46552	46552
Description	Standard Wt. 44 Mag Keith Style			Superb Long Range Bullet	GC Version of Popular 428	Most Popular Silhouette	444 Marlin	Superb Long Range Bullet	Silhouette		Behn Design	-V-MAXX .45 Behn Design

No.	065	130	131	066	068	069	058	265	067	456	457
Designation	180gr. SWCBB	185gr. SWC	185gr. SWCBB	180gr. SWC	200gr. SWCBB	200gr. SWC	215gr. SWCBB	210gr. RNWC	225gr. TCBB	225gr. RN	225gr. RNBB
Sizing Die	.452	.452	.452	.452	.452	.452	.452	.452	.452	.452	.452
Top Punch	45429	45421	45421	45429	45429	45429	45424	45265	45375	45701	45701
LR Top Punch	46551	46549	46549	46551	46551	46551	46550	46547	46548	46556	46556
Description	Lt. Wt. IPSC	Most Popular Lt. Target			Most Popular Combat Bullet		Bowling Pin Bullet	Best Feeding .45 ACP		Standard Round Nose	

45 CAL. RIFLE													
No.	453	945	458	452	454	015	*017	*018	*019	*023	*021	*022	*020
Designation	225gr. WC	255gr. SWCGC	255gr. SWC	255gr. SWC	300gr. SWCGC	300gr. FP	350gr. FPGC	405gr. FP	465gr. FPGC	375gr. SP	405gr. SPGC	500gr. FP	540gr. FPGC
Sizing Die	.452	.452	.452	.455	.452	.458	.458	.458	.458	.458	.458	.458	.458
Top Punch	45424	45424	45424	45424	45424	45015	45015	45015	45015	45702	45702	45525	45525
LR Top Punch	46550	46550	46550	46550	46550	46545	46545	46545	46545	46557	46557	46553	46553
Description	Jan Libourel Design	For 45 Colt	For 45 Colt w/.452 Bore	For 45 Colt w/.454 Bore	Heavy .45 Colt & 454 Casull								

\* Due to length, diameter or weight, the moulds indicated are available in "MAGNUM" mould blocks only.

## Bullet Sizes & Weights – How to Vary Them

The bullet diameters and weights presented in this list are based on the use of Taracorp's Lawrence Magnum bullet alloy (2% tin, 6% antimony, 1/4% arsenic, 91.75% lead).

Bullet diameters and weights will vary considerably depending on the lead casting alloy used. This variation can be as much as 1/2% on the diameter, and 8% on the weight among the most commonly used casting alloys. For example, a .358-158 grain bullet might show a diameter variation of .002", and a 13 grain difference in weight.

Of the most commonly used alloys, wheel weights (.5% tin, 4% antimony, 95% lead) will produce bullets having the smallest diameter and heaviest weight, with such bullets running approximately .3% smaller in diameter and 3% heavier than bullets cast with Taracorp's metal. Linotype will produce bullets with the largest diameter and lightest weights. This alloy will

produce bullets approximately 1/10% larger and 3% lighter than Taracorp. Other alloys of tin and antimony, with antimony content above 5%, will produce bullets with diameters and weights falling between those cast from wheel weights and linotype.

Alloys containing little or no antimony will cast considerably smaller than wheel weights and in some cases will produce bullets too small for adequate sizing. Within the limitations given above, the weight and diameter of a cast bullet can be adjusted by varying the alloy's antimony content.

The size and weight of bullets of a given alloy will also vary according to casting temperature. Higher temperatures will result in greater shrinkage as the bullet cools, thereby producing a slightly smaller and lighter bullet than one cast of the same alloy at a lower temperature.

## Gas Checks

SAECO has adopted the tapered form of gas check heel to minimize problems encountered with the use of various alloys and gas checks. SAECO bullets are designed to properly maintain the gas checks when cast with Lawrence Magnum Bullet Metal or linotype. Alloys producing smaller diameters may result in gas checks not seating properly. Bullet weights listed for gas check designs include the gas check weight.

## Bevel Base Bullets

SAECO Bevel Base bullets have a slight bevel at the base of the bullet. This bevel helps guide the bullet into the cartridge case. A benefit of using bevel base bullets is that the case will require minimal bell-mouthing, and have a longer case life. Bevel base bullets are of course easier to seat.

# Redding Shooting Caps



**Style "A"** - No. 99955 Low-profile, six panel heavy brushed twill cap. Fabric strap adjuster, antique brass buckle and grommet tuck-in, and matching under visor. Color: Camel/dark green  
**\$11.95 ea.**



**Style "B"** - No. 99965 Low-profile, six panel pigment-dyed canvas cap. Fabric strap adjuster with brass buckle and sewn slot. Color: Dark Green  
**\$10.95 ea.**



**Style "C"** - No. 99960 Low-profile, six panel heavy brushed twill cap. Plastic backstrap and matching under visor. Color: Dark Green  
**\$10.95 ea.**



**Style "D"** - No. 99950 Six panel, pro style shape cotton twill, TREEBARK™ camo, fused buckram front panels and plastic back strap.  
**\$13.95 ea.**



## EXTENDED SHELLHOLDERS

Extended shellholders are required when trimming short cases under 1 1/2" O.A.L. They are machined to the same tolerances as our standard shellholders except they're longer.  
 NO. 115XX (specify shellholder #) ..... **\$16.80**



## DEBURRING TOOL

Removes burrs and bevels case mouths for easy bullet seating. Hardened precision ground flutes make clean, easy, chatterfree cuts. Accepts all cases from .17 to .45 caliber.  
 NO. 09000 ..... **\$27.90**



## STUCK CASE REMOVAL KIT

Sooner or later everyone does it. Too little case lubricant (or using ordinary oil) and the case seizes in the resizing die. Usually, the rim pulls off and it is almost impossible to remove the stuck case without damaging the die. This case removal kit provides an easy solution to your problems. Instructions included.  
 NO. 22000 ..... **\$24.60**

## CASE PREPARATION KIT

All the tools you need in one package for removing dirt and powder residue from the inside of case necks and primer pockets. Kit comes complete with accessory handle, large and small primer pocket cleaners and three (3) case neck brushes to handle all cartridges from .22 thru .45 caliber.



NO. 18000 ..... **\$27.90**  
 NO. 18005 Accessory Handle ..... **7.80**  
 NO. 99139 Lg. Pocket Cleaner ..... **4.80**  
 NO. 99138 Sm. Pocket Cleaner ..... **4.80**  
 NO. 99137 Lg. Neck Brush ..... **3.90**  
 NO. 99136 Med. Neck Brush ..... **3.90**  
 NO. 99135 Sm. Neck Brush ..... **3.90**



## CASE LUBE KIT (PAD TYPE)

The most popular way to properly lubricate cases for resizing and case forming. The bottom side of the pad includes non-skid feet so it won't skate all over your bench when you are using it. Kit includes 2 oz. plastic bottle of Redding Case Lube.

Redding Case Lube Kit NO. 12012 ... **\$19.50**

Case Lube Pad only NO. 12010 ..... **\$13.80**

## WATER SOLUBLE CASE LUBE



Water soluble – but contains no water, therefore it is not harmful to your brass or dies. Can be used with all dies for normal resizing, but is ideal for neck sizing and use with straight wall pistol cases. Clean, neat and easy to clean up. 2 oz. plastic squeeze bottle.  
 NO. 21011 ..... **\$6.60**

## ORIGINAL FORMULA CASE LUBE



Packaged in 2 oz. plastic squeeze bottle. Formulated for tough resizing and forming operations. Prolongs the life of your dies and simplifies reforming. There is a difference in case lubes!  
 NO. 21000.... **\$6.60**



## BALL HANDLE CONVERSION

Convenient, easy-to-attach conversion for those who prefer a ball handle on their reloading press. Fits the Redding BOSS and other reloading presses that use a 5/8" handle diameter. Easily attaches without machining or threading.  
 NO. 99175 ..... **\$8.10**



### POWDER FUNNEL

Nearly indestructible, super-tough Lexan™. Fits most cartridge cases from .22 to .45 caliber. Anti-static prevents powder from sticking. NO. 13000 ..... **\$6.90**



**DIE SPACER KIT** For use with combination die sets and all 7/8-14 reloading dies to quickly compensate for case length or make a no-crimp adjustment without the need to move the lock rings. The kit includes three spacers: (.062) No-crimp or partial resizing, (.125) 44 Spl/44 Mag spacer, (.135) 38 Spl/357 Mag spacer. NO. 80901 ..... **\$10.80**

### HODGDON RELOADING MANUAL

The '07 Manual features loads for the top 50 rifle and pistol cartridges using Hodgdon, IMR & W-W powders plus shot-shell loads and articles by Layne Simpson, Charles Petty, Lane Pierce, Nick Sisley, Dick Metcalf and more. NO. 05988 ..... **\$7.99**



### BENCH STAND

For convenient bench-top mounting of Redding Powder Measures. Will also fit all other Powder Measures with 7/8-14 thread mounting. This bench stand is not threaded; it is secured with a lock ring which enables you to rotate the measure to any desired position and permits quick dump of the reservoir. NO. 06000 ..... **\$39.00**

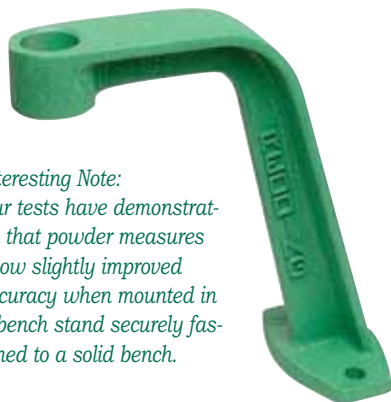

*Interesting Note:*  
Our tests have demonstrated that powder measures show slightly improved accuracy when mounted in a bench stand securely fastened to a solid bench.

### POWDER MEASURE RESERVOIRS

Replacement powder reservoirs are available in three sizes with or without caps. The smallest shown is the same as originally supplied on your Redding powder measure. The intermediate is 7-1/2" overall length and the largest available is 10". These fit all models of Redding powder measures using a 2-1/8" O.D. reservoir. NO. 99130 Original Replacement Reservoir...**\$7.80**  
NO. 99333 Original Replacement Reservoir with cap.... **\$10.20**  
NO. 99157 7-1/2" Reservoir.... **\$12.00**  
NO. 99165 7-1/2" Reservoir w/ cap.... **\$14.40**  
NO. 99162 Long 10" Reservoir.... **\$15.60**  
NO. 99167 Long 10" Reservoir with cap.... **\$18.00**



### DOUBLE "C" CLAMP

Now available in two sizes. The original SAECO Double "C" Clamp was designed as a convenient way to secure the SAECO lubrisizer to a bench top. The newest model is the ideal size for clamping the Redding powder measure stand and case trimmer to a bench top. Both units will accommodate a bench thickness of up to 2-1/4". May be used to mount any number of tools. Handy items for any reloading room. NO. 30120 Lubrisizer Clamp (2-3/8" inside fingers) .... **\$28.50**  
NO. 30520 Bench Stand/Trimmer Clamp (1-5/8" inside fingers) .... **\$28.50**  
*Note: NO. 30520 also fits Case Neck Gauge*



### INGOT MOULDS

The SAECO cast iron ingot mould will produce four easy-to-handle ingots. A perfect way to store blended alloys. NO. 23000...**\$24.60**



## Spare Parts

The spare parts listed represent only the most commonly requested service parts. For price and availability of items not listed, please consult factory.

### NO. RS-1 STANDARD POWDER SCALE

Pan ..... **7.80**  
Pan Hook ..... **4.50**  
Main Bearing\*\* ..... **6.00**  
Clean & recalibration\*\* ..... **12.00**

### NO. 2 MASTER POWDER SCALE

Pan ..... **7.80**  
Pan Hook Assembly ..... **8.70**  
Main Bearing\*\* ..... **6.00**  
Beam Assembly\*\* ..... **39.00**  
Clean & recalibration\*\* ..... **12.00**  
\*\*Scale must be returned to factory for replacement, cleaning and recalibration.

### NO. 3 & 3BR POWDER MEASURES

Drop Tube ..... **6.90**  
Lock Screw ..... **3.00**  
Universal Metering Chamber for 3BR Measure . . **60.00**  
Universal Metering Chamber for 3 Measure . . . . **43.50**  
Cap only ..... **3.60**  
Reservoir Screws (2) ..... **.90**  
BR-30 Operating Handle ..... **12.00**  
Powder Baffle ..... **6.90**

### NO. 1400 CASE TRIMMER

TiN Cutter (specify standard or 17 caliber) . **24.90**  
Shaft Only ..... **10.00**  
Collet ..... **18.00**  
Pilots (Solid Shank Style) ..... **4.80**

### PARTS FOR OLD STYLE TRIMMERS

(Models 13, 14, & 14K)  
Cutter Blade (Square or "V") specify ..... **6.00**  
Pilots (No. 15 Split Shank) ..... **6.00**

### ULTRAMAG & BOSS PRESS

Primer Arm Assembly ..... **16.50**  
Primer Pin (Lg. or Sm.) specify ..... **2.40**  
Primer Pin Sleeve (Lg. or Sm.) specify ..... **2.40**  
Primer Pin Spring ..... **1.20**  
Boss Primer Catcher ..... **7.80**

### T-7 TURRET PRESS & BIG BOSS

Turret, seven station w/bushing ..... **78.00**  
Primer Arm Assembly ..... **16.50**  
Primer Pin (Lg. or Sm.) specify ..... **2.40**  
Primer Pin Sleeve (Lg. or Sm.) specify ..... **2.40**  
Primer Pin Spring ..... **1.20**  
Big Boss Primer Catcher ..... **7.80**

### NO. 12 CASE LUBE PAD

Foam Pad Insert ..... **6.60**  
Adhesive Non-skid Feet (4) ..... **1.20**

### NO. 10 MISCELLANEOUS DIE PARTS

Die Spacer Rings- each ..... **3.90**  
Plastic Die Box ..... **6.60**  
Small Lock Rings ..... **1.80**  
Body Lock Ring 7/8"-14 ..... **3.60**  
Decap Pins (Pkg. of 5) ..... **2.40**

# Lifetime Warranty

All Redding Reloading Equipment has been carefully inspected prior to shipment and is fully warranted to be free from defects in materials and workmanship for life. Imperial and SAECO products now manufactured by Redding carry the same warranty.

Any product or parts which prove to be defective will be replaced or repaired without charge if returned prepaid to the factory.

Note: We reserve the right to decline responsibility where misuse or careless handling is evident or where repairs or modifications have been made or attempted by others.



All Redding products  
are proudly made  
in the U.S.A. with  
American Machinery



BULLET CASTING PRODUCTS

