

2007

BenelliUSA®

MASTER CATALOG



NEW 2007 DVD CATALOG

The new 2007 DVD catalog contains detailed information on the entire product line and all of the new products currently available from Benelli, Franchi, Uberti, Stoeger and Stoeger Books. This exciting DVD is over 60 minutes of action videos showcasing the Benelli USA products with interactive presentations, printable PDFs of all the 2007 catalogs, links to all of the Benelli websites and much more.

INTERACTIVE WEBSITE LINKS

benelliusa.com
 franchiusa.com
 uberti.com
 stoegerindustries.com
 stoegerbooks.com
 benellitv.com

Order your 2007 DVD catalog by calling 1-888-BENELLI, or visit freedvd.benelliusa.com

BenelliUSA®

Tel: 301.283.6981 Fax: 301.283.6988
 benelliusa.com

Design and production by Barron Marketing Communications - www.barronmarketing.com



Benelli **Franchi** **A. Uberti**
Stoeger **StoegerBooks**

CONTENTS

Benelli

2	Introduction	20	Left-Hand Models
3	Inertia Driven®	22	SuperNova
4	ComforTech™ System	24	Nova Pump
7	Crio® System	26	Slug Gun Models
8	Super Black Eagle II	28	Turkey Gun Models
10	M2 Field	30	Defense
12	Cordoba	34	R1 Rifle
14	SuperSport and Sport II	36	Parts and Accessories
16	Legacy	41	Benelli Gear
18	Ultra Light	46	Specifications
19	Montefeltro and Montefeltro Silver	50	Tom Knapp and Tim Bradley



Franchi

54	Introduction	62	Renaissance Sporting
55	Inertia Driven®	64	Renaissance
56	I-12	66	Parts and Accessories
58	712 and 720 Competition	67	Franchi Gear
60	48 AL	70	Specifications
61	720		



A. Uberti

74	Introduction	89	Top Break
76	Walker	90	Rolling Block
77	Dragoon and Pocket Revolvers	91	1860 Henry
78	Army and Navy	92	1866 Yellowboy
79	New Army, Pocket Navy, Target Carbine and Police	93	1873 Rifle and Carbine
80	Conversion and Open Top	94	1874 Sharps
82	Single Action Cattleman	96	Lightning
86	Cattleman Bird's Head and Bisley	97	Springfield Trapdoor
87	Revolver Carbine and Buntline	98	1885 High-Wall Single-Shot Rifles
88	Outlaw, Frontier and Police	99	Knives and Sights
		100	Specifications



Stoeger

110	Introduction	120	Condor Outback
110	Inertia Driven®	122	Uplander
112	Model 2000	124	Coach Gun
114	Model P-350	126	Cougar
116	Condor Competition & Combo	128	Specifications
118	Condor	130	Stoeger Books



WORLD CLASS COLLECTORS

138	Introduction	144	Franchi World Class
140	Benelli World Class	145	Uberti World Class
		146	Specifications





Benelli[®]
simply perfect

- 8 SUPER BLACK EAGLE II
- 10 M2 FIELD
- 12 CORDOBA
- 14 SUPER SPORT & SPORT II
- 16 LEGACY
- 18 ULTRA LIGHT
- 19 MONTEFELTRO
- 20 LEFT-HAND MODELS
- 22 SUPERNOVA
- 24 NOVA PUMP
- 26 SLUG GUNS
- 28 TURKEY GUNS
- 30 DEFENSE
- 34 R1 RIFLE

BENELLI

Benelli® offers the largest selection of semi-automatic shotguns in the world; no other company even comes close. There are more than 120 different models to choose from. Benelli offers dozens of different waterfowl models, but there's a whole lot more. There are turkey guns, youth guns and youth turkey guns. You'll find the perfect pheasant gun, a feather-light 20-gauge for quail, woodcock and grouse. There are target guns, tactical guns and a combat shotgun for the Marine Corps. Benelli shotguns come with fancy walnut, synthetic and camo stocks, Crio® Chokes, ported, cantilevered and rifled barrels. There are even more than a dozen left-handed models. Benelli's innovations in design, technology and manufacturing are cutting edge and always will be, because with a Benelli, you can expect every feature you need and none that you don't.

No matter your sport, Benelli's got your gun.



NEW MONTEFELTRO SILVER — 12 AND 20-GA, 3"

INERTIA DRIVEN® SYSTEM

INERTIA DRIVEN® is the best operating system ever devised — Period!

- **SIMPLE** — Inertia Driven® is simple with only three primary parts: the bolt body, the inertia spring and the rotating bolt head. Simple is better.
- **FASTER** — With a greatly reduced mass of parts Inertia Driven® is faster.
- **CLEANER** — Gas, smoke and burnt powder stay in the barrel where they belong, rather than being channeled into the gun's mechanism as they are in gas systems.
- **STRONG** — The massive steel locking lugs on the Inertia Driven® system's rotating bolt head not only lock steel-to-steel into the gun's barrel; the lugs are locked-in tighter during firing as well.
- **LOW MAINTENANCE** — The Inertia Driven® system is much cleaner so gun cleanup takes a fraction of the time that it takes to clean a gas system gun.

- **LIGHT WEIGHT** — The Inertia Driven® system is not only incredibly simple; it is also lightweight, allowing Benelli shotguns to be some of the lightest semi-automatic shotguns ever produced.
- **PERFECT BALANCE** — With no springs, action bar linkage or heavy gas cylinder under the fore-end, Benelli's Inertia Driven® shotguns balance like a fine game gun should.
- **RELIABLE** — The Inertia Driven® system never needs adjusting and will cycle anything from field loads to 3½" magnums with consistent reliability, year, after year, after year. In fact, there are Inertia Driven® Benelli shotguns that have fired over 500,000 rounds, still in the field and functioning perfectly.

EXPLODED VIEW

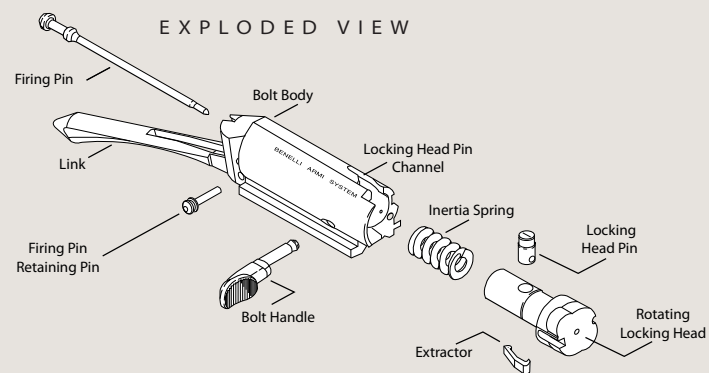

"THE LAW OF INERTIA" — is Newton's First Law of Physics and is as consistent and unchangeable as The Law of Gravity. Benelli has harnessed this basic law of physics in the Inertia Driven® system to operate the World's fastest, simplest and most reliable semi-automatic shotguns. It's not boasting, it's the law — The Law of Inertia.



BENELLI'S INERTIA DRIVEN® SYSTEM



Cartridge drop lever (Works three ways)

- 1 Pulling back on the operating bolt handle and pressing the cartridge drop lever locks the bolt to the rear.
- 2 With bolt forward, pressing it releases a shell onto the carrier.
- 3 Visibility of the red dot indicates the hammer is cocked.

STEP ONE: CHAMBERING

As the bolt assembly moves into battery, the locking head pin moves along a curved track in the bolt body to rotate the steel bolt head into engagement with the steel barrel extension. The cartridge drop lever is down, the red dot indicating that the gun is cocked.



STEP TWO: FIRING

When the trigger is pulled, every part of the shotgun except the bolt body moves rearward. The curved track in the bolt body, which is moving forward relative to the rest of the gun, presses against the locking head pin, turning the bolt head even tighter into the barrel extension. At the same time, the inertia spring is compressed between bolt head and body. The cartridge drop lever moves up, allowing a shell to move from the magazine to the carrier.



STEP THREE: RECOIL

Near the end of the recoil cycle, chamber pressure drops to a safe level and the gun's rearward motion slows. The heavy inertia spring then thrusts the bolt assembly rearward, unlocking the rotating bolt head, extracting the spent shell from the chamber and pulling it against the ejector.



STEP FOUR: EJECTION

As the empty shell exits the receiver, the energy of the moving bolt assembly recocks the hammer and compresses the recoil spring in the buttstock. The recoil spring then thrusts the bolt assembly forward, lifting the on-coming shell into position and chambering a fresh cartridge. The gun is ready to fire again in a fraction of a second!

BENELLI'S INERTIA DRIVEN® BOLT

Comes standard with all Benelli semi-auto shotguns. With the Inertia Driven® system, fouling and gases are expelled out the barrel, not into the operating system. Because there are no complicated linkages or o-rings to malfunction and without heavy weights and pistons in the fore-end, gun balance and swing are superior with a Benelli.





NEWTON'S THIRD LAW –
"For every action there is
an equal and opposite reaction."

Constructed from a shock absorbing synthetic material developed for the medical industry, the ComforTech™ recoil pad is ergonomically designed to fit the shooter's shoulder pocket. Consequently, the ComforTech™ gel recoil pad spreads energy over a wider area than conventional buttpads to greatly reduce felt recoil.

Benelli engineers developed specialized machinery to accurately measure and graph recoil.

COMFORTECH™ SYSTEM



Benelli's ComforTech™ system revolutionizes firearms technology. For centuries, the laws of physics have defined shooting comfort. If you wanted less recoil, your choices were to make the shot charge lighter or the gun heavier. One limited on-target effectiveness, the other the speed and liveliness of the shotgun.

You can't repeal the laws of physics, but sometimes you can fool Mother Nature. Benelli reached outside the firearms industry to materials scientists, computer specialists and design engineers to take a fresh look at recoil and how to tame it. The result? A new stock system that reduces felt recoil by as much as 48% over the competition!

It's often said there's nothing new in guns, but the ComforTech™ system is unlike anything ever seen before. Previous generations of firearms designers never had access to the computer modeling, high-speed photography and state-of-the-art synthetics that make this revolution in shooting comfort possible.

How the competition stacks up against the ComforTech™ system:

- **WEIGHT COMPARISON** – the competition weighs 13% to 15% more (on average – that is a pound or more!)
- **RECOIL COMPARISON** – the competition kicks up to 48% harder.
- **MUZZLE CLIMB COMPARISON** – the competition recovers as much as 69% slower. To put it simply, Benelli engineers have created the lightest, softest kicking shotgun on earth. It gets back on target faster than any other and don't forget, Benelli is already the fastest cycling auto-loading shotgun in the world!

At Benelli, we can't break the laws of physics, but we can bend them just a little.

AirTouch™ dimpled checkering design provides secure wet/dry grip.



Benelli includes a set of shims to make customizing the gun's drop and cast a snap.



Synthetic Recoil-Absorbing Chevrons

To test durability the stock was subjected to 100,000 brutal cycles with the recoil pad removed in a fixture exerting 20% more force than the most powerful 3½" magnum loads available. Testing was conducted at temperature extremes ranging from 150° F to -75° F. In the end the ComforTech™ stock looked and performed as well as it did when new!

COMFORTECH™ STOCK

THE COMFORTECH™ STOCK is split diagonally from the heel of the buttstock to a point just behind the pistol grip. Connecting the two pieces are eleven synthetic recoil-absorbing chevrons that form a highly effective recoil barrier.

COMPUTER SIMULATION showed Benelli engineers the path of recoil (blue areas are minimum stress) through a gun stock. The ComforTech™ stock was computer designed so even the exterior shell flexes to dampen recoil.

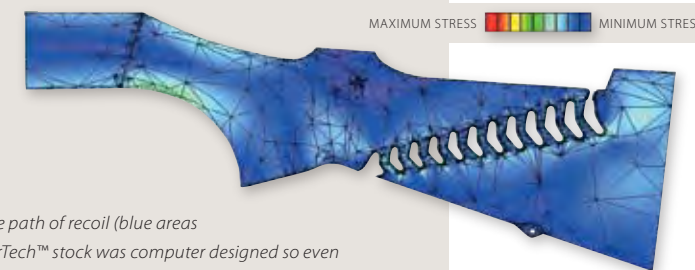

COMFORTECH™ RECOIL MEASUREMENTS

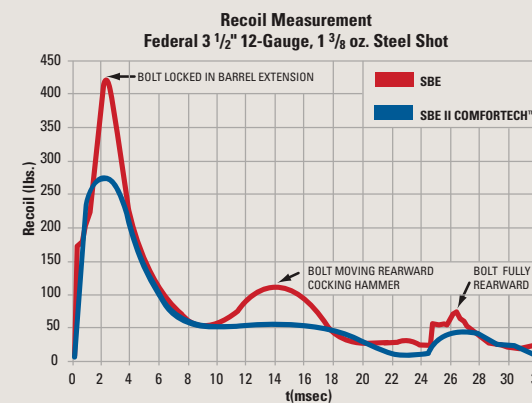

Benelli engineers developed specialized machinery to measure and graph recoil. Here a Benelli Super Black Eagle is plotted along with an SBE II with ComforTech™. A dramatic reduction with ComforTech™ can be seen in all three peaks of recoil — firing, bolt cocking the hammer and the end of bolt travel.

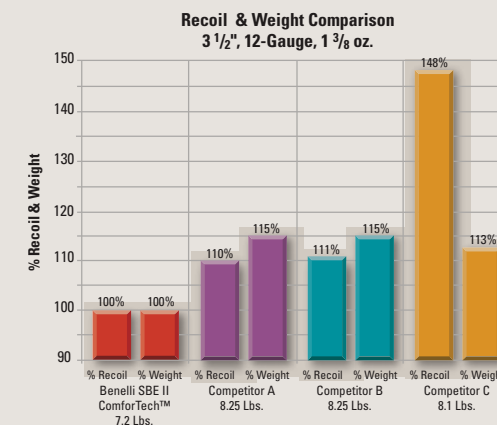

The Super Black Eagle II does what many thought was impossible; it is both the lightest gun in its class and the softest-kicking. Imagine how fresh you'll be at the end of a long hunting day with that combination!



COMFORTECH™ GEL RECOIL PADS & COMB INSERTS

Optional ComforTech™ gel recoil pad inserts, to customize and adjust the length-of-pull to the shooter. And, ComforTech™ comb inserts to adjust the drop-of-comb, for better target acquisition (Not available for wood gun stocks).



COMFORTECH™ SYSTEM

COMFORTECH™ SYSTEM REDUCES MUZZLE CLIMB

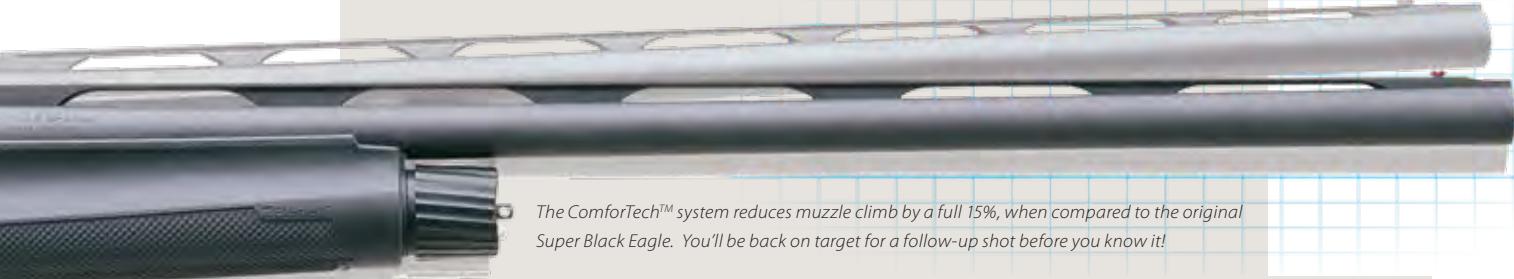

The ComforTech™ system reduces muzzle climb by a full 15%, when compared to the original Super Black Eagle. You'll be back on target for a follow-up shot before you know it!

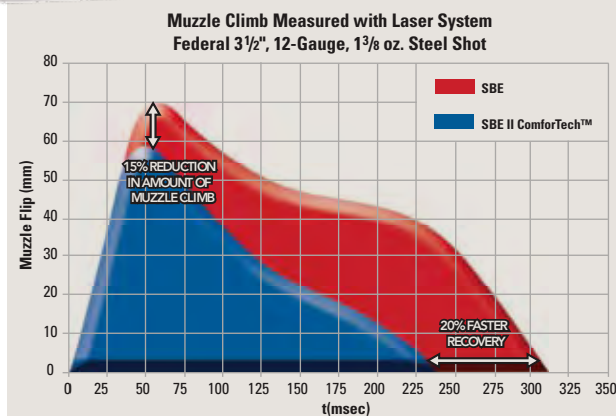

Forget about losing sight of a fleeing flock. You'll get 15% less muzzle climb and 20% faster recovery with the Super Black Eagle II. Bagging doubles will become the rule, not the exception.

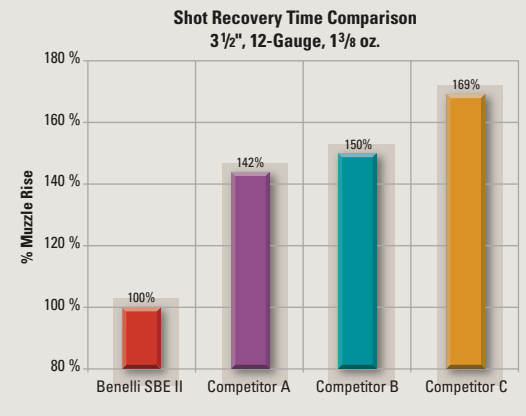

They'll wonder how you do it. You'll know the reason is that your recovery time is as much as 69% faster than competitive shotguns. You'll bag birds while they're still trying to get back on target.

COMFORTECH™ GEL RECOIL PADS



OLD STYLE



LEFT RECOIL PAD

RIGHT RECOIL PAD

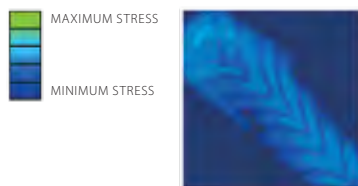

GEL RECOIL PADS



COMPARISON CHART

The gel recoil pad puts more shock-absorbing material against your shoulder to spread recoil. There are no hard inner structures to jab against you. It's like having a pillow against your shoulder rather than a board.

GEL RECOIL PADS

COMFORTECH™ GEL RECOIL PADS: The ergonomics of the gel recoil pad are so carefully engineered that there are separate versions for left- and right-handed shooters. The pad is shaped to conform to the contours of the shoulder for maximum contact.



CRIO® SYSTEM

Cryogenic physics has revealed that strange things happen when matter is taken to temperatures of -300° F; gases become liquids and solids, ceramics become conductors of electricity and steel is changed at the molecular level.

When a Benelli barrel is cryogenically frozen, all of the stresses caused by hammer forging are relieved and the surface of the bore takes on a more even-grained, slicker surface that offers less resistance to wads and shot charges. With a smoother and more uniform surface, Benelli Crio® Barrels not only pattern better, they stay cleaner longer.

Crio® Chokes are the second part of the Benelli Crio® System. Extra long choke tubes, with a more gradual constriction, coupled with the slick surface created by the cryogenic treatment, puts more pellets on target. The Benelli Crio® System improves patterns by as much as 13.2% and yields denser, more uniform shot patterns.

The Crio® System combines a barrel frozen to -300° F with a specially designed longer choke tube that is also cryogenically treated. The result is a denser, more uniform pattern with up to 13.2% more pellets on target.



BENELLI'S CRIO® SYSTEM TECHNOLOGY

Cryogenically Treated

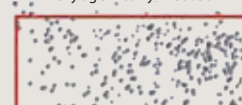

BETTER SHOT PATTERN

With high speed cameras Benelli engineers caught shot strings in flight. Crio® Barrels and chokes threw patterns with substantially denser and more uniform shot patterns than common shotgun barrels.

Untreated

Cryogenically Treated



WHY FREEZE A BARREL?

Hammer-forging induces stresses in the barrel steel caused by an uneven grain structure (left). Freezing the barrel to -300° F changes the steel at the molecular level, leaving a more even grain structure. The result? The barrel flexes more predictably and has a smoother bore surface that resists fouling.

CRIO® CHOKE SYSTEM

The specially designed longer choke tubes of the Crio® Choke System allows for more gradual constriction of the shot charge, which reduces pellet deformation. Frozen to -300° F, Crio® Chokes have a more evenly grained and slicker surface that provides less resistance to the shot charge as it passes through.

When coupled with a Crio® Barrel, the result is as much as 13.2% more pellets on target.

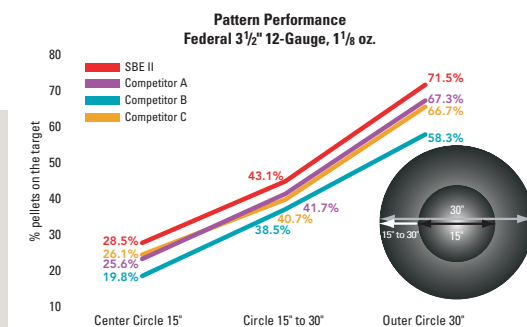

When compared to the competition, the new Crio® Barrel puts 13.2% more pellets in a 30" circle. That's bird-busting power you'll see in the field! This sort of pattern performance once required special barrels and aftermarket choke tubes. With the Super Black Eagle II, you get it right out of the box!

SUPER BLACK EAGLE II

The Super Black Eagle II sets the standard for styling, versatility and performance by which all other semi-auto shotguns are judged. That judgment is based on unfailing reliability—the kind of reliability that you can count on, shot, after shot, after shot. As the original 3½" semiauto shotgun, the Super Black Eagle was on the cutting edge of shotgun development, and was followed by the newly-designed Super Black Eagle II featuring the innovative recoil-reducing ComforTech™ stock. The Super Black Eagle II uses the proven Benelli Inertia Driven® bolt mechanism that allows the Super Black Eagle II to shoot 2¾", 3" and even 3½" magnum ammunition without adjustments. In addition, the Super Black Eagle II incorporates some basic improvements, such as a drilled and tapped receiver.

The new ComforTech™ system reduces recoil up to 48% over the competition, without adding any moving parts or weight. Compared to competing brands, the Benelli weighs 13 to 15% less — on average, that's more than a pound less! The ComforTech™ system also reduces muzzle climb by 15%. for fast follow-up shots. This allows shooters to get back on target up to 69% faster than the competition.

The buttpad, made of a shock-absorbing gel originally developed for the medical industry, works with the ComforTech™ system to soak up recoil. Benelli engineers created an ergonomic design so refined that left- and right-handers have entirely different recoil pads. A corrosion-resistant recoil spring and guide remain free of rust and ride in a recoil tube that is easily cleaned by removing the quick-detachable recoil pad.

Benelli includes a set of shims to make customizing the gun's drop and cast a snap.



SUPER BLACK EAGLE II, COMFORTECH™ — 12-GA, 3½" MSRP \$1,635
Advantage® Max-4 HD™

SUPER BLACK EAGLE II — 12 GAUGE



SUPER BLACK EAGLE II, COMFORTECH™ — 12-GA, 3½" MSRP \$1,665
Advantage® Timber HD™

SUPER BLACK EAGLE II, COMFORTECH™ — 12-GA, 3½" MSRP \$1,665
Advantage® Max-4 HD™

NEW SUPER BLACK EAGLE II, COMFORTECH™ — 12-GA, 3½" MSRP \$1,665
Realtree® APG HD™

SUPER BLACK EAGLE II, COMFORTECH™ — 12-GA, 3½" MSRP \$1,545
Black synthetic

SUPER BLACK EAGLE II, NON-COMFORTECH™ — 12-GA, 3½" MSRP \$1,480
Satin walnut

See Super Black Eagle II Slug models on page 27.

This special synthetic gel comb insert not only cushions the shooter's cheek during recoil, it also has a slippery surface that allows the cheek to slide along the surface for added comfort. Available in 3 comb sizes, ComforTech™ stocks only.



The trigger guard has 30% more room, so even in the coldest waterfowling weather, the heaviest gloved finger will fit easily.



The SBE II's magazine cap has heavier ribs so that take down is easier, even with gloved hands.

Adjustable length-of-pull with optional ComforTech™ gel recoil pad.



FEATURES

STANDARD FEATURES

CHOKE TUBES: Crio® C, IC, M, IM, F and wrench.
FINISHES: Realtree® APG HD™, Advantage® Max-4 HD™, Advantage® Timber HD™, Black synthetic or Satin walnut.
GEL PADS: ComforTech™ gel recoil and comb pads (ComforTech™ models only).
SHIM KIT: For adjustment of drop and cast.

OPTIONAL FEATURES

CHOKE TUBES: Extended chokes for pass shooting, over the decoys waterfowl shooting and extra-full turkey.
GEL RECOIL PADS: Three options to customize length-of-pull to 13½", 14" or 14½".
RAISED COMB PADS: Three options to customize sight plane for different shooting scenarios from target shooting to scoped hunting.



Extra-high Comb

Raised Comb

Standard Comb



AirTouch™

A dimpled grip checkering pattern called AirTouch™ gives the shooter a firm grasp on the pistol grip and fore-end, hot or cold, wet or dry.



INERTIA DRIVEN

ComforTech™

M2 FIELD



NEW M2 FIELD, COMFORTECH™ — 20-GA, 3" MSRP \$1,335
Realtree® APG HD™

The M2 Field is the workhorse of the Benelli semi-auto line. Light, nimble, but ruggedly built, the Benelli M2 is built around the ultra-reliable Inertia Driven® bolt mechanism. The Inertia Driven® system allows the M2 to digest nearly any 12-gauge cartridge, from 2¾" target loads to the heaviest 3" magnums.

Benelli engineers have also adapted the ComforTech™ recoil system for the M2. This revolutionary system reduces felt recoil by up to 48%, and cuts muzzle climb by 15%. When combined, this puts the shooter back on target up to 69% faster than with any other comparable semi-automatic shotgun. The M2 is not only faster, but with the new ComforTech™ system, it may be the most comfortable shotgun you will ever shoot.

The M2 is a workhorse with the speed of a thoroughbred.



Benelli includes a set of shims to make customizing the gun's drop and cast a snap.

M2 FIELD — 12 GAUGE



NEW M2 FIELD, COMFORTECH™ — 12-GA, 3" MSRP \$1,335
Realtree® APG HD™



M2 FIELD, COMFORTECH™ — 12-GA, 3" MSRP \$1,335
Advantage® Max-4 HD™



M2 FIELD, COMFORTECH™ — 12-GA, 3" MSRP \$1,335
Advantage® Timber HD™



M2 FIELD, COMFORTECH™ — 12-GA, 3" MSRP \$1,215
Black synthetic



M2 FIELD, NON-COMFORTECH™ — 12-GA, 3" MSRP \$1,145
Satin walnut

M2 FIELD — 20 GAUGE

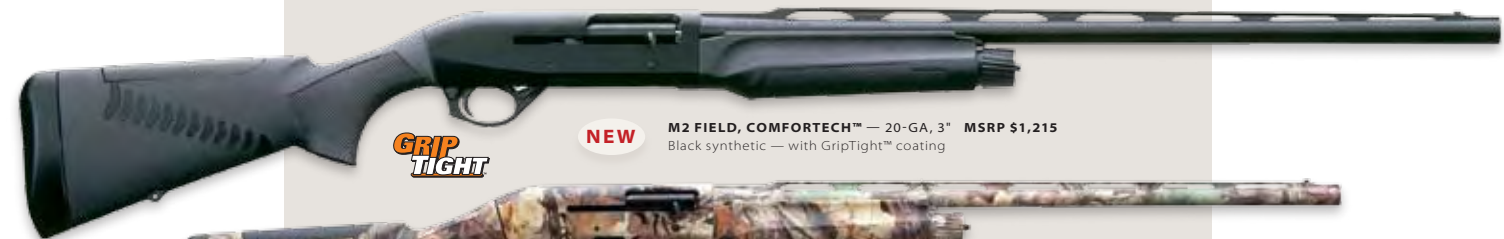

NEW M2 FIELD, COMFORTECH™ — 20-GA, 3" MSRP \$1,215
Black synthetic — with GripTight™ coating

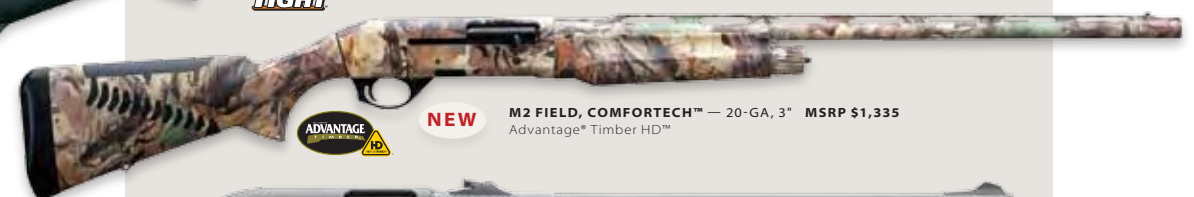

NEW M2 FIELD, COMFORTECH™ — 20-GA, 3" MSRP \$1,335
Advantage® Timber HD™



NEW M2 FIELD RIFLED SLUG, COMFORTECH™ — 20-GA, 3" MSRP \$1,280
Black synthetic — with GripTight™



Benelli's M2 trigger guard and safety are a blend of style and function that comes together on the Benelli M2.



The M2's magazine cap has heavier ribs so that take down is easier, even with gloved hands.



The AirTouch™ dimple checking pattern on the M2's pistol grip and fore-end gives a secure grip, in any kind of weather.

AirTouch™

Adjustable length-of-pull with optional ComforTech™ gel recoil pad. (Not available for wood gun stocks).



Optional Short Pad 13½" L.O.P.
Optional Medium Pad 14" L.O.P.
Standard Pad 14¾" L.O.P.

FEATURES

STANDARD FEATURES

- CHOKE TUBES:** Crio® C, IC, M, IM, F and wrench.
- FINISHES:** Realtree® APG HD™, Advantage® Max-4 HD™, Advantage® Timber HD™, Black synthetic or Satin walnut.
- GEL PADS:** ComforTech™ Gel recoil and comb pads (ComforTech™ models only).
- SHIM KIT:** For adjustment of drop and cast.
- HARD CASE:** Custom fitted hard case to protect in transport.

OPTIONAL FEATURES

- CHOKE TUBES:** Extended chokes for pass shooting, over the decoys waterfowl shooting and extra-full turkey (12-gauge only).
- GEL RECOIL PADS:** Three options to customize length-of-pull to 13½", 14" or 14¾".
- RAISED COMB PADS:** Three options to customize sight plane for different shooting scenarios from target shooting to scoped hunting.

The corrosion-resistant recoil tube and stainless steel spring can be accessed easily by removing the quick-detachable recoil pad.



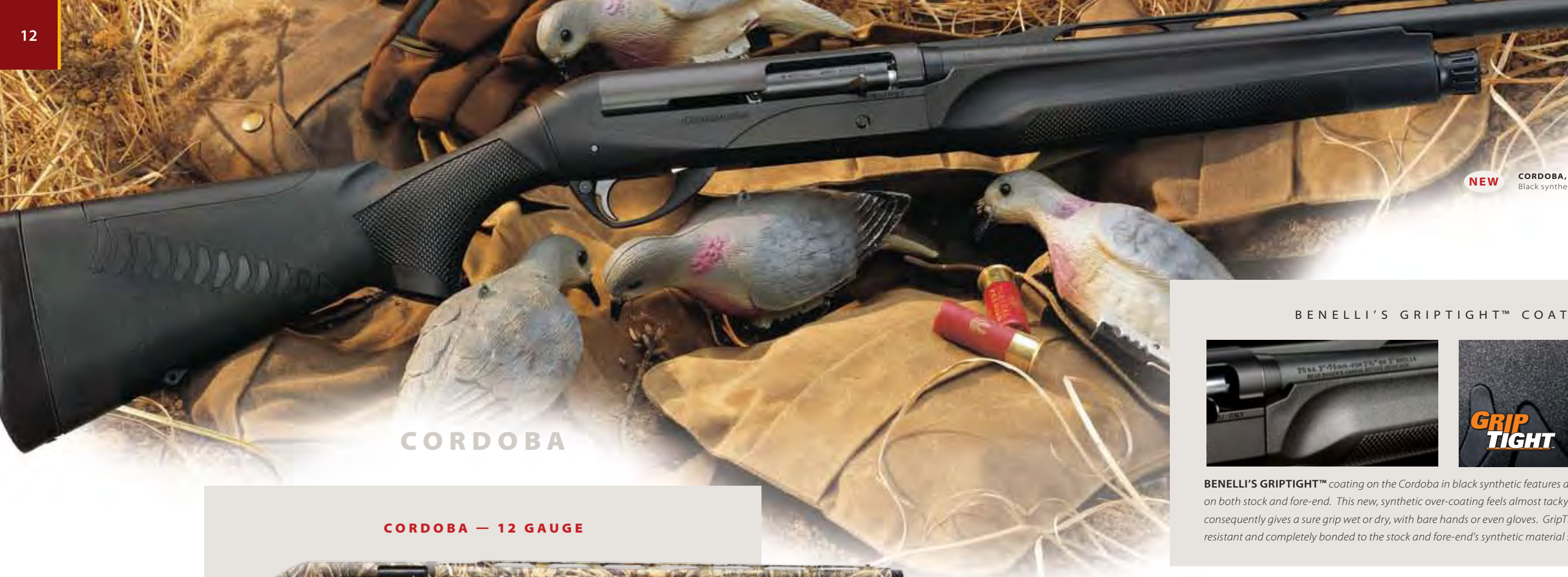

CORDOBA

NEW CORDOBA, COMFORTECH™ — 20-GA, 3" MSRP \$1,735
Black synthetic — with GripTight™ coating

BENELLI'S GRIPTIGHT™ COATING

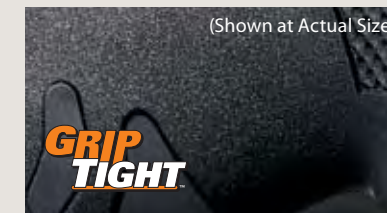

BENELLI'S GRIPTIGHT™ coating on the Cordoba in black synthetic features a high-tech texturing on both stock and fore-end. This new, synthetic over-coating feels almost tacky to the touch, and consequently gives a sure grip wet or dry, with bare hands or even gloves. GripTight™ is totally weather resistant and completely bonded to the stock and fore-end's synthetic material surface.

CORDOBA — 12 GAUGE



NEW CORDOBA, COMFORTECH™ — 12-GA, 3" MSRP \$1,865
Advantage® Max-4 HD™
(Shown with optional raised comb pad insert)



CORDOBA, COMFORTECH™ — 12-GA, 3" MSRP \$1,735
Black synthetic — with GripTight™ coating

CORDOBA — 20 GAUGE

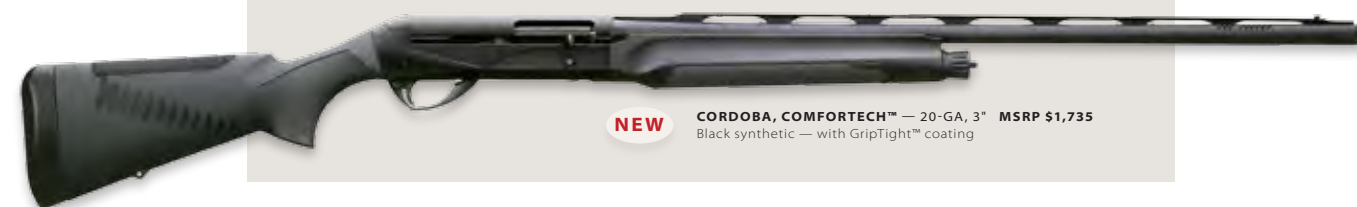

NEW CORDOBA, COMFORTECH™ — 20-GA, 3" MSRP \$1,735
Black synthetic — with GripTight™ coating

Inspired by the high volume dove shooting found around Cordoba, Argentina, Benelli engineers designed the Cordoba as a lightning fast hunting gun with all the advanced features of a serious sporting clays shotgun. Incorporated into the new Cordoba is the 10-mm tapered sporting rib favored by competition shooters and porting to keep barrel climb to a minimum. The ComforTech™ stock cushions the blow when ammo isn't measured in boxes, but by cases in an afternoon. The ComforTech™ system also helps reduce barrel climb and puts the shooter back on target 69% faster, so that the new Cordoba just may be the fastest field gun ever built. A Crio® barrel and extended Crio® choke tubes put more pellets on target and the whole package is finished in matte black GripTight™ coating or Advantage® Max-4 HD™, so a reflected flash won't give you away.



SHELLVIEW™

WARNING!
Always physically and visually check the magazine tube and chamber to verify that the firearm is not loaded!



ShellView™, available with the 20-gauge Cordoba, allows the shooter to visually check the number of shells in the magazine tube at a glance.

Extended Crio® Chokes reduce pellet deformation for better clay busting performance. The ported barrel combined with the ComforTech™ system nearly eliminates muzzle climb allowing for fast second target acquisition. A high-visibility red bar sight and 10- to 8-mm tapered stepped rib, provides fast and consistent sight alignment.

Extended Crio® Choke tubes are standard. All models are available in 28" and 30" barrels.

FEATURES

STANDARD FEATURES

- CHOKE TUBES:** Extended Crio® C, IC, M, IM, F and wrench.
- FINISHES:** Advantage® Max-4 HD™, GripTight™ over Black synthetic.
- BARRELS:** Crio® treated barrel.
- GEL PADS:** ComforTech™ Gel recoil and comb pads.
- SHIM KIT:** For adjustment of drop and cast.

OPTIONAL FEATURES

- CHOKE TUBES:** Extended chokes for pass shooting, over the decoys waterfowl shooting and extra-full turkey (12-gauge only).
- GEL RECOIL PADS:** Three options to customize length-of-pull to 13½", 14" or 14¾".
- RAISED COMB PADS:** Three options to customize sight plane for target shooting.



NEW SUPERSPORT, COMFORTECH™ — 20-GA, 3" MSRP \$1,800
Carbon Fiber finish — with ShellView™



Ported Crio® Barrel

SUPERSPORT & SPORT II

The Benelli SuperSport and Sport II are the ultimate “speed guns” for sporting clays. The SuperSport’s ComforTech™ recoil-dampening system allows the shooter to recover for the critical second shot up to 69% faster than with other comparable shotguns — that’s fast! Couple the quick recovery speed with a ported barrel that keeps muzzle climb to a minimum and it’s doubly fast. And the ComforTech™ system’s special gel recoil pad and comb insert reduce felt recoil by up to 48% compared to the competition.

For traditionalists, the Sport II’s stock features beautifully figured A-Grade walnut with a satin luster finish, a right-hand contour gel recoil pad, and cut-checkering on both pistol grip and fore-end. When one clay often separates the winners from the losers, the SuperSport and Sport II’s superior reliability, faster recovery time, lower recoil and denser shot patterns is almost like having an unfair advantage.

SPORT II



NEW SPORT II — 20-GA, 3" MSRP \$1,580
A-Grade satin walnut

SPORT II, — 12-GA, 3" MSRP \$1,580
A-Grade satin walnut

SUPERSPORT



SUPERSPORT, COMFORTECH™ — 12-GA, 3" MSRP \$1,800
Carbon Fiber finish
(Shown with optional raised comb pad insert)

SHELLVIEW™

WARNING!
Always physically and visually check the magazine tube and chamber to verify that the firearm is not loaded!



Magazine Tube Benelli's ShellView™ in Fore-end Rounds still in magazine Empty

Benelli includes a set of shims to make customizing the gun's drop and cast a snap.

ShellView™ available with the 20-gauge Cordoba, allows the shooter to visually check the number of shells in the magazine tube at a glance.

They'll wonder how you do it. You'll know the reason is that your recovery time is as much as 69% faster than competitive shotguns. You'll bag birds while they're still trying to get back on target.

Shot Recovery Time Comparison
3 1/2", 12-Gauge, 1 3/8 oz.

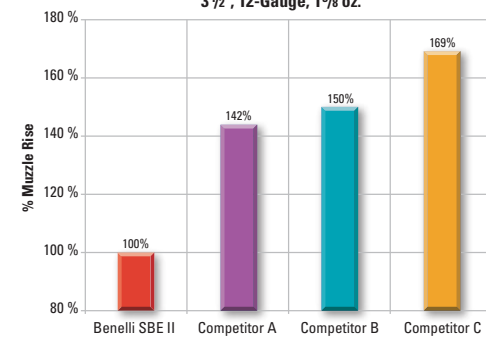

Extended Crio® Choke tubes are standard. All models are available in 28" and 30" barrels.

FEATURES

SUPERSPORT STANDARD FEATURES

- CHOKE TUBES:** Extended Crio® C, IC, M, IM, F and wrench.
- FINISH:** Carbon Fiber finish.
- BARRELS:** Crio® treated ported barrel.
- GEL PADS:** ComforTech™ Gel recoil and comb pads.
- SHIM KIT:** For adjustment of drop and cast.
- HARD CASE:** Custom fitted hard case to protect in transport.

SPORT II STANDARD FEATURES

- CHOKE TUBES:** Extended Crio® C, IC, M, IM, F and wrench.
- FINISH:** A-Grade satin walnut.
- BARRELS:** Crio® treated ported barrel.
- GEL PADS:** Gel recoil pad.
- SHIM KIT:** For adjustment of drop and cast.
- HARD CASE:** Custom fitted hard case to protect in transport.



The trigger assembly is easily removed as a unit by driving out just one pin.





LEGACY — 20-GA, 3" MSRP \$1,565
AA-Grade satin walnut

LEGACY

If you appreciate style and performance along with the finer things that life has to offer, it's for you that Benelli created the Legacy. Blending distinctive style and performance, the Legacy is built around the ultra-reliable Inertia Driven® system, with all the refinements and attention to detail that discriminating shooters expect. The sculptured lower receiver, with classic game scene etchings, is contrasted by a highly polished and blued upper receiver to give the Legacy uncompromising eye-catching originality. Complimenting the sculptured metal, the Legacy is stocked with hand-select AA-Grade, satin walnut. A shim kit allows you to custom fit your own special Legacy stock dimensions because style is important, but function is mandatory. The Legacy is an elegant, smooth-swinging gun that combines the best in materials and workmanship with the most modern engineering.



Benelli includes a set of shims to make customizing the gun's drop and cast a snap.



The Legacy's handsome AA-Grade walnut stock is deeply checked to give you a sure grip out in the field.



The beautifully engraved receivers, with the deep patina, make the Legacy the hunters choice when looking for that old world craftsmanship.

The durable protective carrying case protects your Benelli shotguns with style and safety during trips to the range or field.



LEGACY

LEGACY — 20-GA, 3" MSRP \$1,565
AA-Grade satin walnut

LEGACY — 12-GA, 3" MSRP \$1,565
AA-Grade satin walnut

LEGACY SIDEPLATE DETAILS



LEGACY — 20-GA.
Pair of dove & upland quail



LEGACY — 12-GA.
Drake & hen mallard and two ringneck pheasants



The trigger assembly is easily removed as a unit by driving out just one pin.

FEATURES

STANDARD FEATURES

- CHOKE TUBES:** C, IC, M, IM, F and wrench.
- FINISH:** AA-Grade satin walnut.
- SIDE PLATE:** Acid etched game scenes with rich patina.
- SHIM KIT:** For adjustment of drop and cast.
- HARD CASE:** Custom fitted hard case to protect in transport.

OPTIONAL FEATURES

- CHOKE TUBES:** Extended chrome C, IC, M, IM, F.
- STOCK:** AAA-Grade stock and fore-end.
- BARRELS:** Variety of lengths of high-luster blued barrels.





NEW **ULTRA LIGHT** — 12-GA, 3" MSRP \$1,385
Satin walnut / WeatherCoat™

ULTRA LIGHT

Weighing only 6 lbs., the Ultra Light is the lightest 12-gauge semi-automatic shotgun ever produced. The Ultra Light sports a featherweight alloy receiver, shortened magazine tube and a unique raised target rib made from the same super light, super strong carbon fiber employed in Formula 1 racecars. However, this Benelli is no lightweight when it comes to standing up to punishment.



No matter if you're in those long pheasant fields in South Dakota or after scaled quail running through the cactus in West Texas, if your average hunting day is measured in miles, check out the new 6 lb. Ultra Light at your Benelli dealer. For more information go to BenelliUSA.com.

The Ultra Light's stock and fore-end are sealed with a five-step process called WeatherCoat™. This coating makes them virtually impervious to any kind of weather and, as a bonus, this special stock finishing process also enhances the fancy figure of the wood.



ULTRA LIGHT FORE-END COMPARISON



MONTEFELTRO FORE-END



ULTRA LIGHT FORE-END

The Ultra Light's magazine tube and fore-end are considerably shorter than the Montefeltro's. This new design makes the Ultra Light incredibly light on those long hunts.



The Ultra Light magazine cap is stylishly designed and grooved for a positive grip for removing or installing.



The light-weight carbon fiber rib has a high-visibility red bar sight with a mid-bead and stepped rib which provides fast and consistent sight alignment.



The carbon fiber rib is complemented by a matching carbon fiber grip cap.

MONTEFELTRO



MONTEFELTRO

MONTEFELTRO — 12-GA, 3" MSRP \$1,110
Satin walnut

MONTEFELTRO — 20-GA, 3" MSRP \$1,110
Satin walnut

MONTEFELTRO SHORT STOCK — 20-GA, 3" MSRP \$1,120
Satin walnut

12½" LENGTH OF PULL

MONTEFELTRO SILVER



NEW **MONTEFELTRO SILVER** — 12-GA, 3" MSRP \$1,535
AA-Grade satin walnut

NEW **MONTEFELTRO SILVER** — 20-GA, 3" MSRP \$1,535
AA-Grade satin walnut

Light, slender and quick pointing never described a semi-auto, better than the Benelli Montefeltro. The Inertia Driven® system allows the Montefeltro's fore-end to be slim and graceful while the lightweight anodized aluminum receiver keeps weight to a minimum.

MONTEFELTRO SILVER — 12-and 20-ga.
Upland quail & pointer



New this year is the Montefeltro Silver in 12-and 20-gauge. Both guns feature a distinctive single-piece, nickel-plated alloy receiver, complete with scroll engraving, gold embellishments and a beautifully figured, AA-Grade, satin finished, walnut stock.

FEATURES

ULTRA LIGHT STANDARD FEATURES

- CHOKE TUBES:** IC, M, F Crio® choke tubes and wrench.
- FINISH:** Satin walnut / WeatherCoat™.
- RECOIL PAD:** Gel recoil pad for shock absorption.
- SHIM KIT:** For adjustment of drop and cast.
- HARD CASE:** Custom fitted hard case to protect in transport.

MONTEFELTRO STANDARD FEATURES

- CHOKE TUBES:** C, IC, M, IM, F and wrench.
- FINISH:** Satin walnut (Montefeltro Silver: AA-Grade satin walnut).
- RECOIL PAD:** Vented recoil pad for shock absorption. (12-gauge only)
- SHIM KIT:** For adjustment of drop and cast.
- HARD CASE:** Custom fitted hard case to protect in transport.



The Benelli Montefeltro's trigger guard provides extra room for the shooter's hand, along with a stylish gold plated trigger.



Grooving at the top of the receiver extends the sight plane for fast and consistent target acquisition.





NEW

M2 FIELD, COMFORTECH™ — 12-GA, 3" MSRP \$1,365
Realtree® APG HD™

LEFT-HAND MODELS

It seems that southpaws have always been ignored by gun manufacturers. Over the years their choices have been few, and in many cases, limited to cosmetic changes to right-hand guns. Benelli has changed that minority status and produced a selection of semi-autos especially for the left-handed shooter. It's only fitting considering that Benelli offers the largest selection of semi-automatic shotguns in the world.

The Benelli flagship semi-auto; the Super Black Eagle II, is made in a left-hand version with a specially designed ComforTech™ stock that features a gel pad that is ergonomically shaped to fit the left shoulder pocket. The Benelli workhorse M2 Field also comes with left-handed ComforTech™ and, like the SBE II, in two patterns of camo or black synthetic. The classic Montefeltro left-hand comes stocked with satin finished walnut.

With three different left-hand models, a variety of barrel lengths, stock configurations and camo patterns, there's a southpaw gun for every occasion.



No longer does the left-handed shooter have to put up with hulls ejecting across his or her face. These are true left-hand guns with ejection ports on the left side of the receiver as well as a safety button that doesn't require reaching around the trigger guard to activate.

This special synthetic raised gel-comb insert not only cushions the shooter's cheek during recoil, it also allows the cheek to slide along the surface for added comfort.



Raised Comb

Standard Comb

FEATURES

STANDARD FEATURES

- CHOKE TUBES:** C, IC, M, IM, F and wrench.
- FINISHES:** Realtree® APG HD™, Advantage® Max-4 HD™, Advantage® Timber HD™, Black synthetic or Satin walnut.
- SHIM KIT:** For adjustment of drop and cast.
- HARD CASE:** Custom fitted hard case to protect in transport.

OPTIONAL FEATURES

- CHOKE TUBES:** Extended chokes for pass shooting, over the decoys waterfowl shooting and extra-full turkey.
- BARRELS:** Variety of lengths and finishes.

LEFT-HAND — 12 GAUGE



SUPER BLACK EAGLE II, COMFORTECH™ — 12-GA, 3½" MSRP \$1,700
Advantage® Max-4 HD™



SUPER BLACK EAGLE II, COMFORTECH™ — 12-GA, 3½" MSRP \$1,580
Black synthetic

M2 FIELD, COMFORTECH™ — 12-GA, 3" MSRP \$1,365
Advantage® Timber HD™



MONTEFELTRO — 12-GA, 3" MSRP \$1,120
Satin walnut

COMFORTECH™ GEL RECOIL PADS

The Benelli engineers have thought of everything. There's even a gel recoil pad on the SBE II and M2 specifically designed to fit the left shoulder. The ergonomic shape spreads the impact over a larger area for less felt recoil.



Optional Medium Pad
14" L.O.P.

Standard Pad
14½" L.O.P.



Optional Short Pad
13½" L.O.P.



A dimpled grip checkering pattern called AirTouch™ gives the shooter a firm grasp on the pistol grip and fore-end, hot or cold, wet or dry.

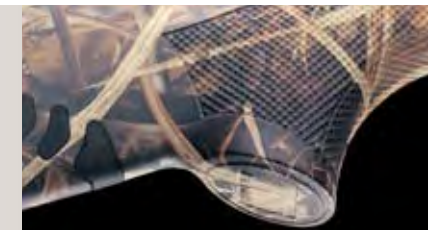

Easily change the pull length of your SBE II or M2. Insert an optional gel recoil pad to reduce the L.O.P. to 13½" or 14". Both pads have excellent recoil reducing properties. (specify left-hand when ordering).



INERTIA DRIVEN

ComforTech



SUPERNOVA COMFORTECH™ — 12-GA, 3½" MSRP \$455
Realtree® APG HD™

SUPERNOVA

The Benelli SuperNova is a completely new modular design concept in pump action shotguns.

With the optional SteadyGrip™ stock, the SuperNova can be transformed into a high-performance turkey gun or mount the optional cantilevered, fully-rifled slug barrel for tack driving accuracy on deer. There's even

a barrel with rifle sights for home defense, and a SuperNova Tactical fitted with a ghost-ring rear sight and pistol grip.

At the heart of this new pump gun is a lightweight steel skeleton framework over-molded with a high-tech polymer, making the new SuperNova super light, super strong and almost completely impervious to any weather condition.

But the SuperNova isn't just tough on the outside, with its dual-action bars and two-lug rotary bolt head that locks up steel-to-steel inside the barrel, the SuperNova is rock solid to the core. Because the new SuperNova is built tough it makes no compromises. Chambered for 2¾" and 3" shells and 3½" magnum turkey loads, this pump gun can do it all.



The SuperNova is available with a choice of three modular buttstocks and can be quickly reconfigured with a simple ratchet wrench. All three stocks are made of tough synthetic and have a textured matte finish to provide years of reliable service.

SUPERNOVA FIELD CONFIGURATION OPTIONS



SUPERNOVA COMFORTECH™ — 12-GA, 3½" MSRP \$455
Black synthetic

NEW SUPERNOVA COMFORTECH™ — 12-GA, 3½" MSRP \$545
Realtree® APG HD™

SUPERNOVA COMFORTECH™ — 12-GA, 3½" MSRP \$545
Advantage® Max-4 HD™

NEW SUPERNOVA STEADYGRIP™ — 12-GA, 3½" MSRP \$560
Advantage® Timber HD™
(Burriss Speed Dot scope not included)

SUPERNOVA SLUG CONFIGURATION OPTIONS



CANTILEVER RIFLED BARREL — 12-GA, 3" MSRP \$210
(24" rifled slug barrel sold as package or separately)

SUPERNOVA FIELD & SLUG COMBO — 12-GA, 3½" MSRP \$655
Black synthetic
(Includes 26" field barrel and 24" cantilever rifled slug barrel)

SUPERNOVA — 12-GA, 3½" MSRP \$645
Black synthetic
(Raised Comb, Burriss™ Speed Dot scope not included)

SUPERNOVA TACTICAL CONFIGURATION OPTIONS

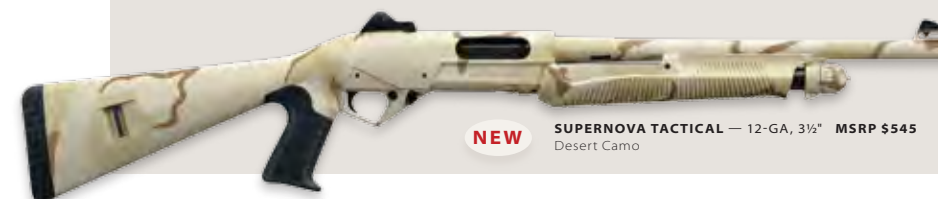

NEW SUPERNOVA TACTICAL — 12-GA, 3½" MSRP \$545
Desert Camo



The SuperNova won the prestigious Shooting Academy of Excellence Award as the 2006 Shotgun of the Year. The Academy honors companies, products and individuals who best represent excellence within the shooting industry.



STANDARD FEATURES

- CHOKE TUBES:** IC, M, F and wrench.
- FINISHES:** Realtree® APG HD™, Advantage® Max-4 HD™, Advantage® Timber HD™ or Black synthetic.
- COMB PAD:** Standard height gel comb pad.
- SHIM KIT:** For adjustment of drop and cast.

FEATURES

OPTIONAL FEATURES

- CHOKE TUBES:** Extended chokes for pass shooting, over the decoys waterfowl shooting and extra-full turkey.
- GEL RECOIL PADS:** Three options to customize length-of-pull to 13½", 14" or 14½".
- BARRELS:** Variety of lengths and finishes in both field and slug barrels.



This special synthetic insert, cushions the shooter's cheek during recoil, and is available in 3 comb sizes, for ComforTech® stocks only.

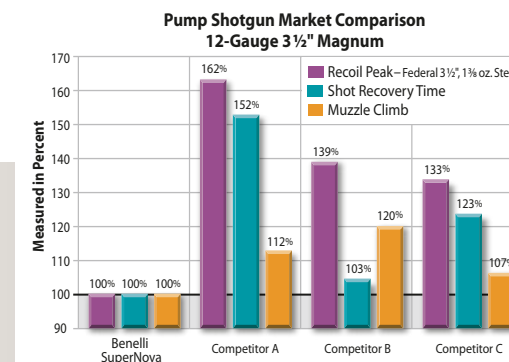

In comparison to its competitors, the SuperNova with ComforTech™ reduces felt recoil by as much as 62%, shot recovery time by as much as 52%, and muzzle climb by as much as 33%. The comparison test used Federal's 3½" 1½ oz. steel load.

NOVA PUMP



NOVA PUMP — 12-GA, 3½" MSRP \$455
Advantage® Max-4 HD™

NOVA PUMP — 12 GAUGE



NOVA PUMP — 12-GA, 3½" MSRP \$455
Advantage® Timber HD™



NEW NOVA PUMP — 12-GA, 3½" MSRP \$455
Realtree® APG HD™

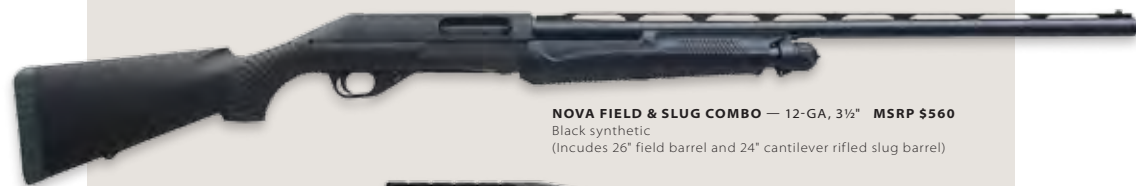

NOVA FIELD & SLUG COMBO — 12-GA, 3½" MSRP \$560
Black synthetic
(Includes 26" field barrel and 24" cantilever rifled slug barrel)



CANTILEVER RIFLED BARREL — 12-GA, 3" MSRP \$210
(24" rifled slug barrel sold as package or purchased separately)

NOVA PUMPS ONE-PIECE SKELETON FRAME

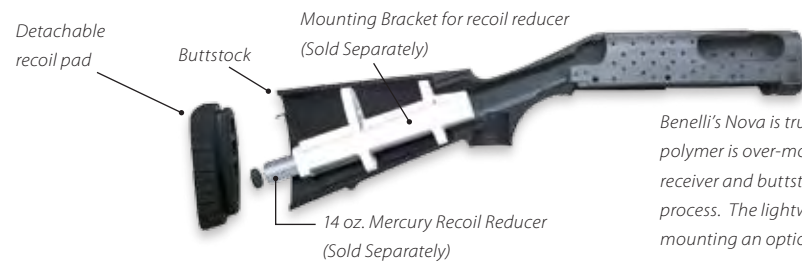

Benelli's Nova is truly a 21st Century pump shotgun. Corrosion proof polymer is over-molded on a skeleton framework to form the one-piece receiver and buttstock, in a revolutionary shotgun manufacturing process. The lightweight polymer stock also provides plenty of room for mounting an optional 14 oz. recoil reducer.

STANDARD FEATURES

CHOKE TUBES: IC, M, F and wrench.
FINISHES: Realtree® APG HD™, Advantage® Max-4 HD™, Advantage® Timber HD™ or Black synthetic.

FEATURES

OPTIONAL FEATURES

CHOKE TUBES: Extended chokes for pass shooting, over the decoys waterfowl shooting and extra-full turkey (12 gauge only).
RECOIL REDUCER & BRACKET: 14 oz. recoil reducer and mounting bracket (sold separately).
BARRELS: Variety of lengths and finishes in both field and slug barrels.



Just when everyone thought that the pump action shotgun couldn't be improved, Benelli unveiled the Nova Pump. Completely original and innovative, the Nova Pump incorporates its polymer stock and lightweight receiver into a single unit for unsurpassed strength and weather resistance. Italian styling and high-tech ergonomics, such as distinctive grooves on the pistol grip and fore-end in place of conventional checkering, compliment the Nova's innovative engineering.

With dual-action bars and rotary head locking lugs, the Nova will handle anything from target loads to 3½" magnums. To help dampen the recoil of today's super-heavy magnum loads, the Nova 12-gauge is specially designed to accept a Benelli recoil reducer.

Available in black, Advantage® Max-4 HD™, Timber HD™ and new Realtree® APG HD™ finishes, and as a youth model or slug gun combo set, the Benelli Nova is the most versatile pump-action shotgun ever made — and just when everyone thought the pump gun couldn't be improved.

NOVA PUMP — 20 GAUGE



NEW NOVA PUMP — 20-GA, 3" MSRP \$455
Realtree® APG HD™



NOVA PUMP — 20-GA, 3" MSRP \$560
Black synthetic



NOVA PUMP SHORT STOCK — 20-GA, 3" MSRP \$465
Black synthetic

13" LENGTH OF PULL



Adjustable length-of-pull with optional ComforTech™ gel recoil pad insert.

The 20-gauge Nova is perfect for the growing shooter. The stock can be shortened, and optional recoil pads are available for the desired length-of-pull.



20-ga. Short Pad 13 ¾" L.O.P.
20-ga. Short Stock Pad 12 ½" L.O.P.

The button on the underside of the fore-end activates a shell stop, allowing a chambered shell to be removed without releasing rounds from the magazine.

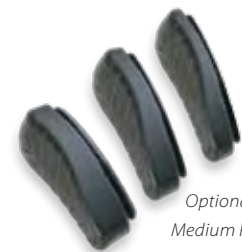

Optional Short Pad 13½" L.O.P.
Optional Medium Pad 14" L.O.P.
Optional Long Pad 14 ¾" L.O.P.

Checkering is fine for wood stocks, but the Nova uses distinctive grooves that give both unmatched gripping surfaces and an unforgettably distinctive look.

NEW **SUPERNOVA, COMFORTECH™** — 12-GA, 3" (shown with optional cantilever slug barrel)
Black synthetic — (Burris® 1.75x-5x scope, not included)



SLUG GUNS — 12 GAUGE



M2, COMFORTECH™ — 12-GA, 3" **MSRP \$1,400**
Advantage® Timber HD™
(shown with optional Burris® 1.75x-5x scope,
and optional extra-high comb pad not included)

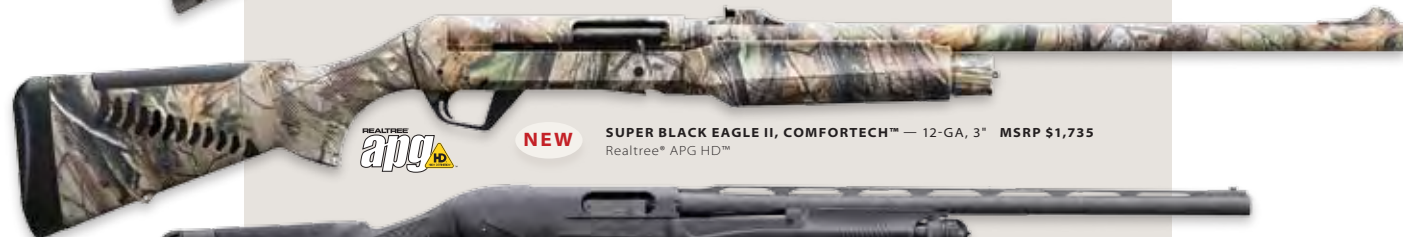

NEW **SUPER BLACK EAGLE II, COMFORTECH™** — 12-GA, 3" **MSRP \$1,735**
Realtree® APG HD™



SUPERNOVA FIELD & SLUG COMBO — 12-GA, 3½" **MSRP \$655**
Black synthetic



CANTILEVER RIFLED BARREL — 12-GA, 3" **MSRP \$210**
Black synthetic
(24"rifled barrel sold as package or separately)

The Field & Slug barrel combo is available in both the SuperNova and Nova Pump shotguns. The rifled slug barrel comes complete with a cantilever to allow scope mounting. This combo allows complete versatility filling the need whether hunting birds or deer.

OPTICS PACKAGE



Burris® Speed Dot —comes with Weaver style rings and base for easy mounting and has 11 brightness settings for the illuminated dot reticle (available in Advantage® Timber HD™).



Optional ComforTech™ gel recoil pad to adjust length-of-pull with for your SBE II, M2, Nova and SuperNova.

Burris® 1.75x - 5x scope — designed especially for shotguns, comes with rings and Weaver style base (see page 39 for more details).



Optional Short Pad 13½" L.O.P.

Optional Medium Pad 14" L.O.P.

Standard Pad 14¾" L.O.P.

FEATURES

STANDARD FEATURES

BARRELS: Fully rifled slug barrel.
FINISHES: Realtree® APG HD™, Advantage® Timber HD™, Black synthetic or Satin walnut.
DRILLED & TAPPED: All rifled slug gun receivers are drilled and tapped for scope mounting.

OPTIONAL FEATURES

GEL RECOIL PADS: Three options to customize length-of-pull to 13½", 14" or 14¾".
RAISED COMB PADS: Extra-high and raised comb inserts for scoped hunting.
BARRELS: Variety of lengths and finishes in both field and slug.

SLUG GUNS

"Slug gun only" deer hunting areas are increasing across the country. Following the trend, Benelli engineers designed slug guns to give the accuracy and performance hunters have come to expect.

The heart of the new Benelli slug gun is a specially designed, heavy-walled 1:28" twist rifled barrel that gives accuracy undreamed of in conventional smooth bore slug guns. The Super Black Eagle II, M2 12-gauge, new M2 20-gauge and Nova Pump and new SuperNova slug guns come standard with barrel mounted, fully adjustable rear sights, fixed blade front sights and specially designed receivers drilled and tapped for optic sights.

Black synthetic, Advantage® Timber HD™, Realtree® APG HD™ or walnut stocks are available for the SBE II. Also available for the SBE II, M2 Field and SuperNova slug models is the ComforTech™ stock that reduces felt recoil by as much as 48%.



SLUG GUNS — 12 GAUGE



NEW **M2, COMFORTECH™** — 20-GA, 3" **MSRP \$1,280**
Black synthetic



NOVA PUMP — 20-GA, 3" **MSRP \$640**
Advantage® Timber HD™



The Benelli's adjustable rear and fixed blade front sights will get the job done in any weather.



This special synthetic raised gel-comb insert not only cushions the shooter's cheek during recoil, it also allows the cheek to slide along the surface for added comfort. (Available for ComforTech™ models only.)



SBE II and M2 models accept a Weaver 93 base. The Nova 12-gauge and SuperNova use a Weaver 423M.



Benelli recommends Federal Premium® Vital-Shok™ 12ga.- 1-oz./20ga.- ¾-oz. Barnes Expander™ Slugs for optimum performance in fully-rifled slug barrels.



TURKEY GUNS



SUPER BLACK EAGLE II STEADYGRIP™ — 12-GA, 3½" MSRP \$1,615
 Advantage® Timber HD™

TURKEY GUNS — 12 GAUGE

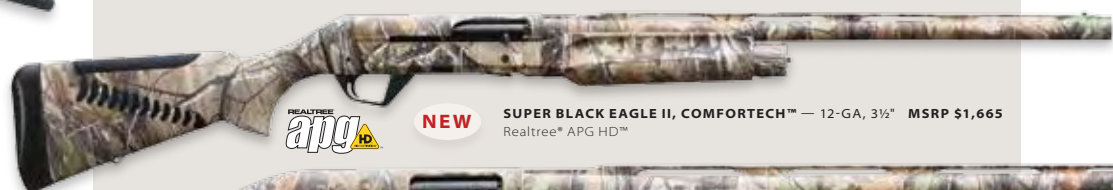

NEW SUPER BLACK EAGLE II, COMFORTECH™ — 12-GA, 3½" MSRP \$1,665
 Realtree® APG HD™



NEW M2 FIELD, STEADYGRIP™ — 12-GA, 3" MSRP \$1,375
 Realtree® APG HD™



M2 FIELD, COMFORTECH™ — 12-GA, 3" MSRP \$1,335
 Advantage® Timber HD™
 (Shown with optional ComforTech™ extra-high comb pad and Burris® Speed Dot optics)



SUPERNOVA, STEADYGRIP™ — 12-GA, 3½" MSRP \$560
 Advantage® Timber HD™
 (Shown with optional Burris® Speed Dot optics)



NOVA PUMP — 12-GA, 3½" MSRP \$455
 Advantage® Timber HD™

The extra-full turkey choke is specially designed to throw tight, uniform patterns with today's modern turkey loads (optional).

FEATURES

STANDARD FEATURES

CHOKE TUBES: C, IC, M, IM, F for SBE II and M2. IC, M, F for SuperNova and Nova.
FINISHES: Realtree® APG HD™, Advantage® Timber HD™ or Black synthetic.
DRILLED & TAPPED: SBE II and SteadyGrip™ receivers are drilled and tapped for scope mounting.

OPTIONAL FEATURES

GEL RECOIL PADS: Three options to customize length-of-pull to 13½", 14" or 14¾".
RAISED COMB PADS: Three options to customize sight plane for scoped hunting (not available for SteadyGrip™ models).
BARRELS: Variety of lengths and finishes in both field and slug barrels.



No matter what your style of turkey hunting, there's a Benelli shotgun for the job. If you demand the ultimate ballistics of the 3½" 12-gauge, choose the Super Black Eagle II. The new ComforTech™ system stock will take the sting out of those 2-ounce loads. The same ComforTech™ recoil-reducing magic can be had in the 3" magnum M2 Field.

The turkey is the only game bird generally hunted from a static sitting position. To get the rifle-like accuracy needed, choose the guns voted "Shotgun of the Year." The M2 Field, Super Black Eagle II or the new SuperNova with the SteadyGrip™ allows a comfortable, rock-solid grip. A comfortable sitting position makes it easier to wait patiently for that savvy old Tom.

Prefer a pump? The new SuperNova and Nova 12-gauge shoot 3½" ammunition and are the smoothest pumping slide-actions on the market today. Like the lighter weight and recoil of a 20-gauge? Choose the M2 Field or Nova Pump.



TURKEY GUNS — 20 GAUGE



M2 COMFORTECH™ — 20-GA, 3" MSRP \$1,335
 Realtree® APG HD™



NOVA PUMP SHORT STOCK — 20-GA, 3" MSRP \$455
 Black synthetic

13" LENGTH OF PULL



The SteadyGrip™ lets you sit comfortably as the most skittish gobbler winds his way to your call.



Benelli's gel recoil pad was designed with extensive computer modeling so precise that there are different pads for right- and left-handers. (Must specify right- or left-hand).



LEFT RIGHT



Optional Short Pad 13½" L.O.P.
 Optional Medium Pad 14" L.O.P.
 Standard Pad 14¾" L.O.P.

Adjustable length-of-pull with optional ComforTech™ gel recoil pad insert. Fits your SBE II, M2, Nova or SuperNova. (Not available for wood gun stocks).



Optional special synthetic extra-high gel-comb insert not only cushions the shooter's cheek during recoil, it also allows the cheek to slide along the surface for added comfort. (Available for ComforTech™ gun only.)



Optional Burris™ Speed dot: comes with Weaver style base and rings for easy mounting. It features a 35-mm main tube, fully coated lenses and 11 brightness settings for the illuminated dot reticle. All in Advantage® Timber HD™.

DEFENSE

M4 CONFIGURATION OPTIONS

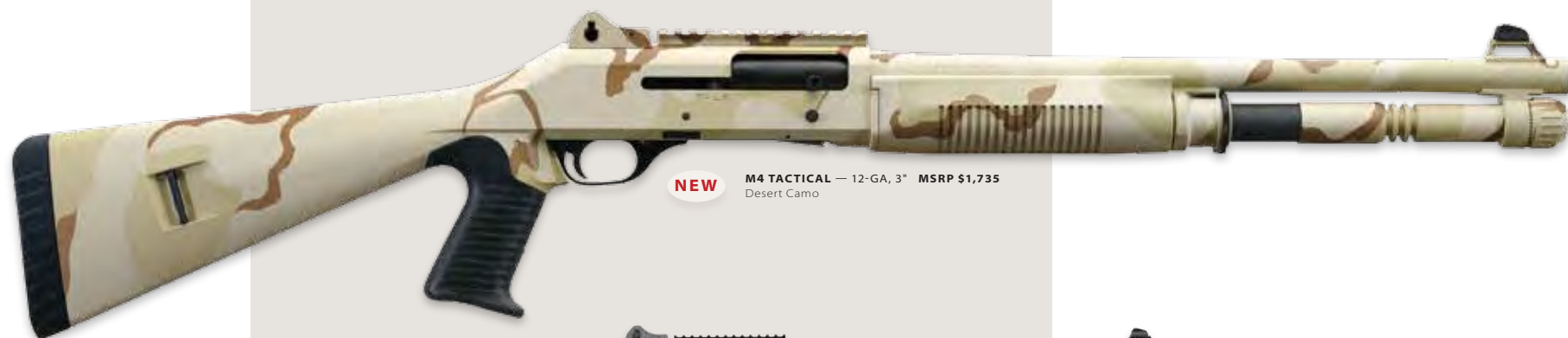

NEW M4 TACTICAL — 12-GA, 3" MSRP \$1,735
Desert Camo



M4 TACTICAL — 12-GA, 3" MSRP \$1,735
Black synthetic

M4 STOCK OPTIONS



M4 STANDARD STOCK

All three durable stocks are made of tough synthetic and have a textured matte black finish to provide years of reliable service and withstand the rigors of everyday use.



M4 SKELETONIZED PISTOL GRIP STOCK

Developed for the Benelli tactical shotgun, adopted by the U.S. Marine Corps, this optional collapsible skeleton stock is now available to civilians. Quick and easy, the stock is length adjustable to three positions with the push of a button.

M4 ARGO SYSTEM



DUAL SELF-CLEANING PISTONS
The stainless steel pistons are required to move only 1/2" for complete cycling which results in a faster operation with minimum vibration and quick target acquisition.



M2 TACTICAL CONFIGURATION OPTIONS



M2 TACTICAL PISTOL GRIP — 12-GA, 3" MSRP \$1,175
Black synthetic



M2 TACTICAL, COMFORTECH™ — 12-GA, 3" MSRP \$1,280
Black synthetic



M2 TACTICAL STANDARD — 12-GA, 3" MSRP \$1,065
Black synthetic



M3

M3 CONVERTIBLE — 12-GA, 3" MSRP \$1,255
Black synthetic
The M3 Convertible Auto/Pump is a fast cycling auto for conventional loads that can be pumped manually for low energy special purpose loads such as gas, beanbag and rubber bullets.



Optional three-dot tritium inserts can be easily installed into this military spec ghost-ring sight. The rear sight is click-adjustable for both windage and elevation. These sights are intended for rough service and feature rugged "wings" to protect the removable ghost-ring and front post.



Ghost-ring sights are click-adjustable using a cartridge rim, and can be ordered with tritium inserts for low-light situations. A Picatinny rail allows the mounting of scopes, red dot sights or night vision optics.

FEATURES

STANDARD FEATURES

CHOKE TUBES: C on M-4; IC, M, F on M2; Fixed C on M3 Convertible.
FINISHES: Black synthetic (M4: Black synthetic / Desert camo).
SIGHTS: M4: ghost-ring sights; M2 Tactical and M3: Ghost-ring or open rifle.
DRILLED & TAPPED: M4 receivers are drilled and tapped with a Picatinny rail.

OPTIONAL FEATURES

GEL RECOIL PADS: Three options to customize length-of-pull to 13 1/2", 14" or 14 3/8" (M2 Tactical models only).
MODULAR STOCKS: Variety of Black synthetic modular stocks.
TRITIUM INSERTS: Three dot tritium inserts available for ghost-ring sights.



Optional Short Pad 13 1/2" L.O.P.
Optional Medium Pad 14" L.O.P.
Standard Pad 14 3/8" L.O.P.

BENELLI'S MODULAR STOCK SYSTEM

The M2 and SuperNova are available with a choice of modular synthetic buttstocks and can be quickly reconfigured with a simple ratchet wrench. All stocks are made of tough synthetic and have a textured matte black finish to provide years of reliable service.





NEW SUPERNOVA TACTICAL — 12-GA, 3½" MSRP \$545
Desert Camo

DEFENSE

Benelli's SuperNova Tactical is a modular concept pump action shotgun, that can be quickly reconfigured with any of three different special-purpose stocks to be ready for any home defense or tactical situation.

The ComforTech™ stock absorbs nearly 48% of felt recoil to dampen the jolt of heavy buck shot loads. In addition to taming recoil, the ComforTech™ system minimizes muzzle rise, putting you back on target twice as fast as other comparable shotguns.

The tactical pistol grip stock turns the SuperNova into a rock solid shooting platform for optical sights and slugs at long yardage. It also has the added advantage of being easy to manipulate one-handed.

For tight quarters when clearing buildings or in a patrol vehicle, nothing beats the compact versatility of the SuperNova with the collapsible tactical stock (for law enforcement only). The Benelli SuperNova is a high-tech tactical shotgun designed for professionals, but perfect for your home.



The button on the underside of the fore-end of the SuperNova activates a shell stop that allows the chambered shell to be removed without releasing rounds from the magazine.

BENELLI'S MODULAR STOCK SYSTEM



Benelli's SuperNova Tactical can be quickly reconfigured with a choice of three different modular buttstocks:

1. The stocks slide easily into position on the post that is shown in the pull-away view.
2. The raised alignment studs on the buttstock, align perfectly with the indent shown on the back end of the receiver.
3. Simply tighten bolt through rear of stock and replace buttpad.



Optional Short Pad 13½" L.O.P.

Optional Medium Pad 14" L.O.P.

Optional Long Pad 14¾" L.O.P.

FEATURES

STANDARD FEATURES

- CHOKE TUBES:** Fixed Cylinder.
- FINISHES:** All models available in Black synthetic, SuperNova also available in Desert camo.
- SHIM KIT:** For adjustment of drop and cast (available for SuperNova ComforTech™ model only).
- SIGHTS:** Ghost-ring or open rifle.

OPTIONAL FEATURES

- GEL RECOIL PADS:** Three options to customize length-of-pull to 13½", 14" or 14¾"
- MODULAR STOCKS:** Variety of Black synthetic modular stocks.
- TRITIUM INSERTS:** Three dot tritium inserts available for ghost-ring sights.



SUPERNOVA TACTICAL — 12 GAUGE



SUPERNOVA TACTICAL, PISTOL GRIP — 12-GA, 3½" MSRP \$455
Black synthetic



SUPERNOVA TACTICAL, COMFORTECH™ — 12-GA, 3½" MSRP \$440
Black synthetic

NOVA PUMP TACTICAL — 12 GAUGE



NOVA PUMP TACTICAL — 12-GA, 3½" MSRP \$375
Black synthetic



NOVA PUMP H₂O TACTICAL — 12-GA, 3½" MSRP \$535
Black synthetic, matte nickel

The Nova Pump Tactical comes with either open rifle sights or a click-adjustable military style ghost-ring for this all-business, no-nonsense tool. The Nova H₂O Pump Tactical utilizes a polymer stock and corrosion-resistant stainless steel with chrome and nickel plated components to ensure that it keeps working in even the harshest conditions.

The SuperNova comes with newly designed, military-style ghost-ring sights. The rear sight is click adjustable for both windage and elevation. Optional three-dot tritium inserts can be easily installed (see page 39).



REAR SIGHT



FRONT SIGHT



The top of the SuperNova Tactical's receiver is drilled and tapped to accommodate easy attachment of military-style ghost ring sights or a scope.

BENELLI'S NOVA PUMP H₂O COATING

The barrel, magazine tube, magazine cap, trigger group and all other inner metal parts are nickel-plated on the Nova H₂O to survive the wettest, saltiest environments.



With a chrome-plated rotary bolt head and a matte nickel-finished bolt body, the Nova Pump H₂O is ready to take on the harshest weather and keep on firing.





R1 RIFLE, COMFORTECH™ — .300 WIN MAG MSRP \$1,435
Black synthetic — with GripTight™ coating

R1 RIFLE

BENELLI'S GRIP TIGHT™ COATING



The Benelli R1 with ComforTech™ features a high-tech texturing on both the stock and fore-end called GripTight™. This synthetic over-coating feels almost tacky to the touch, so consequently, gives a sure grip wet or dry, with bare hands or even gloves. GripTight™ is totally weather resistant and completely bonded to the surface of the synthetic material of the stock and fore-end.

R1 RIFLE COMFORTECH®



NEW

R1 RIFLE, COMFORTECH™ — .30-06 SPRINGFIELD MSRP \$1,565
Realtree® APG HD™ — shown with optional extra-high comb.
(Optional interchangeable barrels are available in a variety of lengths and calibers)

OPTIONAL INTERCHANGEABLE BARRELS



24" .300 WIN. MAG., .300 WSM, .270 WSM

22" .30-06 SPRINGFIELD, .308 WIN

20" .30-06 SPRINGFIELD, .300 WIN. MAG.,

This optional special synthetic raised gel comb insert not only cushions the shooter's cheek during recoil, it also allows the cheek to slide along the surface for added comfort.



Just imagine a .300 Winchester Magnum that feels like you're shooting a light .270 and you'll understand what this rifle from Benelli is all about. The R1, with its ComforTech™ recoil dampening stock, cuts felt recoil. To put it more graphically, other high-powered rifles kick about twice as hard.

Three different thicknesses of quick-change pads for adjusting length-of-pull and three different comb inserts to adjust for drop are available. Also included is a totally unique accessory — a shim kit to make precise stock adjustments for drop and cast providing a truly custom fit.

FEATURES

STANDARD FEATURES

- FINISHES:** Realtree® APG HD™, GripTight™ over Black synthetic or AA-Grade satin walnut.
- BARRELS:** Crio™ treated barrels.
- SHIM KIT:** For adjustment of drop and cast.
- DRILLED & TAPPED:** All R1 receivers are drilled and tapped for scope mounting and come equipped with a Picatinny rail.

OPTIONAL FEATURES

- GEL RECOIL PADS:** Three options to customize length-of-pull to 13½", 14" or 14¾" (ComforTech™ only).
- RAISED COMB PADS:** High and extra-high raised comb pads for scoped hunting (ComforTech™ only).
- BARRELS:** Interchangeable barrels with matching bolt heads are available in a variety of calibers.



Optional open sights feature a fully adjustable rear blade and front sight with a special red filament insert.

R1 RIFLE



R1 RIFLE — .300 WIN MAG MSRP \$1,205
AA-Grade satin walnut
(shown with optional R1 Rifle sight package)

Optional interchangeable barrels are available in different lengths and calibers:
.270 WSM (available in 24")
.300 WIN MAG (available in 20" and 24")
.30-06 SPRINGFIELD (available in 20" and 22")
.300 WSM (available in 24")
.308 WIN (available in 22")



Usually only found on custom-made rifles, the R1's barrel is cryogenically frozen to -300° F which changes the steel at the molecular level. The result, better barrel harmonics providing superior accuracy.

Quick detachable magazine holds three to four rounds, depending on caliber.



The R1 is perfect for shooters of all sizes. Optional recoil pads are available for the desired length-of-pull (13½", 14", 14¾").

AUTO-REGULATING GAS-OPERATED (ARGO) SYSTEM

The reliability of the R1's auto-regulating gas-operated (ARGO) system has been proven in the M1014 military shotgun and has been adapted for centerfire rifle cartridges with a three-lugged rotary bolt. The rifle's gas cylinder is positioned just in front of the chamber allowing for short operating rods and reduced recoiling mass.

Chamber pressure is contained by the massive three-lug rotary locking head, which locks into the steel barrel extension.

GAS PORT

The gas port is located just forward of the chamber where the gases are hotter and cleaner resulting in less fouling and more reliable cycling.

SIMPLE DESIGN GAS PISTONS

Two short stroke, self-cleaning gas pistons push directly against the R1's bolt body, eliminating the need for connecting linkage or heavy action bars.



PISTONS

Since the pistons push directly against the bolt, they are required to move only ½-inch for complete cycling which results in fast operation with minimum vibration.

TORQUE LOCKING SYSTEM

System ensures repeatable accuracy when changing barrels, because tension remains constant shot-after-shot.



PARTS & ACCESSORIES

STOCKS AND FORE-ENDS SYNTHETIC

M2/SUPER BLACK EAGLE II
Advantage™ Timber HD™



M2/SUPER BLACK EAGLE II
Advantage™ Max-4 HD™



M2/SUPER BLACK EAGLE II
Synthetic Field



STEADYGRIP™

STEADYGRIP™
Advantage™ Timber HD™
(specify model)



M2/SUPER BLACK EAGLE II
SUPERNOVA



NEW

STEADYGRIP™
Advantage™ Max-4 HD™
(specify model)



M2/SUPER BLACK EAGLE II
SUPERNOVA



NEW

STEADYGRIP™
Realtree™ APG HD™
(specify model)



M2/SUPER BLACK EAGLE II
SUPERNOVA



WOOD

M2/SUPER BLACK EAGLE II
— 12ga./20ga.
Satin walnut



EXECUTIVE — 12ga./20ga.
AAA-Select Grade
oil-finished walnut



MONTEFELTRO / LEGACY
— 20ga.
Short Stock — Satin walnut



MONTEFELTRO / LEGACY
— 12ga./20ga.
Satin walnut



MONTEFELTRO / LEGACY
— 12ga./20ga.
A-Grade satin walnut



Stocks and fore-ends sold separately.

R1 RIFLE RECOIL PADS

The R1 is perfect for shooters of all sizes. Optional recoil pads are available for the desired length of pull (13 5/8", 14", 14 3/8").

RECOIL PADS



13 5/8" Length of pull 14" Length of pull 14 3/8" Length of pull 13 1/2" Length of pull 14" Length of pull 14 3/8" Length of pull

COMFORTECH™ GEL RECOIL PADS

Easily change the pull length of your SBE II, M2, Nova or SuperNova. Insert an optional gel recoil pad to reduce the L.O.P. to 13 1/2" or 14". All pads have excellent recoil reducing properties (specify right- or left-hand).

PISTOL GRIPS

M2 AND M3 PISTOL GRIP
Synthetic Non-Adjustable Drop
(specify model)



SUPERNOVA PISTOL GRIP
Synthetic



M4 SKELETONIZED WITH PISTOL GRIP
Synthetic



BARRELS



SUPER BLACK EAGLE II — 28"
(26" and 24" available)
(Fits SBE II and SBE)

SUPER BLACK EAGLE II RIFLED SLUG — 24"
(Fits SBE and SBE II)

SUPERNOVA AND NOVA TACTICAL BARREL — 18 1/2"
(with open rifle or ghost-ring sights)

SUPERNOVA AND NOVA PUMP RIFLED SLUG WITH CANTILEVER — 24"
(Available in Advantage™ Timber HD™ and Matte black) (right-hand only)

SUPERNOVA AND NOVA PUMP — 26"
(24" and 28" available)

M2 FIELD — 26"
(24" and 28" available)
(Fits M1 and M2)

MONTEFELTRO / LEGACY — 12- or 20-GAUGE — 24"
Blued
(26" available)

★ All barrels available in Realtree™ APG HD™ Advantage™ Timber HD™ Advantage™ Max-4 HD™ and Matte black

Add versatility to your Benelli shotgun with an extra barrel. Complement your smooth-bore gun with an extra slug barrel or have the opportunity to switch barrel lengths from 24" to 26" to 28", whichever fits your particular hunting needs. Extra barrels are available for all models. Rifled slug barrels are available for Super Black Eagle, Super Black Eagle II, M1 Field, M2 Field, SuperNova and Nova models only. (For SBE, SBEII, M1 and M2 models, slug barrels require a modified fore-end sold separately).

Extra-high Comb



GEL COMB INSERTS

The ComforTech™ stock comb insert is made from a special synthetic gel originally developed for the medical industry. This special insert not only cushions the shooter's cheek during recoil, it also has a slippery surface that allows the cheek to slide along the surface for added comfort. Available in standard thickness, raised comb for target shooting or extra-high comb for scoped guns.

Extra-high Comb



Raised Comb

Standard Comb

PARTS & ACCESSORIES

CHOKE TUBES AND ACCESSORIES



STANDARD CHOKES



STANDARD CHOKES
Standard choke tubes in 12-gauge and 20-gauge are available in cylinder, improved cylinder, modified, improved modified and full.

Standard tubes in 12-gauge and 20-gauge are available in cylinder, improved cylinder, modified, improved modified and full.

CRIO® CHOKES



CRIO® CHOKES
Crio® Choke tubes in 12- or 20-gauge are available in cylinder, improved cylinder, modified, improved modified and full.

THREE SPECIAL FIELD CRIO® CHOKES

Three special field Crio® Choke tubes: a turkey choke specially designed to throw tight, uniform patterns with today's modern turkey loads, a pass shooting choke for long range waterfowl pass shooting and an over-the-decoys waterfowl choke.



(A) Turkey Shooting, (B) Pass Shooting, (C) Decoy Shooting

EXTENDED SPORTING CHOKES



EXTENDED SPORTING CRIO® CHOKES™
Chrome plated Crio® Choke Tubes are available in cylinder, improved cylinder, modified, improved modified and full.

EXTENDED STANDARD CHOKES



EXTENDED STANDARD CHOKES
Extended standard choke tubes are available in cylinder, improved cylinder, modified, improved modified and full (12-gauge only).



(A) Turkey Shooting, (B) Pass Shooting, (C) Decoy Shooting



NOVA CHOKE TUBE WRENCH
12- or 20-gauge (Specify 12- or 20-gauge when ordering).

BURRIS® SPEED DOT PACKAGE

in Advantage® Timber HD™

The Burris® Speed Dot comes with Weaver style rings and base for easy mounting and features a 35-mm main tube, fully coated lenses and 11 brightness settings for the illuminated dot reticle. The Burris® speed dot is shock resistant, waterproof and a perfect sight for a slug gun or tight bore turkey gun.

Burris® Speed Dot Scope (#90420) **\$180**
(Base fits SBE II and M2 Field only).



BURRIS® SCOPES

BURRIS® 1.75-5X VARIABLE SCOPE PACKAGE

in Advantage® Timber HD™
The Burris® 1.75x – 5x scope is designed especially for shotguns and comes with rings and Weaver style base. The scope comes with the Burris® lifetime warranty.

Burris® 1.75-5x Variable Scope (#90421) **\$270**

A Weaver 93 base is included with the purchase of your Burris® optics. (base fits SBE II and M2 Field only).

R1 RIFLE SIGHT PACKAGE



Benelli offers European styled sights for the R1 Rifle. Developed in Europe for quick acquisition in heavy cover, these sights feature a fully adjustable rear blade and adjustable front sight, with a special red filament insert.

R1 Rifle Sight Package (#81131) **\$180**



TACTICAL SHOTGUN FLASHLIGHT MOUNT

Our tactical flashlight mount is made by Insight Technology Incorporated, the leading supplier of tactical lights and lasers for U.S. special operations. It allows you to aim and illuminate simultaneously, since the mounted light is co-axial with the bore. Flashlight available separately from Insight Technology Incorporated or your local Benelli dealer.

(#90039) **\$75**

GHOST-RING SIGHTS

TACTICAL



GHOST-RING TRITIUM INSERTS

When the lights go out, you'll have the advantage with these ghost-ring tritium inserts. Optional three-dot inserts can be easily installed into this military spec ghost-ring sight. The rear sight is click-adjustable for both windage and elevation with a coin or shot-shell rim. These sights are intended for rough service with rugged "wings" to protect the removable ghost-ring and front position.

(#60795) **\$90**

SUPERNOVA GHOST-RING SIGHTS



CHOKE TUBE CHART

	SBE	M-1	Montefeltro	Legacy	Ultra Light	World Class	Nova Pump	Super Nova	Sport	Sport II	Super Sport	Cordoba	M-4	M-3	SBE II	M2 (12-gauge)	M2 (20-gauge)	M2 Tactical	
STANDARD CHOKE	•	•	•	•	•	•	•	•	•	•	•	•	•	•	•	•	•	•	•
EXTENDED STANDARD CHOKE	•	•	•	•	•	•	•	•	•	•	•	•	•	•	•	•	•	•	•
CRIO® CHOKE					•				•	•	•				•	•	•	•	•
EXTENDED CRIO® CHOKE					•				•	•	•				•	•	•	•	•



PARTS & ACCESSORIES

A. MONTEFELTRO/ LEGACY/EXECUTIVE

B. M1/SUPER BLACK EAGLE
(with 4-shot magazine extension)

C. M1 TACTICAL
(with 2-shot magazine extension)

D. M1/SBE/M2/SBE II
(standard)

E. NOVA PUMP 20-GA
(standard)

F. NOVA PUMP 12-GA
(standard)



LIMITER PLUGS

BOLT HANDLES

CHAMBER LOCK

When storing or transporting your shotgun use the patented Benelli Chamber Lock for additional safety. Meets California standards (Specify 12- or 20-gauge).

BOLT HANDLES

Replacement bolt handles are available in matte and chrome (specify 12- or 20-gauge). Also for some special purpose and tactical models.

MERCURY RECOIL REDUCER

Benelli offers a mercury recoil reducer for the 12-ga. Super Black Eagle and M1 Field models with synthetic stocks. It weighs only 11 ozs. and is easily installed (no bracket is necessary).

RECOIL REDUCER BRACKET

The Nova Pump's stock has a recess for easy installation of a recoil reducer bracket which houses a 14-oz. mercury recoil reducer. When shooting the mighty 3½" magnums, this innovative system is a welcome addition.



RECOIL REDUCERS

Super Black Eagle/M1 Mercury Recoil Reducer

Nova Pump Mercury Recoil Reducer

Nova Pump Recoil Reducer Bracket

Nova Pumps one-piece skeleton frame

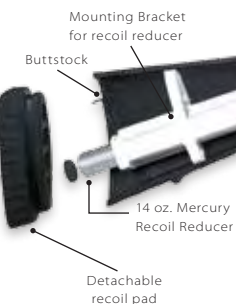

Benelli's Nova is truly a 21st Century pump shotgun. Corrosion proof polymer is over-molded on a skeleton framework to form the one-piece receiver and buttstock, in a revolutionary shotgun manufacturing process. The lightweight polymer stock also provides plenty of room for mounting an optional 14-oz. recoil reducer.



SHIM KITS

STANDARD SHIM KIT

Stock drop is user adjustable; changing shims provides a customized sighting plane to fit the individual shooter's unique physical build and shooting style (specify model).

COMFORTECH™ SHIM KIT

You can customize the models with the ComforTech™ buttstock to your personal requirements using a shim kit that adjusts both drop and cast.

BENELLI GEAR

NEW

VENTILATED SHOOTING VEST

Mesh Shooting Vest from Bob Allen Sportswear to be classed among the elite. A tough, full mesh body, black leather dual pads for ambidextrous shooting, black leather trimmed front rear reloaders pouch. Embroidered with Benelli logo. Includes Insert-A-Pad™ and built in Insert-A-Pad™ pockets.

Color: Black
Sizes: M-XL \$92
Sizes: XXL-XXX \$97



CLOTHING

BenelliUSA.GEARStore
BENELLIUSA.COM

Front Back **NEW**

NEW

SHELL POUCH

Benelli's new distinctive, heavy-duty shell pouch comes in black with the Benelli logo embroidered on the front. Twin compartments accommodate live rounds and, at the same time, provide a separate space for empty hulls.

Color: Black (#90232)
\$45



BAGS

NEW #90232

#90099

FLOATING BLIND BAG

Drop it in the drink, it's okay — not only is our blind bag waterproof, it floats. Made of rugged nylon and lined with closed-cell foam for floatation. This bag sports two side pockets, one front pocket, self-sealing coil zippers, an adjustable padded shoulder strap and 6 shell loops with a Velcro® flap. Embroidered Benelli logo. Dimensions: 18"x10"x10"

Camo pattern: Advantage® Max-4 HD™ (#90098)
\$70

Camo pattern: Realtree® APG HD™ (#90186)
\$70



#90098

#90096

NEW #90189

NEW #90231

SHELL POUCH

Twin interior compartment for empties and live shells. A large zipper opens at the bottom to quickly dump hulls. Complete with heavy-duty web belt. 22-oz. canvas with leather bottom assures durability for years to come. Embroidered Benelli logo.

Color: Flax (#90099) \$45

GEAR BAG

This rugged Benelli Gear bag has a Spacious 15" x 9" x 8" main compartment. Four zippered outer pockets.

Quick detachable padded shoulder strap. Embroidered Benelli logo.

Camo pattern: Advantage® Timber HD™ (#90096)
\$55

NEW

RANGE BAG

When camo is not necessary, this black Gear Bag is ideal for trips to the target range.

Color: Black (#90231)
\$70

BENELLI GEAR

KALISPEL GUN CASE

The ultimate hard case that even knuckle-dragging luggage handlers can't destroy, the Benelli hard case is constructed from .080 aluminum and fully foam lined to hold guns in place when the four cargo-style heavy duty latches are locked into place. Lockable and airline approved, it comes with a tough canvas cover embroidered with the Benelli logo, and an accessory pouch.

Color: Black (#90402)
\$375



SPECIALTY CASES

Benelli USA GEARStore
BENELLIUSA.COM

HARD GUN CASE

Protect your Benelli shotguns with style and safety from trips to the range or field, with a durable protective carrying case. (Nova and pistol grip models do not fit in this case).

Color: Gray (#90095)
\$40



TACTICAL GUN CASE

Originally designed for military deployment and police SWAT Teams, this tactical gun case is the perfect carrying case for one of the Benelli tactical or special purpose shotguns. This black soft case is well padded, super tough and features a specially designed accessory pocket. Length: 42"

Color: Black (#90175)
\$60

GUN SOCK

Most gun cases hold in moisture, promoting rust. The Benelli Gun Sock actually lets the gun breathe and the material is impregnated with silicone to keep your gun lubricated and protected from rust.

(#90500) \$15

LEATHER SLING WITH LOGO

There is just something about fine leather that goes along with fine firearms. This sling, embossed with the Benelli logo, is made from double thickness tanned cowhide with special stitching to hold up to years of heavy use in the field. Works well on both Benelli rifles and shotguns.

(#90400) \$50

SLINGS

Benelli USA GEARStore
BENELLIUSA.COM

NEOPRENE SLING WITH LOGO

Whether you're coming back from the duck blind with a full limit of mallards or stalking elk with a Benelli R1 rifle, a sling is a really handy item. This specially designed neoprene sling quickly adapts to either a shotgun or rifle, will not slip and is impervious to moisture.

(#90401) \$25



A. and B. Protect your investment with one of our rugged traditional canvas cases. Outer shells crafted of tough canvas fabric and lined with soft, quilted cotton batting and flannel. Leather trim and solid brass hardware. Full length double zipper. Velcro®-flapped accessory pouch with elastic shell/choke tube loops. Length: 52"

Colors: Flax (#90097) or Black (#90005) \$75

C. Heavyweight cotton canvas provides superior durability and protection for both your shotgun and an extra barrel. Outer shell crafted of tough canvas fabric and lined with soft quilted cotton batting and flannel. Extra barrel pouch with embroidered Benelli logo and quick-release clasp. It features top-grain leather handle and tip. Full-length double zipper. Length: 52"

Color: Black (#90180)
\$90

D. Lightweight canvas slip cases are ideal for transporting your gun to the field while protecting it from dings and dents. Quick-release clasp and a shoulder strap for carrying ease. Length: 52"

Color: Black (#90053)
\$30

H. Intercept floating cases protect guns from the corrosive elements they're exposed to every day. High-quality dense foam padding cradles your shotgun. Embroidered accessory pocket for chokes & wrenches. Length: 52"

Color: Black (#90187) Advantage® MAX-4 HD™ (#90188) \$80



SOFT GUN CASES

Benelli USA GEARStore
BENELLIUSA.COM

E. For the utmost in protection, your shotgun deserves to be stored in one of our floating slip cases. Dense foam padding works to protect your gun and keep it afloat, should the case fall overboard. Rugged nylon canvas outer shell stays dry and resists abrasions. Velcro® closure adjusts for gun lengths up to 54". Web strap handle, shoulder strap and storage pocket with embroidered Benelli logo.

Camo pattern: Advantage® Timber HD™ (#90071) \$40

F. and I. Our zippered floating shotgun case guards your valuable Benelli from the elements. Not only does it shed water, it will float while housing a firearm. Dense closed-cell foam padding works to protect your gun and keep it afloat should the case fall overboard. Full-length zipper allows the case to be fully opened enabling it to dry after a wet hunt. Heavy-duty woven nylon canvas outer shell stays dry and resists abrasions. Length: 52"

Camo patterns: Advantage® Max-4™HD (#90072) \$45

Realtree® APG HD™ (#90186) \$45

G. For superior protection at home, in your vehicle and in the field, your R1 Rifle or Benelli slug gun needs to be stored in our Scoped Rifle Slip Case. Quick-release closure adjusts for gun lengths up to 44". Heavyweight cotton canvas provides superior durability and protection during storage or travel. It features a web strap handle, shoulder strap and storage pocket with embroidered Benelli logo. Length: 46"

Color: Black (#90185)
\$90

BENELLI GEAR

SHORT SLEEVE T-SHIRTS

This Hanes Beefy-T, emblazoned with the Benelli Tactical, or Benelli M4 logo, is constructed from 6.1-oz., 100% preshrunk cotton. It features double-needle stitched and hemmed sleeves and bottom and a double-needle stitched overseamed collar.

Tactical Color: Black, Sizes: M-XXXL Short Sleeve \$25

M4 Color: Olive, Sizes: M-XXXL Short Sleeve \$25

SPORT SHIRTS

These classically-styled sports shirts are made of 100% combed cotton, with durable double needle-construction. They feature a three-button front, rib knit collar and cuffs, and side-seam vents with a drop tail. The Benelli logo appears on the left front and left sleeve.

Colors: Ash, White, Black. Sizes: M-XL \$40
Sizes: XXL \$41

SHOOTER'S TOWEL

Absorbent hemmed terry cloth towel with embroidered Benelli logo and velcro strap that easily attaches to belt loops, sport bags or totes (no metal rings to scratch your gun)

Size: 16" X 26" (#90054) \$25



SHIRTS

Benelli USA GEARStore
BENELLIUSA.COM

Front Left Chest Logo

Front Left Chest Logo

Front Left Chest Logo

Front Left Chest Logo

ID T-SHIRTS

This Hanes Beefy-T, emblazoned with the Inertia Driven® logo, is constructed from 6.1-oz., 100% preshrunk cotton. It features double-needle stitched and hemmed sleeves and bottom and a double-needle stitched overseamed collar.

Sizes: S-XXXL Short Sleeve \$16

Sizes: S-XXXL Long Sleeve \$25

INSULATED TRAVEL TUMBLER

When headed to the range or the field you can sip your favorite drink, hot or cold, with this Benelli travel tumbler. This stainless steel tumbler has a 16-oz. capacity and features foam insulation and plastic inner liner.

(#90407) \$15



Benelli USA GEARStore
BENELLIUSA.COM

BENELLI GEAR

Benelli USA GEARStore
BENELLIUSA.COM

HATS



#90114

#90116

#90107

#90108

#90111

#90112

#90113

#90076

#90060

#90066

#90065

#90290

#90083

#90084

#90078

NEW #90119

NEW #90117

Shooting hats embroidered with Benelli logos are available in several styles and colors. One size fits all. \$20.00

SPECIFICATIONS



SUPER BLACK EAGLE II with ComforTech™

ITEM NUMBER	BARREL LENGTH	STOCK	OVERALL LENGTH	AVERAGE WEIGHT	MSRP
SUPER BLACK EAGLE II with ComforTech™ 12-GAUGE 2¾", 3" AND 3½"					
10016	28"	Synthetic	49.6"	7.3 lbs.	\$1545
10021	26"	Synthetic	47.6"	7.2 lbs.	\$1545
10026	24"	Synthetic	45.6"	7.1 lbs.	\$1545
10101	28"	Max-4 HD™ **	49.6"	7.3 lbs.	\$1665
10106	26"	Timber HD® *	47.6"	7.2 lbs.	\$1665
10108	26"	APG HD™ ***	47.6"	7.2 lbs.	\$1665
10107	26"	Max-4 HD™ **	47.6"	7.2 lbs.	\$1665
10111	24"	Timber HD® *	45.6"	7.1 lbs.	\$1665
10112	24"	APG HD™ ***	45.6"	7.1 lbs.	\$1665

SUPER BLACK EAGLE II non-ComforTech™

ITEM NUMBER	BARREL LENGTH	STOCK	OVERALL LENGTH	AVERAGE WEIGHT	MSRP
SUPER BLACK EAGLE II with Non-ComforTech™ 12-GAUGE 2¾", 3" AND 3½"					
10001	28"	Walnut	49.6"	7.3 lbs.	\$1480
10011	26"	Walnut	47.6"	7.2 lbs.	\$1480
10211	28"	Synthetic	49.6"	7.3 lbs.	\$1415
10212	26"	Synthetic	47.6"	7.2 lbs.	\$1415
10213	28"	Max-4 HD™ **	49.6"	7.3 lbs.	\$1535
10214	26"	Max-4 HD™ **	47.6"	7.2 lbs.	\$1535
10215	26"	Timber HD® *	47.6"	7.2 lbs.	\$1535
10216	24"	Timber HD® *	45.6"	7.1 lbs.	\$1535

SUPER BLACK EAGLE II with SteadyGrip™

ITEM NUMBER	BARREL LENGTH	STOCK	OVERALL LENGTH	AVERAGE WEIGHT	MSRP
10210	24"	Timber HD® *	45.6"	7.1 lbs.	\$1615
10211	24"	APG HD™ ***	45.6"	7.1 lbs.	\$1615

COMMON SPECIFICATIONS: Magazine Capacity: 3+1 Crio®Chokes: C,J,C,M,I,M,F Type of Sights: Red bar front sight and metal bead mid sight Length of Pull: 14½" Drop at heel: 2" Drop at Comb: 1½" Minimum recommended load, use 3-dram 1½ oz loads in all Benelli 12-ga. semi-auto shotguns. SBEII Rifled has a rifled bore and adj. rifled sights.



M2 FIELD with ComforTech™

ITEM NUMBER	BARREL LENGTH	STOCK	OVERALL LENGTH	AVERAGE WEIGHT	MSRP
M2 FIELD with ComforTech™ 12-GAUGE 2¾" AND 3"					
11006	28"	Synthetic	49.5"	7.2 lbs.	\$1215
11016	26"	Synthetic	47.5"	7.1 lbs.	\$1215
11021	24"	Synthetic	45.5"	7.0 lbs.	\$1215
11026	21"	Synthetic	42.5"	6.9 lbs.	\$1215
11101	28"	Max-4 HD™ **	49.5"	7.2 lbs.	\$1335
11106	26"	Timber HD® *	47.5"	7.1 lbs.	\$1335
11108	26"	APG HD™ ***	47.5"	7.1 lbs.	\$1335
11107	26"	Max-4 HD™ **	47.5"	7.1 lbs.	\$1335
11111	24"	Timber HD® *	45.5"	7.0 lbs.	\$1335
11112	24"	APG HD™ ***	45.5"	7.0 lbs.	\$1335
11116	21"	Timber HD® *	42.5"	6.9 lbs.	\$1335
11117	21"	APG HD™ ***	42.5"	6.9 lbs.	\$1335

M2 FIELD Non-ComforTech™ 12-GAUGE 2¾" AND 3"

ITEM NUMBER	BARREL LENGTH	STOCK	OVERALL LENGTH	AVERAGE WEIGHT	MSRP
11001	28"	Satin walnut	49.5"	7.2 lbs.	\$1145
11011	26"	Satin walnut	47.5"	7.1 lbs.	\$1145

COMMON SPECIFICATIONS: Magazine Capacity: 3+1 Crio®Chokes: C,J,C,M,I,M,F Type of Sights: Red bar front sight Length of Pull: 14½" Drop at heel: 2" Drop at Comb: 1½" Minimum recommended load, use 3-dram 1½ oz loads in all Benelli 12-ga. semi-auto shotguns.



M2 FIELD with ComforTech™

ITEM NUMBER	BARREL LENGTH	STOCK	OVERALL LENGTH	AVERAGE WEIGHT	MSRP
M2 FIELD 20-GAUGE 2¾" AND 3"					
11095	26"	Synthetic	47.3"	5.8 lbs.	\$1215
11097	24"	Synthetic	45.3"	5.7 lbs.	\$1215
11086	26"	Timber HD® *	47.3"	5.8 lbs.	\$1335
11085	24"	Timber HD® *	45.3"	5.7 lbs.	\$1335
11087	24"	APG HD™ ***	45.3"	5.7 lbs.	\$1335
11088	26"	APG HD™ ***	47.3"	5.8 lbs.	\$1335

COMMON SPECIFICATIONS: Magazine Capacity: 3+1 Chokes: C,J,C,M,I,M,F Type of Sights: Red bar front sight and metal bead mid sight Length of Pull: 14½" Drop at heel: 2¼" Drop at Comb: 1½" Minimum recommended load, use 2½-dram ¾ oz loads in all Benelli 20-ga. semi-auto shotguns.



CORDOBA with ComforTech™

ITEM NUMBER	BARREL LENGTH	STOCK	OVERALL LENGTH	AVERAGE WEIGHT	MSRP
CORDOBA with ComforTech™ 12-GAUGE 2¾" AND 3"					
10636	28"	Synthetic ◊	49.6"	7.2 lbs.	\$1735
10637	30"	Synthetic ◊	51.6"	7.3 lbs.	\$1735
10638	28"	Max-4 HD™ **	49.6"	7.2 lbs.	\$1865
CORDOBA with ComforTech™ 20-GAUGE 2¾" AND 3"					
10650	28"	Synthetic ◊	49.6"	6.3 lbs.	\$1735

COMMON SPECIFICATIONS: Magazine Capacity: 4+1 Extended Crio®Chokes (Black): C,J,C,M,I,M,F Type of Sights: Red bar front sight and metal bead mid sight Length of Pull: 14½" Drop at heel: 2" Drop at Comb: 1½" ◊ With GripTight™ coating, Minimum recommended load, use 3-dram 1½ oz loads in all Benelli 12-ga. semi-auto shotguns.



SUPERSPORT with ComforTech™

ITEM NUMBER	BARREL LENGTH	STOCK	OVERALL LENGTH	AVERAGE WEIGHT	MSRP
SUPERSPORT with ComforTech™ 12-GAUGE 2¾" AND 3"					
10630	28"	Carbon Fiber	49.6"	7.2 lbs.	\$1800
10635	30"	Carbon Fiber	51.6"	7.3 lbs.	\$1800
SUPERSPORT with ComforTech™ 20-GAUGE 2¾" AND 3"					
10655	28"	Carbon Fiber	49.6"	6.3 lbs.	\$1800

COMMON SPECIFICATIONS: Magazine Capacity: 4+1 Extended Crio®Chokes (Chrome): C,J,C,M,I,M,F Type of Sights: Red bar front sight and metal bead mid sight Length of Pull: 14½" Drop at heel: 2" Drop at Comb: 1½"



SPORT II

ITEM NUMBER	BARREL LENGTH	STOCK	OVERALL LENGTH	AVERAGE WEIGHT	MSRP
SPORT II 12-GAUGE 2¾" AND 3"					
10620	28"	A-Grade	49.5"	7.2 lbs.	\$1580
10625	30"	A-Grade	51.6"	7.3 lbs.	\$1580
SPORT II 20-GAUGE 2¾" AND 3"					
10670	28"	A-Grade	49.5"	6.3 lbs.	\$1580

COMMON SPECIFICATIONS: Magazine Capacity: 4+1 Extended Crio®Chokes (Chrome): C,J,C,M,I,M,F TYPE OF SIGHTS: Red bar front sight and metal bead mid sight Length of Pull: 14½" Drop at heel: 2¼" Drop at Comb: 1½"

*Advantage Timber HD® **Advantage® Max-4 HD™ ***Realtree® APG HD™



LEGACY

ITEM NUMBER	BARREL LENGTH	STOCK	OVERALL LENGTH	AVERAGE WEIGHT	MSRP
LEGACY Acid etched game scenes 12-GAUGE 2¾" AND 3"					
10400	28"	AA-Grade	49.5"	7.4 lbs.	\$1565
10405	26"	AA-Grade	47.5"	7.3 lbs.	\$1565
LEGACY Acid etched game scenes 20-GAUGE 2¾" AND 3"					
10420	26"	AA-Grade	47.3"	6.0 lbs.	\$1565
10425	24"	AA-Grade	45.3"	5.8 lbs.	\$1565

COMMON SPECIFICATIONS: Magazine Capacity: 4+1 Chokes: C,J,C,M,I,M,F Type of Sights: Red bar front sight and metal bead mid sight Length of Pull: 14½" Drop at heel: 2¼" Drop at Comb: 1½" Minimum recommended load, use 3-dram 1½ oz loads in all Benelli 12-ga. semi-auto shotguns.



ULTRALIGHT

ITEM NUMBER	BARREL LENGTH	STOCK	OVERALL LENGTH	AVERAGE WEIGHT	MSRP
ULTRALIGHT 12-GAUGE 2¾" AND 3"					
10801	24"	WeatherCoat™	45.5"	6.0 lbs.	\$1385
10802	26"	WeatherCoat™	47.5"	6.1 lbs.	\$1385

COMMON SPECIFICATIONS: Magazine Capacity: 2+1 Crio®Chokes: I,C,M,F Type of Sights: Red bar front sight and metal bead mid sight Length of Pull: 14½" Drop at heel: 2¼" Drop at Comb: 1½" Minimum recommended load, use 3-dram 1½ oz loads in all Benelli 12-ga. semi-auto shotguns.



MONTEFELTRO

ITEM NUMBER	BARREL LENGTH	STOCK	OVERALL LENGTH	AVERAGE WEIGHT	MSRP
MONTEFELTRO 12-GAUGE 2¾" AND 3"					
10800	28"	Walnut	49.5"	7.1 lbs.	\$1110
10810	26"	Walnut	47.5"	6.9 lbs.	\$1110
10820	24"	Walnut	45.5"	6.8 lbs.	\$1110
MONTEFELTRO 20-GAUGE 2¾" AND 3"					
10830	26"	Walnut	47.5"	5.6 lbs.	\$1110
10835	24"	Walnut	45.5"	5.5 lbs.	\$1110
MONTEFELTRO SHORT STOCK 20-GAUGE 2¾" AND 3"					
10831	26"	Walnut	45.6"	5.4 lbs.	\$1120
10836	24"	Walnut	43.6"	5.3 lbs.	\$1120

MONTEFELTRO SILVER 12-GAUGE 2¾" AND 3"

10850	28"	AA-Grade	49.5"	7.1 lbs.	\$1535
-------	-----	----------	-------	----------	--------

MONTEFELTRO SILVER 20-GAUGE 2¾" AND 3"

10855	26"	AA-Grade	47.5"	5.4 lbs.	\$1535
-------	-----	----------	-------	----------	--------

COMMON SPECIFICATIONS: Magazine Capacity: 4+1 Chokes: C,J,C,M,I,M,F Type of Sights: Red bar front sight Length of Pull: 14½", (Short Stock 12½") Drop at heel: 2¼", (Short Stock: 2¼") Drop at Comb: 1½" Minimum recommended load, use 3-dram 1½ oz loads in all Benelli 12-ga. semi-auto shotguns.

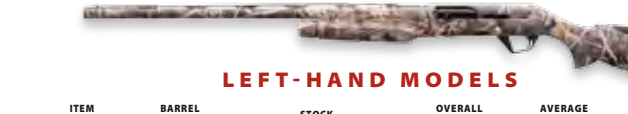

LEFT-HAND MODELS

ITEM NUMBER	BARREL LENGTH	STOCK	OVERALL LENGTH	AVERAGE WEIGHT	MSRP
SUPER BLACK EAGLE II with ComforTech™ 12-GAUGE 2¾", 3" AND 3½"					
10066	24"	Synthetic	45.6"	7.1 lbs.	\$1580
10071	26"	Synthetic	47.6"	7.2 lbs.	\$1580
10076	28"	Synthetic	49.6"	7.3 lbs.	\$1580
10116	28"	Max-4 HD™ **	49.6"	7.3 lbs.	\$1700
10121	28"	Timber HD® *	49.6"	7.3 lbs.	\$1700
10122	26"	APG HD™ ***	47.6"	7.2 lbs.	\$1700
10126	24"	Timber HD® *	45.6"	7.1 lbs.	\$1700
10127	24"	APG HD™ ***	45.6"	7.1 lbs.	\$1700

continued next column

LEFT-HAND MODELS (Continued)

ITEM NUMBER	BARREL LENGTH	STOCK	OVERALL LENGTH	AVERAGE WEIGHT	MSRP
M2 FIELD with ComforTech™ 12-GAUGE 2¾" AND 3"					
11071	28"	Synthetic	49.5"	7.2 lbs.	\$1245
11073	26"	Synthetic	47.5"	7.1 lbs.	\$1245
11075	24"	Synthetic	45.5"	7.0 lbs.	\$1245
11121	28"	Max-4 HD™ **	49.5"	7.2 lbs.	\$1365
11126	26"	APG HD™ ***	47.5"	7.1 lbs.	\$1365
11127	26"	Timber HD® *	47.5"	7.1 lbs.	\$1365
11131	24"	APG HD™ ***	45.5"	7.0 lbs.	\$1365
11132	24"	Timber HD® *	45.5"	7.0 lbs.	\$1365

MONTEFELTRO 12-GAUGE 2¾" AND 3"

10805	28"	Satin walnut	49.5"	7.1 lbs.	\$1120
10815	26"	Satin walnut	47.5"	6.9 lbs.	\$1120

COMMON SPECIFICATIONS: Magazine Capacity: 3+1 (Montefeltro: 4+1) Chokes: C,J,C,M,I,M,F (SBEII and M2 Field: Crio®Chokes.) Type of Sights: Red bar front sight Length of Pull: 14½" Drop at heel: 2" (Montefeltro 2¾") Drop at Comb: 1½" (Montefeltro 1½")



SUPERNOVA

ITEM NUMBER	BARREL LENGTH	STOCK	TYPE OF SIGHTS	OVERALL LENGTH	AVERAGE WEIGHT	MSRP
SUPERNOVA with ComforTech™ 12-GAUGE 2¾", 3" AND 3½"						
20100	28"	Synthetic	Red bar†	49.5"	8.0 lbs.	\$455
20105	26"	Synthetic	Red bar†	47.5"	7.9 lbs.	\$455
20110	24"	Synthetic	Red bar†	45.5"	7.8 lbs.	\$455
20115	28"	Max-4 HD™ **	Red bar†	49.5"	8.0 lbs.	\$545
20120	26"	Max-4 HD™ **	Red bar†	47.5"	7.9 lbs.	\$545
20125	26"	Timber HD® *	Red bar†	47.5"	7.9 lbs.	\$545
20126	26"	APG HD™ ***	Red bar†	47.5"	7.9 lbs.	\$545
20130	24"	Timber HD® *	Red bar†	45.5"	7.8 lbs.	\$545
20131	24"	APG HD™ ***	Red bar†	45.5"	7.8 lbs.	\$545

SUPERNOVA SteadyGrip™ 12-GAUGE 2¾", 3" AND 3½"

20135	24"	Timber HD® *	Red bar†	45.5"	7.9 lbs.	\$560
20136	24"	APG HD™ ***	Red bar†	45.5"	7.9 lbs.	\$560
20140	24"	Synthetic	Red bar†	45.5"	7.9 lbs.	\$465

SUPERNOVA Tactical 12-GAUGE 2¾", 3" AND 3½"

20145	18"	ComforTech™	Open rifle	40.0"	7.2 lbs.	\$400
20150	18"	Pistol Grip	Open rifle	40.0"	7.2 lbs.	\$415
20155	18"	ComforTech™	Ghost ring	40.0"	7.2 lbs.	\$425
20160						

SPECIFICATIONS



NOVA PUMP (Continued)

ITEM NUMBER	BARREL LENGTH	STOCK	OVERALL LENGTH	AVERAGE WEIGHT	MSRP
<i>NOVA Slug and Field combo</i>					
20099	26"/24"	Synthetic	47.5"/45.5"	7.9/8.1 lbs.	\$560
NOVA PUMP 20-GAUGE 2 3/4" AND 3"					
20030	26"	Synthetic	47.5"	6.6 lbs.	\$360
20035	24"	Synthetic	45.5"	6.5 lbs.	\$360
20040	26"	Timber HD* **	47.5"	6.6 lbs.	\$455
20041	26"	APG HD™ ***	47.5"	6.6 lbs.	\$455
20045	24"	Timber HD* **	45.5"	6.5 lbs.	\$455
20047	24"	APG HD™ ***	45.5"	6.5 lbs.	\$455
NOVA PUMP YOUTH 20-GAUGE 2 3/4" AND 3"					
20036	24"	Synthetic	44.2"	6.4 lbs.	\$375
20046	24"	Timber HD* **	44.2"	6.4 lbs.	\$465
20048	24"	APG HD™ ***	44.2"	6.4 lbs.	\$465

COMMON SPECIFICATIONS: Magazine Capacity: 4+1 Chokes: IC,M,F Type of Sights: Red bar front sight and metal bead mid sight Length of Pull: 14 1/4" (Youth: 13") Drop at heel: 2" (Youth: 2") Drop at Comb: 1 1/8" Recoil Reducer fits 12-ga. synthetic field stocks only. Nova Pump Slug has a rifled bore.



RIFLED SLUG GUNS

ITEM NUMBER	BARREL LENGTH	STOCK	OVERALL LENGTH	AVERAGE WEIGHT	MSRP
SUPER BLACK EAGLE II RIFLED SLUG † with ComforTech™ 12-GAUGE 2 3/4" AND 3"					
10036	24"	Synthetic	45.6"	7.4 lbs.	\$1615
10131	24"	Timber HD* **	45.6"	7.4 lbs.	\$1735
10132	24"	APG HD™ ***	45.6"	7.4 lbs.	\$1735
M2 FIELD RIFLED SLUG † with ComforTech™ 12-GAUGE 2 3/4" AND 3"					
11061	24"	Synthetic	45.5"	7.3 lbs.	\$1280
11141	24"	Timber HD* **	45.5"	7.3 lbs.	\$1400
11142	24"	APG HD™ ***	45.5"	7.3 lbs.	\$1400
SUPERNOVA SLUG † 12-GAUGE 2 3/4" AND 3"					
20143	24"	Synthetic	45.5"	8 lbs.	\$645
20144	24"	APG HD™ ***	45.5"	8 lbs.	\$725
SUPERNOVA FIELD AND SLUG COMBO ‡ with ComforTech™ 12-GAUGE 2 3/4" AND 3"					
20106	26"/24"	Synthetic	47.5"/45.5"	7.9/8 lbs.	\$655
NOVA FIELD AND SLUG COMBO ‡ 12-GAUGE 2 3/4" AND 3"					
20099	26"/24"	Synthetic	47.5"/45.5"	7.9/8.1 lbs.	\$560
M2 FIELD SLUG † with ComforTech™ 20-GAUGE 2 3/4" AND 3"					
11093	24"	Synthetic	45.3"	6.5 lbs.	\$1280
11089	24"	APG HD™ ***	45.3"	6.5 lbs.	\$1400
NOVA PUMP SLUG † 20-GAUGE 2 3/4" AND 3"					
20031	24"	Synthetic	45.5"	6.7 lbs.	\$560
20082	24"	Timber HD* **	45.5"	6.7 lbs.	\$640

COMMON SPECIFICATIONS: Magazine Capacity: 3+1 (SuperNova and Nova Pump: 4+1) Chokes: Rifled Bore Type of Sights: Adj. Rifle (Nova Field and Slug Combo: Red bar front sight and metal bead mid sight and Cantilever barrel) Length of Pull: 14 3/4" (SuperNova and Nova Pump: 14 1/4") Drop at heel: 2 1/4" (SBEII: 2") Drop at Comb: 1 1/8" † Receiver is drilled and tapped for scope mounting. ‡ Red bar front sight and metal bead mid sight.



TURKEY GUNS with ComforTech™

ITEM NUMBER	BARREL LENGTH	STOCK	OVERALL LENGTH	AVERAGE WEIGHT	MSRP
M2 FIELD 12-GAUGE 2 3/4" AND 3"					
11111	24"	Timber HD* **	45.5"	7.0 lbs.	\$1335
11112	24"	APG HD™ ***	45.5"	7.0 lbs.	\$1335
11116	21"	Timber HD* **	42.5"	6.9 lbs.	\$1335
11117	21"	APG HD™ ***	42.5"	6.9 lbs.	\$1335
M2 FIELD LEFT HAND 12-GAUGE 2 3/4" AND 3"					
11131	24"	Timber HD* **	45.5"	7.0 lbs.	\$1365
11132	24"	APG HD™ ***	45.5"	7.0 lbs.	\$1365
M2 FIELD 20-GAUGE 2 3/4" AND 3"					
11085	24"	Timber HD* **	45.3"	5.7 lbs.	\$1335
SUPER BLACK EAGLE II† 12-GAUGE 2 3/4" AND 3"					
10111	24"	Timber HD* **	45.6"	7.1 lbs.	\$1665
10112	24"	APG HD™ ***	45.6"	7.1 lbs.	\$1665
SUPER BLACK EAGLE II LEFT-HAND† 12-GAUGE 2 3/4" AND 3"					
10126	24"	Timber HD* **	45.5"	7.1 lbs.	\$1700
10127	24"	APG HD™ ***	45.5"	7.1 lbs.	\$1700

COMMON SPECIFICATIONS: Magazine Capacity: 3+1 Crio*Chokes: C,IC,M,IM,F Type of Sights: Red bar front sight and metal bead mid sight Length of Pull: 14 3/4" Drop at heel: 2" Drop at Comb: 1 1/8" † Receiver is drilled and tapped for scope mounting.



TURKEY GUNS

ITEM NUMBER	BARREL LENGTH	MAGAZINE CAPACITY	STOCK	OVERALL LENGTH	AVERAGE WEIGHT	MSRP
SUPER BLACK EAGLE II**† Δ with Non-ComforTech™ 12-GAUGE 2 3/4", 3" AND 3 1/2"						
10216	24"	3+1	Timber HD* **	45.6"	7.1 lbs.	\$1535
NOVA PUMP ΔΔ 12-GAUGE 2 3/4", 3" AND 3 1/2"						
20080	24"	4+1	Timber HD* **	45.5"	7.8 lbs.	\$455
20087	24"	4+1	APG HD™ ***	45.5"	7.8 lbs.	\$455
NOVA PUMP** ΔΔ 20-GAUGE 2 3/4", 3"						
20045	24"	4+1	Timber HD* **	45.5"	6.5 lbs.	\$455
M2 FIELD with SteadyGrip™ † Δ 12-GAUGE 2 3/4" AND 3"						
11051	24"	3+1	Timber HD* **	45.5"	7.2 lbs.	\$1375
11052	24"	3+1	APG HD™ ***	45.5"	7.2 lbs.	\$1375
SUPER BLACK EAGLE II with SteadyGrip™ † Δ 12-GAUGE 2 3/4", 3" AND 3 1/2"						
10210	24"	3+1	Timber HD* **	45.6"	7.3 lbs.	\$1615
10211	24"	3+1	APG HD™ ***	45.6"	7.3 lbs.	\$1615
SUPERNOVA with SteadyGrip™ † ΔΔ 12-GAUGE 2 3/4", 3" AND 3 1/2"						
20135	24"	4+1	Timber HD* **	47.5"	7.9 lbs.	\$560
20136	24"	4+1	APG HD™ ***	47.5"	7.9 lbs.	\$560

COMMON SPECIFICATIONS: Type of Sights: Red bar front sight and metal bead mid sight Length of Pull: 14 1/4" (SBEII and M2 Field: 14 3/4") Drop at heel: 2 1/4" (SBEII: 2") Drop at Comb: 1 1/8" † Receiver is drilled and tapped for scope mounting. Δ Crio*Chokes: C, IC, M, IM, F ΔΔ Chokes: IC, M, F

Advantage Timber HD **Advantage* Max-4 HD™ ***Realtree* APG HD™



M4 TACTICAL

ITEM NUMBER	BARREL LENGTH	STOCK	OVERALL LENGTH	AVERAGE WEIGHT	MSRP
M4 TACTICAL 12-GAUGE 2 3/4" AND 3"					
11707	18.5"	Pistol Grip/Synthetic	40.0"	7.8 lbs.	\$1600
11717	18.5"	Pistol Grip/Desert Camo	40.0"	7.8 lbs.	\$1735

COMMON SPECIFICATIONS: Magazine Capacity: 4+1 Chokes: C Type of Sights: Ghost Ring Length of Pull: 14 3/8" Drop at heel: 2 1/4" Drop at Comb: 1 1/8" Receiver is drilled and tapped for scope mount. Picatinny rail is included.



SUPERNOVA TACTICAL

ITEM NUMBER	BARREL LENGTH	STOCK	TYPE OF SIGHTS	OVERALL LENGTH	AVERAGE WEIGHT	MSRP
SUPERNOVA TACTICAL 12-GAUGE 2 3/4", 3" AND 3 1/2"						
20145	18"	Comfort Tech™	Rifle	40.0"	7.8 lbs.	\$415
20150	18"	Pistol Grip	Rifle	40.0"	7.8 lbs.	\$425
20155	18"	Comfort Tech™	Ghost-ring	40.0"	7.8 lbs.	\$440
20160	18"	Pistol Grip	Ghost-ring	40.0"	7.8 lbs.	\$455
20161	18"	Pistol Grip/Desert Camo	Ghost-ring	40.0"	7.8 lbs.	\$545

COMMON SPECIFICATIONS: Magazine Capacity: 4+1 Chokes: Fixed Cyl Length of Pull: 14 3/8" Drop at heel: 2" Drop at Comb: 1 1/8" Receiver is drilled and tapped for scope mount. Picatinny rail is included.



DEFENSE

ITEM NUMBER	BARREL LENGTH	STOCK	TYPE OF SIGHTS	OVERALL LENGTH	AVERAGE WEIGHT	MSRP
M2 TACTICAL 12-GAUGE 2 3/4" AND 3"						
11052	18.5"	Pistol Grip	Ghost-ring	39.75"	6.7 lbs.	\$1175
11053	18.5"	Synthetic	Ghost-ring	39.75"	6.7 lbs.	\$1175
11054	18.5"	Pistol Grip	Open rifle	39.75"	6.7 lbs.	\$1065
11055	18.5"	Synthetic	Open rifle	39.75"	6.7 lbs.	\$1065
11027	18.5"	ComforTech™	Open rifle	39.75"	6.7 lbs.	\$1175
11029	18.5"	ComforTech™	Ghost-ring	39.75"	6.7 lbs.	\$1280
NOVA PUMP TACTICAL 12-GAUGE 2 3/4", 3" AND 3 1/2"						
20050	18.5"	Synthetic	Open rifle	40.0"	7.2 lbs.	\$340
20051	18.5"	Synthetic	Ghost-ring	40.0"	7.2 lbs.	\$375

COMMON SPECIFICATIONS: Magazine Capacity: 5+1, (Nova Pump: 4+1), M2 w/ComforTech™: 3+1) Chokes: IC, M, F Crio*Chokes (Nova Pump: Fixed Cyl) Length of Pull: 14 3/4" (Nova Pump: 14 1/4") Drop at heel: 2" (Nova Pump: 2 1/4") Drop at Comb: 1 1/8" (Nova Pump: 1 1/4")



DEFENSE

ITEM NUMBER	BARREL LENGTH	STOCK	TYPE OF SIGHTS	OVERALL LENGTH	AVERAGE WEIGHT	MSRP
NOVA PUMP H2O 12-GAUGE 2 3/4", 3" AND 3 1/2"						
20090	18.5"	Synthetic	Open rifle	40.0"	7.2 lbs.	\$535
M3 CONVERTIBLE PUMP/AUTO 12-GAUGE 2 3/4" AND 3"						
11600	19.75"	Synthetic	Open rifle	45.6"	7.2 lbs.	\$1255
11601	19.75"	Pistol Grip	Open rifle	45.6"	7.2 lbs.	\$1255
11605	19.75"	Synthetic	Ghost-ring	45.6"	7.2 lbs.	\$1335
11606	19.75"	Pistol Grip	Ghost-ring	45.6"	7.2 lbs.	\$1335

COMMON SPECIFICATIONS: Magazine Capacity: 5+1 (Nova Pump: 4+1) Length of Pull: 14 3/4" (Nova Pump: 14 1/4") Drop at heel: 2" (Nova Pump: 2 1/4") Drop at Comb: 1 1/8" (Nova Pump: 1 1/4")



R1 RIFLE with ComforTech™

ITEM NUMBER	BARREL LENGTH	STOCK	MAGAZINE CAPACITY	OVERALL LENGTH	AVERAGE WEIGHT	MSRP
R1 .30-06 SPRINGFIELD						
11753	22"	Synthetic	4+1	44"	7.2 lbs.	\$1435
11755	22"	APG HD™ ***	4+1	44"	7.2 lbs.	\$1565
R1 .300 WIN MAG						
11750	24"	Synthetic	3+1	46"	7.3 lbs.	\$1435
R1 300 WSM						
11751	24"	Synthetic	3+1	46"	7.3 lbs.	\$1435
R1 270 WSM						
11752	24"	Synthetic	3+1	46"	7.3 lbs.	\$1435

COMMON SPECIFICATIONS: Stock: Synthetic ComforTech™ Twist Rate: 1:11" Type of Sights: Receiver is drilled and tapped for scope mount. Picatinny rail is included. Open sights are available for purchase. Length of Pull: 14" Drop at heel: 1 3/4" Drop at Comb: 1 1/4"



R1 RIFLE

ITEM NUMBER	BARREL LENGTH	STOCK	MAGAZINE CAPACITY	OVERALL LENGTH	AVERAGE WEIGHT	MSRP
R1 .30-06 SPRINGFIELD						
11735	20"	Walnut	4+1	41.75"	7.0 lbs.	\$1265
11736	22"	Walnut	4+1	43.75"	7.1 lbs.	\$1265
R1 .308 WIN						
11745	22"	Walnut	4+1	43.75"	7.1 lbs.	\$1265
R1 .300 WIN MAG						
11731	24"	Walnut	3+1	45.75"	7.2 lbs.	\$1265
11730	20"	Walnut	3+1	41.75"	7.1 lbs.	\$1265
R1 .300 WSM						
11749	24"	Walnut	3+1	45.75"	7.2 lbs.	\$1265
R1 .270 WSM						
11748	24"	Walnut	3+1	45.75"	7.2 lbs.	\$1265

COMMON SPECIFICATIONS: Type of Sights: Receiver is drilled and tapped for scope mount. Picatinny rail is included. Open sights are available for purchase. Length of Pull: 13 1/4" Drop at heel: 1 3/4" Drop at Comb: 1 1/4"



TOM KNAPP'S BENELLI M1 SUPER 90



M1 SUPER 90 — 12-GA.
Synthetic

Tom Knapp finally retired his old Benelli M1 Super 90 last year when he donated it to the Buffalo Bill Historic Center in Cody, Wyoming, where it will be put on permanent display next to the guns of other great exhibition shooters like Herb Parsons and Annie Oakley. Tom's old Benelli wasn't worn out, in fact it had never let Tom down. After Tom had presented his faithful Super 90 to the museum, he sat down to figure out just how many rounds he had fired through that gun. With over 100 live shows per year, the total number of rounds put through the Benelli was over half a million.

Well, it's a good thing Tom decided to retire that gun, because at that pace he might have worn it out ... in another hundred years or so.

TOM KNAPP



As host for Benelli's American Bird Hunter TV show, Tom Knapp travels to some of the world's finest bird shooting destinations to bring viewers the best in hunting, shooting and outdoor entertainment. Catch Tom's show on the Outdoor Channel."

Tom Knapp is recognized as the greatest exhibition shooter of modern times. With TV appearances and more than 140 live shows a year in the United States and Europe, Tom has thrilled countless spectators with his seemingly impossible feats with shotguns. Of course the shotguns that Tom shoots are Benellis.

The holder of two World Records for hand thrown clay targets — 9 clays with a Benelli M1 Super 90 in 1993 and 8 clays with a Benelli Nova Pump in 2000, Tom set out to do it again. On October 20th, 2004 in Murfreesboro, Tennessee, he did the unbelievable, shooting 10 clay targets out of the air in 2.2 seconds with a Benelli M2 Field with ComforTech™. Interviewed on the Shooting USA TV show that witnessed the World Record breaking event, Tom commented, "hard work and commitment are two key elements, but without the right equipment I could never do it. That's why I shoot Benellis."

We congratulate Tom Knapp on his third World Record and thank him for being one of the finest ambassadors that American shooting sports has ever known. We're proud of Tom and we're proud that Tom shoots Benellis. Three World Records, three Benelli shotguns and Tom Knapp high-over-all ... now that's a winning hand you can't beat.



WORLD RECORD NO. 1

Tom joined Benelli in 1993 when he set the world record with his Benelli M1 Super 90 by throwing nine standard clay targets and breaking them with individual shots in 2.3 seconds.

WORLD RECORD NO. 2

On July 19, 2000 Tom Knapp, with his Benelli Nova pump in one hand, threw eight clay targets in the air with his other hand and broke everyone of them with individual shots in an amazing 2.1 seconds.

World Record No. 3

In Murfreesboro, Tennessee, on October 20th, 2004 Tom Knapp set out to make history again. With his 12-ga. Benelli M2 fitted with a ComforTech™ stock and extended magazine tube, Tom launched ten clay targets into the air with one hand, shooting all ten with individual shots in an unbelievable 2.2 seconds.

TIM BRADLEY



Tim Bradley joins Team Benelli as our Newest Exhibition Shooter.

Tim Bradley learned to shoot at an early age. Growing up on his family's farm in northeast Arkansas, he shot almost everyday, devoting every spare minute to hunting, trapping and shooting—often burning up five or six cases of .22 ammunition each year. During his high school years Bradley became interested in boxing and the martial arts, earning his black belt in karate by the age of 17.

Utilizing the discipline he learned from the martial arts and his ability for mastering extreme challenges, Bradley tackled the unique and difficult requirements of becoming a world-class exhibition shooter. He honed his gun handling skills through years of practice and by firing thousands upon thousands of rounds of ammo. Bradley's talents were recognized by none other than Tom Knapp, Team Benelli USA's World Record holding exhibition shooter. Determination and dedication to perfect specific shooting skills finally paid off for Bradley, who was invited to join Team Benelli's busy shooting exhibition schedule, teaming up with Tom Knapp in 2006 to thrill crowds of all ages all across the country.