



DIE MEISTER MACHER

The Line of
HUNTING, SPORTING AND CUSTOM GRADE RIFLES



OUR EXPERIENCE AND PASSION MAKE US PRODUCE A HIGH LEVEL OF QUALITY

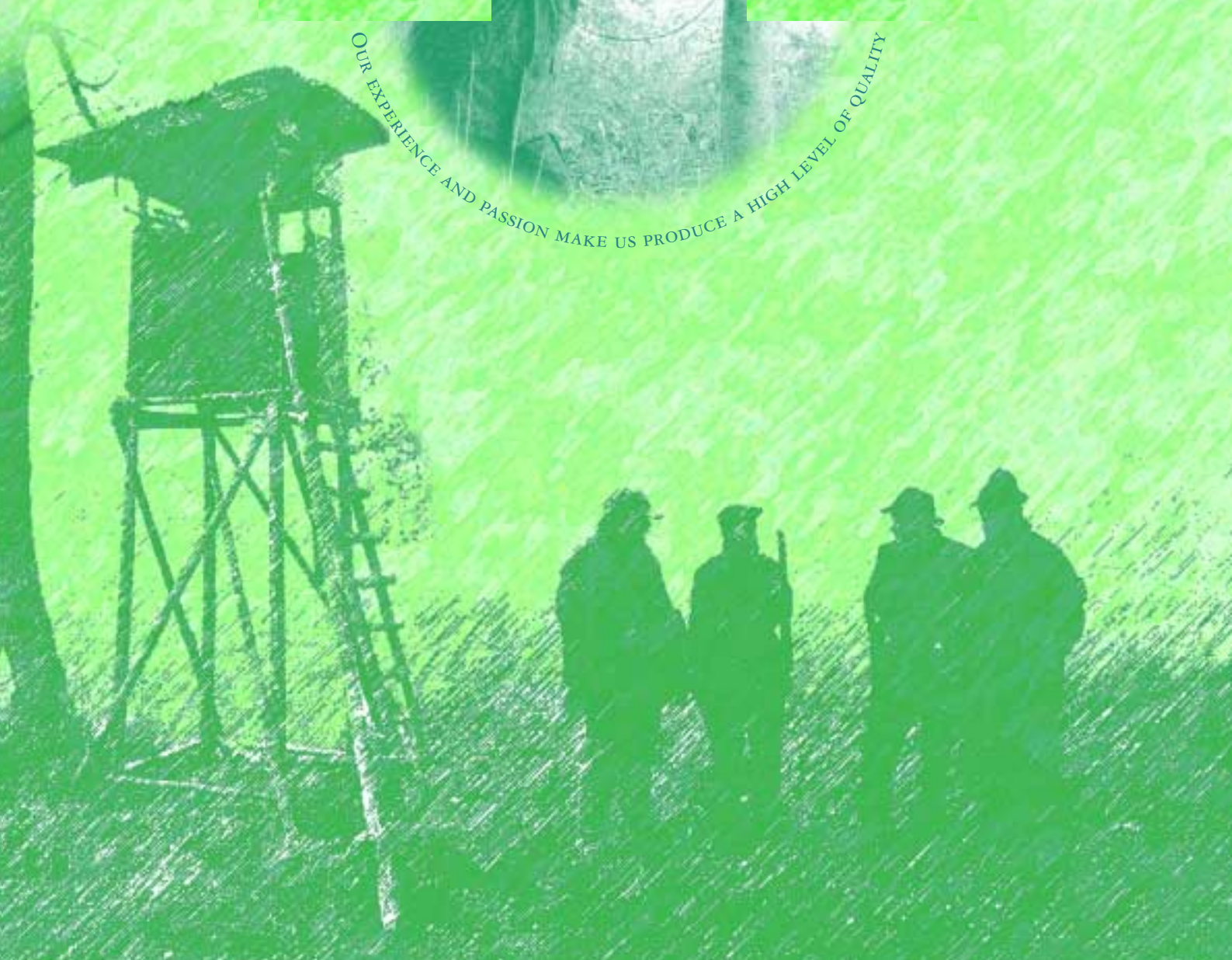

Match 64

Match 54



Trigger Chart

TRIGGER CHART

Item No.	Model	Two stage trigger	Single stage trigger	Double set trigger	Adjusted to	Right hand version	Left hand version	For Models
003793	5001			•	100 g	•		1416 ST, 1516 ST
003799	5004			•	100 g	•		1710 ST, 1730 ST, 1740 ST
003136	5007			•	100 g	•		1432 E ST 1740 E ST
003886	5067/2		•		1.360 g	•		1451 D
700.6565	5073	•			200 g	•		1432 E 1740 E
003988	5092	•			800 g	•		1416, 1417, 1516 64 MP R, 64 P, 64 R
003989	5092 L	•			800 g		•	64L MP R, 64L P, 17L P 1416L, 1417L
003992	5094		•		1.200 g	•		1416 D, 1502 D, 1516 D 1517 D, 1518 D
003996	5094 L		•		1.200 g		•	1416L D, 1517L D
003998	5095		•		1.300 g	•		1740 D
004007	5096 D		•		1.200 g	•		1702 D, 1710 D, 1712 D, 1717 D, 1720 D, 1730 D
002144	5103	•			1.500 g	•		64 MS R, 64 R Biathlon
002145	5103 L	•			1.500 g		•	64L MS R, 64L R Biathlon
007540	5106	•			700 g	•		1517 MP R
007679	5108	•			1.000 g	•		1710
007692	5109	•			1.000 g	•		1712
002800	5165		•		2.000 g	•		1365
002771	5175		•		1.500 g	•		525

Symbol Description

SYMBOL DESCRIPTION

Symbols for the referring application:

The ANSCHÜTZ MISSION symbols show you at once for which application the illustrated rifles are especially suitable.



ANSCHÜTZ Mission 1:
For sports, leisure time and competition.



ANSCHÜTZ Mission 2:
For varmint control or for hunting small animals.



ANSCHÜTZ Mission 3:
For hunting small game and small predator.



ANSCHÜTZ Mission 4:
For hunting hoofed game.

Special criteria of quality:

These symbols show you additional advantages of the illustrated rifles.



Special version for left hand shooters:
These rifles are also available for left hand shooters.

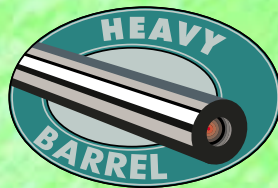

Heavy barrel:
These rifles are equipped with a heavy barrel produced in a special ANSCHÜTZ manufacturing process.



The "high level of quality" symbol:

This symbol draws your attention to special passages in the text which explain outstanding quality characteristics of the ANSCHÜTZ products to you. You will esteem these advantages when shooting your ANSCHÜTZ rifle or pistol.

Legend for ANSCHÜTZ Hunting, Sporting and Custom Grade Rifles:

D = Single stage trigger	wos. = Without sights
E = Single loader	R = Repeater
G = Barrel thread	Silh. = Silhouette
HB = Heavy barrel	ST = Double set trigger
KL = Folding leaf sight	* = As long as available
L = Left hand version	
MP = Multi Purpose	

CHARTS, TRIGGERS AND SYMBOL DESCRIPTION Folding page 3 - 4

INTRODUCTION AND HISTORY 6 - 7

VALUABLE INFORMATION 8 - 11

Triggers, barrels and sights 8

Stock types 9

Barreled actions 10 - 11

ANSCHÜTZ MODELS 12 - 27

Repeaters of the series 1416, Match 64 action 12 - 13

Repeaters of the series 1502 / 1516 / 1517, Match 64 action 14 - 15

Small bore hunting match repeaters of the series 64, Match 64 action 16 - 17

Hunting repeaters of the series 1700, Match 54 action 18 - 21

Competition hunting single loaders, Match 54 action 22 - 23

Semi automatic rifles of the series 525, blowback action 24 - 25

Garden shotgun 1365 26

ACCESSORIES 28 - 36

Individual special versions 28 - 29

Masterly hand engravings 29

Accessories 30 - 36

INDEX Folding page 37

MODEL AND ORDER CHARTS Folding page 38

Introduction

INTRODUCTION

Dear hunter,



This is our catalogue of hunting, sporting and custom grade rifles, which we carefully composed for you. We are pleased that you are interested in our products. This catalogue gives you a detailed overview on our line of hunting, sporting and custom grade rifles of the

famous factory of the ANSCHÜTZ Meistermacher.

your reliable companion with unsurpassed accuracy and functionality. This is why this catalogue is trend-setting.

And now have fun with our hunting catalogue.

Good hunting!

Yours



Hunting and sporting rifles must be reliable, especially with regard to a permanently excellent shooting performance. ANSCHÜTZ barrels as well as a detailed action design as offered in the famous ANSCHÜTZ target actions guarantee optimum gunsmith quality. The „Meistermacher“ have more than 150 years experience in the manufacture of high accuracy hunting and sporting rifles. Tradition, however, is just one aspect. The hunters of today demand state-of-the-art firearm technology starting from the light weight sporting rifle up to a perfect custom grade hunting rifle. With an ANSCHÜTZ rifle you are always equipped at its best. You can rely on first class ANSCHÜTZ quality. Your ANSCHÜTZ rifle will always be

Jochen Anschütz
Jochen Anschütz
President

ANSCHÜTZ
®

DIE MEISTER MACHER



The History

THE HISTORY

1856



The son of the gunsmith Johann Heinrich Gottlieb Anschütz, **Julius Gottfried Anschütz** and his wife **Luise Anschütz** founded the company J. G. Anschütz in Mehlis, Thuringia, for the manufacture of Flobert and pocket pistols, Teschings, shotguns and Lancaster Terzerole.



1950

A new beginning in Ulm. The company J. G. ANSCHÜTZ GmbH is founded. The company has 7 employees and 20 machines. In the beginning they make air pistols and carry out repair works, then they start to manufacture Flobert and target rifles. Soon the company has 250 employees. The first target shooting successes come in. Then everything goes very fast.



1968

Dieter Anschütz, representing the 4th generation takes over the management of the company and he continues to this day with all his knowledge, competence and personal engagement.



ANSCHÜTZ factory in Ulm, Germany.

1972



ANSCHÜTZ factory in 1900.

After the overwhelming success of the ANSCHÜTZ match barreled action the slogan „ANSCHÜTZ makes Champions“ („Die Meistermacher“) was created and it is still valid.



1992

Jochen Anschütz becomes president of the company and is now leading it together with his father Dieter Anschütz.



ANSCHÜTZ factory in 1909.



Valuable Information

Triggers:

ANSCHÜTZ match two stage triggers and single stage triggers have always been trend-setting with regard to quality, reliability and accuracy. This is why they are the best worldwide.

Many manufacturers offer adaptations to their rifles to make an integration of this master piece of German gunsmith technology possible. The low-weight, hardened and finely polished triggers enable a fast and precise release of the trigger.

Depending on the model two stage triggers, D = single stage triggers or ST = double set triggers are available. Please also see the trigger chart on folding page 3.



Two stage trigger 5109.



Two stage trigger 5108.



Single stage trigger 5096.



Two stage trigger 5073.



Double set trigger 5007.



Single stage trigger 5094.



Barrels:

The barrels are manufactured using the same special process perfected for the ANSCHÜTZ target rifles. The same attention to detail is given to the fitting of the receiver and the counterbore at the muzzle.



We also offer the popular heavy ANSCHÜTZ barrels for some of our models. We have marked this on our order card. The advantage of these barrels is the increased weight, which improves stability in position.

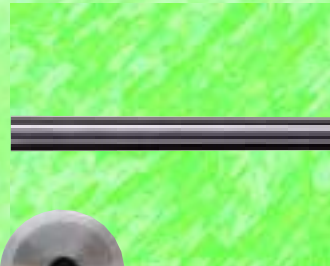

11° Muzzle.



G = Barrel thread, e. g. for model 525 KL G.

Sights:

KL = Folding leaf sight:

The folding leaf sight adjustable in height is usually delivered together with a pearl front sight adjustable in height on ramp with hood.



KL = Folding leaf sight.

Blueing:

The first corrosion protection the gun manufacturers used was bronzing (old word for blueing). This bronzing process was carried out without the help of the common auxiliaries of today such as boiling baths and steel brushes. This had nothing in common with modern blueing. It is a wet-chemical process with which a black layer of iron oxide (Fe₃O₄) is created on the surface of iron and steel materials. The parts to be blued are immersed in a boiling alkaline oxidizing solution at a temperature of 135 - 145°C. Layers with a thickness of 0.2 - 2 µm are thus created. Due to the low treatment temperature it is possible without any problem to also treat parts which have already been hardened. Additional oiling makes the parts even more corrosion resistant. To maintain this corrosion protection, however, it is necessary to apply a corresponding oil to the blued parts once in a while.

S

tock types:

A basic principle of shooting: The barrel shoots, the stock hits the target. Only a stock that fits the shooter perfectly makes a correct position possible.

Stock design:

The ANSCHÜTZ stock design corresponds to the requirements of traditional and competitive hunters.

When choosing a stock it is important to know which purpose it is for and many hunters have their favorites:



Competition stock:

We have developed a special walnut stock for competitive hunting with checkering at pistol grip and fore-end. In addition the ventilated rubber butt plate guarantees a safe position. A pistol grip cap of rosewood with white liner makes this rifle an elegant model for competitive hunting.



Classic stock:

Classic straight walnut stock with checkering at pistol grip and fore-end as well as black butt plate. Depending on model also available with studs for sling swivel.



Monte Carlo stock:

Walnut stock with roll-over cheek piece, with schnabel tipped fore-end, pistol grip cap of rosewood with white liner, hand checkering at pistol grip and fore-end, black plastic butt plate with white liner and studs for sling swivel.



Monte Carlo fiber glass stock:

Weather proof fiber glass stock with roll-over cheek piece, schnabel tipped fore-end, checkering at pistol grip and fore-end, black plastic butt plate.



Stock in Monte Carlo version:

Walnut stock in Monte Carlo version with schnabel tipped fore-end, checkering at pistol grip and fore-end, black butt plate with checkering and white liner, studs for sling swivel.



Beavertail stock:

The Beavertail stock has nothing in common with the classic, European hunting stock. It resulted from the demands of North American hunters and combines the advantages of a classic target stock with the wide beavertail fore-end stock. With a rail in the fore-end stock this type of stock finds more and more fans.



Beavertail fore-end stock

Barreled Actions

BARRELED ACTIONS

Barreled action Match 64:

The Luxus repeaters of the series 1416, 1516, and 64:

The action is a bolt action with cam cocking system, claw extractor and additional cartridge holder and ejector. An 11 mm grooved receiver drilled and tapped for scope mounts makes it possible to attach a telescopic sight.

A lateral sliding safety blocks the trigger. The rifle can be loaded and unloaded in the "safe" position.

The bolt face is recessed for full cartridge head support. An additional gas escape groove guarantees safety.

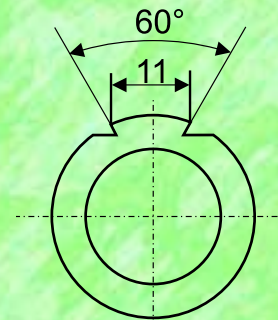

11 mm grooved receiver drilled and tapped for scope mounts.

Barreled action Match 54:

Hunting repeaters of the series 1700:

ANSCHÜTZ target rifles are famous for their solid design, functionality and unsurpassed performance all around the world.

The ANSCHÜTZ match cylinder action which is also part of the ANSCHÜTZ hunting repeaters dominates national, international, Olympic and world championship competitions in the small bore rifle disciplines.

The bolt with dual locking lugs is seated eccentrically in the receiver to give the action screws more support for better stock bedding. The bolt is cam cocking. Fast and trouble-free repeating is guaranteed by claw extractor and the additional cartridge holder with ejector - a feature from the famous ANSCHÜTZ Fortner Biathlon rifles.

The receiver is equipped with an 11 mm (7/16") wide grooved receiver rail and is additionally drilled and tapped for scope mounts. The bolt face is recessed for full cartridge head support.

An independent lateral bolt stop limits the travel of the bolt and thus protects the trigger as well. An additional gas escape groove guarantees safety. The wing safety pulls and holds the firing pin back when operated into the safe position.



Eccentrically seated bolt in the receiver.

Match 64

Match 54



Barreled Action Match 64

REPEATERS OF THE SERIES 1416



Repeaters of the series 1416:

The action is a bolt action with cam cocking system, claw extractor and additional cartridge holder and ejector. An 11 mm grooved receiver drilled and tapped for scope mounts makes it possible to attach a telescopic sight. A lateral sliding safety blocks the trigger. The rifle can be loaded and unloaded in the "safe" position. The bolt face is recessed for full cartridge head support. An additional gas escape groove guarantees safety.

Trigger:

Two stage trigger and single stage trigger correspond to the match triggers, which are used in the ANSCHÜTZ target rifles of the models 1903. The light

weight, hardened and polished parts guarantee a smooth and precise release of the trigger.

Barrel:

The barrels are manufactured using the same special process perfected for our target rifles. The same attention to detail is given to the fitting of the receiver and the counterbore at the muzzle.

Sight sets:

Folding leaf sight adjustable in height and pearl front sight adjustable in height on ramp with hood.



KL = Folding leaf sight.



Pearl front sight adjustable in height.



ST = Double set trigger.



G = Barrel thread.



Classic stock:

Classic straight hunting stock of colored and lacquered walnut wood without cheek piece, checkering at pistol grip and fore-end, black butt plate and studs for sling swivel.



Caliber .22 l.r.



Good gripping properties of checkered surface even in rain.

Studs, sling swivels and slings see accessories.



Model 1416 L D KL Walnut Classic, caliber .22 l.r.



Grouping 1416
10 shots .22 l.r.
on 50 m.
Original size.

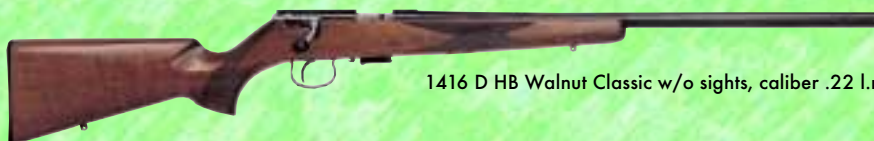

1416 D HB Walnut Classic w/o sights, caliber .22 l.r.

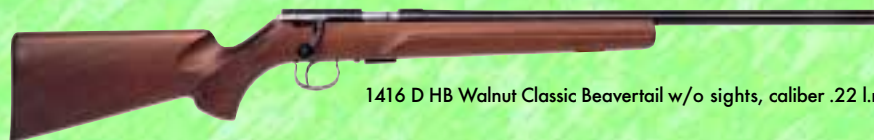

1416 D HB Walnut Classic Beavertail w/o sights, caliber .22 l.r.



1417 G Walnut Classic w/o sights, caliber .22 l.r.



1416 D KL Walnut Monte Carlo, caliber .22 l.r.



Barreled Action Match 64

REPEATERS OF THE SERIES 1502 / 1516 / 1517



Repeaters of the series 1502 / 1516 / 1517:

Barreled action and version like for the models of the series 1416, but series 1502 in the new caliber .17 Mach 2, the series 1516 in cal. .22 Win. Mag. R.F., and the models 1517 in cal. .17 HMR.



Repeater of the series 1502:

Shot Show 2004 - a new caliber is born:

Caliber .17 Mach 2. ANSCHÜTZ again was able to present the best partner for this ammunition.

Barreled action and version correspond to the models of the series 1416. Available with heavy barrel (HB) and Classic stock. Grooved, 11 mm rail is drilled and tapped to accept a telescopic sight.



Repeater of the series 1517:

Models 1517 in cal. .17 HMR. The caliber .17 HMR (Hornady Magnum Rimfire) with a bullet diameter of 4.5 mm has been the most innovative ammunition development in the USA in the past few years. At the Shot Show 2002 in Las Vegas, USA, ANSCHÜTZ presented a trend-setting rifle for this caliber as one of the first manufacturers worldwide. The renowned ANSCHÜTZ accuracy and quality is now also available for the new model 1517 for the world's fastest rimfire cartridge.

Depending on the referring version the rifle is equipped with a Match 64 cylinder action and a single or two stage trig-

ger adjusted to 1100 g thus offering an optimum of reliability.

The stock is a walnut stock in Classic or Monte Carlo version. A beavertail stock with rail is available on demand. Depending on the model the rifle is offered without sights, with a folding rear sight or a grooved, 11 mm rail drilled and tapped to accept a telescopic sight or a rear sight. Fans of the caliber .17 HMR may look forward to a further top quality ANSCHÜTZ product.



Repeaters of the series 1516:

The models of the series 1516 in cal. .22 Win. Mag. R.F. have a long tradition at ANSCHÜTZ. This classic caliber with a bullet diameter of 5.5 mm was launched by Winchester in 1959. It is extraordinarily suitable to be used for small animals up to the size of a fox at a distance of up to 100 m.



KL = Folding leaf sight.



Pearl front sight adjustable in height.





Classic stock:

Classic straight hunting stock of colored and lacquered walnut wood without cheek piece, checkering at pistol grip and fore-end, black butt plate and studs for sling swivel.

Beavertail stock:

The Beavertail stock has nothing in common with the classic, European hunting stock. It resulted from the demands of North American hunters and combines the advantages of a classic target stock with the wide beavertail fore-end stock. With a rail in the fore-end stock this type of stock finds more and more fans.

Heavy barrel.

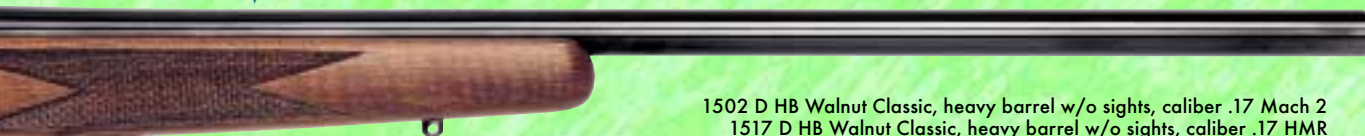

1502 D HB Walnut Classic, heavy barrel w/o sights, caliber .17 Mach 2
1517 D HB Walnut Classic, heavy barrel w/o sights, caliber .17 HMR
1517 D Walnut Classic w/o sights, caliber .17 HMR
1517L D Walnut Classic w/o sights, caliber .17 HMR

Good gripping properties of checkered surface even in rain.

Studs, sling swivels and slings see accessories.

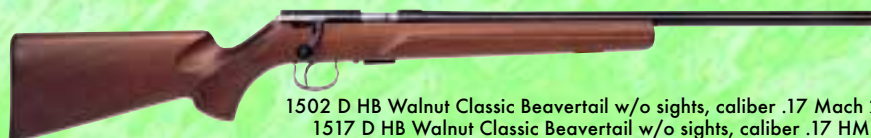

1502 D HB Walnut Classic Beavertail w/o sights, caliber .17 Mach 2
1517 D HB Walnut Classic Beavertail w/o sights, caliber .17 HMR



Grouping 1516
10 shots .22 WMR
on 50 m.
Original size.



1516 D KL Walnut Classic, caliber .22 Win. Mag. R.F.



1517 MP R Hardwood Multi Purpose w/o sights, caliber .17 HMR



Grouping 1517
10 shots .17 HMR
on 50 m.
Original size.

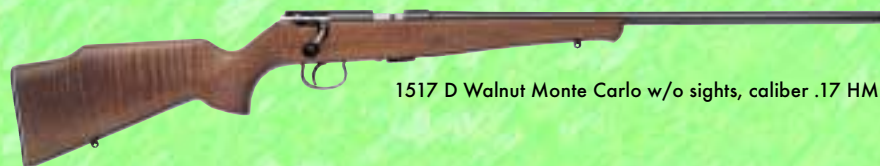

1517 D Walnut Monte Carlo w/o sights, caliber .17 HMR

Stock in Monte Carlo version:

Walnut stock in Monte Carlo version with schnabel tipped fore-end, checkering at pistol grip and fore-end, black butt plate with checkering and white liner, studs for sling swivel.



Barreled Action Match 64

HUNTING MATCH REPEATERS OF THE SERIES 64



Small bore hunting match repeaters of the series 64:

Barreled action and version like for the models of the series 1416 and 1516 but with different stock versions and equipped with renowned precision heavy barrel.



Small bore hunting match repeater of the series 64 MPR Multi Purpose:

Based on the renowned match barreled action 64 in cal. .22 l.r. Equipped with a match two stage trigger, heavy barrel and the universal multi purpose beavertail stock - a version which finds more and more fans. Bolt action with cam cocking system, claw extractor with additional cartridge holder and ejector.



An 11 mm grooved receiver drilled and tapped for scope mounts makes it possible to attach a telescopic sight or match rear sight. A lateral sliding safety blocks the trigger. The rifle can be loaded and unloaded in the "safe" position. The bolt face is recessed for full cartridge head support. An additional gas escape groove guarantees safety.



Caliber .22 l.r.

Magazine easy to exchange.

Match two stage trigger with adjustable trigger blade.

Rubber butt plate 4709 A.



Adjustable rubber butt plate.



Grooved alu rail for hand stop or other accessories.



Caliber .22 l.r.



Small bore hunting match repeater of the series 64 R Sporter Target: Barreled action Match 64 in cal. .22 l.r. With match two stage trigger and perfectly shaped hardwood stock with aluminium rail.

A repeater for the field as well as for competitive shooting on targets. With the single loader adapter 4846 this rifle can also be used as a single loader.



64 R Sporter Target Hardwood, with grooved alu rail, caliber .22 l.r.

Precision heavy barrel.



64 MP R Hardwood Multi Purpose with grooved alu rail w/o sights, caliber .22 l.r.

Grooved alu rail for hand stop.
Also see accessories.



64 MP R Hardwood Multi Purpose with grooved alu rail w/o sights, caliber .22 l.r.
Picture with accessories.

- ① Alu butt plate 4758.
Item No.: 700.3592
 - ② Rubber butt plate 4709 B-U1, convex.
Item No.: 710.3710
 - ③ Spacer 4709 P, 8 mm.
Item No.: 710.3750
 - ④ Sight set 6834.
Item No.: 700.0060
 - ⑤ Single loader adapter 4846.
Item No.: 710.4700
 - ⑥ 5-shot magazine 1420-U 5.
Item No.: 700.4005
 - ⑦ Hand stop 6226, with sling swivel.
Item No.: 710.3600
 - ⑧ Sling 7400, leather.
Item No.: 710.3015
 - ⑨ Mounts 5516/26-1, 2 pieces, 21 mm high with ring Ø 26 mm.
Item No.: 710.1600
- Mounts 5516/30, 2 pieces, 21 mm high with ring Ø 30 mm.
Item No.: 710.1630

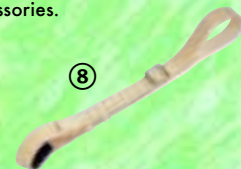

Barreled Action Match 54

HUNTING REPEATERS OF THE SERIES 1700



Hunting repeaters of the series 1700:

ANSCHÜTZ target rifles are famous for their solid design, functionality and unsurpassed performance all around the world.

The ANSCHÜTZ match cylinder action which is also part of the ANSCHÜTZ hunting repeaters dominates national, international, Olympic and world championship competitions in the small bore rifle disciplines. Buying such a hunting repeater does not only mean to acquire state-of-the-art technology but also a master piece in a class of its own.

Action:

The bolt with dual locking lugs is seated eccentrically in the receiver to give the action screws more support for better stock bedding. The bolt is cam cocking. Fast and trouble-free repeating is guaranteed by claw extractor and the additional cartridge holder with ejector. This precision makes ANSCHÜTZ hun-

ting repeaters a reliable partner in the field and in the forest. The receiver is equipped with an 11 mm (7/16") wide grooved receiver rail and is additionally drilled and tapped for scope mounts. The bolt face is recessed for full cartridge head support. An independent lateral bolt stop limits the travel of the bolt and thus protects the trigger as well. An additional gas escape groove guarantees safety.

Safety:

The wing safety pulls and holds the firing pin back when operated into the safe position.

Trigger:

Two stage trigger and single stage trigger correspond to the match triggers of the ANSCHÜTZ target rifles. The low-weight, hardened and finely polished triggers enable a fast and precise release of the trigger.

Barrel:

The barrels are manufactured using the same special process perfected for the ANSCHÜTZ target rifles. The same attention to detail is given to the fitting of the receiver and the counterbore at the muzzle.



KL = Folding leaf sight.



Caliber .22 l.r.



Monte Carlo stock with roll-over cheek piece.



Pearl front sight adjustable in height.



Sight sets:

Folding leaf sight adjustable in height and pearl front sight adjustable in height on ramp with hood.

Monte Carlo stock:

Walnut stock with roll-over cheek piece, with fore-end schnabel tip, pistol grip cap of rosewood with white liner, hand checkering at pistol grip and fore-end, black plastic butt plate with white liner and studs for sling swivel.



Good gripping properties of checkered surface even in rain.

Studs, sling swivels and slings see accessories.

1710 ST KL Walnut Monte Carlo, caliber .22 l.r.
1710 ST KL Walnut Monte Carlo Meister Grade, caliber .22 l.r.



1710 D KL Walnut Monte Carlo Meister Grade, caliber .22 l.r.
1710 D KL Walnut Monte Carlo, caliber .22 l.r.
1717 D KL Walnut Monte Carlo, caliber .17 HMR
1717 D KL Walnut Monte Carlo Meister Grade, caliber .17 HMR



Grouping 1710 D
10 shots .22 l.r.
on 50 m.
Original size.



1712 Silhouette Sporter Walnut Monte Carlo w/o sights, caliber .22 l.r. with two stage trigger and adjustable trigger blade.



Grouping 1717 D
10 shots .17 HMR
on 50 m.
Original size.

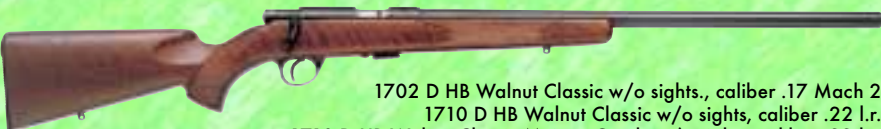

1702 D HB Walnut Classic w/o sights., caliber .17 Mach 2
1710 D HB Walnut Classic w/o sights, caliber .22 l.r.
1710 D HB Walnut Classic Meister Grade w/o sights, caliber .22 l.r.
1717 D HB Walnut Classic w/o sights, caliber .17 HMR
1717 D HB Walnut Classic Meister Grade w/o sights, caliber .17 HMR
1717 D Walnut Classic w/o sights, caliber .17 HMR
1717 D Walnut Classic Meister Grade w/o sights, caliber .17 HMR



Barreled Action Match 54

HUNTING REPEATERS OF THE SERIES 1700



Hunting repeaters of the series 1700:

With regard to function and version of bolt, safety, trigger and barrel the model series 1730 and 1740 correspond to the model series 1710, 1712 and 1717 which are described on the previous pages. These models, however, are in the calibers .22 Hornet and .222 Remington.



ST = Double set trigger. Here of the model 1730 ST KL Walnut Monte Carlo.



KL = Folding leaf sight.



Monte Carlo stock with roll-over cheek piece.



Pearl front sight adjustable in height.





Heavy barrel.



1730 D HB Walnut Classic w/o sights, caliber .22 Hornet
 1730 D HB Walnut Classic Meister Grade w/o sights, caliber .22 Hornet
 1740 D HB Walnut Classic w/o sights, caliber .222 Remington
 1740 D HB Walnut Classic Meister Grade w/o sights, caliber .222 Remington

Good gripping properties of checkered surface even in rain.

Studs, sling swivels and slings see accessories.



Grouping 1730 D
 10 shots .22 Hornet
 on 100 m.
 Original size.



1730 D KL Walnut Monte Carlo, caliber .22 Hornet
 1730 D KL Walnut Monte Carlo Meister Grade, caliber .22 Hornet
 1730 ST KL Walnut Monte Carlo, caliber .22 Hornet
 1730 ST KL Walnut Monte Carlo Meister Grade, caliber .22 Hornet
 1740 D KL Walnut Monte Carlo, caliber .222 Remington
 1740 D KL Walnut Monte Carlo Meister Grade, caliber .222 Remington
 1740 ST KL Walnut Monte Carlo, caliber .222 Remington
 1740 ST KL Walnut Monte Carlo Meister Grade, caliber .222 Remington

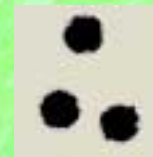

Grouping 1740 D
 10 shots
 .222 Remington
 on 100 m.
 Original size.



Barreled Action Match 54

COMPETITION HUNTING SINGLE LOADERS



Competition hunting single loaders: High accuracy hunting competition rifles which can be used for hunting as well.

The bolt action comes from the top series of the ANSCHÜTZ 54 Match rifles and can be equipped with a double set trigger or a two stage trigger.

The heavy match barrel is manufactured according to the same technology as the unsurpassed ANSCHÜTZ target rifles. The walnut stock is designed for competitive hunting and has a checkering at pistol grip and fore-end.

With ventilated rubber butt plate and pistol grip cap of rosewood with white liner.



Caliber .222 Remington.

Match two stage trigger.

Checkering at pistol grip and fore-end, pistol grip cap of rosewood with white liner.

Ventilated rubber butt plate with white liner.



Match two stage trigger 5073.



ST = Double set trigger 5007.





Heavy precision match barrel.



Checkering.

1740 E Walnut w/o sights, caliber .222 Remington
1740 E ST Walnut w/o sights, caliber .222 Remington



These hunting targets are shot at a distance of 100 m.



Blowback Action

SEMI AUTOMATIC RIFLES OF THE SERIES 525



Semi automatic rifles model 525: Receiver with blowback action and 11 mm rail for telescopic sight, lateral gas vents and deflector plate for safe ejection of fired cases. The trigger housing with its ejector and lateral turnable safety carries the complete release mechanism with a very fast turning hammer for a short lock time. The barrel is manufactured according to the special ANSCHÜTZ process and is secured to the receiver by a single tapered assembly screw.

Sight sets: Folding leaf sight adjustable in height together with a pearl front sight adjustable in height which is screwed into the ramp and equipped with hood.

The Beavertail fore-end stock with checkering, sling swivel and the hardwood stock with checkering at the pistol grip, butt plate and sling swivel is walnut stained and lacquered.

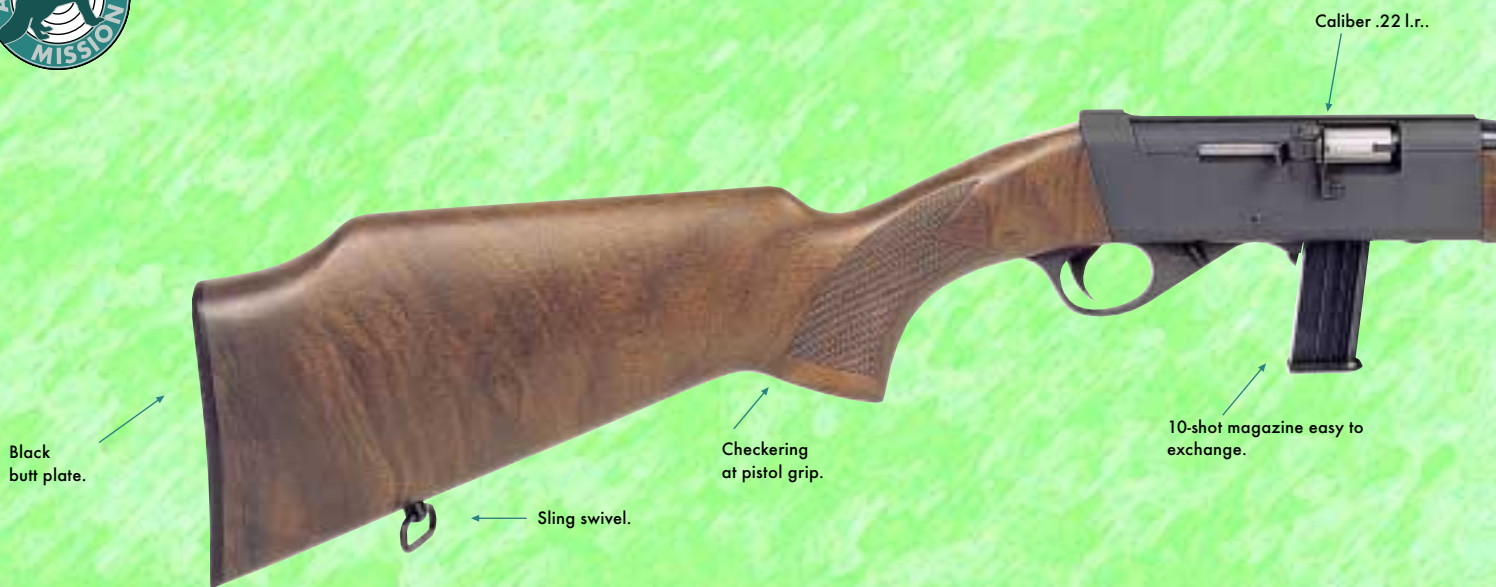

KL = Folding leaf sight.



Pearl front sight adjustable in height.



G = Barrel thread.





Magazine 525-U8, 10 shots.
Magazine 525-U10, 2 shots.



525 KL, caliber .22 l.r.
525 KL G, caliber .22 l.r.



Model 1365 GARDEN SHOTGUN MODEL 1365



Garden shotgun model 1365:
This single barrel shotgun with cylinder action and bolt handle lock in cal. 9 mm Flobert shot is designed for varmint control in the garden, on the yard and in the field. The sighting groove on the receiver is in line with the front sight and the walnut stained hardwood stock thus guaranteeing reliable aiming. A lateral safety blocks the trigger in the "safe" position.



Double shot, caliber 9 mm.



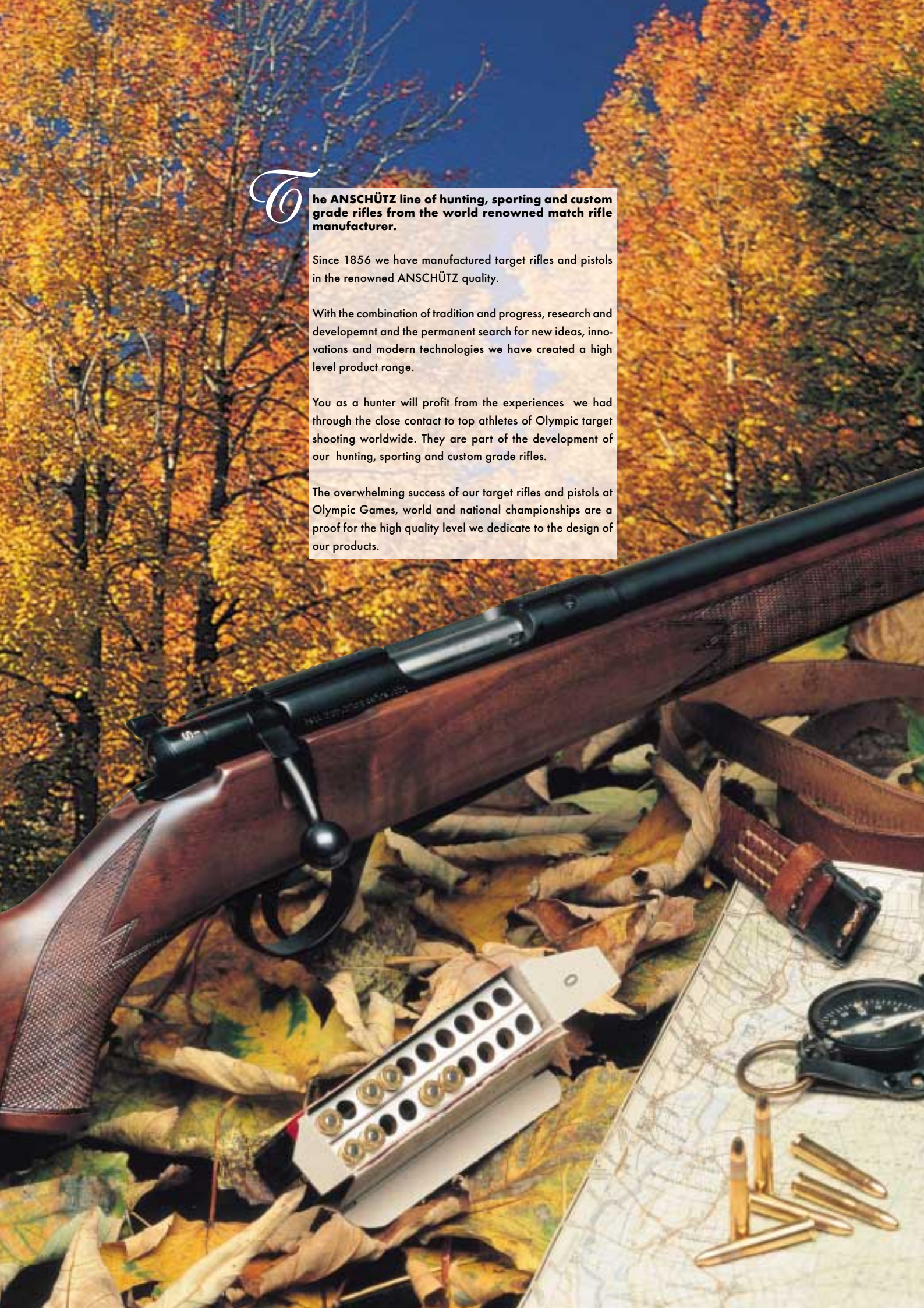

The ANSCHÜTZ line of hunting, sporting and custom grade rifles from the world renowned match rifle manufacturer.

Since 1856 we have manufactured target rifles and pistols in the renowned ANSCHÜTZ quality.

With the combination of tradition and progress, research and development and the permanent search for new ideas, innovations and modern technologies we have created a high level product range.

You as a hunter will profit from the experiences we had through the close contact to top athletes of Olympic target shooting worldwide. They are part of the development of our hunting, sporting and custom grade rifles.

The overwhelming success of our target rifles and pistols at Olympic Games, world and national championships are a proof for the high quality level we dedicate to the design of our products.

Special Versions

INDIVIDUAL SPECIAL VERSIONS

S

Special versions:

In case you have not found your special version on the previous pages we would be pleased to compose it for you and submit you an individual offer. To do this we would need a detailed specification. Special versions are excluded from being exchanged.

Special version:

Model 1710 D KL Monte Carlo
caliber .22 l.r.



Special version:
Model 1730 D Classic
caliber .22 Hornet.



Masterpiece hand made engravings:

Give your ANSCHÜTZ rifle a personal touch. A high quality individually designed hunting rifle is an investment for generations.

Make your emotions visible-

We realise your artistic ideas, adventures and hunting preferences on your rifle.

Whether you decide for a precious relief engraving or a signature engraving on your trigger guard or if you wish to have your individual special version with artistic decorations - do not hesitate to contact your dealer or our sales staff.



↑
Exclusive engraving:
Precious relief engraving with artistic chasing. Different chasing on demand.
Item No: 860.0010



↑
Signature engraving:
Individual engraving of your signature. Let us have your signature in black on a white piece of paper.
Item No: 860.0005



Special version:
Model 1730 ST KL Monte Carlo, caliber .22 Hornet.



Special version:
Model 1740 D KL Monte Carlo caliber .222 Remington.



Accessories

ACCESSORIES

Knives



↑
ANSCHÜTZ hunting knife:
 Horn grip, approx. 85 mm long blade of stainless high speed steel. Locking mechanism blocks opened blade. Complete with brown scabbard of robust saddle leather, with grinding rod.
Item No.: 710.4010



↑
ANSCHÜTZ hunting knife:
 With wooden grip. Approx. 100 mm long blade of stainless high speed steel. Complete with brown scabbard of robust saddle leather.
Item No.: 710.4005

clothing



← **Water proof All Weather Jacket:**
 With removable, reversible, sleeved body warmer, nylon hood in collar. Nylon/Taffeta, 100 % polyamide, PU coated, breathable. This ANSCHÜTZ jacket offers you an inner lining with bag and large cartridge bags.

- Size S: **Item No.: 680.6003**
- Size M: **Item No.: 680.6004**
- Size L: **Item No.: 680.6005**
- Size XL: **Item No.: 680.6006**
- Size XXL: **Item No.: 680.6007**



↑
ANSCHÜTZ Cap 7910:
 Fits all head sizes.
Item No.: 711.6450

*S*afety



↑
Safety lock for triggers:
Protects your rifle from unauthorized use. Suitable for all ANSCHÜTZ rifles. Caution: Only install at an unloaded rifle. Store your rifle in unloaded condition.



↑
Safety lock for triggers.
Item No.: 711.7250



Removable sling swivel:
Euro 8 mm hinge width. Optimum solution for a fast exchange and removal of slings. 2 pieces.
Item No.: 711.9010



*S*lings

↑
Slings:
With rubber layer and penetrated plait decoration. Adjustable length 87 - 101 cm (34-40"). Width 35 mm (1.4"). Color dark green.
Item No.: 711.9005

*S*tones



↑
ANSCHÜTZ stone:
Item No.: 799.1500

ANSCHÜTZ stone, small:
Item No.: 799.1510

Accessories

ACCESSORIES

Gun cases



↑
Gun case 201:
 For 1 rifle (122.5 x 25.5 x 11.5 cm, 3.25 kg).
Item No.: 711.8000



↑
Gun case 233:
 For 1 break-down gun (96.5 x 32 x 11.5 cm, 3.5 kg).
Item No.: 711.8003



↑
Gun case 202:
 For 2 rifles (133.5 x 32 x 11.5 cm, 4.6 kg).
Item No.: 711.8001



↑
Gun case 203:
 Extra wide for 2 rifles and accessories (133.5 x 37 x 11.5 cm, 4.9 kg).
Item No.: : 711.800.



↑
Hunting gun case 261:
 For 1 hunting gun with telescopic sight (135 x 28.5 x 11 cm, 2.1 kg).
Item No.: 711.8011
 ↓



↑
Gun case 285:
 Water proof, for 2 rifles and accessories (137 x 39 x 15 cm, 7.1 kg).
Item No.: 711.8005





↑
Hunting and sports bag 294:
A practical ANSCHÜTZ development!
Large bag for hunters and target shooters with special compartment for shotgun case and many additional bags.

Finally a bag for everything! Ideal for flights. With extendable frame grip and rolls (91 x 42 x 38 cm).
Item No.: 711.8150

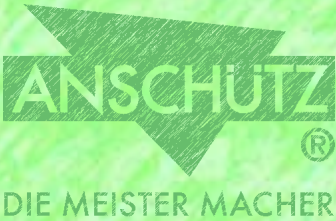

*M*ounts / sights
for 11 mm grooved rail



↑
Two-piece mount 5516/26-1,
21 mm height, with rings
Ø 26 mm/1".
Item No.: 710.1600



↑
Two-piece mount 5516/30,
21 mm height, with rings
Ø 30 mm/1 1/5".
Item No.: 710.1630



↑
Sight set 6834, rear sight 6805,
front sight 6832, rubber eyeshade,
7 inserts.
Item No.: 700.0060



↑
Two-piece mount 5525/26-1,
31 mm height, with rings
Ø 26 mm/1".
Item No.: 710.1610



↑
Two-piece mount 5525/30,
31 mm height, with rings
Ø 30 mm/1 1/5".
Item No.: 710.1620

Accessories

ACCESSORIES

Magazines



↑
Magazine 525-U8, 10 shots,
 .22 l.r. for semi automatic rifle.
Item No.: 700.4110



↑
Magazine 525-U10, 2 shots,
 .22 l.r. for semi automatic rifle.
Item No.: 700.4111



↑
Magazine 1420-U5, 5 shots,
 .22 l.r. and .17 Mach 2
Item No.: 700.4005



↑
Magazine 1420-U13, 10 shots,
 .22 l.r. and .17 Mach 2.
Item No.: 700.4010



↑
Magazine 54.18 MS R-U2 thumb-
hole,
 5 shots, for 1808 stock, .22 l.r.
Item No.: 700.4260



↑
Magazine 1515-U3, 4 shots,
 .22 Win. Mag. and .17 HMR.
Item No.: 700.4304



↑
Magazine 1430-U4, 5 shots,
 .22 Hornet.
Item No.: 700.4405



↑
Magazine 1530-U4, 3 shots,
 .222 Remington.
Item No.: 700.4503



↑
Single loader adapter 4846,
 for repeaters in caliber .22 l.r.
Item No.: 710.4700

S tickers



↑ **ANSCHÜTZ sticker (to sew on):**
Approx. 85 x 55 mm.
Material 100% polyester.
Item No.: 799.3005



↑ **ANSCHÜTZ sticker (adhesive):**
Approx. 100 x 70 mm.
Item No.: 799.3010

P rotectives



↑ **Electronic mufflers 307:**
Automatic sound insulation is actuated at props. Speech permeability. No obstacle during shooting. Extraordinary insulating properties. Variably adjustable. With connection for cigarette lighter and socket (220 V) to load accus.
Item No.: 710.6700



↑ **Peltor pocket mufflers 313:**
The slim design makes them especially suitable for target shooters. Very light (approx. 180 g). Comfortable fit. Considerable sound insulation. Variably adjustable.
Item No.: 710.6701



↑ **Pocket mufflers 308**
A special product development for the shooter with regard to sound dissipation. Very light (approx. 196 g). Foldable. Wide, soft sealing rings. No obstacle during shooting. Comfortable fit.
Item No.: 710.6702

Accessories

ACCESSORIES



↑
Cleaning kit 507.
Item No.: 710.6325



↑
Cleaning wicks 508.
Item No.: 710.6326

Cleaning



↑
Cleaning kit,
with 4-piece cleaning rod.
Item No.: 710.6332

Visit us in the internet:
www.anschuetz-sport.com

Note:

Product specifications, design and model changes are subject to change without prior notice. Dimensions and colors are subject to change. With reservation of misprints and errors. Goods are subject to prior sale.

Delivery subject to the presentation of the referring license for the purchase of firearms.

ANSCHÜTZ, the ANSCHÜTZ logo and the ANSCHÜTZ logo in connection with the slogan "Die Meister Macher" (also in modified spelling) are protected brands of J.G. ANSCHÜTZ GmbH & Co. KG, Ulm, Germany. The unauthorized use of this brand name is not allowed and punishable.

All rights of this catalogue reserved. The use of the catalogue, also in excerpts, is not allowed without the permission of J. G. ANSCHÜTZ GmbH & Co. KG and otherwise is punishable. This is especially applicable for unauthorized copying, translations and read-ins into electronic systems.

Order Chart

ORDER CHART

Model description	Item No.	Caliber	Magazine	Trigger	Weight	Barrel length	Total length
1365							
1365 Hardwood*	160.0000	9mm Flobert Shot		5165	2.1 kg / 4.6 lbs.	65 cm / 25.6"	110 cm / 43.3
14xx (Barreled Action Match 64)							
1416 D KL Classic	217.2020	.22 l.r.	5 Shots	5094	2.5 kg / 5.5 lbs.	58.4 cm / 23"	105.5 cm / 41.5"
1416 D KL Monte Carlo	217.2000	.22 l.r.	5 Shots	5094	2.5 kg / 5.5 lbs.	58.4 cm / 23"	105.5 cm / 41.5"
1416L D KL Classic	217.3060	.22 l.r.	5 Shots	5094L	2.5 kg / 5.5 lbs.	58.4 cm / 23"	105.5 cm / 41.5"
1416 D HB Classic wos.	217.2080	.22 l.r.	5 Shots	5094	2.7 kg / 6.0 lbs.	58.4 cm / 23"	105.5 cm / 41.5"
1416 D HB Classic Beavertail wos.	217.4005	.22 l.r.	5 Shots	5094	2.7 kg / 6.0 lbs.	58.4 cm / 23"	105.5 cm / 41.5"
1417 G Classic o.V.	217.9810	.22 l.r.	5 Shots	5092	2.4 kg / 5.2 lbs.	35.5 cm / 14"	83 cm / 32.7"
15xx and 64 (Barreled Action Match 64)							
1502 D HB Classic wos.	240.2095	.17 Mach 2	5 Shots	5094	2.7 kg / 6.0 lbs.	58.4 cm / 23"	105.5 cm / 41.5"
1502 D HB Classic Beavertail wos.	240.4005	.17 Mach 2	5 Shots	5094	2.7 kg / 6.0 lbs.	58.4 cm / 23"	105.5 cm / 41.5"
1516 D KL Classic	231.2020	.22 WMR	4 Shots	5094	2.5 kg / 5.5 lbs.	58.4 cm / 23"	105.5 cm / 41.5"
1517 D HB Classic wos.	221.2095	.17 HMR	4 Shots	5094	2.7 kg / 6.0 lbs.	58.4 cm / 23"	105.5 cm / 41.5"
1517 D HB Classic Beavertail wos.	221.4005	.17 HMR	4 Shots	5094	2.7 kg / 6.0 lbs.	58.4 cm / 23"	105.5 cm / 41.5"
1517 D Classic wos.	221.2023	.17 HMR	4 Shots	5094	2.5 kg / 5.5 lbs.	58.4 cm / 23"	105.5 cm / 41.5"
1517L D Classic wos.	221.3095	.17 HMR	4 Shots	5094	2.5 kg / 5.5 lbs.	58.4 cm / 23"	105.5 cm / 41.5"
1517 D Monte Carlo wos.	221.2033	.17 HMR	4 Shots	5094	2.5 kg / 5.5 lbs.	58.4 cm / 23"	105.5 cm / 41.5"
1517 MP R Hardwood wr., wos.	221.4102	.17 HMR	4 Shots	5106	4.1 kg / 9.0 lbs.	65 cm / 25.5"	105.5 cm / 41.5"
64 MP R Hardwood wr., wos.	219.4002	.22 l.r.	5 Shots	5092	4.1 kg / 9.0 lbs.	65 cm / 25.5"	110 cm / 43.3"
64 R Sporter Target Hardwood wr., wos.	219.4500	.22 l.r.	5 Shots	5092	4.1 kg / 9.0 lbs.	65 cm / 25.5"	110 cm / 43.3"
17xx (Barreled Action Match 54)							
1702 D HB Classic wos.	242.2095	.17 Mach 2	5 Shots	5096 D	3.6 kg / 8 lbs.	58.4 cm / 23"	107.5 cm / 43.3"
1712 Silh. Sporter Monte Carlo wos.	220.1033	.22 l.r.	5 Shots	5109	3.3 kg / 7.3 lbs.	54.9 cm / 21.6"	104 cm / 40.9"
1710 D KL Monte-Carlo	220.2030	.22 l.r.	5 Shots	5096 D	3.4 kg / 7.5 lbs.	58.4 cm / 23"	107.5 cm / 43.3"
1710 D KL Monte-Carlo Meister Grade	220.2040	.22 l.r.	5 Shots	5096 D	3.4 kg / 7.5 lbs.	58.4 cm / 23"	107.5 cm / 43.3"
1710 D HB Classic wos.	220.2095	.22 l.r.	5 Shots	5096 D	3.6 kg / 8 lbs.	58.4 cm / 23"	107.5 cm / 43.3"
1710 D HB Classic Meister Grade wos.	220.2096	.22 l.r.	5 Shots	5096 D	3.6 kg / 8 lbs.	58.4 cm / 23"	107.5 cm / 43.3"
1710 ST KL Monte-Carlo	220.4030	.22 l.r.	5 Shots	5001	3.4 kg / 7.5 lbs.	58.4 cm / 23"	107.5 cm / 43.3"
1710 ST KL Monte-Carlo Meister Grade	220.4040	.22 l.r.	5 Shots	5001	3.4 kg / 7.5 lbs.	58.4 cm / 23"	107.5 cm / 43.3"
1717 D KL Monte-Carlo	222.2030	.17 HMR	4 Shots	5096 D	3.4 kg / 7.5 lbs.	58.4 cm / 23"	107.5 cm / 43.3"
1717 D KL Monte-Carlo Meister Grade	222.2040	.17 HMR	4 Shots	5096 D	3.4 kg / 7.5 lbs.	58.4 cm / 23"	107.5 cm / 43.3"
1717 D Classic wos.	222.2091	.17 HMR	4 Shots	5096 D	3.4 kg / 7.5 lbs.	58.4 cm / 23"	107.5 cm / 43.3"
1717 D Classic wos. Meister Grade	222.2093	.17 HMR	4 Shots	5096 D	3.4 kg / 7.5 lbs.	58.4 cm / 23"	107.5 cm / 43.3"
1717 D HB Classic wos.	222.2095	.17 HMR	4 Shots	5096 D	3.6 kg / 8 lbs.	58.4 cm / 23"	107.5 cm / 43.3"
1717 D HB Classic wos. Meister Grade	222.2096	.17 HMR	4 Shots	5096 D	3.6 kg / 8 lbs.	58.4 cm / 23"	107.5 cm / 43.3"
17xx (Barreled Action Match 54)							
1730 D KL Monte Carlo	340.2030	.22 Hornet	5 Shots	5096 D	3.4 kg / 7.5 lbs.	58.4 cm / 23"	107.5 cm / 43.3"
1730 D KL Monte Carlo Meister Grade	340.2040	.22 Hornet	5 Shots	5096 D	3.4 kg / 7.5 lbs.	58.4 cm / 23"	107.5 cm / 43.3"
1730 D HB Classic wos.	340.2095	.22 Hornet	5 Shots	5096 D	3.6 kg / 8 lbs.	58.4 cm / 23"	107.5 cm / 43.3"
1730 D HB Classic Meister Grade wos.	340.2096	.22 Hornet	5 Shots	5096 D	3.6 kg / 8 lbs.	58.4 cm / 23"	107.5 cm / 43.3"
1730 ST KL Monte-Carlo	340.4030	.22 Hornet	5 Shots	5001	3.4 kg / 7.5 lbs.	58.4 cm / 23"	107.5 cm / 43.3"
1730 ST KL Monte-Carlo Meister Grade	340.4040	.22 Hornet	5 Shots	5001	3.4 kg / 7.5 lbs.	58.4 cm / 23"	107.5 cm / 43.3"
1740 D KL Monte-Carlo	350.2030	.222 Remington	3 Shots	5095	3.4 kg / 7.5 lbs.	58.4 cm / 23"	107.5 cm / 43.3"
1740 D KL Monte-Carlo Meister Grade	350.2040	.222 Remington	3 Shots	5095	3.4 kg / 7.5 lbs.	58.4 cm / 23"	107.5 cm / 43.3"
1740 D HB Classic wos.	350.2095	.222 Remington	3 Shots	5095	3.6 kg / 8 lbs.	58.4 cm / 23"	107.5 cm / 43.3"
1740 D HB Classic Meister Grade wos.	350.2096	.222 Remington	3 Shots	5095	3.6 kg / 8 lbs.	58.4 cm / 23"	107.5 cm / 43.3"
1740 ST KL Monte-Carlo	350.4030	.222 Remington	3 Shots	5001	3.4 kg / 7.5 lbs.	58.4 cm / 23"	107.5 cm / 43.3"
1740 ST KL Monte-Carlo Meister Grade	350.4040	.222 Remington	3 Shots	5001	3.4 kg / 7.5 lbs.	58.4 cm / 23"	107.5 cm / 43.3"
Single loaders (Barreled Action Match 54)							
1740 E wos.	352.0000	.222 Remington		5073	3.9 kg / 8.6 lbs.	58.4 cm / 23"	106.5 cm / 42"
1740 E ST wos.	352.4000	.222 Remington		5007	3.9 kg / 8.6 lbs.	58.4 cm / 23"	106.5 cm / 42"
525 Semi automatic rifles							
525 KL	225.0000	.22 l.r.	10 Shots	5175	3.1 kg / 6.8 lbs.	61 cm / 2.4"	109 cm / 42.9"
525 KL G	225.6000	.22 l.r.	10 Shots	5175	3.1 kg / 6.8 lbs.	61 cm / 2.4"	109 cm / 42.9"

wos. = Without sights · wr. = With grooved alu rail · D = Single stage trigger · E = Single loader · G = Barrel thread · HB = Heavy barrel · KL = Folding leaf sight · L = Left hand version

MP = Multi Purpose · P = Pistol · R = Repeater · Silh. = Silhouette · ST = Double set trigger · * = As long as available



€ 5,- Fee



ANSCHÜTZ



DIE MEISTER MACHER

J.G. ANSCHÜTZ GmbH & Co. KG
Jagd- und Sportwaffenfabrik

Daimlerstrasse 12
D-89079 Ulm / GERMANY
Postfach 1128
D-89001 Ulm / GERMANY

Phone (+49) - (0) - 7 31 - 40 12-0
Fax (+49) - (0) - 7 31 - 40 12-700
anschuetz-sport.com
JGA-Info@anschuetz-sport.com

ANSCHÜTZ

®

DIE MEISTER MÄCHER



Das Match-Programm The Target Line



150 JAHRE
150 YEARS

Nur wer das Unmögliche versucht wird das Optimale erreichen ...
 Only the one who tries the impossible will reach the optimum ...

ZAGREB 2006

ISSF Weltmeisterschaft ISSF World Championships



Modell 1907 im Schaft 2213
 Model 1907 with stock 2213

15 x GOLD
15 x SILBER
11 x BRONZE

	GOLD	SILBER	BRONZE
KK Liegend Small bore prone			
Herren Men	ANSCHÜTZ	ANSCHÜTZ	
Herren Team Men Team	ANSCHÜTZ 3x	ANSCHÜTZ 1x	ANSCHÜTZ 2x
Damen Women		ANSCHÜTZ	
Damen Team Women Team	ANSCHÜTZ 2x	ANSCHÜTZ 1x	ANSCHÜTZ 2x
Junioren Juniors	ANSCHÜTZ		
Junioren Team Juniors Team	ANSCHÜTZ 2x	ANSCHÜTZ 3x	ANSCHÜTZ 1x
Junioren weiblich Juniors female		ANSCHÜTZ	
Junioren weiblich Team Juniors female Team	ANSCHÜTZ 1x		ANSCHÜTZ 3x
KK 3-Stellung 3 x 40 Small bore 3-position 3 x 40			
Herren Men		ANSCHÜTZ	ANSCHÜTZ
Herren Team Men Team	ANSCHÜTZ 3x		ANSCHÜTZ 3x
Junioren Juniors	ANSCHÜTZ	ANSCHÜTZ	
Junioren Team Juniors Team	ANSCHÜTZ 3x	ANSCHÜTZ 1x	ANSCHÜTZ 3x
KK 3-Stellung 3 x 20 Small bore 3-position 3 x 20			
Damen Women		ANSCHÜTZ	
Damen Team Women Team	ANSCHÜTZ 2x	ANSCHÜTZ 1x	ANSCHÜTZ 3x
Junioren weiblich Juniors female	ANSCHÜTZ	ANSCHÜTZ	
Junioren weiblich Team Juniors female Team	ANSCHÜTZ 3x	ANSCHÜTZ 3x	ANSCHÜTZ 3x
Luftgewehr 10 m Air Rifle 10 m			
Herren Team Men Team	ANSCHÜTZ 1x		
Damen Women		ANSCHÜTZ	
Damen Team Women Team			ANSCHÜTZ 1x
Junioren Juniors		ANSCHÜTZ mit/with 9003 Premium	
Junioren Team Juniors Team	ANSCHÜTZ 1x		
Junioren weiblich Team Juniors female Team	ANSCHÜTZ 1x		ANSCHÜTZ 2x



DIE MEISTER MACHER

J.G. ANSCHÜTZ GmbH & Co. KG
 Jagd- und Sportwaffenfabrik

Daimlerstraße 12
 D-89079 Ulm / GERMANY
 Postfach 1128
 D-89001 Ulm / GERMANY

Fon (+49) - (0) - 7 31- 40 12-0
 Fax (+49) - (0) - 7 31- 40 12-700
 anschuetz-sport.com
 JGA-Info@anschuetz-sport.com

... innovativ, flexibel, kompetent und leistungsbereit fertigen wir seit 1856 Qualitätsprodukte für den Spitzensport.
 ... innovative, flexible, competent and dedicated to accuracy – since 1856 we have manufactured high quality products for target shooting.



1890



1856



1901



1914



1930



1914



1956



1951



1962



1955



1988



DIE MEISTER MACHER

1984



Heute - today

Die Chronik von J.G. ANSCHÜTZ

The History of J.G. ANSCHÜTZ

1856



Der Sohn des Büchsenmachermeisters Johann Heinrich Gottlieb Anschütz, **Julius Gottfried Anschütz** und Ehefrau **Luise Anschütz** gründeten die Firma J.G. Anschütz zur Fertigung von Flobert- und Taschenpistolen, Teschings, Schrotflinten und Lancaster-Terzerole.



ANSCHÜTZ-Werk um 1900.
ANSCHÜTZ factory in 1900.



ANSCHÜTZ-Werk um 1909.
ANSCHÜTZ factory in 1909.



1856

The son of the gunsmith Johann Heinrich Gottlieb Anschütz, **Julius Gottfried Anschütz** and his wife **Luise Anschütz** founded the company J. G. ANSCHÜTZ for the manufacture of Flobert and pocket pistols, Teschings, shotguns and Lancaster Terzerole.

1950

A new beginning in Ulm. The company J. G. ANSCHÜTZ GmbH is founded. The company has 7 employees and 20 machines. In the beginning they make air pistols and carry out repair works, then they start to manufacture Flobert and target rifles. Soon the company has 250 employees. The first target shooting successes come in. Then everything goes very fast.

1968

Dieter Anschütz, representing the 4th generation takes over the management of the company and he continues to this day with all his knowledge, competence and personal engagement to lead the company to an even brighter future.

1972

After the overwhelming success of the ANSCHÜTZ Match Rifle the slogan "**ANSCHÜTZ makes Champions**" ("**DIE MEISTER MACHER**") was created and it is still valid.

1992

Jochen Anschütz, representing the 5th generation becomes president of the company and is now leading it together with his father.

2006

The company celebrates its 150th anniversary. Since its foundation, ANSCHÜTZ stands for innovation and perfection. This has not changed through the years. The name ANSCHÜTZ is inseparably connected with innumerable national and international shooting triumphs. Last but not least the pioneering efforts in biathlon shooting have made the name ANSCHÜTZ recognized all over the world. ANSCHÜTZ products enjoy an extraordinary and worldwide reputation because of their precision, workmanship and accuracy. This is what president Jochen Anschütz - continuing the tradition - puts as a benchmark for the future, to ensure that the long history of ANSCHÜTZ continues to give good memories far into the future.



ANSCHÜTZ-Werk in Ulm.
ANSCHÜTZ factory in Ulm, Germany.

1950

Neubeginn in der Donaubaustation in Ulm. Die Fa. J.G. Anschütz GmbH wird gegründet. Mit 7 Mitarbeitern und 20 Maschinen werden zunächst Luftpistolen und Reparaturen ausgeführt, dann kommen Flobertgewehre und Matchgewehre hinzu. Die Belegschaft wächst schnell auf 250 Mitarbeiter. Erste Erfolge im Schiesssport stellen sich ein, dann geht es Schlag auf Schlag.

1968



Dieter Anschütz, Repräsentant der 4. Generation, übernimmt die Geschäftsführung. Bis auf den heutigen Tag lenkt er mit Fachwissen, unternehmerischer Kompetenz und viel persönlichem Einsatz die Geschicke des Unternehmens.

1972

Die epochalen Erfolge des ANSCHÜTZ-Matchsystems in aller Welt lassen den Slogan "**DIE MEISTER MACHER**" entstehen. Er ist bis auf den heutigen Tag gültig.

1992



Jochen Anschütz tritt als Geschäftsführer in die Firma ein und leitet nun zusammen mit seinem Vater Dieter Anschütz das Unternehmen.

2006

Das Unternehmen feiert sein 150-jähriges Bestehen. Seit seiner Gründung steht ANSCHÜTZ für Innovation und Perfektion. Daran hat sich bis zum heutigen Tag nichts geändert. Der Name ANSCHÜTZ ist untrennbar verbunden mit unzähligen Schiesserfolgen auf nationalem und internationalem Parkett. Nicht zuletzt durch die Pionierarbeit im Biathlon ist er einer grossen Öffentlichkeit ein Begriff. Produkte aus dem Hause ANSCHÜTZ geniessen weltweit allerhöchstes Ansehen aufgrund ihrer Präzision und Verarbeitung. Mit diesem Anspruch geht Geschäftsführer Jochen Anschütz - der Tradition verpflichtet - an die Aufgaben der Zukunft, in dem Bestreben, die lange Geschichte der Firma ANSCHÜTZ erfolgreich weiterzuschreiben.



Das ANSCHÜTZ Buch
Büchsenmacher seit Jahrhunderten.
The ANSCHÜTZ Book
Only available in German..
Best.-Nr.: 799.1511

1
Richard Anschütz, der Bruder von Julius Gottfried (links), sein Sohn Robert (2.v. links) und seine Fabrik, um 1884.



2
Die Anschütz-Familie 1912 vor dem Haus von Julius Gottfried Anschütz. Links steht sein Sohn Fritz August Anschütz, auf der rechten Seite sein Sohn Otto Veit Anschütz. Luise Anschütz sitzt in der Mitte im Kreise ihrer Enkel.

3
JGA-Hammerless-Revolver Nr. 780/781 für die Browning-Patrone, Kal. 6,75 mm, mit eingeschraubtem, gezogenem Stahllauf und einklappbarem Abzug.



4
Titelseite der Netto-Preisliste zum Hauptkatalog Nr. 25, gültig ab 10. September 1922.

5
Werkstattsräume in der alten ANSCHÜTZ-Fabrik, um 1909.



6
Schiesstand, um 1909.

7
Fertigwarenlager, um 1909.

8
Teilansicht der Firma J.G. ANSCHÜTZ um 1944. Dieter Anschütz und seine Eltern wohnten unterhalb des Fabrikdaches. Dieters Spielplatz war der Balkon auf dem Flachdach.



1
Richard Anschütz, the brother of Julius Gottfried (left), his son Robert (2nd from left), and his factory, about 1884.

2
The Anschütz family about 1912 in front of Julius Gottfried's house: on the left side standing you see Fritz August Anschütz, on the right side standing is Otto Veit Anschütz. Luise Anschütz is sitting in the middle.

3
JGA revolver No. 780/781: Hammerless revolver for Browning-Cartridges, cal. 6.75 mm, with screwed-in steel barrel, rifled, with swivelling trigger.

4
Front page of the net price list to the catalogue No. 25, valid from September 10, 1922.

5
Work shop rooms in the old ANSCHÜTZ factory, about 1909.

6
Shooting range, about 1909.

7
Rifle warehouse, about 1909.

8
Part of the ANSCHÜTZ factory about 1944. Dieter and his parents lived underneath the roof of the factory. Dieter's playground was the balcony which was built on the flat roof.



Die Chronik von J.G. ANSCHÜTZ

The History of J.G. ANSCHÜTZ



9
J.G. ANSCHÜTZ Wehrsportkarabiner
Kal. 4 mm lang.

10
Lohngehalt der Firma J.G. ANSCHÜTZ
während der Inflation 1923 über
500.000 Mark, unterzeichnet von
Alma Anschütz (Ehefrau von Otto Veit
Anschütz), garantiert von der Bank
Wachenfeld & Gumprich, Zella-Mehlis.
Der angegebene Betrag konnte nicht in
Bargeld getauscht werden, man konnte
davon nur Lebensmittel oder Kleidung
kaufen.

11
Teilansicht des Schaftröhrlagers mit
ca. 100.000 Stück Nussbaumrohlingen,
in Zella-Mehlis.

12
Hermann Wild, Betriebsleiter der neu
gegründeten Firma J.G. ANSCHÜTZ
GmbH in Ulm, arbeitet 1954 an einem
Prototyp des neuen ANSCHÜTZ-Zylin-
derverschlusses Match 54 unter Aufsicht
von Rudolf Anschütz.

13
Rudolf Charles Anschütz, zwangsver-
pflichtet als Holzfäller im Thüringer Wald,
nach der Enteignung und Demontage
der Firma J.G. ANSCHÜTZ Germania
Waffenwerk.

14
Das erste ANSCHÜTZ-Matchluftgewehr
Modell 220 mit starrem Lauf.

15
Gerd Kümmer, der erste Luftgewehr-
weltmeister überhaupt. 1966 bei den
Weltmeisterschaften in Wiesbaden mit
seinem ANSCHÜTZ-Luftgewehr.

16
August Hollenstein, der Silbermedailen-
gewinner bei den Weltmeisterschaften
gratuliert Gerd Kümmer zu seiner Gold-
medaille in Wiesbaden, Deutschland
1966. Beide Schützen schossen mit dem
ANSCHÜTZ Luftgewehr 250.

17
JGA Luftpistole Nr. 100, Kal. 4,5 mm,
der Germania Waffenwerk AG.

18
Trainingsgewehr der Deutschen Bundes-
wehr nach dem 2. Weltkrieg, das KK-
Modell-54, gefertigt 1956.

9
J.G. ANSCHÜTZ youth military training
rifle cal. 4 mm long.

10
Wages of the J.G. ANSCHÜTZ during
the inflation 1923 of 500.000 Mark,
signed by Alma Anschütz (wife of Otto
Veit Anschütz), guaranteed by the bank
Wachenfeld & Gumprich, Zella-Mehlis.
The indicated amount could not be cashed.
It was only good to buy food, clothing, etc.

11
Part view of stock blanks magazine of
about 100,000 pieces walnut blanks.

12
Hermann Wild, plant manager of the newly
founded company J.G. ANSCHÜTZ
GmbH in Ulm in 1954 working on a
prototype of the new receiver Match 54
under supervision of Rudolf Anschütz.

13
Rudolf Charles Anschütz as wood-cutter
in the Thuringia forest after the expro-
piation and dismantling of the company
J.G. ANSCHÜTZ Germania Waffenwerk.

14
The first ANSCHÜTZ target air rifle
model 220 with fixed barrel.

15
Gerd Kümmer, the first World Champi-
on in air rifle shooting in history. 1966
at the World Championships in Wiesba-
den with his ANSCHÜTZ air rifle.

16
August Hollenstein congratulates Gerd
Kümmer at the World Championships to
his gold medal in Wiesbaden, Germany
1966. Both shooters shot an ANSCHÜTZ
air rifle 250.

17
JGA air pistol No. 100, cal. 4.5 mm of
Germania Waffenwerk AG.

18
Training rifle for the new German army
after World War II, the small bore model
54, manufactured in 1956.

Der Prolog

The Prologue



DIE MEISTER MACHER



Sehr geehrte Sportschützin,
Dear target shooter,
sehr geehrter Sportschütze,
become a member of the group of "Champions"
reihen Sie sich in die Gruppe der
and be inspired by the following pages. This is
"Meister" ein und lassen Sie sich
our new target shooting catalogue, which we
von den folgenden Seiten inspi-
carefully composed for you.
rieren.

Hier ist unser gesamtes Match-Programm das
We are pleased that you are interested in our
wir mit sehr grosser Sorgfalt für Sie zusammen-
high tech target shooting products. This cata-
gestellt haben. Über Ihr Interesse an unseren
logue gives you a detailed overview on the
High-Tech Sportgeräten freuen wir uns.
variety of ANSCHÜTZ products and the referring
Dieser Katalog bietet Ihnen einen umfassenden
high precision accessories.
Überblick über die ANSCHÜTZ Modellvielfalt

und das dazugehörige, präzisionsorientierte
Since 1856 we have manufactured sports
Zubehör.
rifles and pistols for target shooting as well as

Seit dem Jahr 1856 stellen wir Sportgeräte
hunting rifles in the famous ANSCHÜTZ quality.
für den Schiesssport sowie Jagd- und Präzisions-
The composition of tradition and progress,
gewehre in der berühmten ANSCHÜTZ Qualität
research and development and the permanent
her. Das Zusammenspiel von Tradition und
search for new ideas produced a trend-setting
Fortschritt, Forschung und Entwicklung und die
offer of sports guns and accessories. Olympic,
kontinuierliche Suche nach immer wieder neuen
World and European Champions and the ma-
Ideen haben ein richtungsweisendes Angebot
jority of target shooters all around the world
an Sportwaffen und Zubehör entstehen lassen.
rely on ANSCHÜTZ quality.

Olympiasieger, Welt- und Europameister sowie
die Mehrzahl aller Sportschützen in der ganzen
Welt vertrauen darauf.
We wish you a lot of fun with this new catalogue.

Viel Spass mit unserem neuen Match-Katalog
wünscht Ihnen Ihr

Jochen Anschütz
Jochen Anschütz
Geschäftsführer





Der Inhalt

The Index

Match Biathlongewehre · Target Biathlon Rifles:		
Mod. 1827 Fortner	10-11	14
Mod. 64 R	12-13	14
LaserPower Biathlon Gewehr · LaserPower Biathlon Rifle:		
LaserPower Biathlon	16-18	
Match Pressluft Luftgewehre · Target Compressed Air Rifles:		
New Mod. 9003 Premium	20-23	32
New Mod. 8002 Compressed Air	24-27	32
Sport Luftgewehr · Sport Air Rifle:		
Mod. 275	28-29	
Match Pressluft Luftpistole · Target Compressed Air Pistol:		
Mod. LP - @ ANSCHÜTZ Compressed Air	30-31	
KK-Matchgewehre · Small Bore Target Rifles:		
Mod. 1903	34-35	36
Mod. 64 R Sporter Target	34-35	36
KK-Match Sportgewehre · Small Bore Target Sport Rifles:		
Mod. 1907	38-39	50
Mod. 1913 im Schaft 1907 · in stock 1907	40-41	50
Mod. 1907 im Schaft 1912 · in stock 1912	42-43	50
Mod. 1907 im Schaft 2213 Alu · in stock 2213 Alu	44-45	50
Mod. 2007/660 im Schaft 2313 Alu · in stock 2313 Alu	46-47	50
New Mod. 2007/660 „Spezial“	46-47	50
New Mod. 1907 R für CISM · for CISM	48-49	50
New Mod. 1907 R im Schaft G&E RS III für CISM · in stock G&E RS III for CISM ...	48-49<	50
KK-Super Match Freie Gewehre · Small Bore Target Free Rifles:		
Mod. 1913 „Super Match“ im Holzschaff · in wood stock	52-53	58
Mod. 1913 im Schaft 2213 Alu · in stock 2213 Alu	54-55	58
Mod. 2013/690 im Schaft 2313 Alu · in stock 2313 Alu	56-57	58
Match-Abzüge · Match Triggers:	60-62	
Zubehör-Programm · Accessories:		
Alles für das Visieren · all you need for aiming	64-68	
Alles für die Schäfte · all you need for the stocks	69-73	
Alles für Pressluft · all you need for compressed air	74	
Magazine · magazines	75	
Alles für die Balance · all you need for the balance	76-77	
Alles für die Pflege · all you need for care	78-79	
Transportkoffer, Futterale, Taschen · cases, soft cases, bags	80-82	
Bekleidung · clothing	82	
Schiessriemen · shooting slings	83	
Werbemittel, Kataloge · Marketing Material, Catalogues	83-84	
Info-Seiten · Info Pages:		
So finden Sie uns · how you find us	86	
Gratis Info Service · free-of-charge Info Service	87	
Ihre Zufriedenheit · your satisfaction	88	
Symbol-Beschreibung / Bestell-Nummern · symbol description / Item Nos.	90-93	

Individual-Programm
Individual Offer

Biathlongewehre
Biathlon Rifles

LaserPower Gewehr
LaserPower Rifle

Luftgewehre und Luftpistolen
Air Rifles and Air Pistols

KK-Matchgewehre
Small Bore Target Rifles

KK-Match Sportgewehre
Small Bore Target Sport Rifles

KK-Super Match Freie Gewehre
Small Bore Target Free Rifles

Match-Abzüge
Match Triggers

Zubehör-Programm
Accessories

Info-Seiten
Info Pages

Modell 1827 ANSCHÜTZ Fortner - *Schnelligkeit ist Trumpf*

Model 1827 ANSCHÜTZ Fortner



KK-Modell 1827 Fortner nitriert:

Biathlon fasziniert Millionen. Über 90% aller Biathleten weltweit schießen erfolgreich ein ANSCHÜTZ-Fortner Biathlon Gewehr.

System:

- Extrem kurze Schussentwicklungszeit.
- Patentierter Fortner Geradezugverschluss mit Mehrladevorrichtung.
- Match Druckpunktanzug eingestellt auf 550 g.

Lauf:

- Kältegetesteter, nitrierter Speziallauf für lange Lebensdauer.
- Spezialkorntunnel mit Schneeklappe.

Schaft:

- Leichter Spezialschaft.
- Einzigartige Kappen- und Backenverstellung.
- Profilschienen für Tragegestell und Schiessriemen.
- Magazinhalter für vier 5-Schuss Magazine.
- Spezialmagazin mit Reservebox für 3 Patronen.

Lieferumfang:

Fünf 5-Schuss Magazine 1827-U22/1, Reservebox, Ersatzschlagbolzen, Schraubendreher, Innensechskantschlüssel, Bedienungsanleitung und Original-Schussbild.

ANSCHÜTZ Dioptersatz nach Wahl, z.B. 6827 inkl. Diopter 6807 und fünf Korne. Weiteres Zubehör siehe „Zubehörprogramm“.

Weitere Modellvarianten siehe Individualprogramm. Die dort angebotenen Wechselschäfte und Wechselsysteme können kombiniert werden.

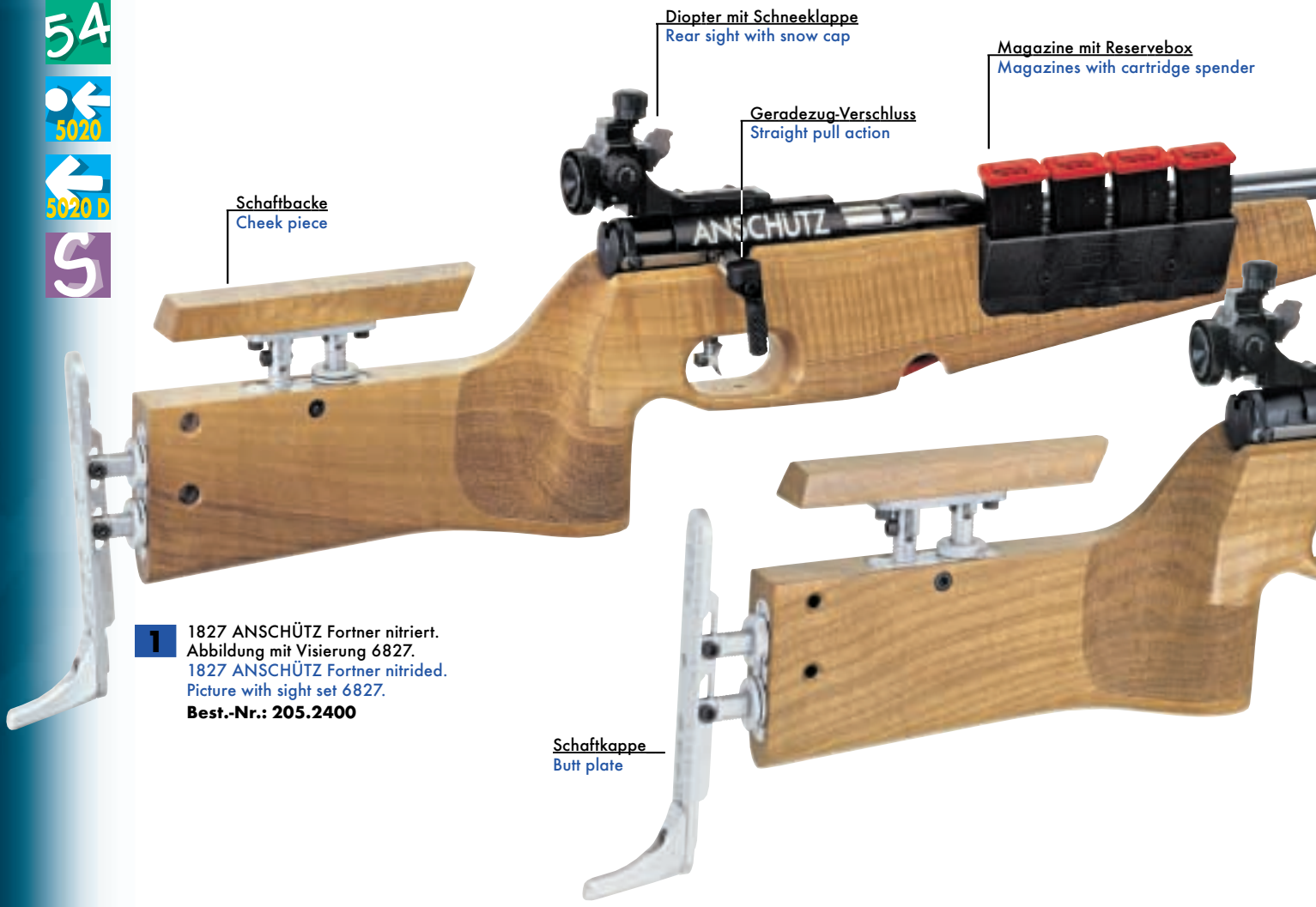
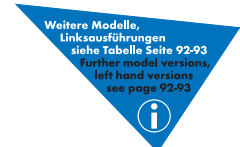

1 1827 ANSCHÜTZ Fortner nitriert. Abbildung mit Visierung 6827. 1827 ANSCHÜTZ Fortner nitrided. Picture with sight set 6827. Best.-Nr.: 205.2400



Modell 1827 Fortner Sprint nitriert:

- Extra leichtes 1827er Fortner System.
- Gewichtsreduzierung um 300 g.
- Weitere Funktionen wie 1827 Fortner nitriert.

Model 1827 Fortner Sprint nitrided:

- Extra light 1827 Fortner barreled action.
- Weight reduced by 300 g.
- Other functions equal to 1827 Fortner nitrided steel.



↑
Jetzt spezialbehandelt
Bei gekürztem Magazinschacht kann auch das gehärtete 5 Schuss Magazin 54.18 MS R-U2 verwendet werden.
Now especially treated
With shortened magazine pit also the hardened 5-shot magazine 54.18 MS R-U2 can be used.
Best.-Nr.: 700.4260



Erfolge · Results
www.anschuetz-sport.com

Small bore model 1827 Fortner nitride steel:
Biathlon fascinates millions. 90% of all biathletes worldwide shoot an ANSCHÜTZ-Fortner biathlon rifle.

Barreled action:

- Extremely short locktime.
- Patented Fortner straight pull action with repeating device.
- Match two stage trigger adjusted to 550 g.

Barrel:

- Cold-tested special nitrided steel barrel for long service life.
- Special front sight with snow cover.

Stock:

- Light special stock.
- Extraordinary butt plate and cheek piece adjustment.
- Rail for harness and target sling.
- Magazine holder for four 5-shot magazines.
- Special magazines with extra cartridge spender for 3 more rounds.

Delivered with:

Five 5-shot magazines 1827-U22/1, cartridge spender, extra firing pin, screw driver, Allan key and manual with test target.

ANSCHÜTZ sight set can be selected, e.g. **6827** incl. **rear sight 6807** and 5 inserts. Further accessories see "Accessories".

Further model versions can be selected from the components of our individual offer. The listed stocks and barreled actions can be combined.



Schneeklappe mit Gummipropfen
Snow cap with rubber plug

Korntunnel
Front sight

Nitrierter Präzisions-Matchlauf
Nitrided precision match barrel

Magazinhalter
Magazine holder

2 1827 ANSCHÜTZ Fortner Sprint nitriert. Abbildung mit Visierung 6827. 1827 ANSCHÜTZ Fortner Sprint nitrided. Picture with sight set 6827. **Best.-Nr.: 205.2920**



Sonderausführung mit Goldlauf für den dreifachen Olympiasieger Michael Greis. Special version with golden barrel for the triple Olympic Champion Michael Greis.



200 g

↑ **Laufgewicht Biathlon 4749.**
Barrel weight Biathlon 4749.
Best.-Nr.: 700.6130*



↑ **Gummipropfen, im Falle eines versehentlichen Auslösens bei verschlossener Schneeklappe.**
Rubber plug in case of inadvertent shot release at closed snow cover.



↑ **Patentierter Fortner Geradenzug-Verschuss für schnelles und zuverlässiges Repetieren.**
Patented Fortner straight pull action for fast and reliable repeating.

Modell 64 R Biathlon - *Universell einsetzbar*

Model 64 R Biathlon



KK-Modell 64 R Biathlon-Matchgewehr:

- Einsteigermodell für Sommer- und Winterbiathlon.
- Geeignet als Jugend- und Vereinsgewehr sowie für die Schiessausbildung.
- Als Rechts- und Linksgewehr lieferbar.

System:

- Kältegetesteter ANSCHÜTZ Biathlon Speziallauf.
- Matchabzug 5103 eingestellt auf 1500 g oder wahlweise Matchabzug 5104 eingestellt auf 550 g.

Schaft:

- Bucheschaft mit Profilschienen für Tragegestell und Schiessriemen.
- Schaftkappe 4709 A verstellbar in Höhe und Länge.
- Möglichkeit zur Anbringung der Gummikappe 4709 B sowie Alu-Kappen 4759 und 4758.

Lieferumfang:

Ein 5-Schuss-Magazin, Schraubendreher, Innensechskantschlüssel, Bedienungsanleitung und Original-Schussbild.

Visierung siehe Zubehör.

Weitere Modellvarianten siehe Individualprogramm. Die dort angebotenen Wechselschäfte und Wechselsysteme können kombiniert werden.

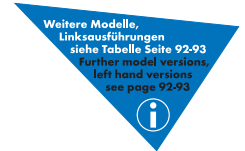

- 4** 64 R Biathlon Buche. Abbildung mit Visierung 6834. 64 R Biathlon hardwood. Picture with sight set 6834. **Best.-Nr.: 219.2003**

Small bore model 64 R Biathlon - target rifle:

- Entry model for summer and winter biathlon.
- Suitable as junior or club rifle and for shooting education.
- Available as right and left hand version.

Barreled action:

- Cold-tested ANSCHÜTZ biathlon special barrel.
- Match trigger 5103 adjusted to 1500 g or as per choice Match trigger 5104 adjusted to 550 g.

Stock:

- Hardwood stock with rails for harness and target sling.
- Butt plate 4709 A adjustable in height and length.
- Possibility to attach rubber butt plate 4709 B as well as aluminum butt plates 4759 and 4758.

Delivered with:

One 5 shot magazine, screw driver, Allan key and manual with test target.

Sight sets see Accessories.

Further model versions can be selected from the components of our individual offer. The listed stocks and barreled actions can be combined.



↑
Jetzt spezialbehandelt
Bei gekürztem Magazinschacht kann auch das gehärtete 5 Schuss Magazin 54.18 MS R-U2 verwendet werden.
Now especially treated
With shortened magazine pit also the hardened 5-shot magazine 54.18 MS R-U2 can be used.
Best.-Nr.: 700.4260

More Information

www.anschuetz-sport.com



↑
Magazinhalter 1927-U23 für 4 Magazine, passend für Modelle 64 R Biathlon und 1827 ANSCHÜTZ Fortner.
Magazine holder 1927-U23 for 4 magazines, suitable for models 64 R Biathlon and 1827 ANSCHÜTZ Fortner.

Best.-Nr.: 700.3320



↑
Alu-Profilschiene für Tragegestell.
Alu-grooved rail for harness.



Gummipropfen, im Falle eines versehentlichen Auslösens bei verschlossener Schneeklappe.
Rubber plug in case of inadvertent shot release at closed snow cover.

↑
Schneeklappe.
Snow cover.
Best.-Nr.: 700.3115

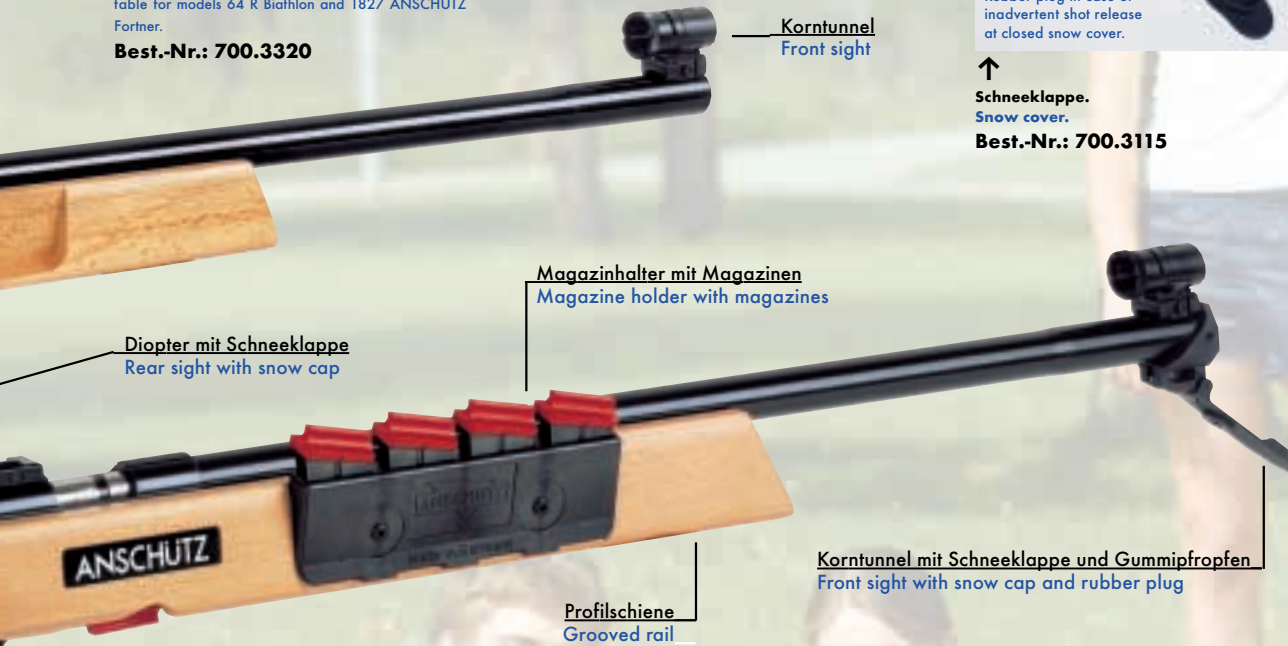

Korntunnel
Front sight

Magazinhalter mit Magazinen
Magazine holder with magazines

Dioptr mit Schneeklappe
Rear sight with snow cap

Korntunnel mit Schneeklappe und Gummipropfen
Front sight with snow cap and rubber plug

Profilschiene
Grooved rail

- 5** 64 R Biathlon Buche, verstellbare Backe.
Abbildung mit möglichem Sonderzubehör
(Visierung, Schneeklappe, Magazine
und Magazinhalter).
64 R Biathlon hardwood, adjustable cheek piece.
Picture with possible special accessories (sight set,
snow cover, magazines and magazine holder).
Best.-Nr.: 219.3002



- ① **Gummikappe 4709B-U1**, gewölbt.
Rubber butt plate 4709B-U1, convex.
Best.-Nr.: 710.3710
- ② **Gummikappe 4709A-U1**, gerade.
Rubber butt plate 4709A-U1, straight.
Best.-Nr.: 710.3700
- ③ **Führungsplatte 4709A-U2/1**,
komplett für Gummikappe
Guide plate 4709A-U2/1,
complete for rubber butt plate.
Best.-Nr.: 710.3715
- ④ **Zwischenplatte 4709P**, parallel 8 mm.
Spacer 4709P, parallel 8 mm.
Best.-Nr.: 710.3750

Das Individual-Programm

The Individual Offer

Unsere Wechselsysteme bieten mehrere Kombinationsmöglichkeiten mit Wechselschäften. Linksausführungen sind mit **L** gekennzeichnet.

Our barreled actions can be combined with various stocks. The models marked with **L** are available in left hand version.

1827 Fortner „Biathlon“



1827 Fortner - U4 „Biathlon“



L 1827L Fortner - U5 „Biathlon“

Best.-Nr. Item No.	Modell Model	Hinweis Note	Kaliber Caliber	Geschossführung/Lauflänge Rifling/Barrel length	Gewicht ca. Weight approx.
205.2490 205.2940	1827 F-U4 1827 F-U4	Fortner, nitrierter Lauf · Fortner, nitrided steel barrel Fortner Sprint, nitrierter Lauf · Fortner Sprint, nitrided steel barrel	.22 l.r. .22 l.r.	55 cm / 55 cm · 21.6" / 21.6" 55 cm / 55 cm · 21.6" / 21.6"	2,3 kg / 5.0 lbs 2,1 kg / 4.6 lbs
205.3980	1827L F-U5	Fortner Sprint, nitrierter Lauf Fortner Sprint, nitrided steel barrel	L .22 l.r.	55 cm / 55 cm · 21.6" / 21.6"	2,1 kg / 4.6 lbs



Best.-Nr. Item No.	Modell Model	Hinweis Note
705.0523	1927 F-8000	Nuss natur · Walnut non-stained
705.0524	1927FL-8000	Nuss natur · Walnut non-stained L



64 R-U2

64 R „Biathlon“

Best.-Nr. Item No.	Modell Model	Hinweis Note	Kaliber Caliber	Geschossführung/Systemlänge Rifling/Barrel length	Gewicht ca. Weight approx.
219.2690* 219.2890	64 R-U2 64 R-U2	Druckpunktanzug · two stage trigger 5104 / 550 g Druckpunktanzug · two stage trigger 5103 / 1500 g	.22 l.r. .22 l.r.	54 cm / 69 cm · 21.2" / 27.2" 54 cm / 69 cm · 21.2" / 27.2"	2,5 kg / 5.5 lbs 2,5 kg / 5.5 lbs
219.2990	64L R-U2 links	Druckpunktanzug · two stage trigger 5103L / 1500 g	L .22 l.r.	54 cm / 69 cm · 21.2" / 27.2"	2,5 kg / 5.5 lbs



Best.-Nr. Item No.	Modell Model	Hinweis Note
705.0292	64 R-U60	Buche / Hardwood



Best.-Nr. Item No.	Modell Model	Hinweis Note
705.0295	64 R-U50	Buche mit verstellbarer Backe / Hardwood with adjustable cheek piece
705.0296	64L R-U50	Buche links mit verstellbarer Backe / Hardwood left with adjustable cheek piece L

LaserPower Gewehr
LaserPower Rifle



Modell LaserPower Biathlon - für Spass, Sport & Events

Model LaserPower Biathlon



Modell LaserPower Biathlon:

- Gefahrlose Lasertechnologie Klasse 1.
- Kein Gewehr im Sinne des Waffengesetzes.
- Für alle Altersgruppen geeignet.
- Für freizeithliche Sommer- und Winterbiathlonwettkämpfe.
- Als PR Attraktion für Messen und Events aller Art.

Ausstattung:

- Rechts-/Linksschaft in Buchenausführung.
- Maximalgewicht nur 2,2 kg.
- Einfache Dioptervisierung.
- Druckpunkt abzug 5066.
- Batterie- oder akkubetriebene Laservorrichtung.
- Biathlonziel mit 5 Trefferscheiben.
- Optional Duell-Software mit Zeitauswertung.

Lieferumfang:

Visierung, 2 x Zwischenplatten 4709 P, Biathlonziel, Zielreduzierung Biathlon, Fernbedienung, Batterien und Beipack.

Model LaserPower Biathlon:

- Risk-free laser technology class 1.
- Not restrictive with regard to firearms laws.
- Suitable for all age groups.
- For summer and winter biathlon events.
- As PR attraction for all kinds of shows and events.

Equipment:

- Right/left stock in hardwood version.
- Max. weight of only 2.2 kg.
- Easy to operate sight set.
- Two stage trigger 5066.
- Battery or accumulator operated laser device.
- 5 electronic panel biathlon target.
- Optionally with duell software with time results.

Delivered with:

Sight set, 2 x spacer 4709 P, biathlon target, panel reducer biathlon, remote control, batteries and spare parts.



↑
Zielfernrohr 4 x 20.
Telescopic sight 4 x 20.
Best.-Nr.: 716.1003



Gummikappe, verstellbar
Rubber butt plate, adjustable

Führungsplatte
Guide plate

Ladeknopf
loading knob

Diopter
Rear sight

Sicherung
Safety

Abzug 5066
Trigger 5066

Bucheschaft in neuem Design
Hardwood stock in new design

8

LaserPower Biathlon komplett mit Biathlonziel Batterien und Beipack.
LaserPower Biathlon, complete with biathlon target, panel reducer Biathlon, batteries, tools and spare parts.
Best.-Nr.: 716.0000

Fernbedienung
Remote control





↑
Rotpunkt Visier 1 x 20.
Red dot sight 1 x 20.
Best.-Nr.: 716.1002



↑
Präzisionsdiopter 6809.
Rear sight 6809.
Best.-Nr.: 700.0114



Laufmantel
Barrel unit

Korntunnel
Front sight

Lasereinheit
Laser unit

NEW

- Blitzlichtsicher
- Vorbereitet für Duell-Version
- Flashlight resistant
- Prepared for duel version

5-Scheiben Biathlonziel
5 Panel biathlon target

Infrarotempfänger
Infrared receiver



Batteriefach
Battery compartment

Batteriefach
Battery compartment



Zielreduzierung
Panel reducer

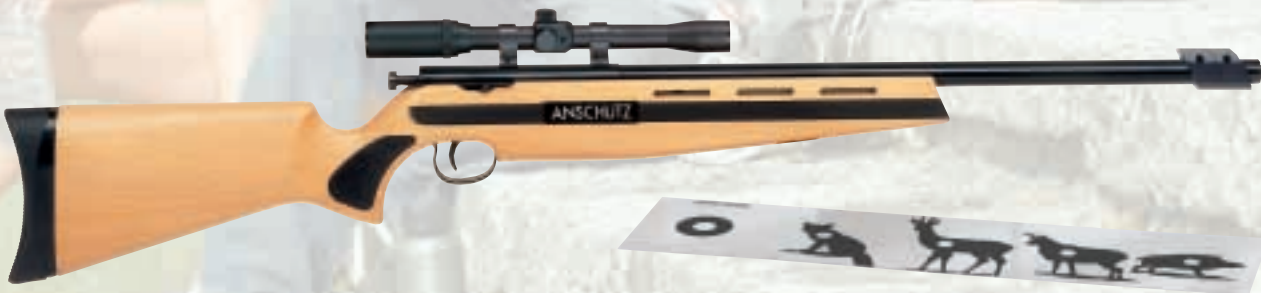

Filme · Movies

www.anschutz-sport.com

9 LaserPower Jagd komplett mit Zielfernrohr, Biathlonziel, Zielreduzierung Jagd, Zielreduzierung Biathlon, 2 Laufgewichte, Fernbedienung, Batterien und Beipack.
LaserPower Hunting, complete with telescopic sight, biathlon target, panel reducer hunting, panel reducer biathlon, 2 barrel weights, remote control, batteries and spare parts.
Best.-Nr.: 716.0004

Modell LaserPower Biathlon

Model LaserPower Biathlon

Visierungen, Handstopps, Laufgewichte, Gummi- und Aluschaffkappen siehe Zubehör.

Sight sets, handstops, weights, rubber- and alu butt plates see Accessories.



① Gummikappe 4709A-U1, gerade.
Rubber butt plate 4709 A-U1, straight.
Best.-Nr.: 710.3700

④ Fernbedienung, einzeln.
Remote control.
Best.-Nr.: 716.1001

⑦ Zielreduzierung Jagd, einzeln.
Panel reducer hunting.
Best.-Nr.: 716.1004

⑩ Rotpunkt Visier 1 x 20.
Red dot sight 1 x 20.
Best.-Nr.: 716.1002

② Zwischenplatte 4709P, parallel 8 mm.
Spacer 4709P, parallel 8 mm.
Best.-Nr.: 710.3750

④ + ⑤ + ⑥ LaserPower Ziel, einzeln.
LaserPower panel.
Best.-Nr.: 716.0002

⑧ LaserPower Stativ.
LaserPower tripod.
Best.-Nr.: 716.1005

⑪ Netzteil für Biathlonziel.
Mains apparatus for biathlon target.
Best.-Nr.: 716.1000

③ LaserPower Gewehr, einzeln.
LaserPower Rifle.
Best.-Nr.: 716.0001

⑥ Zielreduzierung Biathlon, einzeln.
Panel reducer Biathlon.
Best.-Nr.: 008202

⑨ Zielfernrohr 4 x 20.
Telescopic sight 4 x 20.
Best.-Nr.: 716.1003

⑫ LaserPower Dualus-Kabel, inkl. Software (ab Version 1.5).
LaserPower dualus cable incl. software (starting from version 1.5).
Best.-Nr.: 716.1006

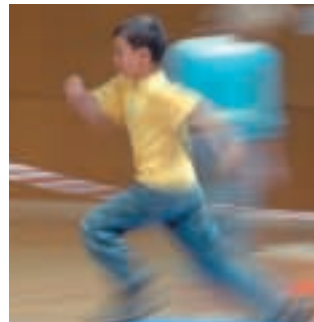

Luftgewehre und Luftpistolen
Air Rifles and Air Pistols



Modell 9003 Premium - setzt Massstäbe im Spitzensport

Model 9003 Premium



LG Modell 9003 Premium:
Spitzenprodukt aus dem Hause ANSCHÜTZ.
Innovativ und mit allen Finessen der modernen Technik.

System:

- Entkoppelte und schwingungsdämpfende Systembefestigung über Soft-Link®.
- Wartungsfreier Stabilisator.
- Revolutionäres Schlagbolzen- und Ventilsystem für noch ruhigere Schussabgabe.
- Optimiertes Strömungsverhalten.
- Rückstoss- und erschütterungsfreies Pressluftsystem.
- Extrem kurze Schussentwicklungszeit.
- Extrem feineinstellbarer Match-Abzug.
- Optimierter Spannvorgang.
- Spezialkonzept für Trockentraining und Sicherung.

- Patentierter Luftfilter gegen Verunreinigungen.
- Wartungsfreundliche Gesamtkonzeption.
- Leicht auswechselbare Pressluftkartusche mit Manometer.
- Vielseitig verstellbares Abzugszügel.
- Spannhebel links und rechts montierbar.

- Vielseitig verstellbarer Pistolengriff.
- Komplett mit PRO-Grip Ausstattung.
- Dekoraufkleber zur individuellen Schaftgestaltung.

Lieferumfang:

Kunststoff-Gewehrkoffer, Zubehörbox mit folgendem Inhalt: Soft Link® Systemverbindung, Zusatzgewichte, Visierlinienerhöhung, Fülladapter mit Ablassschraube, Entlüftungsbuchse, Spezialfett, Innensechskantschlüssel, Bedienungsanleitung mit Original-Schussbild, Service-Nachweisheft und Design-Aufkleber.

Schaft:

- Geschränkter Aluminiumschaft.
- Vorderschaft verschiebbar, verstellbar in Höhe und Neigung zur optimalen Anpassung an den Körper.

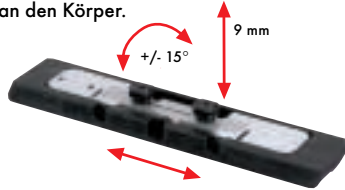

Weitere Modelle, Linksausführungen siehe Tabelle Seite 92-93
 Further model versions, left hand versions see page 92-93

More Information
www.anschuetz-sport.com

Air rifle model 9003 Premium:
Top class ANSCHÜTZ product.
Innovative and with all features of modern technology.

Barellled action:

- Tension free and vibration damping barrel/stock connection through Soft-Link®.
- Maintenance free stabilizer.
- Revolutionary firing pin and valve system for even calmer shot release.
- Optimised flow behaviour.
- Recoil and vibration free compressed air barreled action.
- Extremely short lock time.

- Precisely adjustable match trigger.
- Optimised cocking.
- Special concept for dry firing and safety.
- Patented air filter against pollutions.
- Maintenance-friendly system.
- Easily exchangeable compressed air cylinder with manometer.
- Adjustable trigger blade.
- Cocking lever mountable left and right.

- Completely with PRO-Grip equipment.
- Decoration stickers for individual stock design.

Delivered with:

Plastic rifle case contains, accessory box with: Soft Link® shock absorber pads, additional weights, sight raiser block, filling adapter, air release screw, special grease, Allan key, instruction leaflet with original test target, service manual and stock design stickers.

Stock:

- Crossed aluminum stock.
- Fore-end adjustable in height, length and angle for optimum adaptation to the body.
- Adjustable pistol grip.



Dieses Symbol zeigt Ihnen die vielseitigen Möglichkeiten der Balanceveränderung mit original ANSCHÜTZ Zubehör.

This sign shows you the multiple possibilities of adjusting the balance with the help of original ANSCHÜTZ accessories.

NEW Neue schwingungsoptimierte Version
New optimised vibration version

Präzisions-Matchlauf
Precision match barrel

2-teiliges Laufgewicht 4745, 50 g
2-piece barrel weight 4745, 50 g



Laufgewicht 68 g
Barrel weight 68 g



Korntunnel
Front sight

Visierlinienerhöhung
Sight raiser block

Pressluftkartusche mit Manometer
Compressed air cylinder with manometer

Alu-Systemträger
Aluminum carrier

Verstellbarer Vorderschaft
Adjustable fore-end stock

10 9003 Premium mit Alu-Schaftkappe 4759.
Abbildung mit Visierung 7020.
9003 Premium with aluminum butt plate 4759.
Picture with sight set 7020.
Best.-Nr.: 560.4990 Griffgröße L · Grip size L



50 g

↑
Laufgewicht 4745, 50 g, 2-teilig,
Innen-Ø 20 mm.
Two part barrel weight 4745, 50 g,
inner Ø 20 mm.
Best.-Nr.: 700.6340*



100 g

↑
Schwere Stahlsäulen, ca. 100 g, für Backen-
verstellung, 71 mm lang.
Heavy steel columns, approx. 100 g, for
cheek piece adjustment, 71 mm long.
Best.-Nr.: 700.6337



100 g

↑
Schwere Stahlsäulen, ca. 100 g, für Kappen-
verstellung, 71 mm lang.
Heavy steel columns, approx. 100 g, for butt
plate adjustment, 71 mm long.
Best.-Nr.: 700.6338

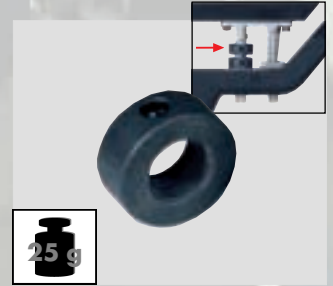

25 g

↑
Gewichtsring 4742, 25 g,
Innen-Ø 12 mm.
Weight 4742, 25 g, inner Ø 12 mm.
Best.-Nr.: 711.3805

Lieferumfang:
Delivered with:



Stabiler Gewehrkoffer
Stable gun case

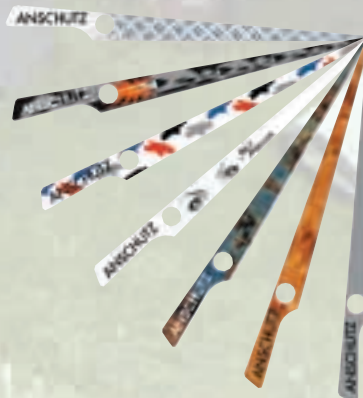

Design-Aufkleber
Design stickers

Zubehörbox
Accessory box

*Nur solange Vorrat reicht · As long as available.

Modell 9003 Premium AUFLAGE

Model 9003 Premium BENCHREST



LG Modell 9003 Premium Auflage: Die Premiumvariante für das Auflageschiessen.

System:

- Entkoppelte und schwingungsdämpfende Systembefestigung über Soft-Link®.
- Wartungsfreier Stabilisator.
- Revolutionäres Schlagbolzen- und Ventilsystem für noch ruhigere Schussabgabe.
- Optimiertes Strömungsverhalten.
- Rückstoss- und erschütterungsfreies Pressluftsystem.
- Extrem kurze Schussentwicklungszeit.
- Extrem feineinstellbarer Match-Abzug.
- Optimierter Spannvorgang.
- Spezialkonzept für Trockentraining und Sicherung.
- Patentierter Luftfilter gegen Verunreinigungen.

- Wartungsfreundliche Gesamtkonzeption.
- Leicht auswechselbare Pressluftkartusche mit Manometer.
- Vielseitig verstellbares Abzugszüngel.
- Spannhebel links und rechts montierbar.

Schaft:

- Geschänkter Aluminiumschaft.
- Verstellbarer Buche Auflage-Vorderschaft.
- Vielseitig verstellbare Schaftbacke und Pistolengriff in PRO-Grip.
- Dekoraufkleber zur individuellen Schaftgestaltung.

Lieferumfang:

Kunststoff-Gewehrkofter, Zubehörbox mit folgendem Inhalt: Soft Link® Systemverbindung, Zusatzgewichte, Visierverlängerung, Fülladapter mit Ablassschraube, Entlüftungsbuchse, Spezialfett, Innensechskantschlüssel, Bedienungsanleitung mit Original-Schussbild, Service-Nachweisheft und Design-Aufkleber.

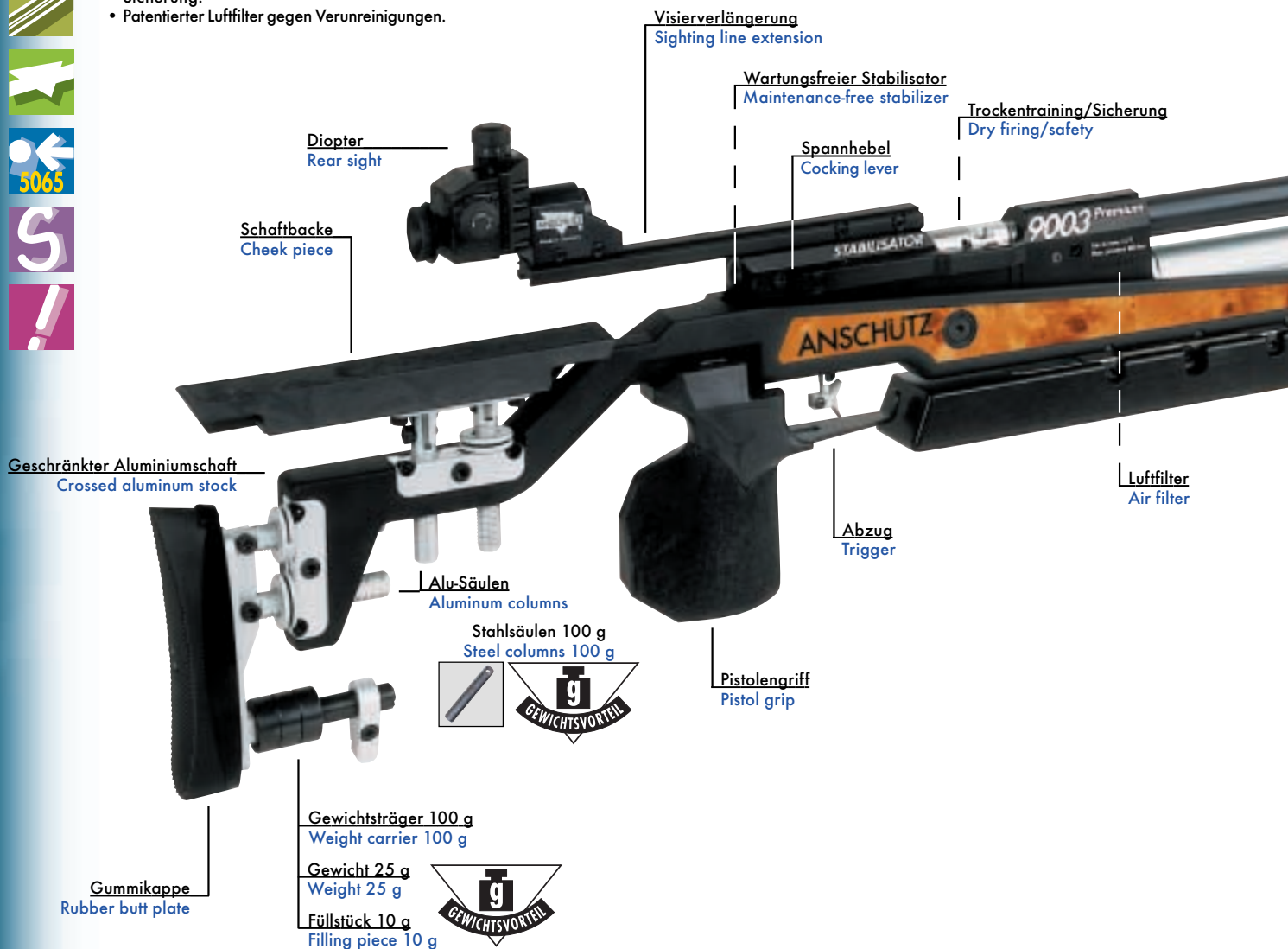
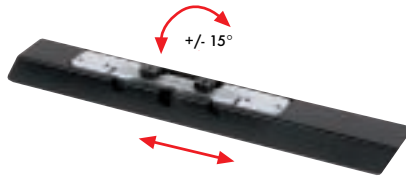

Air rifle model 9003 Premium: The Premium version for Benchrest shooting.

Barrelled action:

- Tension free and vibration damping barrel/stock connection through Soft-Link®.
- Maintenance free stabilizer.
- Revolutionary firing pin and valve system for even calmer shot release.
- Optimised flow behaviour.
- Recoil and vibration free compressed air barreled action.
- Extremely short lock time.
- Precisely adjustable match trigger.

- Optimised cocking.
- Special concept for dry firing and safety.
- Patented air filter against pollutions.
- Maintenance-friendly system.
- Easily exchangeable compressed air cylinder with manometer.
- Adjustable trigger blade.
- Cocking lever mountable left and right.

Stock:

- Crossed aluminum stock.
- Adjustable hardwood fore-end raiser block.
- Adjustable PRO-Grip cheek piece and pistol grip.
- Decoration stickers for individual stock design.

Delivered with:

Plastic rifle case contains, accessory box with: Soft Link® shock absorber pads, additional weights, sighting line extension, filling adapter, air release screw, special grease, Allan key, instruction leaflet with original test target, service manual and stock design stickers.

Weitere Modelle,
Linksausführungen
siehe Tabelle Seite 92-93
Further model versions,
left hand versions
see page 92-93





Dieses Symbol zeigt Ihnen die vielseitigen Möglichkeiten der Balanceveränderung mit original ANSCHÜTZ Zubehör.

This sign shows you the multiple possibilities of adjusting the balance with the help of original ANSCHÜTZ accessories.

NEW Neue schwingungsoptimierte Version
New optimised vibration version

Präzisions-Matchlauf
Precision match barrel

2-teiliges Laufgewicht 4745, 50 g
2-piece barrel weight 4745, 50 g



Vorderes Laufgewicht 68 g
Front barrel weight 68 g



Korn-tunnel
Front sight

Pressluftkartusche mit Manometer
Compressed air cylinder with manometer

12 9003 Premium AUFLAGE mit Gummikappe 4709 A.
Abbildung mit Visierung 7020 und Visierv-
längerung 200 mm.
9003 Premium BENCHREST with rubber
butt plate 4709 A.
Picture with sight set 7020 and sighting
line extension 200 mm.
Best.-Nr.: 560.4940 Griffgröße L · Grip size L

Alu-Systemträger
Aluminum carrier

Verstellbarer Auflage-Vorderschaft
Adjustable benchrest fore-end stock



50 g
↑
Laufgewicht 4745, 50 g, 2-teilig,
Innen-Ø 20 mm.
Two part barrel weight 4745, 50 g,
inner Ø 20 mm.
Best.-Nr.: 700.6340 *



100 g
↑
Schwere Stahlsäulen, ca. 100 g, für Backen-
verstellung, 71 mm lang.
Heavy steel columns, approx. 100 g, for
cheek piece adjustment, 71 mm long.
Best.-Nr.: 700.6337



100 g
↑
Schwere Stahlsäulen, ca. 100 g, für Kappen-
verstellung, 71 mm lang.
Heavy steel columns, approx. 100 g, for butt
plate adjustment, 71 mm long.
Best.-Nr.: 700.6338

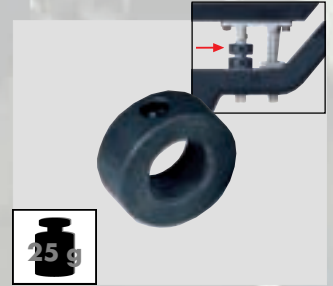

25 g
↑
Gewichtsring 4742, 25 g,
Innen-Ø 12 mm.
Weight 4742, 25 g, inner Ø 12 mm.
Best.-Nr.: 711.3805

Lieferumfang:
Delivered with:



Stabiler Gewehr-koffer
Stable gun case

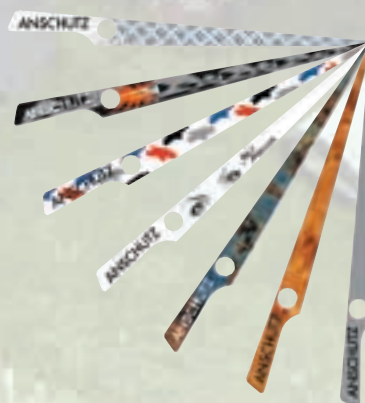

Design-Aufkleber
Design stickers

Zubehörbox
Accessory box

*Nur solange Vorrat reicht · As long as available.

Modell 8002 Pressluft - die jüngste technische Revolution

Model 8002 Compressed Air



LG Modell 8002:

Nachfolgemodell der Serie 2002 Pressluft. Ein Gewehr nach dem neuesten Stand der Technik, das allen modernen Wettkampfanforderungen entspricht.

System:

- Revolutionäres Schlagbolzen- und Ventilsystem für noch ruhigere Schussabgabe.
- Optimiertes Strömungsverhalten.
- Rückstoss- und erschütterungsfreies Pressluftsystem.
- Extrem kurze Schussentwicklungszeit.
- Extrem feineinstellbarer Match-Abzug.
- Optimierter Spannvorgang.
- Spezialkonzept für Trockentraining und Sicherung.
- Patentierter Luftfilter gegen Verunreinigungen.
- Wartungsfreundliche Gesamtkonzeption.
- Leicht auswechselbare Pressluftkartusche mit Manometer.
- Vielseitig verstellbares Abzugszüngel.
- Spannhebel links und rechts montierbar.

Schaft:

- Anatomisch perfekte Schäfte mit vibrationsabsorbierenden Elastomeren.
- Vielseitig verstellbare Schaftkappen- und Backenverstellung.
- Vielseitig verstellbarer Pistolengriff.
- Diverse Gewichte zur Einstellung der Balance.
- Aluschaft wahlweise in Rechts- oder Linksausführung, Griff, Backe und Vorderschaftserhöhung aus rutschfestem PRO-Grip Material.
- PRO-Grip Material mit Schmirgelpapier individuell bearbeitbar.
- Verschiedene Schaftvarianten.

Lieferumfang:

Modell 8002 Aluschaft:

Zubehör-Box mit Entlüftungsbuchse, Fülladapter mit Ablassschraube, Visierlinienerhöhung, Spezialfett 4425, Innensechskantschlüssel (5 Stück), Sicherungsscheiben, O-Ringe, Laufgewicht und Schiebegewichte (2 Stück unter der Vorderschaftserhöhung), Bedienungsanleitung mit Original-Schussbild.

2-teiliges Laufgewicht 4745, 50 g
2-piece barrel weight 4745, 50 g

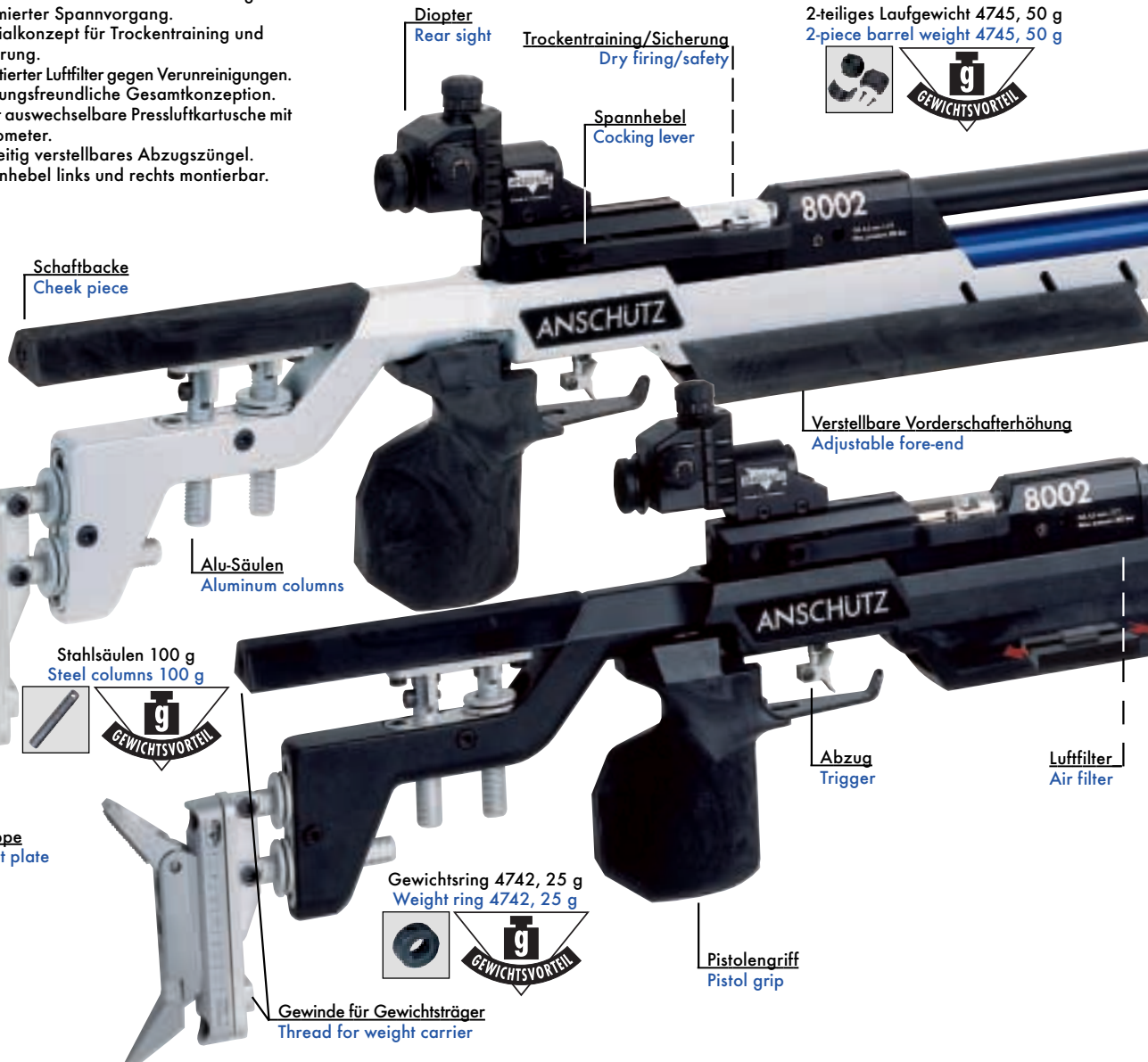

Diopter
Rear sight

Trockentraining/Sicherung
Dry firing/safety

Spannhebel
Cocking lever

Schaftbacke
Cheek piece

Verstellbare Vorderschaftserhöhung
Adjustable fore-end

Alu-Säulen
Aluminum columns

Stahlsäulen 100 g
Steel columns 100 g



Abzug
Trigger

Luftfilter
Air filter

Alu-Schaftkappe
Aluminum butt plate

Gewichtsring 4742, 25 g
Weight ring 4742, 25 g



Pistolengriff
Pistol grip

Gewinde für Gewichtsträger
Thread for weight carrier

Successor of the series 2002 Compressed Air.

A rifle according to state-of-the-art technology, that meets all modern competition requirements.

Barreled action:

- Revolutionary firing pin and valve system for even calmer shot release.
- Optimised flow behaviour.
- Recoil and vibration free compressed air barreled action.
- Extremely short lock time.
- Precisely adjustable match trigger.
- Optimised cocking.
- Special concept for dry firing and safety.
- Patented air filter against pollutions.
- Maintenance-friendly system.

- Easily exchangeable compressed air cylinder with manometer.
- Adjustable trigger blade.
- Cocking lever mountable left and right.

Stock:

- Anatomically perfect stocks with vibration absorbing elastomers.
- Multiply adjustable aluminum butt plate and cheek piece adjustment.
- Multiply adjustable pistol grip.
- Various weights to adjust the balance.
- Aluminum stock in right or left hand version, grip, cheek piece and fore-end of antiskid PRO-Grip material.
- PRO-Grip material to be adapted with fine, abrasive paper.
- Various stock types.

Delivered with:

Modell 8002 aluminum stock:

Accessory box with filling adapter, air release screw, sight raiser block, special grease 4425, Allan key (5 pieces), safety discs, o-rings, barrel weight and moveable weights (2 pieces under the fore-end raiser block), manual with original test target.

Weitere Modelle,
Linksausführungen
siehe Tabelle Seite 92-93
Further model versions,
left hand versions
see page 92-93





PRO-Grip Material mit Schmirgelpapier individuell bearbeitbar.
PRO-Grip material to be adapted with fine, abrasive paper.



Dieses Symbol zeigt Ihnen die vielseitigen Möglichkeiten der Balanceveränderung mit original ANSCHÜTZ Zubehör.
This sign shows you the multiple possibilities of adjusting the balance with the help of original ANSCHÜTZ accessories.



↑
Stabilisator, für 9003/8002.
Stabilizer, for 9003/8002.
Best.-Nr.: 700.6342

NEW Neue Farbe
New color

Präzisions-Matchlauf
Match barrel



Pressluftkartusche mit Manometer
Compressed air cylinder with manometer

Korntunnel
Front sight

16 8002 Pressluft Alu, silber/schwarz mit Alu-Schaftkappe 4759. Abbildung mit Visierung 7020.
8002 Compressed Air aluminum, silver/black with aluminum butt plate 4759. Picture with sight set 7020.
Best.-Nr.: 560.2932 Griffgröße L · Grip size L

Laufgewicht 68 g
Barrel weight 68 g



Alu-Schaft
Aluminum stock

18 8002 Pressluft Alu, schwarz/schwarz mit Alu-Schaftkappe 4759. Abbildung mit Visierung 7020.
8002 Compressed Air aluminum, black/black with aluminum butt plate 4759. Picture with sight set 7020.
Best.-Nr.: 560.2935 Griffgröße L · Grip size L



Schiebewichte (2 Stück) je 180 g
Moveable weights (2 pieces) 180 g each



100 g

↑
Gewichtsträger, für 9003/8002 Kappenausleger und Schaftbacken, ca. 100 g.
Weight carrier, for 9003/8002 hook plate carrier and cheek piece approx. 180 g.
Best.-Nr.: 007557



25 g

↑
Gewichtsring 4742, 25 g, Innen-Ø 12 mm.
Weight 4742, 25 g, inner Ø 12 mm.
Best.-Nr.: 711.3805



50 g

↑
Laufgewicht 4745, 50 g, 2-teilig, Innen-Ø 20 mm.
Two part barrel weight 4745, 50 g, inner Ø 20 mm.
Best.-Nr.: 700.6340



100 g

↑
Schwere Stahlsäulen, ca. 100 g, für Backenverstellung, 71 mm lang.
Heavy steel columns, approx. 100 g, for cheek piece adjustment, 71 mm long.
Best.-Nr.: 700.6337



100 g

↑
Schwere Stahlsäulen, ca. 100 g, für Kappenverstellung, 71 mm lang.
Heavy steel columns, approx. 100 g, for butt plate adjustment, 71 mm long.
Best.-Nr.: 700.6338

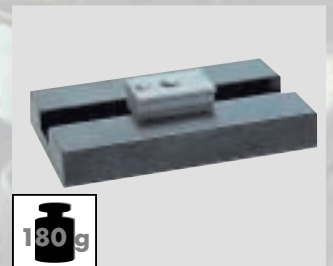

180 g

↑
Zusatzschiebeweight, für Aluminiumprofilschiene, ca. 180 g.
Sliding weight, approx. 180 g, for aluminum rail.
Best.-Nr.: 700.6343

*Nur solange Vorrat reicht · As long as available.

Modell 8002 Pressluft - die jüngste technische Revolution

Model 8002 Compressed Air



Lieferumfang:

Modell 8002 AUFLAGE:

Wie beim Aluschaft, jedoch mit Visierverlängerung anstatt Visierlinienerhöhung und ohne Schiebengewichte.

Modell 8002 JUNIOR:

Inkl. Visierung, Fülladapter mit Ablassschraube, Entlüftungsbuchse, Innensechskantschlüssel (5 Stück), O-Ringe, Bedienungsanleitung mit Original-Schussbild.

Modell 8002 VEREIN:

Inkl. Visierung, Fülladapter mit Ablassschraube, Entlüftungsbuchse, Innensechskantschlüssel (5 Stück), O-Ringe, Laufgewicht, lange Alu-Säulen, Bedienungsanleitung mit Original-Schussbild.

Modell 8002 BUNT:

Wie beim Aluschaft, jedoch ohne Schiebengewichte und ohne Visierlinienerhöhung.

Modell 8002 LIGHT:

Wie beim Aluschaft, jedoch ohne Schiebengewichte.

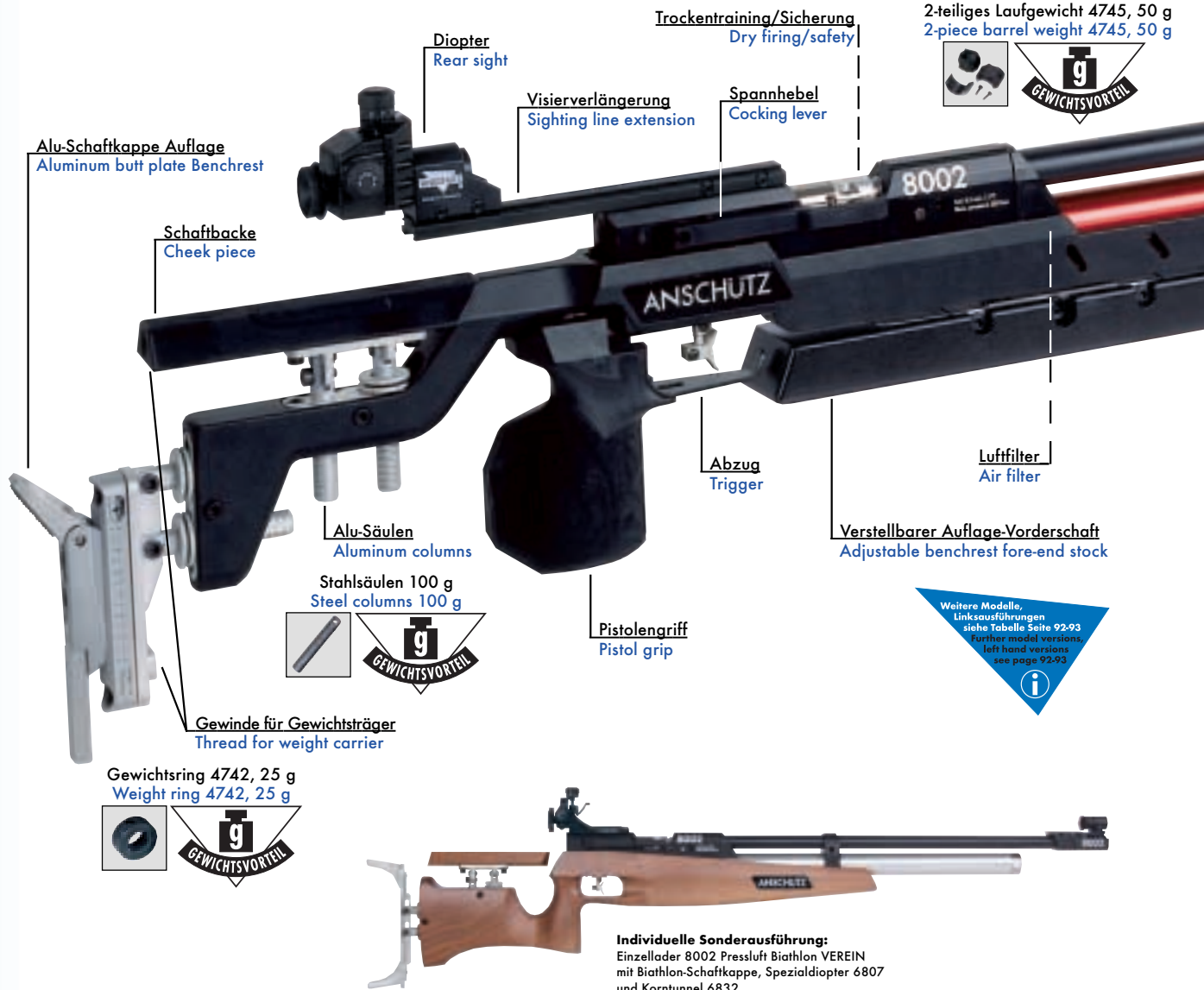
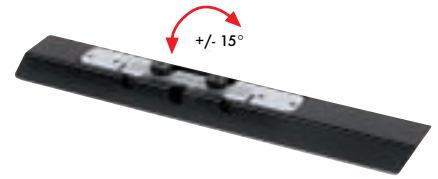

Individuelle Sonderausführung:

Einzellader 8002 Pressluft Biathlon VEREIN mit Biathlon-Schaftkappe, Spezialdioptr 6807 und Korntunnel 6832.

Special production:

Single loader 8002 Compressed Air Biathlon CLUB with biathlon butt plate, special rear sight 6807 and front sight 6832.

Delivered with:

Modell 8002 BENCHREST:

Like for aluminum stock but with sighting line extension instead of sight raiser block and without moveable weights.

Modell 8002 JUNIOR:

Incl. sight set, filling adapter, air release screw, Allan key (5 pieces), o-rings, manual with original test target.

Modell 8002 CLUB:

Incl. sight set, filling adapter, air release screw, Allan key (5 pieces), o-rings, barrel weight, long aluminum columns, manual with original test target.

Modell 8002 COLOR:

Like for aluminum stock but without moveable weights and without sight raiser block.

Modell 8002 LIGHT:

Like for aluminum stock but without moveable weights.

More Information

www.anschuetz-sport.com



Dieses Symbol zeigt Ihnen die vielseitigen Möglichkeiten der Balanceveränderung mit original ANSCHÜTZ Zubehör.

This sign shows you the multiple possibilities of adjusting the balance with the help of original ANSCHÜTZ accessories.

Präzisions-Matchlauf
Precision match barrel

Vorderes Laufgewicht 68 g
Front barrel weight 68 g



Korn-tunnel
Front sight

Pressluftkartusche mit Manometer
Compressed air cylinder with manometer

- 22** 8002 Pressluft AUFLAGE mit Alu-Schaftkappe 4759A (Auflage).
Abbildung mit Visierung 7020 und Visierverlängerung 200 mm.
8002 Compressed Air BENCHREST with butt plate 4759A.
Picture with sight set 7020 and Sighting line extension 200 mm.
Best.-Nr.: 560.2940 Griffgröße L · Grip size L

Alu-Schaft
Aluminum stock



- 24** 8002 Pressluft Nuss AUFLAGE mit Alu-Schaftkappe 4759A (Auflage).
Abbildung mit Visierung 7020 und Visierverlängerung 200 mm.
8002 Compressed Air Walnut BENCHREST with aluminum butt plate 4759A.
Picture with sight set 7020 and Sighting line extension 200 mm.
Best.-Nr.: 560.2942



- 14** 8002 Pressluft JUNIOR mit Alu-Schaftkappe 4758.
Lieferung inkl. Visierung 6834.
8002 Compressed Air JUNIOR with aluminum butt plate 4758.
Incl. sight set 6834. **Best.-Nr.: 560.2902**



- 15** 8002 Pressluft VEREIN mit Alu-Schaftkappe 4758.
Lieferung inkl. Visierung 6834.
8002 Compressed Air CLUB with aluminum butt plate 4758.
Incl. sight set 6834. **Best.-Nr.: 560.2910**



- 26** 8002 Pressluft BUNT mit Alu-Schaftkappe 4759.
Abbildung mit Visierung 6834.
8002 Compressed Air COLOR with aluminum butt plate 4759.
Picture with sight set 6834. **Best.-Nr.: 560.2955**

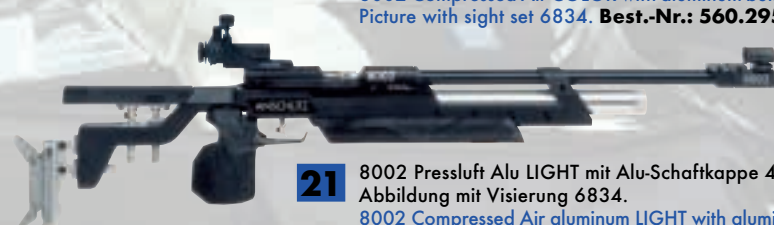

- 21** 8002 Pressluft ALU LIGHT mit Alu-Schaftkappe 4759.
Abbildung mit Visierung 6834.
8002 Compressed Air aluminum LIGHT with aluminum butt plate 4759.
Picture with sight set 6834. **Best.-Nr.: 560.2937***
Griffgröße M · Grip size M

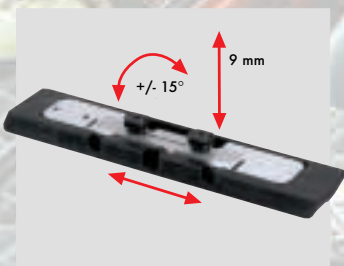

↑
Vorderschafterhöhung 4860,
PRO-Grip, 20 mm hoch, 248 mm lang.
Fore-end raiser block 4860,
PRO-Grip, 20 mm high, 248 mm long.
Best.-Nr.: 700.3631 Schwarz/black

*Nur solange Vorrat reicht · As long as available.

Modell 275 Repetier-Luftgewehr - der Schiessbuden-Klassiker

Model 275 Repeating Air Rifle



LG Modell 275 Repetier-Luftgewehr:
Für Haus, Hof und Garten.
Bekannt von vielen Schiessbuden.



System:

- Robuster LG Repetierer.
- 12-Schuss-Magazin für Bleirundkugel Nr. 9, 4,4 mm Ø.
- Druckpunktabzug 275-U10.
- Standvisier seitlich verstellbar, Dachkorn höhenverstellbar.

Schaft:

- Nussbaumfarbiger Bucheschaft.
- Rutschfeste, schwarze Schaftkappe.
- Geeignet für Rechts- und Linksschützen.

Lieferumfang:

12-Schuss-Magazin, Schraubendreher und Bedienungsanleitung.

Model 275 repeating air rifle:
For house and garden.
Renowned at many shooting galleries.

Barreled action:

- Stable air rifle repeater.
- 12-shot magazine for lead pellet No. 9, 4.4 mm Ø.
- Two stage trigger 275-U10.
- Laterally adjustable rear sight and adjustable triangular front sight.

Stock:

- Walnut stained hardwood stock.
- Antiskid black butt plate.
- For right and left hand shooters.

Delivered with:

12-shot magazine, screw driver and manual.

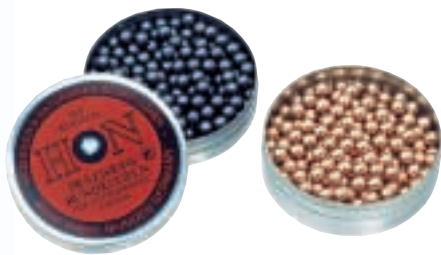

↑
Sicherung.
Safety.





Präzisionslauf
Precision barrel

Korntunnel
Front sight



Magazin 275-U14, 12 Schuss.
Magazine 275-U14, 12-shot.
Best.-Nr.: 700.4612

27 275 Repetierer Luftgewehr (v_0 ca. 110 m/sec).
275 Repeating Rifle (v_0 ca. 110 m/sec).
Best.-Nr.: 578.0000



Modell LP - @ ANSCHÜTZ Pressluft - Zuverlässigkeit pur

Model LP - @ ANSCHÜTZ Compressed Air



Modell LP-@ ANSCHÜTZ Pressluft:

- Mit Schussstabilisator und Mündungskompensator.
- Druckentlastungsbohrungen zur Reduzierung des Mündungsausschlags.
- Leicht von Hand auswechselbare Pressluftkartusche mit Manometer für ca. **150 Schuss**.
- Durch Zusatzgewichte individuell ausbalancierbar.

Abzug:

- Individuelle Einstellung der Abzugsparameter.
- Abzugsgewicht 550 g (ISSF-konform).

Visierung:

- Individuelle Weitenverstellung der Kimmenbreite.
- Dreieckskorn verstellbar auf 4,0, 4,5 und 5,0 mm.
- Präzise Feinkorrektur der Höhen- und Seitenverstellung.

Griff:

- Aus Nussbaumholz.
- In alle Richtungen verstell- und schwenkbar.
- Höhenverstellbare Handballenauflage.

Lieferumfang:

Dreieckskorn, Gewichtsstange, 2 Gewichtsringe, 2 Kartuschen mit Manometer, Nachfülladapter, Sicherheitsring, Spezialfett, Schraubendreher, Bedienungsanleitung mit Original-Schussbild und Pistolenkoffer.



↑
Längen-, höhenverstellbares und schwenkbares Abzugszängel.
Trigger blade to be tilted and adjustable in length and height.

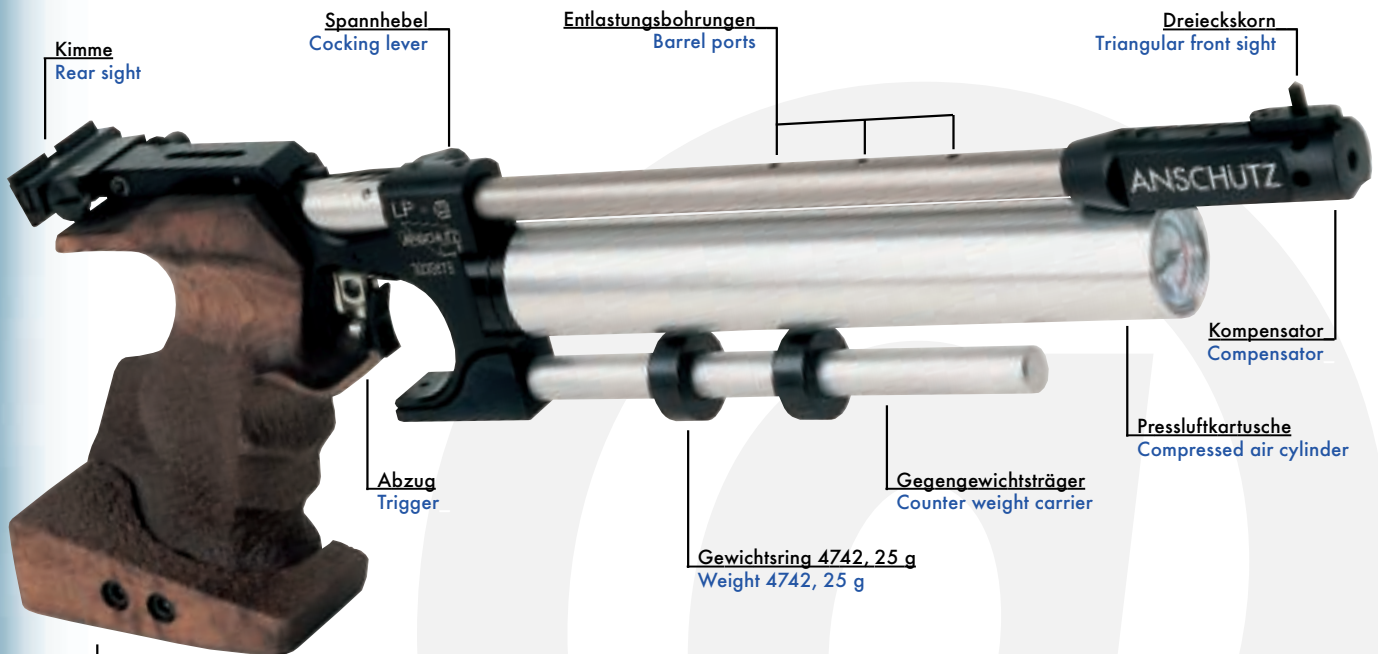

Verstellbare Handballenauflage
Adjustable palm rest

29 LP-@ ANSCHÜTZ Pressluft.
LP-@ ANSCHÜTZ Compressed Air.
Best.-Nr.: 670.0002 Griffgröße M · Grip size M

LP-@ ANSCHÜTZ Pressluft ohne Griff,
ohne Abbildung.
LP-@ ANSCHÜTZ Compressed Air without grip,
without picture.
Best.-Nr.: 670.0009

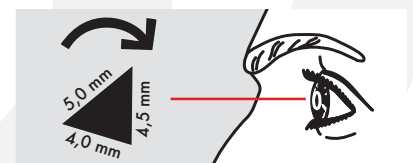

↑
Dreieckskorn für LP-@ ANSCHÜTZ.
Triangular front sight for LP-@ ANSCHÜTZ.
Best.-Nr.: 711.3710

Model LP-@ ANSCHÜTZ Compressed Air:

- With stabilizer and muzzle compensator.
- Pressure reduction holes to reduce movement of muzzle.
- Easy manual exchange of compressed air cylinder with manometer, for approx. **150 shots**.
- Individual balance through additional weights.

Trigger:

- Individual adjustment of trigger parameters.
- Trigger weight 550 g (ISSF conform).

Sight set:

- Individual adjustment of rear sight width.
- Triangular front sight adjustable to 4.0, 4.5 and 5.0 mm.
- Precise vertical and horizontal adjustment.
- Adjustable sighting line.

Grip:

- Of walnut wood.
- Adjustable and tiltable to all directions.
- Palm rest adjustable in height.

Delivered with:

Triangular front sight, weight rod, 2 weights, 2 compressed air cylinders with manometer, filling adapter, safety ring, special grease, screw driver, manual with test target and pistol case.



↑
Sicherheitsring für LP-@ ANSCHÜTZ.
Safety ring for LP-@ ANSCHÜTZ.
Best.-Nr.: 007791

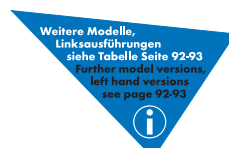

Modell LP-@ ANSCHÜTZ

Pressluft LIGHT:

- Leichter und mit verkürzter Visierlänge.
- Kürzere Pressluftkartusche mit Manometer, für ca. **100 Schuss**.
- Alle Griffgrößen montierbar.

Lieferumfang:

Dreieckskorn, 2 Kartuschen mit Manometer, Nachfülladapter, Sicherheitsring, Spezialfett, Schraubendreher, Bedienungsanleitung mit Original-Schussbild und Pistolenkoffer.

Model LP-@ ANSCHÜTZ

Compressed Air LIGHT:

- Lower weight and shorter sighting line.
- Shorter compressed air cylinder with manometer for approx. **100 shots**.
- All grip sizes available.

Delivered with:

Triangular front sight, 2 compressed air cylinders with manometer, filling adapter, safety ring, special grease, screw driver, manual with test target and pistol case.

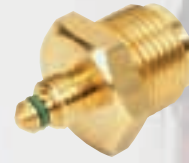

↑
Nachfülladapter für LP-@ ANSCHÜTZ.
Refill adapter for LP-@ ANSCHÜTZ.
Best.-Nr.: 711.3511



32 LP-@ ANSCHÜTZ Pressluft LIGHT.
LP-@ ANSCHÜTZ Compressed Air LIGHT.
Best.-Nr.: 670.0004 Griffgröße XS · Grip size XS



← **Pistolengriff für LP-@ ANSCHÜTZ:**
Pistol grip for LP-@ ANSCHÜTZ:
XS: **Best.-Nr.: 705.8004**
S: **Best.-Nr.: 705.8001**
M: **Best.-Nr.: 705.8002**
L: **Best.-Nr.: 705.8003**
M: **Best.-Nr.: 705.8102** links · left



↑
Gewichtsring 4742, 25 g, Innen-Ø 12 mm.
Weight 4742, 25 g, inner Ø 12 mm.
Best.-Nr.: 711.3805



↑
Gegengewichtsträger, 100 g, ohne Gewichtsringe, mit Aufnahme.
Counter weight carrier, 100 g, without weights, with carrier.
Best.-Nr.: 711.3800



↑
Pistolenkoffer für LP-@ ANSCHÜTZ.
Pistol case for LP-@ ANSCHÜTZ.
Best.-Nr.: 711.3598

Das Individual-Programm

The Individual Offer

Unsere Wechselsysteme bieten mehrere Kombinationsmöglichkeiten mit Wechselschäften. Linksausführungen sind mit **L** gekennzeichnet.

Our barreled actions can be combined with various stocks. The models marked with **L** are available in left hand version.



8002 Pressluft, silberne Kartusche · Compressed Air, silver air-cylinder



8002 JUNIOR/LIGHT Pressluft · JUNIOR/LIGHT Compressed Air



8002 Pressluft, blaue Kartusche · Compressed Air, blue air-cylinder



8002 Pressluft, rote Kartusche · Compressed Air, red air-cylinder

Best.-Nr. Item No.	Modell Model	Hinweis Note	Kaliber Caliber	Geschossführung/Lauflänge Rifling/Barrel length	Gewicht ca. Weight approx.
560.2978	8002	Pressluft, blaue Kartusche · Compressed Air, blue air-cylinder	4,5 mm	42 cm / 64 cm · 16.5" / 25.1"	2,8 kg / 6.1 lbs
560.2979	8002	Pressluft, rote Kartusche · Compressed Air, red air-cylinder	4,5 mm	42 cm / 64 cm · 16.5" / 25.1"	2,8 kg / 6.1 lbs
560.2980	8002	Pressluft, silberne Kartusche · Compressed Air, silver air-cylinder	4,5 mm	42 cm / 64 cm · 16.5" / 25.1"	2,8 kg / 6.1 lbs
560.2985	8002 JUNIOR/LIGHT	Pressluft, silberne Kartusche · Compressed Air, silver air-cylinder	4,5 mm	42 cm / 59 cm · 16.5" / 23.2"	2,3 kg / 5.0 lbs
560.2981	8002L	Pressluft, silberne Kartusche · Compressed Air, silver air-cylinder L	4,5 mm	42 cm / 64 cm · 16.5" / 25.1"	2,8 kg / 6.1 lbs



Best.-Nr. Item No.	Modell Model	Hinweis Note
705.6004	8002	Bunt JUNIOR, rechts/links Color JUNIOR, right/left
705.6005	8002	Nuss natur VEREIN, rechts/links Walnut non-stained, CLUB, right/left
705.6006	8002	Bunt mit ALU-Schafftkappe 4759 Color with ALU butt plate 4759
705.6016	8002	Nuss natur AUFLAGE, rechts/links Walnut non-stained, BENCHREST, right/left



Best.-Nr. Item No.	Modell Model	Hinweis Note	Alu-Bunt Alu color
705.6014	8002	Silber/schwarz, Griffgröße L Silver/black, grip size L	
705.6015	8002	Silber/schwarz, Griffgröße M Silver/black, grip size M	
705.6009	8002	Schwarz/schwarz, Griffgröße L Black/black, grip size L	
705.6010	8002	Schwarz/schwarz, Griffgröße M Black/black, grip size M	
705.6011	8002A	AUFLAGE, schwarz/schwarz, Griffgröße L BENCHREST, black/black, grip size L	
705.6012	8002A	AUFLAGE, schwarz/schwarz, Griffgröße M BENCHREST, black/black, grip size M	
705.6013	8002L	Schwarz/schwarz, Griffgröße L Black/black, grip size L L	



9003 Pressluft, silberne Kartusche · Compressed Air, silver air-cylinder

9003

Best.-Nr. Item No.	Modell Model	Hinweis Note	Kaliber Caliber	Geschossführung/Lauflänge Rifling/Barrel length	Gewicht ca. Weight approx.
560.4980	9003	Pressluft, silberne Kartusche · Compressed Air, silver air-cylinder	4,5 mm	42 cm / 64 cm · 16.5" / 25.1"	2,8 kg / 6.1 lbs



Best.-Nr. Item No.	Modell Model	Hinweis Note
705.6000	9003	Schwarz/schwarz, Griffgröße M Black/black, grip size M
705.6001	9003	Schwarz/schwarz, Griffgröße L Black/black, grip size L
705.6002	9003A	AUFLAGE, schwarz/schwarz, Griffgröße M BENCHREST, black/black, grip size M
705.6003	9003A	AUFLAGE, schwarz/schwarz, Griffgröße L BENCHREST, black/black, grip size L

KK-Matchgewehre
Small Bore Target Rifles



Modell 1903 KK-Matchgewehr - für den Einsteiger

Model 1903 Small Bore Target Rifle



KK-Modell 1903 - Matchgewehr:

- Klassisches KK-Einsteigergewehr.
- Robust, langlebig, präzise, daher als Vereinsgewehr geeignet.
- Als Rechts- und Linksgewehr lieferbar.

Schaft:

- Anatomisch perfekter Nussbaumschaft.
- Individuell verstellbare Schaftbacke durch Zwischenplatten.
- Schaftkappe 4709 A verstellbar in Höhe und Länge.
- Möglichkeit zur Anbringung der Gummikappe 4709 B sowie Alu-Kappen 4759 und 4758.

Lieferumfang:

Handstopp 6226, Schraubendreher, Innensechskantschlüssel, Bedienungsanleitung und Original-Schussbild.

Visierung siehe Zubehör.

Weitere Modellvarianten siehe Individualprogramm. Die dort angebotenen Wechselschäfte und Wechselsysteme können kombiniert werden.



↑
Alu-Profileschiene für Handstopp.
Aluminum grooved rail for hand stop.
Best.-Nr.: 003297



33 1903 Nuss natur.
Abbildung mit Visierung 6834.
1903 Walnut non-stained.
Picture with sight set 6834.
Best.-Nr.: 210.0900



35 1903 JUNIOR Target.
1903 JUNIOR Target.
Best.-Nr.: 210.4000

KK-Modell 1903 Junior Target:

- Speziell auf die Bedürfnisse von Jugendlichen abgestimmt.
- Leichter und kürzerer Matchlauf.
- Kleiner, leichter und einstellbarer Buchenschaft für Rechts- und Linksschützen.
- Alu-Profileschiene am Vorderschaft für Handstopp.
- Mit Druckpunkt-Abzug 5098.
- Prismenschiene für Diopter-Visierung 6834 oder 7020.

Lieferumfang:

Schraubendreher, Innensechskantschlüssel, Bedienungsanleitung und Original-Schussbild.
Visierung siehe Zubehör.

Small bore model 1903 Junior Target:

- Especially adapted to the requirements of juniors.
- Lighter and shorter target barrel.
- Small, light and adjustable hardwood stock for right and left hand shooters.
- Aluminum rail at fore-end for hand stop.
- With two stage trigger 5098.
- Rail for sight sets 6834 or 7020.

Delivered with:

Screw driver, Allan key, manual with test target.
Sight sets see Accessories.



↑
Alu-Profileschiene für Handstopp.
Aluminum grooved rail for hand stop.
Best.-Nr.: 003063

Small bore model 1903 – match rifle:

- Classic small bore starter model.
- Stable, long service-life, accurate, therefore suitable as club rifle.
- Available as right and left hand rifle.

Stock:

- Anatomically perfect walnut stock.
- Individually adjustable cheek piece through spacers.
- Butt plate 4709 adjustable in height and length.
- Possibility to attach rubber butt plate 4709 B as well as aluminum butt plates 4759 and 4758.

Delivered with:

Hand stop 6226, screw driver, Allan key, manual with test target.

Sight sets see Accessories.

Further model versions can be selected from the components of our individual offer. The listed stocks and barreled actions can be combined.



① **Gummikappe 4709B-U1**, gewölbt.
Rubber butt plate 4709B-U1, convex.
Best.-Nr.: 710.3710

② **Gummikappe 4709A-U1**, gerade.
Rubber butt plate 4709 A-U1, straight.
Best.-Nr.: 710.3700

③ **Führungsplatte 4709A-U2/1**,
komplett für Gummikappe
Guide plate 4709A-U2/1,
complete for rubber butt plate.
Best.-Nr.: 710.3715

④ **Zwischenplatte 4709P**, parallel 8 mm.
Spacer 4709P, parallel 8 mm.
Best.-Nr.: 710.3750

Präzisions-Matchlauf
Precision match barrel

Korntunnel
Front sight



Modell 64 R Sporter Target

Model 64 R Sporter Target

KK-Jagdmatch Repetierer

64 R Sporter Target:

- Match 64 System im Kaliber .22 l.r.
- Mit Match-Druckpunktabzug.
- Bucheschaft mit Alu-Profileschiene.
- Für Wald und Wiese aber auch fürs Sportschiessen.
- Verwendung als Einzellader möglich durch Adapter 4846.

Small bore hunting match repeater
64 R Sporter Target:

- Match 64 barreled action in cal. .22 l.r.
- With match two stage trigger.
- Hardwood stock with aluminum rail.
- For the field and for target shooting.
- To be used as single loader through adapter 4846.

Delivered with:

Single loader adapter 4846, screw driver, Allan key, manual with test target.

Sight sets see Accessories.

36 64 R Sporter Target.
64 R Sporter Target.
Best.-Nr.: 219.4500

Lieferumfang:

Einzelladeradapter 4846, Schraubendreher, Innensechskantschlüssel, Bedienungsanleitung und Original-Schussbild.

Visierung siehe Zubehör.

Mögliches Zubehör/Erweiterungen:
Possible accessories/extensions:

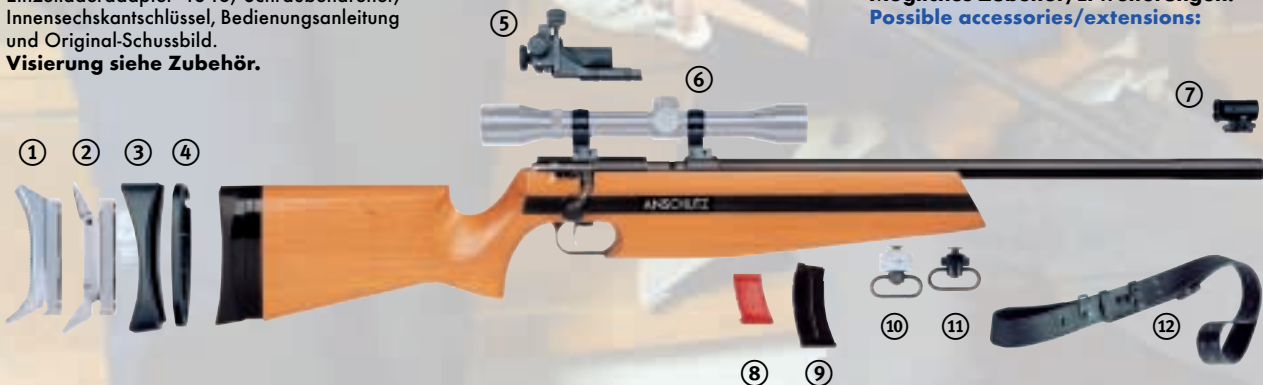

① **Alu-Schaftkappe 4758.**
Aluminum butt plate 4758.
Best.-Nr.: 700.3592

⑤ **Präzisionsdioptr 6805.**
Rear sight 6805
Best.-Nr.: 700.0115

⑨ **5 Schuss Magazin 1420-U 5.**
5-shot magazine 1420-U 5.
Best.-Nr.: 700.4005

② **Alu-Schaftkappe 4759.**
Aluminum butt plate 4759.
Best.-Nr.: 700.3590

⑥ **Aufschubmontage 5516/26-1.**
Mount ring 5516/26-1.
Best.-Nr.: 710.1600

⑩ **Handstopp 6226**, mit Riemenbügel.
Hand stop 6226, with sling swivel.
Best.-Nr.: 710.3600

③ **Gummikappe 4709 B-U1**, gewölbt.
Rubber butt plate 4709 B-U1, convex.
Best.-Nr.: 710.3710

⑦ **Korntunnel 6832**, schwenkbar.
Front sight 6832, tilting.
Best.-Nr.: 700.0221

⑪ **Handstopp 6225**, mit Riemenbügel.
Hand stop 6225, with sling swivel.
Best.-Nr.: 710.3610

④ **Zwischenplatte 4709 P.**
Spacer 4709 P.
Best.-Nr.: 710.3750

⑧ **Einzelladeradapter 4846.**
Single loader adapter 4846.
Best.-Nr.: 710.4700

⑫ **Schiessriemen 7400 S**, Synthetik, schwarz.
Target sling, synthetic, black
Best.-Nr.: 710.3017

Das Individual-Programm

The Individual Offer

Unsere Wechselsysteme bieten mehrere Kombinationsmöglichkeiten mit Wechselschäften. Linksausführungen sind mit **L** gekennzeichnet.

Our barreled actions can be combined with various stocks. The models marked with **L** are available in left hand version.

1903 KK-Match



1903-U2



1903 JUNIOR



L 1903L-U2

Best.-Nr. Item No.	Modell Model	Hinweis Note	Kaliber Caliber	Geschossführung/Lauflänge Rifling/Barrel length	Gewicht ca. Weight approx.
210.0960	1903 - U2	Druckpunktabzug · two stage trigger	.22 l.r.	66 cm / 66 cm · 25.9" / 25.9"	2,5 kg / 5.5 lbs
210.0961	1903 JUNIOR	Druckpunktabzug · two stage trigger	.22 l.r.	54 cm / 54 cm · 21.3" / 21.3"	2,2 kg / 4.9 lbs
210.1960	1903L - U2	Druckpunktabzug · two stage trigger	L .22 l.r.	66 cm / 66 cm · 25.9" / 25.9"	2,5 kg / 5.5 lbs



Best.-Nr. Item No.	Modell Model	Hinweis Note
705.0101	1903-U4	Nuss natur / Walnut non-stained
705.0111	1903L-U4	Nuss natur / Walnut non-stained L



Best.-Nr. Item No.	Modell Model	Hinweis Note
705.0102	1903 JUNIOR	Buche / Hardwood



64 R Sporter Target

64 R

Best.-Nr. Item No.	Modell Model	Hinweis Note	Kaliber Caliber	Geschossführung/Lauflänge Rifling/Barrel length	Gewicht ca. Weight approx.
219.4010	64 R Sporter Target	Druckpunktabzug · two stage trigger	.22 l.r.	54 cm / 54 cm · 21.3" / 21.3"	2,2 kg / 4.9 lbs



Best.-Nr. Item No.	Modell Model	Hinweis Note
705.0291	64 R Sporter Target	Buche / Hardwood



KK-Match Sportgewehre
Small Bore Target Sport Rifles

Modell 1907 KK-Matchgewehr - bewährte Qualität

Model 1907 Small Bore Target Rifle



KK-Modell 1907 – Matchgewehr:

- Weiterentwicklung des erfolgreichen Systems Match 54.
- Weltweit bevorzugtes Modell der KK-Schützen.
- Individuell feinst einstellbarer Matchabzug 5018.
- Kürzeste Schussentwicklungszeit.
- Extrem leicht gängiges Schloss.
- Leichter Matchlauf 660 mm lang.

Lieferumfang:

Handstopp 4751, Schraubendreher, Innensechskantschlüssel, Bedienungsanleitung und Original-Schussbild.

Weitere Modellvarianten siehe Individualprogramm. Die dort angebotenen Wechselschäfte und Wechselsysteme können kombiniert werden.



↑
Exzentrisch gelagertes Schloss in der Verschlusshülse.
Eccentric bolt in the receiver.

Schaft:

- Geschränkter Nussbaumschaft.
- Vielseitig und stufenlos verstellbare Alu-Kappen- und Backenverstellung.
- Anbringung der Hakenkappe 2213-8700 auf Ausleger möglich.



Sicherung
Safety

Match 54 Verschluss
Match 54 action

Griffige Punzierung
Stippled checkering

Schaftbacke
Cheek piece

Diopter
Rear sight

Alu-Säulen
Aluminum columns

Alu-Schaftkappe
Aluminum butt plate

Abzug 5018
Trigger 5018

Schaft für Rechts- und Linksschützen
Stock for right and left hand shooters

Vorbereitet für Alu-Kappenausleger
Prepared for the aluminum carrier

Führungsplatte
Guide plate

Gummikappe, verstellbar
Rubber butt plate, adjustable



Mögliche Erweiterung.
Possible extension.

Small bore model 1907 – target rifle:

- Improvement of the famous barreled action Match 54.
- Favorite rifle of small bore shooters worldwide.
- Individually adjustable match trigger 5018.
- Extremely short locktime.
- Extremely smooth bolt operation.
- Light target barrel 660 mm long.

Stock:

- Crossed walnut stock.
- Multiply and variably adjustable aluminum cheek piece and butt plate adjustment.
- Possibility to attach hook butt plate 2213-8700 to carrier.

Delivered with:

Hand stop 4751, screw driver, Allan key, manual with test target.

Sight sets see Accessories.

Further model versions can be selected from the components of our individual offer. The listed stocks and barreled actions can be combined.

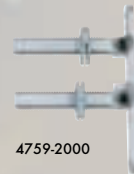

4759-2000



2213-8700
mit - with
2213-8510

Korntunnel
Front sight

Präzisions-Matchlauf
Precision match barrel

37 1907 Nuss mit Alu-Schaftkappe 4759.
Abbildung mit Visierung 7020.
1907 Walnut with Alu butt plate 4759.
Picture with sight set 7020.
Best.-Nr.: 201.0924

Handstopp
Hand stop

Nussbaumschaft
Walnut stock

Profilschiene
Grooved rail

38 1907 VEREIN mit Gummikappe 4709 A.
Lieferung inkl. Visierung 6829.
1907 CLUB with rubber butt plate 4709 A.
delivered incl. sight set 6829.
Best.-Nr.: 201.0926



↑
Einfache, schnelle Verstellmöglichkeiten.
Easy and fast adjustments.

KK-Modell 1907 VEREIN:

- System technisch baugleich mit Modell 1907, jedoch mit anderem Schaft.

Schaft:

- Nussbaumschaft für Rechts- und Linksschützen.
- Individuelle Längenverstellung durch Zwischenplatten 4709P möglich.
- Hinterschaft für Klemmelement und Alu-Kappenausleger 4759-2000 vorbereitet, dadurch längenverstellbar und Anbringung verschiedener Kappen am Ausleger möglich.

Lieferumfang:

Inkl. Visierung, Schraubendreher, Innensechskantschlüssel, Bedienungsanleitung und Original-Schussbild.

Small bore model 1907 CLUB:

- Barreled action identical to Model 1907, but with different stock.

Stock:

- Walnut stock for right and left hand shooters.
- Individual length adjustments via spacers 4709 P.
- Backend prepared for clamping element and aluminum carrier 4759-2000, therefore adjustable in length and possibility to attach various butt plates to carrier.

Delivered with:

Incl. sight set, screw driver, Allan key, manual and original test target.



39 1907 Nuss, mit Gummikappe 4709 A,
Abbildung mit Visierung 7020.
1907 Walnut, with rubber butt plate 4709 A.
Picture with sight set 7020. **Best.-Nr.: 201.0922**



40 1907 Nuss, links mit Alu-Schaftkappe 4759,
Abbildung mit Visierung 7020 L.
1907 Walnut, left with aluminum butt plate 4759.
Picture with sight set 7020 L. **Best.-Nr.: 201.1924**

Modell 1913 im Schaft 1907 - schweres System im Standardschaft

Model 1913 with stock 1907



KK-Modell 1913 im Schaft 1907:

- Kombination aus dem Super Match System des 1913 mit dem Schaft des 1907.
- Individuell feinst einstellbarer Matchabzug 5018.
- Kürzeste Schussentwicklungszeit.
- Extrem leicht gängiges Schloss.
- Schwerer Matchlauf 690 mm lang.



Schaft:

- Geschränkter Nussbaumschaft.
- Vielseitig und stufenlos verstellbare Alu-Kappen- und Backenverstellung.
- Anbringung der Hakenkappe 2213-8700 auf Ausleger möglich.



Lieferumfang:

Handstopp 4751, Schraubendreher, Innensechskantschlüssel, Bedienungsanleitung und Original-Schussbild.



Visierung siehe Zubehör.



Small bore model 1913 in stock 1907:

- Combination of heavy barreled action Super Match of the 1913 with the stock of the 1907.
- Individually adjustable match trigger 5018.
- Extremely short locktime.
- Extremely smooth bolt operation.
- Heavy target barrel 690 mm long.

Stock:

- Crossed walnut stock.
- Multiply and variably adjustable aluminum cheek piece and butt plate adjustment.
- Possibility to attach hook butt plate 2213-8700 to carrier.

Delivered with:

Hand stop 4751, screw driver, Allan key, manual with test target.

Sight sets see Accessories.

Weitere Modellvarianten siehe Individualprogramm. Die dort angebotenen Wechselschäfte und Wechselsysteme können kombiniert werden.

Further model versions can be selected from the components of our individual offer. The listed stocks and barreled actions can be combined.



↑
Handstopp 4751, mit Riemenbügel.
Hand stop 4751, with sling swivel.
Best.-Nr.: 700.3600



↑
Exzentrisch gelagertes Schloss in der Verschlusschule.
Eccentric bolt in the receiver.

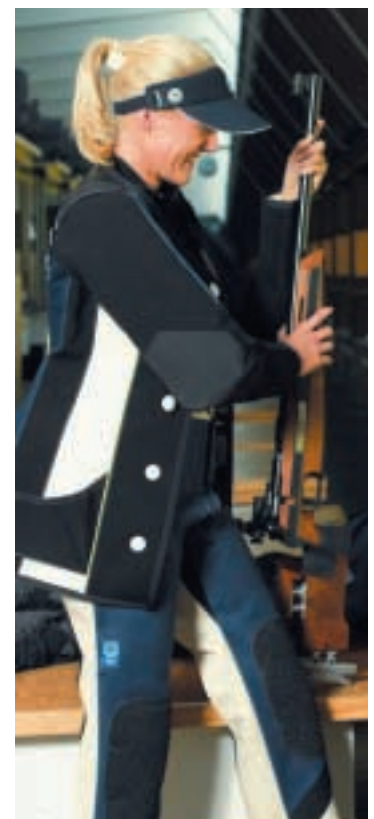



↑
Alu-Profilschiene 1807-23 für Handstopp.
Aluminum grooved rail 1807-23 for hand stop.
Best.-Nr.: 003297



↑
Einfache, schnelle Verstellmöglichkeiten.
Easy and fast adjustments.

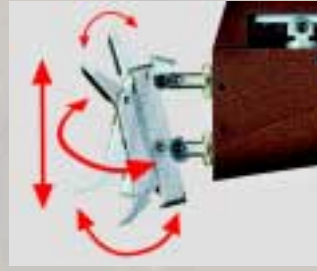

↑
Einfache und schnelle Verstellmöglichkeiten.
Simple and fast adjustment.

Kornstunnel
Front sight

Schwerer Präzisions-Matchlauf
Heavy precision match barrel

Profilschiene
Grooved rail

Handstopp
Hand stop

41 1913 im Schaft 1907 Nuss mit Alu-Schaftkappe 4759.
Abbildung mit Visierung 7020.
1913 with stock 1907 Walnut with Alu butt plate 4759.
Picture with sight set 7020.
Best.-Nr.: 202.0920*



↑
Hakenkappe 4765-U4,
komplett mit Haken 4765-U3.
Hook butt plate 4765-U4,
complete with 4765-U3.
Best.-Nr.: 700.3582

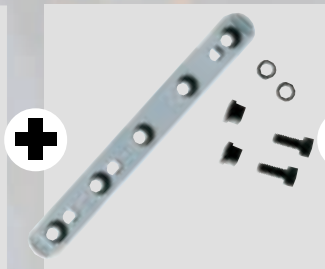

↑
Führungssäule 4759-4000,
4760-20/1 mit Befestigungselementen.
Guide column 4759-4000,
4760-20/1 with fixing elements.
Best.-Nr.: 700.3566



↑
Zwischenplatte 2213-8510-01-00-3
zur Montage der Führungssäule 4759-4000
auf Ausleger 2213-8300.
Spacer 2213-8510-01-00-3
to connect guide column 4759-4000 to
hook plate carrier 2213-8300.
Best.-Nr.: 002011

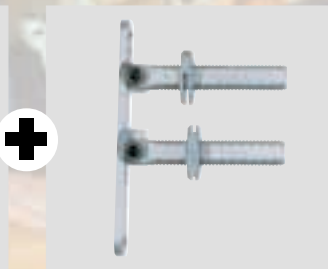

↑
Kappenausleger 4759-2000, 30 mm,
mit schwenkbarer Säulenführung.
Butt plate carrier 4759-2000, 30 mm,
with tilting column guide.
Best.-Nr.: 700.3564

Modell 1912 Sportgewehr - das leichte „Super Match“

Model 1912 Small Bore Target Rifle



KK-Modell 1907 im Schaft 1912:

Für Sportgewehr-Disziplin bis 6,5 kg und den Wettbewerb 3 Stellungen.



System:

- System technisch baugleich mit Modell 1907, jedoch mit anderem Schaft.



Schaft:

- Geschränkter, naturbelassener Nussbaum Lochscharf.
- Vielseitig verstellbare Alu-Kappen- und Backenverstellung.
- Flacher Vorderschaft.
- 2-fach in der Höhe verstellbare und in der Länge verschiebbare Vorderschaftserhöhung.



Lieferumfang:

Handstopp 6226, Vorderschaftserhöhung 4856, Schraubendreher, Innensechskantschlüssel, Bedienungsanleitung und Original-Schussbild.

Visierung siehe Zubehör.

Weitere Modellvarianten siehe Individualprogramm. Die dort angebotenen Wechselschäfte und Wechselsysteme können kombiniert werden.

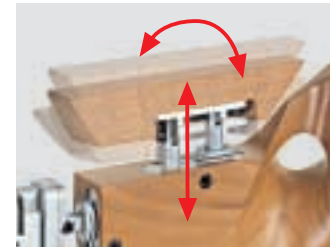

↑
Stufenlose Backenverstellmöglichkeit.
Simple adjustments of cheek piece.



Small bore model 1907 in stock 1912:

For sport rifle discipline up to 6.5 kg and for 3 position shooting.

Barreled action:

- Barreled action identical to model 1907 but with different stock.

Stock:

- Crossed, non-stained walnut thumbhole stock.
- Multiple adjustable aluminum butt plate and cheek piece adjustment.
- Flat fore-end.
- Double height adjustment and length adjustment of fore-end stock.

Delivered with:

Hand stop 6226, fore-end raiser block 4856, screw driver, Allan key, manual with test target.

Sight sets see Accessories.

Further model versions can be selected from the components of our individual offer. The listed stocks and barreled actions can be combined.



↑
Hakenkappe 2213-8700 auf Ausleger 2213-8300 montiert.
Hook butt plate 2213-8700 with carrier 2213-8300.



↑
Vorderschafterhöhung 4856, 32 mm hoch.
Fore-end raiser block 4856, 32 mm high.
Best.-Nr.: 700.3622



↑
Universal Mikrometerdiopfer 7002/20 (20er Klick / Umdrehung).
Universal micrometer rear sight 7002/20 (20 clicks / at one turn).
Best.-Nr.: 700.0171

Präzisions-Matchlauf
Precision match barrel

Korntunnel
Front sight

Profilschiene
Grooved rail

Handstopp
Hand stop

42 1907 im Schaft 1912 Nuss (1912 Sport Gewehr).
Abbildung mit Visierung 7020.
1907 with stock 1912 Walnut (1912 Target Rifle).
Picture with sight set 7020.
Best.-Nr.: 201.6920



↑
Vorderschafterhöhung 4852/1 schwarz, Höhe 38 mm.
Fore-end raiser block 4852/1 black, 38 mm high.
Best.-Nr.: 700.3621 *



↑
Schaftzusatzgewicht 2013-U80, Gesamtgewicht 495 g, inklusive 4 Gewichtssteine 2013-U82 (à 75 g).
Additional weight 2013-U80, 495 g, with 4 weights 2013-U82 (75 g each).
Best.-Nr.: 711.3000



↑
Exzentriscch gelagertes Schloss in der Verschlusshülse.
Eccentric bolt in the receiver.

Modell 1907 im Schaft 2213 Alu - das KK-Sportgewehr

Model 1907 Small Bore Target Rifle in stock 2213 Alu



KK-Modell 1907 im Schaft 2213 Alu:
System technisch baugleich mit Modell 1907, jedoch mit Aluminium-Schaft.



Schaft:

- Alu-Schaft mit vielseitiger Alu Kappen- und Backenverstellung.
- Extrem flacher Vorderschaft, dadurch tiefere Auflage beim Liegend- und Knieendschiessen möglich.
- Pistolengriff nach vorne und hinten verstellbar sowie schwenkbar und drehbar.



Lieferumfang:

Handstopp 4752, Vorderschafterhöhung, Schraubendreher, Innensechskantschlüssel, Bedienungsanleitung und Original-Schussbild.



Visierung siehe Zubehör.



Small bore model 1907 in stock 2213 Alu:
Barreled action identical to Model 1907 but with aluminum stock.

Stock:

- Aluminum stock with multi-adjustable aluminum butt plate and cheek piece adjustment.
- Extremely flat fore-end therefore lower barrel position for prone and kneeling possible.
- Pistol grip cantable from side to side and adjustable from front to rear.

Delivered with:

Hand stop 4752, fore-end raiser block, screw driver, Allan key, manual and test target.

Sight sets see Accessories.

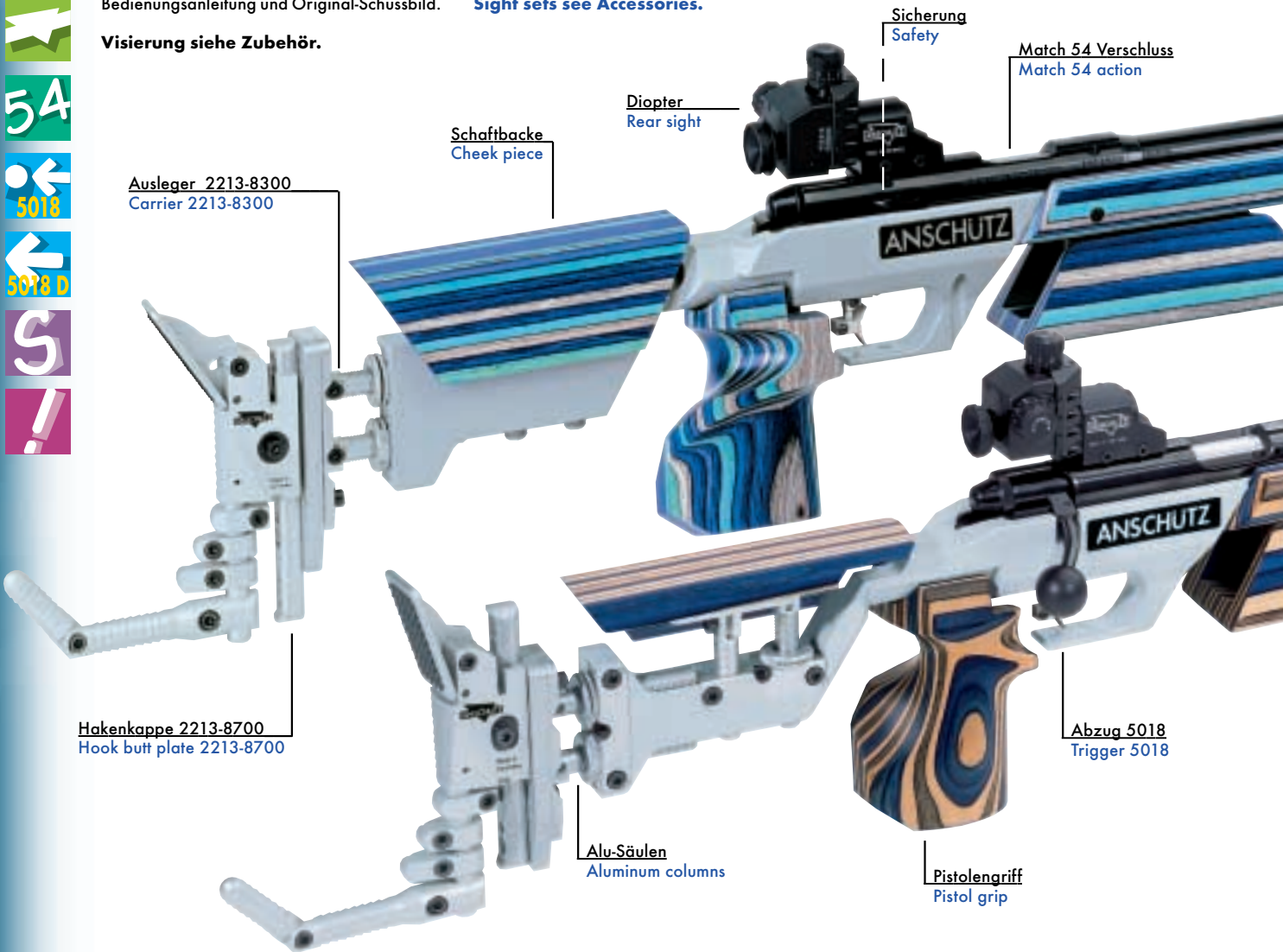
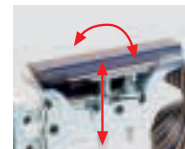

↑
Kappenausleger 2213-8300,
mit schwenkbarer Säulenführung.
Carrier 2213-8300,
with tilting column guide.
Best.-Nr.: 700.3563

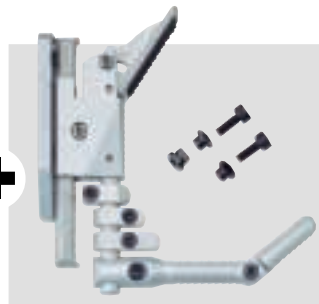

↑
Hakenkappe 2213-8700,
kompl. mit Führungsplatte 2213-8510.
Hook butt plate 2213-8700,
complete with guide plate 2213-8510.
Best.-Nr.: 700.3569



↑
Alu Führungsplatte 2213-8510,
komplett.
Alu guide plate 2213-8510,
complete.
Best.-Nr.: 700.3568

Silber/schwarz (Buche)
Silver/black (Hardwood)



Mögliche Farbvariante für Rechtsausführung.
Possible color combination for right hand version.

Weitere Modellvarianten siehe Individualprogramm. Die dort angebotenen Wechselschäfte und Wechselsysteme können kombiniert werden.

Further model versions can be selected from the components of our individual offer. The listed stocks and barreled actions can be combined.

44 1907 links im Schaft 2313 links Alu, blau, mit Adapter 4980.
Abbildung mit Visierung 7020 L.
1907 left with stock 2313 left aluminum, blue, with adapter 4980.
Picture with sight set 7020 L.
Best.-Nr.: 201.6885 Griffgröße M · Grip size M

Korntunnel
Front sight

Profilschiene
Grooved rail

Präzisions-Matchlauf
Precision match barrel

Handstopp
Hand stop

Vorderschafterhöhung
Fore-end raiser block

43 1907 im Schaft 2213 Alu, natur/blau.
Abbildung mit Visierung 7020.
1907 with stock 2313 aluminum, natural/blue.
Picture with sight set 7020.
Best.-Nr.: 201.6875 Griffgröße M · Grip size M



↑
Pistolengriff Bunt, natur/blau
Pistol grip color, natural/blue
Best.-Nr.: 705.7826 Large.
Best.-Nr.: 705.7821 Medium.
Pistolengriff PRO-Grip, schwarz
Pistol grip PRO-Grip, black
Best.-Nr.: 705.7900 Large.
Best.-Nr.: 705.7905 Medium.
Pistolengriff Bunt, blau, links
Pistol grip color, blue, left hand version
Best.-Nr.: 705.7835 Large.
Best.-Nr.: 705.7830 Medium.

NEW Neue Farbe
New color



↑
Adapter 4980 ist nur im Alu-Schaft 2313 links verwendbar.
Adapter 4980 is only available in alu stock 2313 left.
Best.-Nr.: 700.3650



↑
Gewichtsstein 2013-U82, 75 g.
Weight 2013-U82, 75 g.
Best.-Nr.: 711.3011

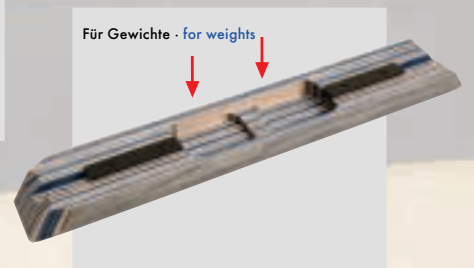

↑
Für Gewichte · for weights
Vorderschafterhöhung 2213-8550, 24 mm hoch, 315 mm lang, natur/blau.
Fore-end raiser block 2213-8550, 24 mm high, 315 mm long, natural/blue.
Best.-Nr.: 700.3634
Best.-Nr.: 700.3624 blau/blue
Best.-Nr.: 700.3625 schwarz/black

Modell 2007/660 im Schaft 2313 Alu - das KK-Sportgewehr

Model 2007/660 Small Bore Target Rifle in stock 2313 Alu



KK-Modell 2007/660 im Schaft 2313 Alu, natur/blau:

System:

- Schwere, rechteckige Verschlusshülse.
- Massivere Ausführung.
- Kompakte System-/Schaftverbindung durch 4 Systembefestigungsschrauben.
- Grosse Bettungsfläche.
- Sehr lange Lauflagerung.
- Lauflänge 660 mm.

Schaft:

- Alu-Schaft mit vielseitiger Alu-Kappen- und Backenverstellung.
- Extrem flacher Vorderschaft, dadurch tiefere Auflage beim Liegend- und Knieend-schiessen möglich.
- Pistolengriff nach vorne und hinten verstellbar sowie schwenkbar und drehbar.
- Mit Vorderschafterhöhung für Stehend-schiessen.

Lieferumfang:

Handstopp 4752, Vorderschafterhöhung, Schraubendreher, Innensechskantschlüssel, Bedienungsanleitung und Original-Schussbild.

Visierung siehe Zubehör.

Weitere Modellvarianten siehe Individualprogramm. Die dort angebotenen Wechselschäfte und Wechselsysteme können kombiniert werden.

NEW Neue Farbe
New color

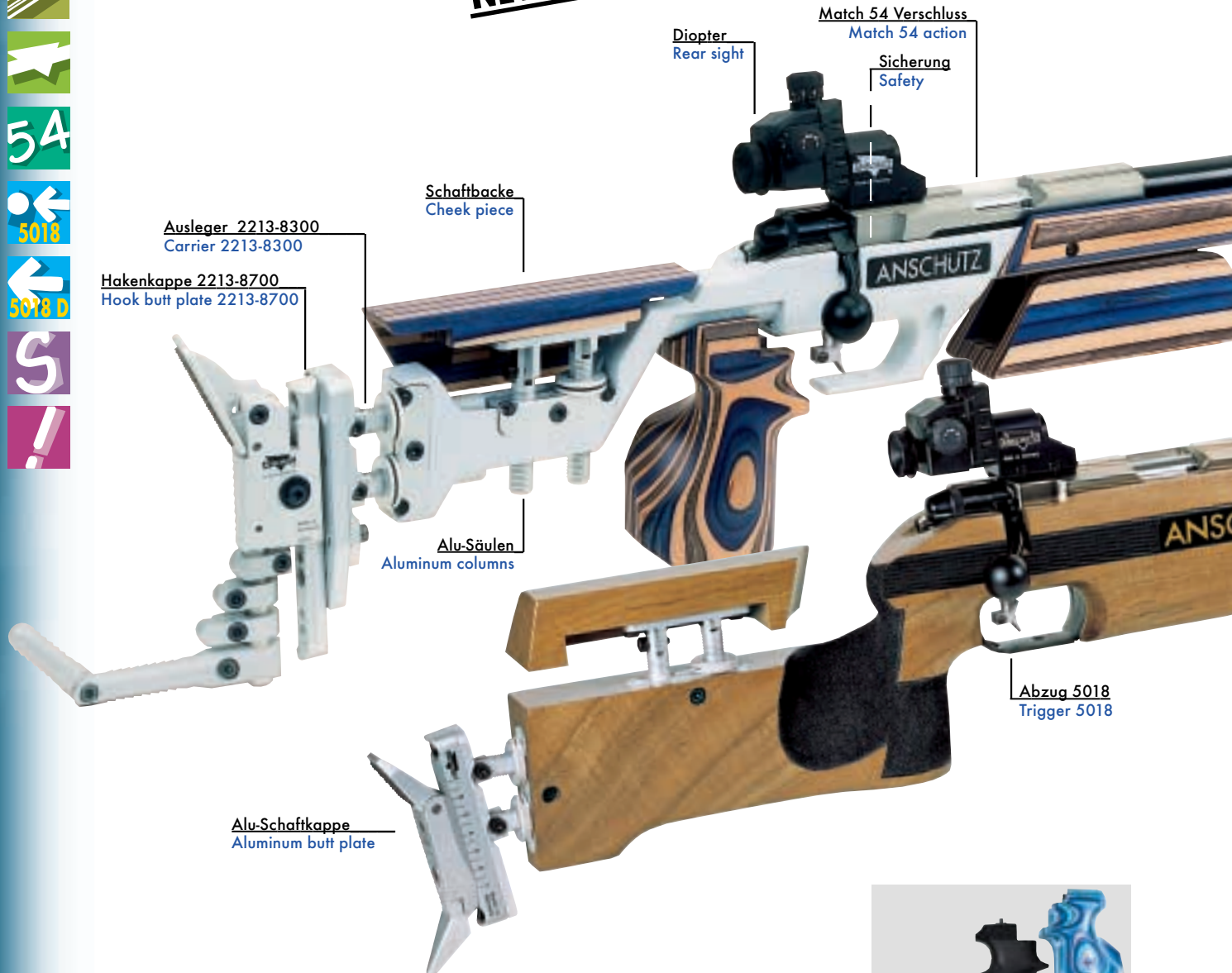

Small bore model 2007/660 in stock 2313 Alu, natural/blue:

Barreled action:

- Heavy rectangular receiver.
- Massive version.
- Compact connection of barreled action and stock by 4 barreled action bedding screws.
- Very long barrel bedding.
- Barrel length 660 mm.

Stock:

- Aluminum stock.
- With multiple adjustable aluminum butt plate and cheek piece adjustment.
- Extremely flat fore-end therefore lower barrel position for prone and kneeling possible.

- Pistol grip cantable from side to side and adjustable from front to rear.
- With fore-end raiser block for standing position.

Delivered with:

Hand stop 4752, fore-end raiser block, screw driver, Allan key, manual and test target.

Sight sets see Accessories.

Further model versions can be selected from the components of our individual offer. The listed stocks and barreled actions can be combined.



Pistolengriff Bunt, natur/blau

Pistol grip color, natural/blue

Best.-Nr.: 705.7826 Large.

Best.-Nr.: 705.7821 Medium.

Pistolengriff PRO-Grip, schwarz

Pistol grip PRO-Grip, black

Best.-Nr.: 705.7900 Large.

Best.-Nr.: 705.7905 Medium.

Pistolengriff Bunt, blau, links

Pistol grip color, blue, left hand version

Best.-Nr.: 705.7835 Large.

Best.-Nr.: 705.7830 Medium.



↑
Kappenausleger 2213-8300,
mit schwenkbarer Säulenführung.
Carrier 2213-8300,
with filling column guide.
Best.-Nr.: 700.3563



↑
Hakenkappe 2213-8700,
kompl. mit Führungsplatte 2213-8510.
Hook butt plate 2213-8700,
complete with guide plate 2213-8510.
Best.-Nr.: 700.3569



Korntunnel
Front sight

45 2007/660 im Schaft 2313 Alu, natur/blau.
Abbildung mit Visierung 7020.
2007/660 with stock 2313 aluminum, natural/blue.
Picture with sight set 7020.
Best.-Nr.: 200.6875 Griffgröße M · Grip size M

Vorderschaftserhöhung
Fore-end raiser block

Präzisions-Matchlauf
Precision match barrel



Profilschiene
Grooved rail

Handstopp
Hand stop

46 2007/660 „Spezial“ Nuss natur mit Alu-Schaftkappe 4759.
Abbildung mit Visierung 7020.
2007/660 "Special" Walnut non-stained with Alu butt plate 4759
Picture with sight set 7020.
Best.-Nr.: 200.0820*

KK-Modell 2007/660 „Special“ Nuss:

Schaft:

- Geschränkter Nussbaumschaft.
- Vielseitig und stufenlos verstellbare Alu-Kappen- und Backenverstellung.
- Anbringung der Hakenkappe 2213-8700 auf Ausleger möglich.

Lieferumfang:

Handstopp 4751, Schraubendreher, Innensechskantschlüssel, Bedienungsanleitung und Original-Schussbild. **Visierung siehe Zubehör.**

Small bore model 2007/660 "Special" Walnut:

Stock:

- Crossed walnut stock.
- Multiple and variably adjustable aluminum cheek piece and butt plate adjustment.
- Possibility to attach hook butt plate 2213-8700 to carrier.

Delivered with:

Hand stop 4751, screw driver, Allan key, manual with test target. **Sight sets see Accessories.**



↑
Gewichtsstein 2013-U82, 75 g.
Weight 2013-U82, 75 g.
Best.-Nr.: 711.3011

*Nur solange Vorrat reicht · As long as available.

Modell 1907 R KK-Matchgewehr - die Mehrlader für CISM

Model 1907 R Small Bore Target Rifle



KK-Modell 1907 R (Mehrlader):

- System technisch baugleich mit Modell 1907, jedoch als Mehrlader.



Schaft Schichtholz:

- Geschänkter Schichtholzschafft.
- Vielseitig und stufenlos verstellbare Alu-Kappen- und Backenverstellung.
- Anbringung der Hakenkappe 2213-8700 auf Ausleger möglich.



Grünig & Elmiger RS III Aluschaft:

- Mit vielseitiger Alu Kappen- und Backenverstellung durch spezielles Zahnstangensystem.
- Aus dem vollen gefräster Aluminiumschafft, dadurch maximale Verwindungsfestigkeit.



- Schwingungsarme Aluminiumlegierung aus der Raumfahrt.
- Pistolengriff nach vorne und hinten verstellbar sowie schwenkbar und drehbar.
- Exzentrisch verlagerbare, versetzbare Profilschiene.

Lieferumfang:

10 Schuss Magazin, Handstopp 4751, Schraubendreher, Innensechskantschlüssel, Bedienungsanleitung und Original-Schussbild.



↑
Exzentrisch gelagertes Schloss in der Verschlusshülse.
Eccentric bolt in the receiver.

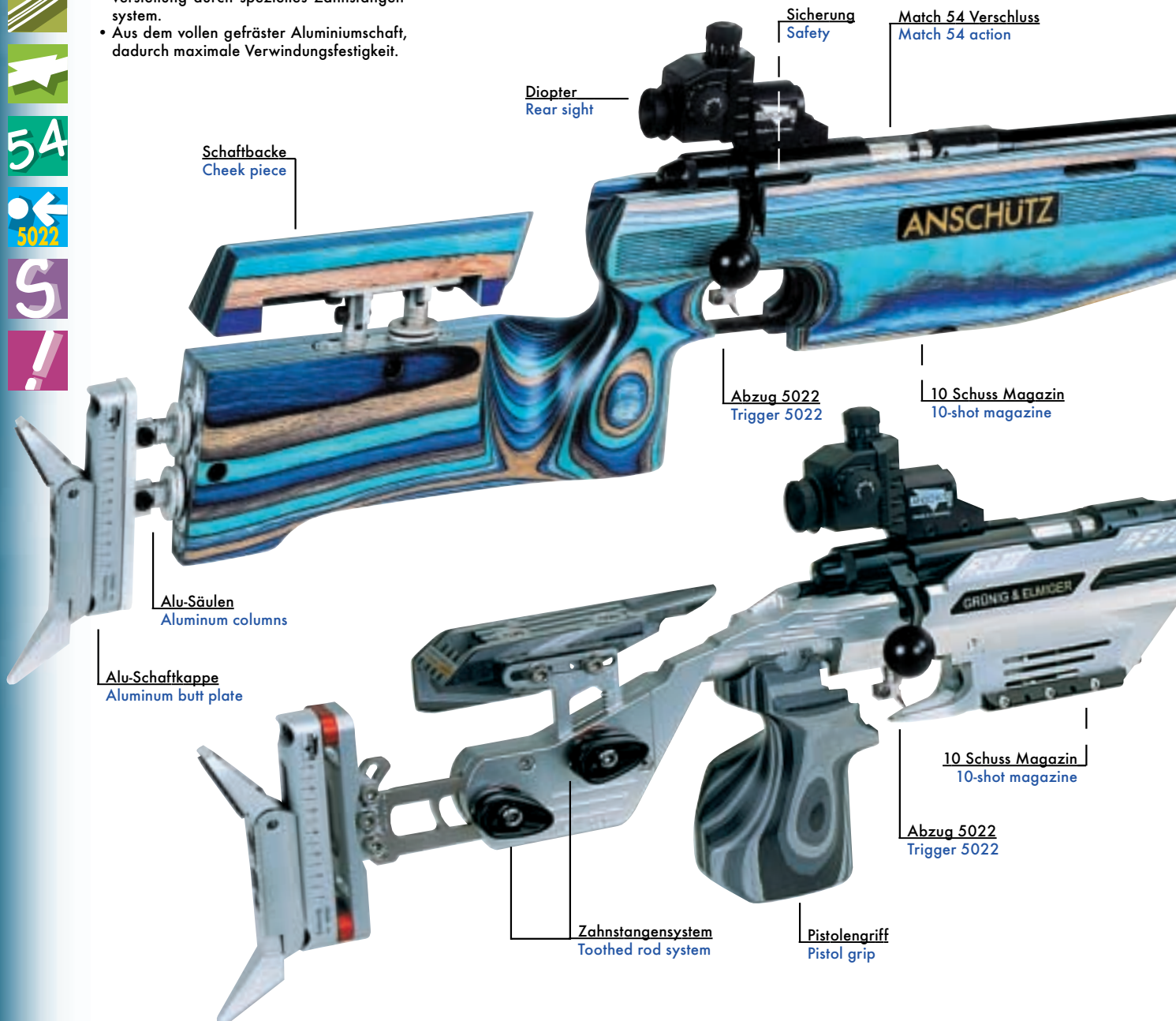

Small bore model 1907 R (Repeater):

- Barreled action identical to Model 1907, but as repeater.

Laminated stock:

- Crossed laminated stock.
- Multiple and variably adjustable aluminum cheek piece and butt plate adjustment.
- Possibility to attach hook butt plate 2213-8700 to carrier.

Grünig & Elmiger RS III aluminum stock:

- With versatile aluminum butt plate and cheek piece adjustment by specially toothed rod system.
- Full material aluminum stock, thus maximum distortion strength.
- Low vibration aluminum alloy from aerospace technology.
- Pistol grip adjustable to front and back, tiltable and turnable.
- Eccentric grooved rail.

Delivered with:

10-shot magazine, hand stop 4751, screw driver, Allan key, manual and original test target.

More Information

www.anschuetz-sport.com



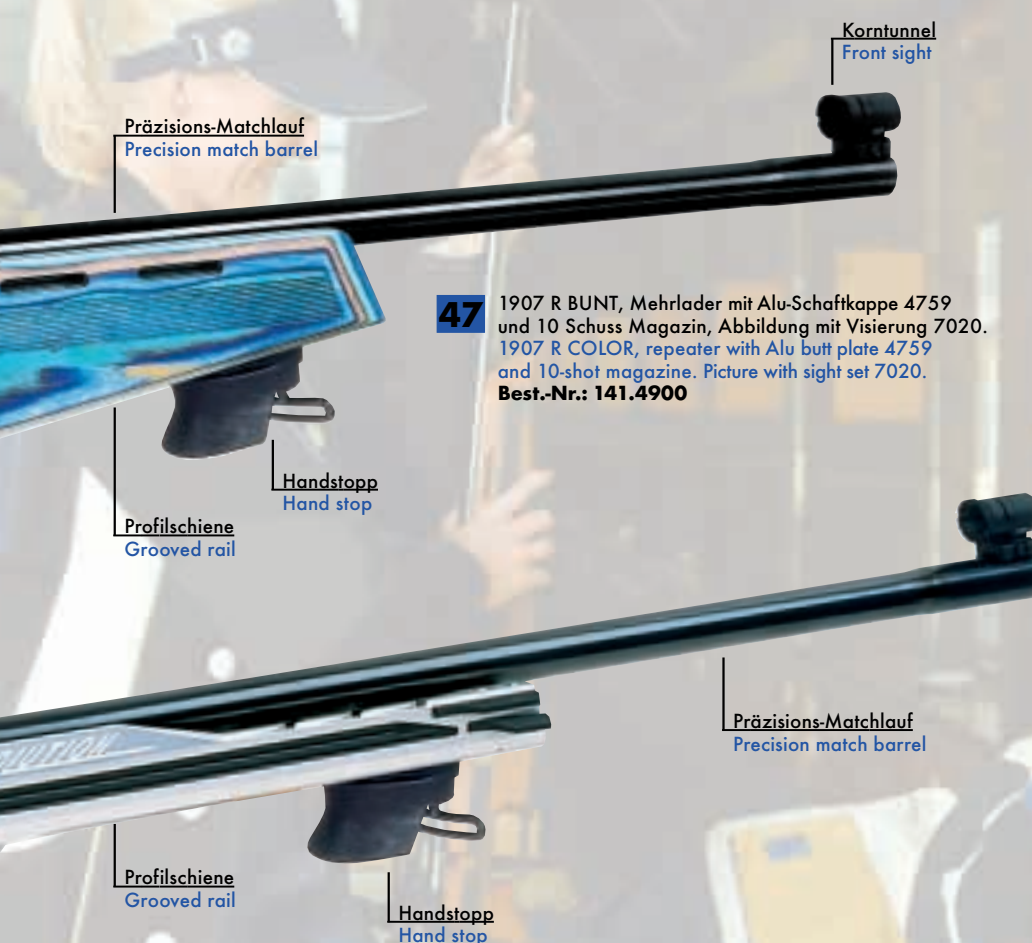

Präzisions-Matchlauf
Precision match barrel

Korntunnel
Front sight

Handstopp
Hand stop

Profilschiene
Grooved rail

47 1907 R BUNT, Mehrlader mit Alu-Schaftkappe 4759 und 10 Schuss Magazin, Abbildung mit Visierung 7020. 1907 R COLOR, repeater with Alu butt plate 4759 and 10-shot magazine. Picture with sight set 7020.
Best.-Nr.: 141.4900

Präzisions-Matchlauf
Precision match barrel

Profilschiene
Grooved rail

Handstopp
Hand stop



↑
Magazin 1420-U13, 10 Schuss, .22 long rifle. Magazine 1420-U13, 10-shot, .22 long rifle. Best.-Nr.: 700.4010



↑
Einzelladeradapter 4846, für Repetierer im Kaliber .22 long rifle. Single shot adapter 4846, for repeaters caliber .22 long rifle. Best.-Nr.: 710.4700

48 1907 R Mehrlader im G&E RS III Revolution Alu-Schaft und 10 Schuss Magazin, Abbildung mit Visierung 7020. 1907 R, repeater with aluminum stock G&E RS III Revolution and 10-shot magazine. Picture with sight set 7020.
Best.-Nr.: 141.4901 Griffgröße M · Grip size M



Das Individual-Programm

The Individual Offer

Unsere Wechselsysteme bieten mehrere Kombinationsmöglichkeiten mit Wechselschäften. Linksausführungen sind mit **L** gekennzeichnet.

Our barreled actions can be combined with various stocks. The models marked with **L** are available in left hand version.

Die 1913 Wechselsysteme sind mit den 1907/1912/2213 Wechselschäften kombinierbar. Die 1907 Wechselsysteme sind mit den 1912/1913/2213 Wechselschäften kombinierbar.

The 1913 barreled actions can be combined with the 1907/1912/2213 stocks. The 1907 barreled actions can be combined with the 1912/1913/2213 stocks.

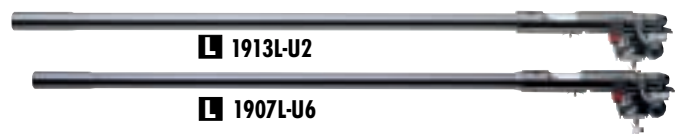

Best.-Nr. Item No.	Modell Model	Hinweis Note	Kaliber Caliber	Geschossführung/Lauflänge Rifling/Barrel length	Gewicht ca. Weight approx.
202.0990	1913 - U2	Druckpunktabzug - two stage trigger	.22 l.r.	69 cm / 69 cm · 27.1" / 27.1"	3,1 kg / 6.8 lbs
202.1990	1913L - U2	Druckpunktabzug - two stage trigger	L .22 l.r.	69 cm / 69 cm · 27.1" / 27.1"	3,1 kg / 6.8 lbs
201.0990	1907 - U6	Druckpunktabzug - two stage trigger	.22 l.r.	66 cm / 66 cm · 25.9" / 25.9"	2,8 kg / 6,1 lbs
201.1990	1907L - U6	Druckpunktabzug - two stage trigger	L .22 l.r.	66 cm / 66 cm · 25.9" / 25.9"	2,8 kg / 6,1 lbs



Best.-Nr. Item No.	Modell Model	Hinweis Note
705.0202	1907	Nuss mit ALU-Schaftkappe 4759 Walnut with ALU butt plate 4759
705.0218	1907L	Nuss mit ALU-Schaftkappe 4759 Walnut with ALU butt plate 4759 L
705.0214	1907 VEREIN 1907 CLUB	Nuss natur mit Gummikappe 4709 A Walnut non-stained with rubber butt plate 4709 A
705.0210	1907	Nuss mit Gummikappe 4709 A Walnut with rubber butt plate 4709 A
705.0330	1912-U4	Nuss natur · Walnut non-stained
705.0350*	1912L-U4	Nuss natur · Walnut non-stained L
705.5865	2213	Natur/blau, Griffgröße M Natural/blue, grip size M
705.5870	2213	Natur/blau, Griffgröße L Natural/blue, grip size L
705.5878	2213 AUFLAGE BENCHREST	Natur/blau, Griffgröße L Natural/blue, grip size L
705.5872*	2213	Silber/schwarz, Griffgröße M Silver/black, grip size M
705.5871*	2213	Silber/schwarz, Griffgröße L Silver/black, grip size L



Best.-Nr. Item No.	Modell Model	Hinweis Note	Kaliber Caliber	Geschossführung/Lauflänge Rifling/Barrel length	Gewicht ca. Weight approx.
200.0990	2013 - U6	Druckpunktabzug - two stage trigger	.22 l.r.	50 cm / 69 cm · 19.6" / 27.1"	3,1 kg / 6.8 lbs
200.0860	2007/660 - U6	Druckpunktabzug - two stage trigger	.22 l.r.	66 cm / 66 cm · 25.9" / 25.9"	3,2 kg / 7.0 lbs



Der Wechselschaft 2313L kann mit dem Adapter 4980 auch mit den Wechselsystemen 1913L-U2 und 1907L-U6 kombiniert werden.
The stock 2313L and the barreled actions 1913L-U2 / 1907L-U6, can be combined with adapter 4980.

Best.-Nr. Item No.	Modell Model	Hinweis Note	Alu-Bunt Alu color
705.5880	2313	Natur/blau, Griffgröße M Natural/blue, grip size M	
705.5875	2313	Natur/blau, Griffgröße L Natural/blue, grip size L	
705.5877*	2313	Silber/schwarz, Griffgröße M Silver/black, grip size M	
705.5876*	2313	Silber/schwarz, Griffgröße L Silver/black, grip size L	
705.5890	2313L	Silber/blau, Griffgröße M Silver/blue, grip size M	L
705.5885	2313L	Silber/blau, Griffgröße L Silver/blue, grip size L	L
705.0403*	2007 - U60	Nuss natur mit ALU-Schaftkappe 4759 Walnut non-stained with ALU butt plate 4759	



KK-Super Match Freie Gewehre
Small Bore Target Free Rifles

Modell 1913 „Super Match“ – internationales Spitzenmodell

Model 1913 "Super Match"



KK-Modell 1913 "Super Match":

- Marktführer bei internationalen Wettbewerben.
- Spezialgewehr für Disziplin 3x40 und Liegend.
- System technisch baugleich mit Modell 1907, jedoch mit anderem Schaft und schwerem Matchlauf 690 mm lang.

Schaft:

- Schwerer, naturbelassener Nussbaum-Lochschaft.
- Universelle, stufenlos verstellbare Kappen- und Backenverstellung.
- Mit Vorderschafterhöhung für Stehend-schiessen.

Lieferumfang:

Handstopp 4752, Vorderschafterhöhung 4852/1, Schraubendreher, Innensechskantschlüssel, Bedienungsanleitung und Original-Schussbild.

Visierung siehe Zubehör.

Weitere Modellvarianten siehe Individualprogramm. Die dort angebotenen Wechselschäfte und Wechselsysteme können kombiniert werden.

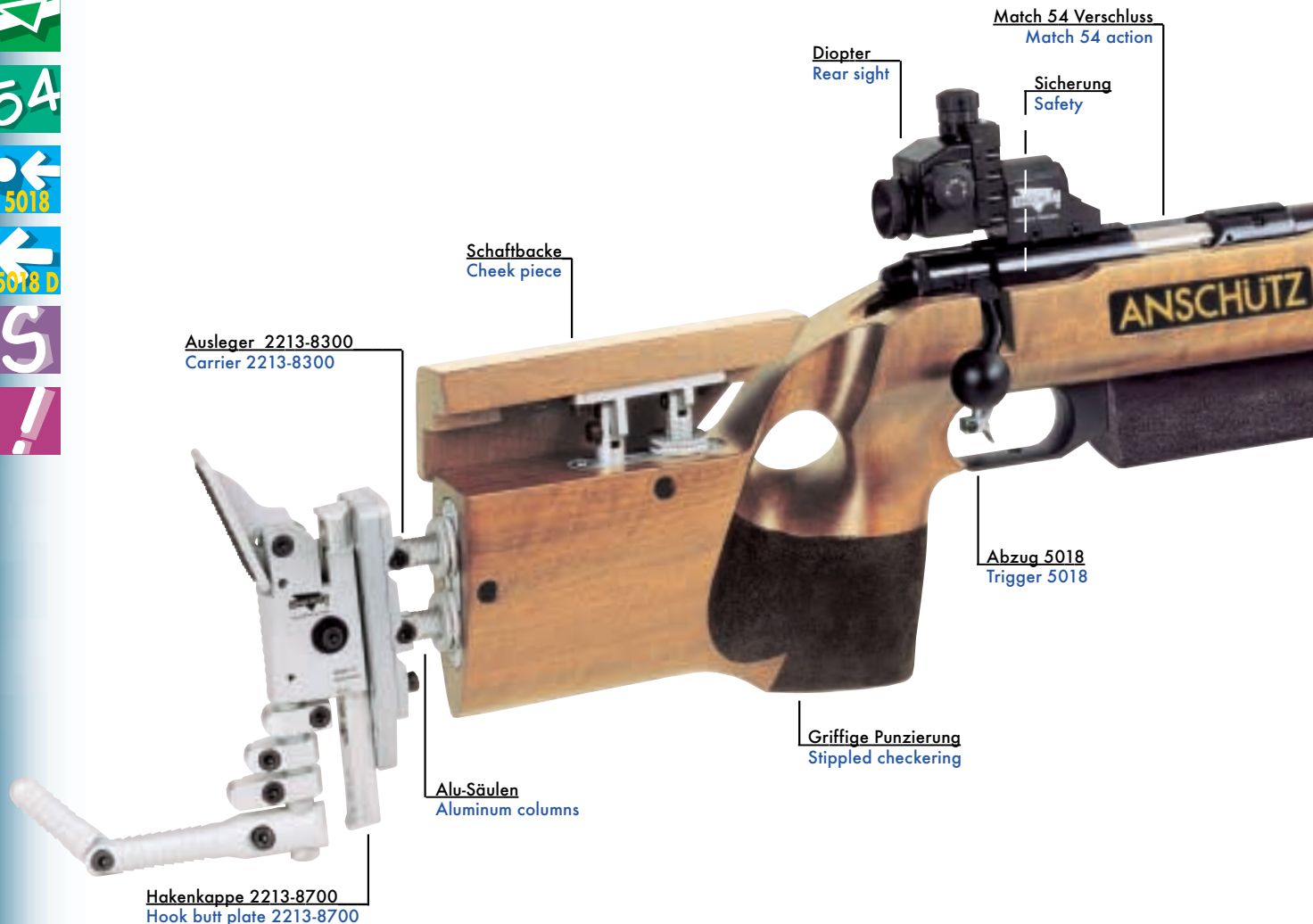

Small bore model 1913 "Super Match":

- Leading rifle at international competitions.
- Special rifle for the discipline 3x40 and prone.
- Barreled action identical to Model 1907 but with different stock and heavy target barrel 690 mm long.

Stock:

- Heavy, non-stained walnut thumbhole stock
- Universal, variable adjustable butt plate and cheek piece adjustment.
- With fore-end raiser block for standing position.

Delivered with:

Hand stop 4752, fore-end raiser block 4852/1, screw driver, Allan key, manual with test target.

Sight sets see Accessories.

Further model versions can be selected from the components of our individual offer. The listed stocks and barreled actions can be combined.



↑
Griffiger, punzierter Pistolengriff.
Stippled checkering at pistol grip.



↑
Kappenausleger 2213-8300,
mit schwenkbaren Säulenführung.
Carrier 2213-8300,
with tilting column guide.
Best.-Nr.: 700.3563

↑
Hakenkappe 2213-8700,
kompl. mit Führungsplatte 2213-8510.
Hook butt plate 2213-8700,
complete with guide plate 2213-8510.
Best.-Nr.: 700.3569

Korntunnel
Front sight



Schwerer Präzisions-Matchlauf
Heavy precision match barrel

Profilschiene
Grooved rail

Handstopp
Hand stop

Vorderschafterhöhung
Fore-end raiser block

49 1913 „Super Match“, Nuss natur mit Vorderschafterhöhung 4852/1.
Abbildung mit Visierung 7020.
1913 “Super Match” Walnut non-stained with fore-end raiser block 4852/1.
Picture with sight set 7020.
Best.-Nr.: 202.0970



↑
Vorderschafterhöhung 4856, Höhe 32 mm,
mit Profilschiene.
Fore-end raiser block 4856,
32 mm high, with rail.
Best.-Nr.: 700.3622



↑
Schafzuzusatzgewicht 2013-U80,
Gesamtgewicht 495 g, inklusive 4 Gewichtsteine
2013-U82 (à 75 g).
Additional weight 2013-U80,
495 g, with 4 weights 2013-U82 (75 g each).
Best.-Nr.: 711.3000*



↑
Exzentrisch gelagertes Schloss in der Verschlusshülse.
Eccentric bolt in the receiver.

Modell 1913 im Schaft 2213 Alu - das KK „Super Match“

Model 1913 Small Bore Target Rifle in stock 2213 Alu



KK-Modell 1913 im Schaft 2213 Alu:

- Marktführer bei internationalen Wettbewerben.
- Spezialgewehr für Disziplin 3x40 und Liegend.
- System technisch baugleich mit Modell 1907, jedoch mit anderem Schaft und schwerem Matchlauf, 690 mm lang.

Schaft 2213:

- Alu-Schaft.
- Mit vielseitiger Alu-Kappen- und Backenverstellung.
- Extrem flacher Vorderschaft, dadurch tiefere Auflage beim Liegend- und Knieendschiessen möglich.
- Pistolengriff nach vorne und hinten verstellbar sowie schwenk- und drehbar.
- Mit Vorderschafterhöhung für Stehendschiessen.

Schaft 2213 AUFLAGE:

- Baugleich mit Schaft 2213, jedoch mit Vorderschafterhöhung Auflage 1022, vielseitig verstellbarer Alu-Schaftkappe Auflage 4759A und Auflage-Schaftbacke PRO-Grip.

Lieferumfang:

- KK-Modell 1913 im Schaft 2213 Alu:**
Handstopp 4752, Vorderschafterhöhung, Schraubendreher, Innensechskantschlüssel, Bedienungsanleitung und Original-Schussbild.

KK-Modell 1913 im Schaft 2213 AUFLAGE:

- Vorderschafterhöhung Auflage 1022, Visierverlängerung, Schraubendreher, Innensechskantschlüssel, Bedienungsanleitung und Original-Schussbild.

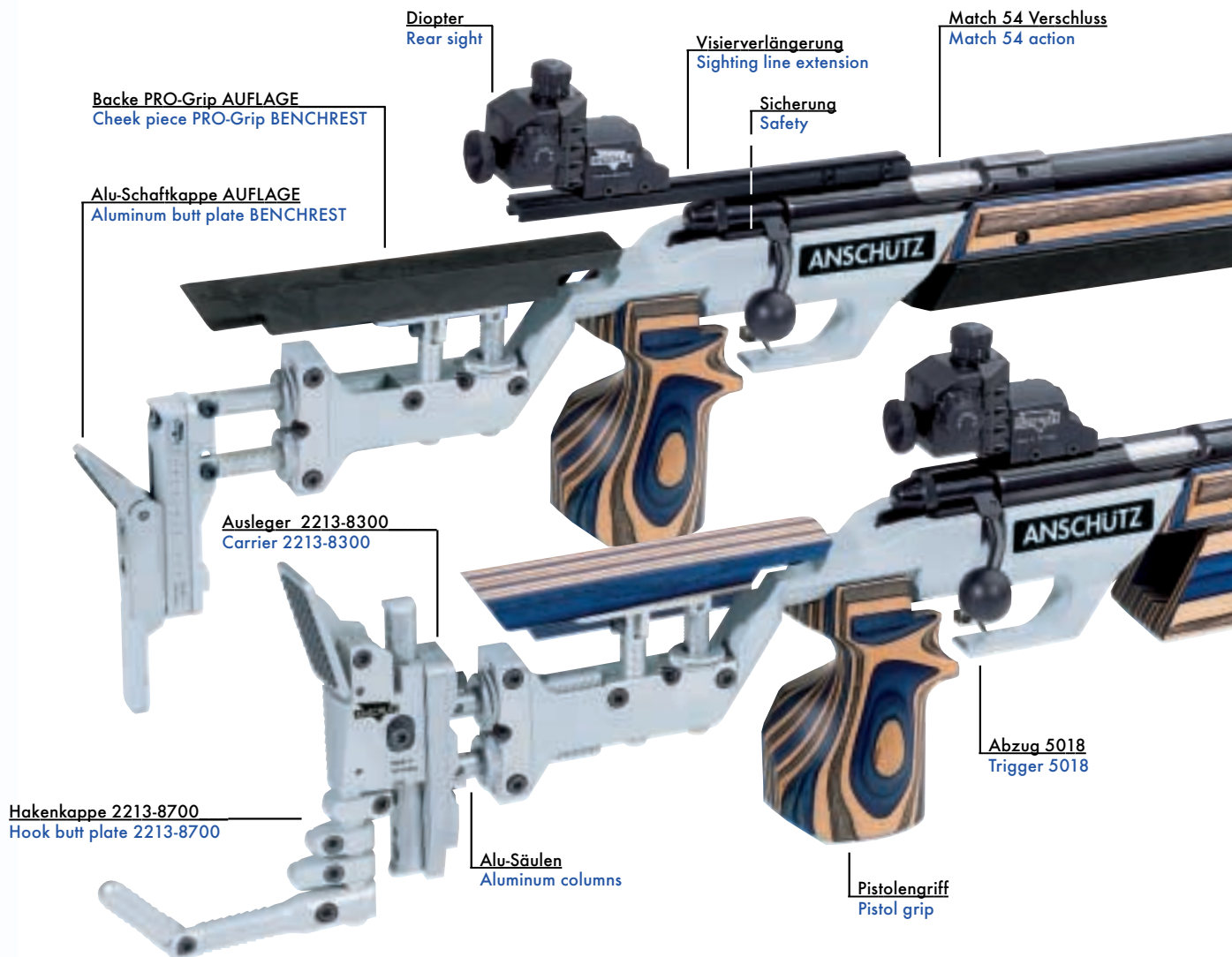
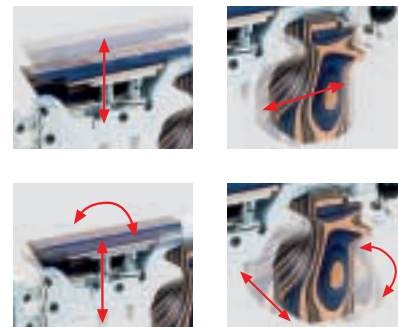

Small bore model 1913 in stock 2213 Alu:

- Leading rifle at international competitions.
- Special rifle for the discipline 3x40 and prone.
- Barreled action identical to Model 1907 but with different stock and heavy target barrel 690 mm long.

Stock 2213:

- Aluminum stock.
- With multiple adjustable aluminum butt plate and cheek piece adjustment.
- Extremely flat fore-end therefore lower barrel position for prone and kneeling possible.
- Pistol grip cantable from side to side and adjustable from front to rear.
- With fore-end raiser block for standing position.

Stock 2213 BENCHREST:

- Identical to stock 2213 but with fore-end raiser block benchrest 1022 and multiple adjustable benchrest aluminum butt plate 4759A and benchrest cheek piece PRO-Grip.

Delivered with:

- Model 1913 in stock 2213 Alu:**
Hand stop 4752, fore-end raiser block, screw driver, Allan key, manual and test target.

Model 1913 in stock 2213 BENCHREST:

- Fore-end raiser block benchrest 1022, sighting line extension, screw driver, Allan key, manual and test target.



↑
Adapter 4980 ist nur im Alu-Schaft 2313 links verwendbar.
Adapter 4980 is only available in aluminum stock 2313 left.

Best.-Nr.: 700.3650

Visierung siehe Zubehör.

Weitere Modellvarianten siehe Individualprogramm. Die dort angebotenen Wechselschäfte und Wechselsysteme können kombiniert werden.

Sight sets see Accessories.

Further model versions can be selected from the components of our individual offer. The listed stocks and barreled actions can be combined.



↑
Gewichtsstein 2013-U82, 75 g.
Weight 2013-U82, 75 g.
Best.-Nr.: 711.3011



↑
Pistolengriff Bunt, natur/blau
Pistol grip color, natural/blue
Best.-Nr.: 705.7826 Large.
Best.-Nr.: 705.7821 Medium.
Pistolengriff PRO-Grip, schwarz
Pistol grip PRO-Grip, black
Best.-Nr.: 705.7900 Large.
Best.-Nr.: 705.7905 Medium.
Pistolengriff Bunt, blau, links
Pistol grip color, blue, left hand version
Best.-Nr.: 705.7835 Large.
Best.-Nr.: 705.7830 Medium.

NEW AUFLAGE BENCHREST



51 1913 im Schaft 2213 AUFLAGE Alu, natur/blau.
Abbildung mit Visierung 7020 und Visierverlängerung 200 mm.
1913 with stock 2213 aluminum, natural/blue.
Picture with sight set 7020 and sighting line extension 200 mm.
Best.-Nr.: 202.5876 Griffgröße L · Grip size L

Vorderschafterhöhung Auflage
Fore-end raiser block benchrest

Korntunnel
Front sight

Schwerer Präzisions-Matchlauf
Heavy precision match barrel



Handstopp
Hand stop

Profilschiene
Grooved rail

Vorderschafterhöhung
Fore-end raiser block

50 1913 im Schaft 2213 Alu, natur/blau.
Abbildung mit Visierung 7020.
1913 with stock 2213 aluminum, natural/blue.
Picture with sight set 7020.
Best.-Nr.: 202.5875 Griffgröße L · Grip size L

**NEW Neue Farbe
New color**

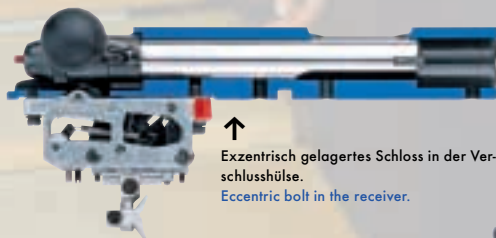

↑
Exzentrisch gelagertes Schloss in der Verschluss­hülse.
Eccentric bolt in the receiver.



52 1913 links im Schaft 2313 links Alu, silber/blau mit Adapter 4980.
Abbildung mit Visierung 7020L.
1913 left with stock 2313 left aluminum, silver/blue with adapter 4980.
Picture with sight set 7020L.
Best.-Nr.: 202.5885 Griffgröße L · Grip size L

Modell 2013/690 im Schaft 2313 Alu - High-Tech pur

Model 2013/690 Small Bore Target Rifle in stock 2313 Alu



KK-Modell 2013/690 im Schaft 2313 Alu, natur/blau:

System:

- Schwere, rechteckige Verschlusshülse.
- Massivere Ausführung.
- Kompakte System-/Schaftverbindung durch 4 Systembefestigungsschrauben.
- Grosse Bettungsfläche.
- Sehr lange Lauflagerung.
- Lauflänge 690 mm.

Schaft:

- Alu-Schaft.
- Mit vielseitiger Alu-Kappen- und Backenverstellung.
- Extrem flacher Vorderschaft, dadurch tiefere Laufflage beim Liegend- und Knieendschiessen möglich.
- Pistolengriff nach vorne und hinten verstellbar sowie schwenk- und drehbar.
- Mit Vorderschafterhöhung für Stehend-schiessen.

Lieferumfang:

Handstopp 4752, Vorderschafterhöhung, Schraubendreher, Innensechskantschlüssel, Bedienungsanleitung und Original-Schussbild.

Visierung siehe Zubehör.

Weitere Modellvarianten siehe Individualprogramm. Die dort angebotenen Wechselschäfte und Wechselsysteme können kombiniert werden.

NEW Neue Farbe
New color

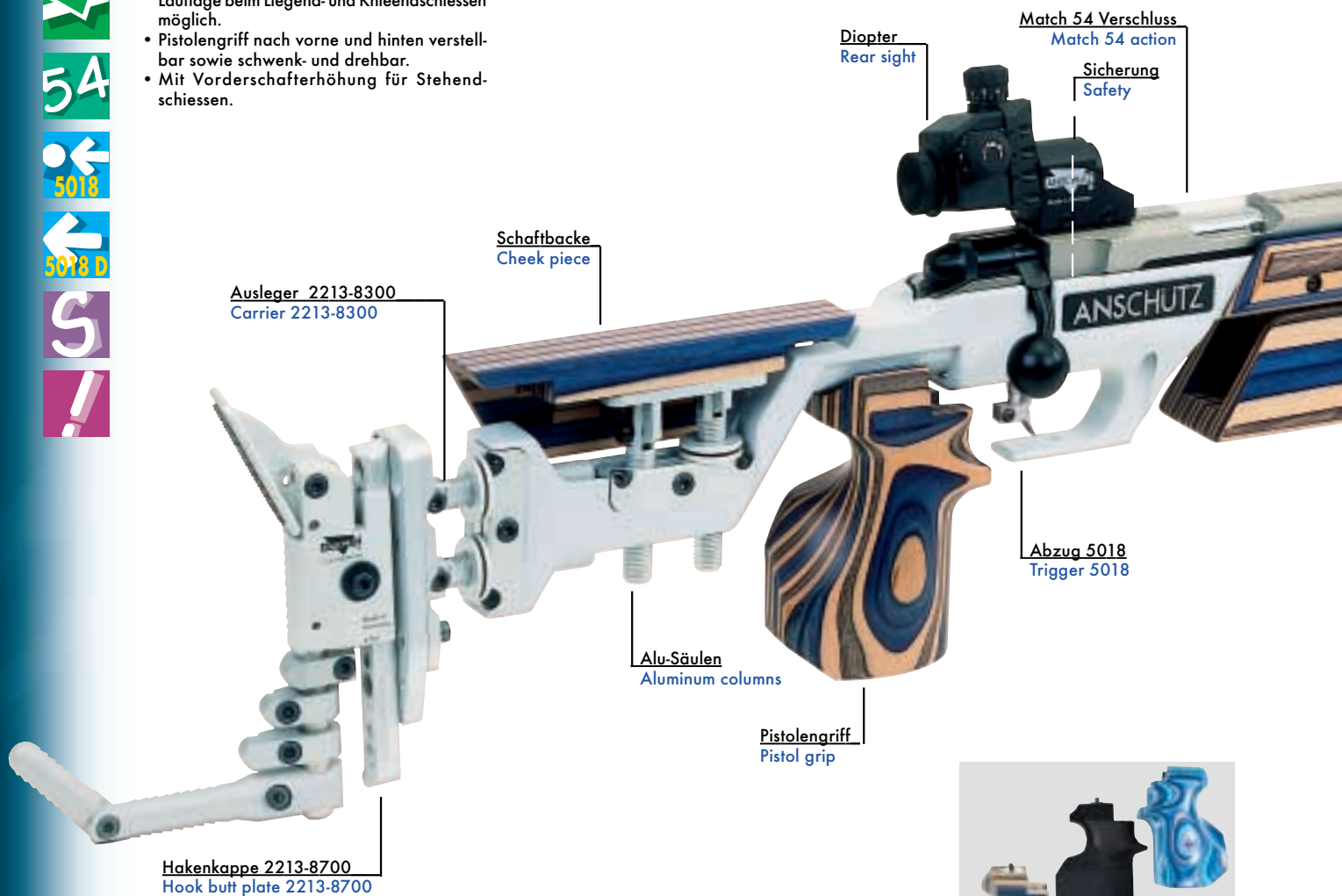
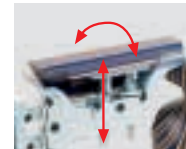

Small bore model 2013/690 in stock 2313 Alu Color:

Barreled action:

- Heavy rectangular receiver.
- Massive version.
- Compact connection of barreled action and stock by 4 barreled action bedding screws.
- Very long barrel bedding.
- Barrel length 690 mm.

Stock:

- Aluminum stock.
- With multiple adjustable aluminum butt plate and cheek piece adjustment.
- Extremely flat fore-end therefore lower barrel position for prone and kneeling possible.

- Pistol grip cantable from side to side and adjustable from front to rear.
- With fore-end raiser block for standing position.

Delivered with:

Hand stop 4752, fore-end raiser block, screw driver, Allan key, manual and test target.

Sight sets see Accessories.

Further model versions can be selected from the components of our individual offer. The listed stocks and barreled actions can be combined.



Pistolengriff Bunt, natur/blau
Pistol grip color, natural/blue

Best.-Nr.: 705.7826 Large.

Best.-Nr.: 705.7821 Medium.

Pistolengriff PRO-Grip, schwarz

Pistol grip PRO-Grip, black

Best.-Nr.: 705.7900 Large.

Best.-Nr.: 705.7905 Medium.

Pistolengriff Bunt, blau, links

Pistol grip color, blue, left hand version

Best.-Nr.: 705.7835 Large.

Best.-Nr.: 705.7830 Medium.



↑
Kappenausleger 2213-8300,
mit schwenkbarer Säulenführung.
Carrier 2213-8300,
with filling column guide.
Best.-Nr.: 700.3563



↑
Hakenkappe 2213-8700,
kompl. mit Führungsplatte 2213-8510.
Hook butt plate 2213-8700,
complete with guide plate 2213-8510.
Best.-Nr.: 700.3569



↑
Alu Führungsplatte 2213-8510,
komplett.
Alu guide plate 2213-8510,
complete.
Best.-Nr.: 700.3568

Korntrichter
Front sight



Schwerer Präzisions-Matchlauf
Heavy precision match barrel

Profilschiene
Grooved rail

Handstopp
Hand stop

Vorderschaftserhöhung
Fore-end raiser block

53 2013/690 im Schaft 2313 Alu, natur/blau.
Abbildung mit Visierung 7020.
2007/660 with stock 2313 aluminum, natural/blue.
Picture with sight set 7020.
Best.-Nr.: 200.5875 Griffgröße L · Grip size L



↑
Gewichtsstein 2013-U82, 75 g.
Weight 2013-U82, 75 g.
Best.-Nr.: 711.3011



↑
Vorderschaftserhöhung 2213-8500,
47 mm hoch, 170 mm lang, natur/blau.
Fore-end raiser block 2213-8500,
47 mm high, 170 mm long, natural/blue.
Best.-Nr.: 700.3633
Best.-Nr.: 700.3623 blau/blue
Best.-Nr.: 700.3629 schwarz/black



↑
Vorderschaftserhöhung 2213-8550,
24 mm hoch, 315 mm lang, natur/blau.
Fore-end raiser block 2213-8550,
24 mm high, 315 mm long, natural/blue.
Best.-Nr.: 700.3634
Best.-Nr.: 700.3624 blau/blue
Best.-Nr.: 700.3625 schwarz/black

Für Gewichte - for weights

Das Individual-Programm

The Individual Offer

1913

Unsere Wechselsysteme bieten mehrere Kombinationsmöglichkeiten mit Wechselschäften. Linksausführungen sind mit **L** gekennzeichnet.

Our barreled actions can be combined with various stocks. The models marked with **L** are available in left hand version.

Die 1913 Wechselsysteme sind auch mit den 1907/1912/2213 Wechselschäften kombinierbar.

The 1913 barreled actions can be combined with the 1907/1912/2213 stocks.



1913-U2



L 1913L-U2

Best.-Nr.: Item No.	Modell Model	Hinweis Note	Kaliber Caliber	Geschossführung/Lauflänge Rifling/Barrel length	Gewicht ca. Weight approx.
202.0990	1913 - U2	Druckpunktabzug · two stage trigger	.22 l.r.	69 cm / 69 cm · 27.1" / 27.1"	3,1 kg / 6.8 lbs
202.1990	1913L - U2	Druckpunktabzug · two stage trigger	L .22 l.r.	69 cm / 69 cm · 27.1" / 27.1"	3,1 kg / 6.8 lbs



Best.-Nr.: Item No.	Modell Model	Hinweis Note
705.0343	1913-U4/2	Nuss natur · Walnut non-stained
705.0353*	1913L-U4/2	Nuss · Walnut L
705.0330	1912-U4	Nuss natur · Walnut non-stained
705.0350*	1912L-U4	Nuss natur · Walnut non-stained L
705.5865	2213	Natur/blau, Griffgröße M Natural/blue, grip size M
705.5870	2213	Natur/blau, Griffgröße L Natural/blue, grip size L
705.5878	2213 AUFLAGE BENCHREST	Natur/blau, Griffgröße L Natural/blue, grip size L
705.5872*	2213	Silber/schwarz, Griffgröße M Silver/black, grip size M
705.5871*	2213	Silber/schwarz, Griffgröße L Silver/black, grip size L

2013 · 2013/690



2013-U6



2013/690-U6

Best.-Nr.: Item No.	Modell Model	Hinweis Note	Kaliber Caliber	Geschossführung/Lauflänge Rifling/Barrel length	Gewicht ca. Weight approx.
200.0990	2013 - U6	Druckpunktabzug · two stage trigger	.22 l.r.	50 cm / 69 cm · 19.6" / 27.1"	3,1 kg / 6.8 lbs
200.0890	2013/690 - U6	Druckpunktabzug · two stage trigger	.22 l.r.	69 cm / 69 cm · 27.1" / 27.1"	3,4 kg / 7.4 lbs

Best.-Nr. Item No.	Modell Model	Hinweis Note	Alu-Bunt Alu color
705.5880	2313	Natur/blau, Griffgröße M Natural/blue, grip size M	
705.5875	2313	Natur/blau, Griffgröße L Natural/blue, grip size L	
705.5877*	2313	Silber/schwarz, Griffgröße M Silver/black, grip size M	
705.5876*	2313	Silber/schwarz, Griffgröße L Silver/black, grip size L	
705.5890	2313L	Silber/blau, Griffgröße M Silver/blue, grip size M	L
705.5885	2313L	Silber/blau, Griffgröße L Silver/blue, grip size L	L

Der Wechselschaft 2313L kann mit dem Adapter 4980 auch mit den Wechselsystemen 1913L-U2 und 1907L-U6 kombiniert werden.
The stock 2313L and the barreled actions 1913L-U2 / 1907L-U6, can be combined with adapter 4980.

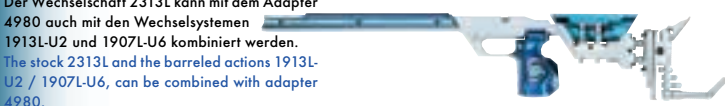

Best.-Nr. Item No.	Modell Model	Hinweis Note
705.0403*	2007 - U60	Nuss natur mit ALU-Schaftkappe 4759 Walnut non-stained with ALU butt plate 4759



Match-Abzüge
Match Triggers

ANSCHÜTZ Match-Abzüge - Kernstück unserer Matchgewehre

ANSCHÜTZ Match Triggers

ANSCHÜTZ-Match-Abzüge tragen wesentlich zum Erfolg aller ANSCHÜTZ-Matchwaffen bei. Die bekannt hohe Präzision garantiert eine gleichmässige Abzugscharakteristik. Die vielfachen Einstellmöglichkeiten sind herausragende Eigenschaften, die alle Anforderungen erfüllen, die Sportschützen auf der ganzen Welt an ein modernes Abzugssystem stellen. Mit unseren Abzügen lässt sich die bekannt hohe Schusspräzision der ANSCHÜTZ-Matchgewehre voll zum Einsatz bringen.

Alle Abzüge von Modell 5018 bis 5023 sind untereinander in der Innenmechanik baugleich, jedoch auf verschiedene Abzugsgewichte eingestellt.

Die Abzugsmodelle 5071 bis 5075 haben einen anderen Fanghebel gegenüber den oben beschriebenen Abzugsmodellen.

Alle Abzüge sind mit einem stufenlos verstellbaren Abzugsnocken ausgerüstet, für den je nach Verwendungszweck unterschiedliche Abzugsgewichte einstellbar sind.

ANSCHÜTZ match triggers are a big part in the success of all ANSCHÜTZ target rifles. The high grade of accuracy guarantees consistent trigger properties. The various adjusting properties are extra-ordinary characteristics which meet all requirements of target shooters around the world:

All triggers of the models 5018 to 5023 have the same design but have different trigger weights. The triggers model 5071 to 5075 have a different catch in contrast to the models mentioned above.

All models have a variably adjustable trigger cam. The trigger weight of the cam can be adjusted to various trigger weights depending on the desired use.



Für Modelle - for models
1907, 1913, 2007, 2013.



Trainingsschlagbolzen 1807T-12,
inkl. Feder und Federstütze.

Firing pin for training 1807T-12,
incl. spring and spring support.

Best.-Nr.: 700.6901

Trainingsschlagbolzen 1807T-12,
ohne Feder und Federstütze.

Firing pin for training 1807T-12,
without spring and spring support.

Best.-Nr.: 700.6900 Ohne Abbildung.
Without picture.

Schlagbolzen 1807-12,
inkl. Feder und Federstütze.

Firing pin 1807-12,
incl. spring and spring support.

Best.-Nr.: 700.6906 Ohne Abbildung.
Without picture.

Schlagbolzen 1807-12,
ohne Feder und Federstütze.

Firing pin 1807-12,
without spring and spring support.

Best.-Nr.: 700.6905 Ohne Abbildung.
Without picture.

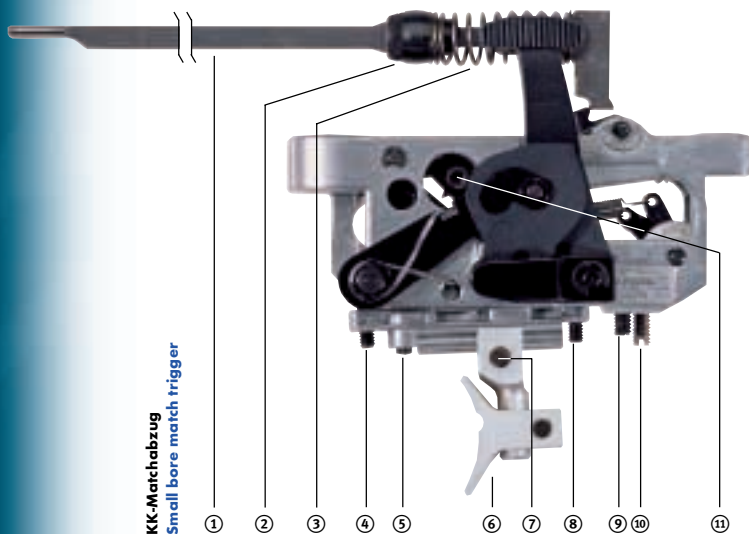

KK-Matchabzug
Small bore match trigger

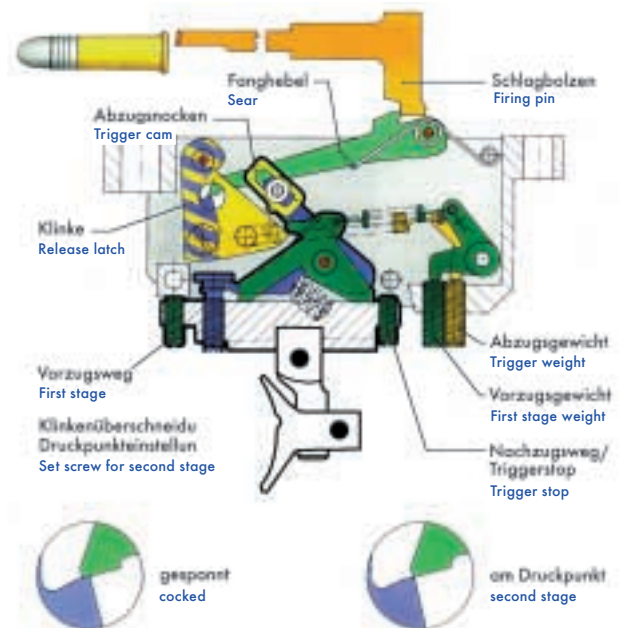

Kürzeste Schussentwicklungszeit durch das KK-Matchabzugssystem mit Schlagbolzen.

- ① Schlagbolzen.
- ② Federstütze.
- ③ Schlagbolzenfeder.
- ④ Einstellschraube für den Vorzug.
- ⑤ Einstellschraube für den Druckpunkt.
- ⑥ Abzugszüngel.
- ⑦ Klemmschraube.
- ⑧ Einstellschraube für den Triggerstopp.
- ⑨ Einstellschraube für das Vorzugsgewicht.
- ⑩ Einstellschraube für das Abzugsgewicht.
- ⑪ Verstellbarer Abzugsnocken.

Very short locktime through small bore match trigger mechanism with firing pin.

- ① Firing pin.
- ② Spring support.
- ③ Firing pin spring.
- ④ Set screw for first stage.
- ⑤ Set screw for second stage.
- ⑥ Trigger blade.
- ⑦ Hex screw.
- ⑧ Set screw for trigger stop.
- ⑨ Set screw for first stage weight.
- ⑩ Set screw for trigger weight.
- ⑪ Adjustable trigger cam.

**Luftgewehr Match-Abzüge für Modelle
9003 Premium und 8002 Pressluft:**

**Air Rifle Match triggers for Models
Premium und 8002 Compressed Air:**

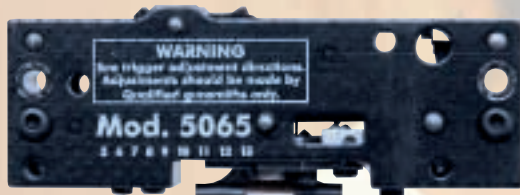

↑
**Druckpunkt-Abzug 5065 A.
Two stage trigger 5065 A.
Best.-Nr.: 700.6680**



↑
**Druckpunkt-Abzug 5065 B.
Two stage trigger 5065 B.
Best.-Nr.: 700.6681***

LG-Matchabzug
Compressed air match trigger

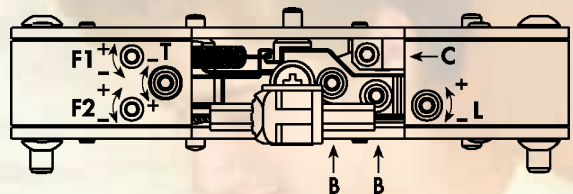
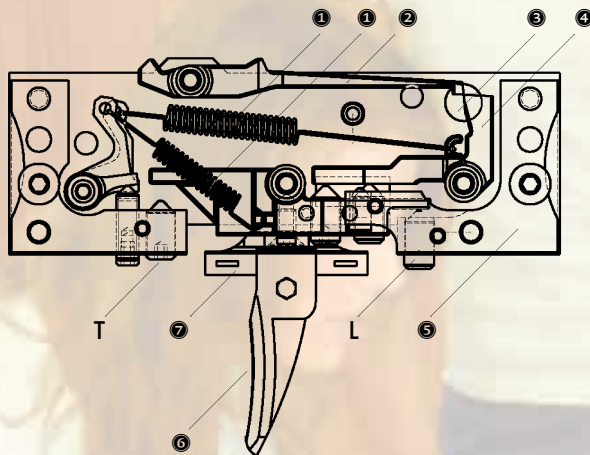

**Die neuen Abzüge 5065 A und 5065 B
setzen Maßstäbe im Luftgewehrbereich.**

**The new triggers 5065 A and 5065 B
are trend-setting in air rifle shooting.**

- ① Zugfeder.
- ② Fanghebel.
- ③ Sichtfenster.
- ④ Klinke.
- ⑤ Abzugsgehäuse.
- ⑥ Abzugszüngel.
- ⑦ Abzugswippe.
- F1 Vorzugsgewicht.
- F2 Abzugsgewicht.
- T Nachzugsweg.
- L Vorzugsweg.
- B Werksgrundeinstellung / versiegelt.
- C Werksgrundeinstellung / versiegelt.

- ① Tension spring.
- ② Sear.
- ③ View window.
- ④ Release latch.
- ⑤ Trigger housing.
- ⑥ Trigger blade.
- ⑦ Trigger support.
- F1 First stage weight.
- F2 Trigger weight.
- T Trigger stop.
- L First stage.
- B Company adjusted / sealed.
- C Company adjusted / sealed.



↑
**Abzugsschuh 5080-U1.
Trigger shoe 5080-U1.
Best.-Nr.: 700.6200***



↑
**Abzugszüngel, vielseitig
verstellbar.
Trigger blade, adjustable.
Best.-Nr.: 700.6201**



↑
**Abzugszüngel.
Trigger blade.
Best.-Nr.: 700.6202***

ANSCHÜTZ Match-Abzüge

ANSCHÜTZ Match Triggers

Best.-Nr. Item No.	Modell Model	Druckpunkt-Abzug Two stage trigger	Direkt-Abzug Single stage trigger	Eingestellt auf Adjusted to	Rechtsausführung Right hand version	Linksausführung Left hand version	Für Modelle For models	Für KK-Herstellungs- jahre For small bore models production years	Für KK-Serien-Nr. ab For small bore models serial No. starting from
700.6550	5071/1	●		100 g	●		1607, 1613, 1608 EDS	1974 - 1979	143655 bis · to 182155
700.6560	5071/1 D		●	100 g	●				
700.6570	5075/1	●		550 g	●				
700.6580	5075/1 D		●	550 g	●				
700.6600	5018	●		100 g	●		1807, 1907, 1807 Z, 1907 Z, 1907 Silh., 1807 Rep., 1907 Rep., 1907 Rep., 1912, 1813, 1913, 1808 EDS, 1808 D-RT, 1827, 1827F, 2007, 2007/660, 2012, 2013, 2013/690, 2013 Benchrest, 54.18 MSR, 1808 MSR, 2020, 2025, 2002 Compr. Air, 2002 D-RT Compr. Air	ab starting from 1979	ab starting from 182156
700.6610	5018 L	●		100 g		●			
700.6620	5018 D		●	150 g	●				
700.6630	5018 L D		●	150 g		●			
700.6640	5020	●		550 g	●				
700.6650	5020 L	●		550 g		●			
700.6660	5020 D		●	550 g	●				
700.6670	5020 L D		●	550 g		●			
700.6740	5022	●		1500 g	●				
700.6800	5098	●		230 g	●		1903, 1416 MSP, 1403 Rep., 64 MSR, 64 MPR, 64 R		
700.6810	5098 L	●		230 g		●			
700.6860	5100 D		●	500 g	●				
700.6870	5100 L D		●	500 g		●			
700.6875	5103	●		1500 g	●				
700.6876	5104	●		550 g	●				
700.6877	5104 L	●		550 g		●			
700.6700	5019	●		100 g	●		2001 Super Air		
700.6710	5021 D		●	550 g	●		2001 D-RT Super Air		
700.6720	5021	●		100 g	●		2002 Super Air		
700.6730	5023 D		●	550 g	●		2002 D-RT Super Air		
700.6680	5065 A	●		100 g	●		9003 Premium, 8002 Compr. Air		
700.6681	5065 B	●		100 g	●		9003 Premium, 8002 Compr. Air		

L	= Linksausführung	Left hand version
D	= Direktabzug	Single stage trigger
D-RT	= Laufende Scheibe	Running Target
Rep.	= Mehrlader	Repeater
Silh.	= Silhouette	Silhouette
F	= Fortner	Fortner
Z	= Zimmerstutzen	"Zimmerstutzen"
MS	= Silhouette	Silhouette

Bei der Bestellung von Abzügen nennen Sie bitte neben der Bestellnummer unbedingt auch das Abzugsmodell und das Gewehrmodell. Linksausführungen ergänzen Sie bitte mit "L".

When you order trigger parts please indicate the order number, type of rifle model together with the trigger model number. For left hand versions please add "L".



Zubehör-Programm
Accessories

ANSCHÜTZ Zubehör-Programm

ANSCHÜTZ Accessories

Das richtige Zubehör macht noch mehr aus Ihrem ANSCHÜTZ-Matchgewehr:

Auf den folgenden Seiten finden Sie unser komplettes, aktuelles Zubehör-Angebot.

Perfektion ist gefragt – mit ANSCHÜTZ-Match-Sportgeräten und dem umfangreichen Original-ANSCHÜTZ-Zubehör-Programm sind Sie bestens gerüstet.

Die MEISTER MACHER.
Mit meisterlichem Zubehör.

The correct accessories make even more out of your ANSCHÜTZ target gun:

On the following pages you will find our complete, current accessories.

Perfection wanted – You are very well equipped with original ANSCHÜTZ accessories.

The "MEISTER MACHER".
With master-grade accessories.

Veränderung der Treffpunktlage von Raste zu Raste des Universal-Diopters 7002: Universal micrometer rear sight. Changing the point of impact position from click to click:

	10er Klick · clicks	20er Klick · clicks
10 m	0,4 mm	0,2 mm
15 m	0,6 mm	0,3 mm
50 m	2,0 mm	1,0 mm
100 m	4,0 mm	2,0 mm

Bei einer Umdrehung 10er Klick bzw. 20er Klick. At one turn 10 clicks or 20 clicks.



↑
Visierung 7020/10, mit Diopter 7002/10, 10er Klick / Umdrehung, Korntunnel 6832 und 7 Korne.
Sight set 7020/10 with rear sight 7002/10, 10 clicks, front sight 6832 and 7 inserts.

Best.-Nr.: 700.0070

Visierung 7020/20 wie 7020/10 jedoch 20er Klick / Umdrehung.
Sight set 7020/20 like 7020/10 but 20 clicks / at one turn.

Best.-Nr.: 700.0071

Visierung 7020 L/10 wie 7020/10 jedoch Linksausführung.
Sight set 7020 L/10 like 7020/10 but left hand version.

Best.-Nr.: 700.0075

Visierung 7020 L/20 wie 7020/20 jedoch Linksausführung.
Sight set 7020 L/20 like 7020/20 but left hand version.

Best.-Nr.: 700.0076



↑
Visierung 6834, Diopter 6805, Korntunnel 6832 und 7 Korne.
Sight set 6834, rear sight 6805, front sight 6832 and 7 inserts.

Best.-Nr.: 700.0060



↑
Abdeckhülse 6586-20, aus Spezialkunststoff, schwarz, für Korntunnel.
Cover 6586-20, of special plastics, black, for front sight.

Best.-Nr.: 710.1220



↑
Visierung 6829, Diopter 6809, Korntunnel 6832 und 7 Korne.
Sight set 6829, rear sight 6809, front sight 6832 and 7 inserts.

Best.-Nr.: 700.0055

Für ANSCHÜTZ LaserPower und alle ANSCHÜTZ KK-Modelle ausser Modell 1903.
For ANSCHÜTZ LaserPower and all ANSCHÜTZ small bore target rifles except model 1903.



↑
Dioptersatz Biathlon 6827. Biathlon rear sight set 6827.

Best.-Nr.: 700.0050



↑ **Universal Mikrometerdiopter 7002/10, schwenkbar**, Höhen- und Seitenverstellung durch Raster-schrauben. 10er Klick / Umdrehung.

Universal micrometer rear sight 7002/10, vertically and horizontally adjustable by click screw. 10 clicks.

Universal Mikrometerdiopter 7002/20, schwenkbar, wie 7002/10 jedoch mit 20er Klick / Umdrehung.

Universal micrometer rear sight 7002/20, like 7002/10 but with 20 clicks per turn.

Universal Mikrometerdiopter 7002L/10, schwenkbar, wie 7002/10 jedoch Linksausführung.

Universal micrometer rear sight 7002L/10, like 7002/10 but left hand version.

Universal Mikrometerdiopter 7002L/20, schwenkbar, wie 7002/20 jedoch Linksausführung.

Universal micrometer rear sight 7002L/20, like 7002/20 but left hand version.

Für ANSCHÜTZ LaserPower und alle ANSCHÜTZ KK-Modelle ausser Modell 1903.
For ANSCHÜTZ LaserPower and all ANSCHÜTZ small bore target rifles except model 1903.



↑ **Gummiblende 6700-20. Anti-glare tube 6700-20.**
Best.-Nr.: 710.1200*



↑ **Linse 6852-03, mit 0,3er Dioptrie. Lens 6852-03, with 0.3 diopter.**
Best.-Nr.: 710.1120

Linse 6852-05, mit 0,5er Dioptrie. (entspricht 1,5-facher Vergrößerung). Lens 6852-05, with 0.5 diopter. (enlarged 1.5 times).
Best.-Nr.: 710.1130



↑ **Verlängerung für Diopterblende 1827F-55. Rear sight extension 1827F-55.**
Best.-Nr.: 710.3024



↑ **Präzisionsdiopter 6805, mit Gegenlichtblende. Rear sight 6805, with anti-glare tube.**
Best.-Nr.: 700.0115



↑ **Präzisionsdiopter 6809, Höhen- und Seitenverstellung durch Rasterschrauben. Rear sight 6809, vertically and horizontally adjustable by click screw.**
Best.-Nr.: 700.0114



↑ **Spezialdiopter 6807, mit Schneeklappe. Special rear sight 6807, with snow cap.**
Best.-Nr.: 700.0150



↑ **Dreieckskorn für LP@ ANSCHÜTZ. Triangular front sight for LP@ ANSCHÜTZ.**
Best.-Nr.: 711.3710



↑ **Diopterscheibe 6850-U6, (Ersatz für 6702-U5), Ø 1,1 mm, mit Blendenhalter. Peep sight disc aperture 6850-U6, (replacing 6702-U5), Ø 1.1 mm, with clamping ring.**
Best.-Nr.: 700.0300



↑ **Rotpunkt Visier 1 x 20. Red dot sight 1 x 20.**
Best.-Nr.: 716.1002



↑ **Zielfernrohr 4 x 20. Telescopic sight 4 x 20.**
Best.-Nr.: 716.1003

ANSCHÜTZ Zubehör-Programm

ANSCHÜTZ Accessories



← **Ohne Polarisationsfilter:**
 Unscharfe Zielscheibe durch Luftspiegelungen.
 Reflexionen, Mirage durch aufsteigende wärmere Luft
Without polarisation filter:
 Unfocussed target due to mirage. Reflections,
 mirage due to rising warm air.



← **Mit Polarisationsfilter:**
 Luftspiegelungen. Reflexionen werden ausgefiltert.
With polarisation filter:
 Reflections are filtered out.

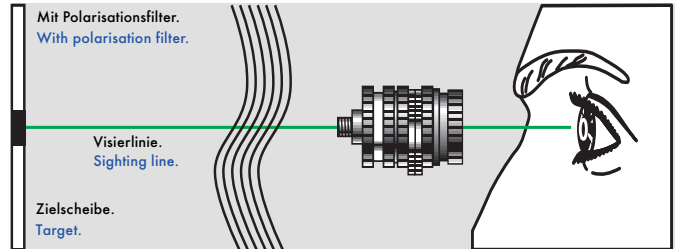
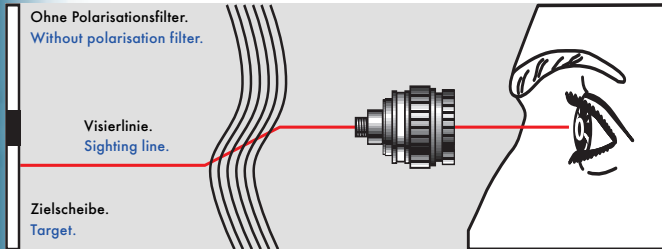

↑ **Kompakt-Irisblende 6781,**
 mit 5-Farb- und Polarisationsfilter.
 Filter: gelb, grün, 3 Graustufen.
Compact iris aperture 6781,
 with 5-color and polarisation filter.
 Filter: yellow, green, 3 greys.
Best.-Nr.: 700.1050



↑ **Kompakt-Irisblende 6775,**
 verstellbar.
Compact iris aperture 6775,
 adjustable.
Best.-Nr.: 700.1060



↑ **Irisblende 6779,** mit 5-Farbfilter,
 gelb, grün, 3 Graustufen.
Iris aperture 6779, with 5 color
 filter, yellow, green, 3 greys.
Best.-Nr.: 700.1030

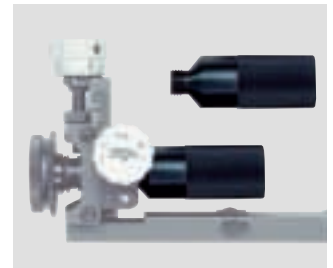

↑ **Gegenlichtblende 6765,**
 für 6702, 6802.
Anti-glare tube 6765,
 for 6702, 6802.
Best.-Nr.: 700.1250*

ANSCHÜTZ Super-Irisringkorn:
 Zur optimalen Einstellung auf Lichtverhältnisse und Scheibengrößen beim Wettkampf kann der Durchmesser des ANSCHÜTZ Super-Irisringkorns stufenlos von 2,8 bis 4,8 mm verstellbar werden. Die Ringbreite bleibt dabei **konstant (siehe Abbildung)**. Das Durchsichtsbild kann mit einem mitgelieferten Werkzeug von **Fadenkreuz auf Querbalken** verstellbar und somit den Wünschen des Schützen individuell angepasst werden. Dieses Ringkorn wird zusätzlich mit einem größeren Rändelring geliefert, um das Zielbild besser abdecken zu können. Das ANSCHÜTZ Super-Irisringkorn wird mit Einschraubgewinde **M18 x 0,5** geliefert.

ANSCHÜTZ Iris Aperture:
 Provides instantly the optimum adjustments for any light conditions and target sizes during competition. The radius of the ANSCHÜTZ iris aperture globe front sight can be **continuously adjusted** from 2.8 to 4.8 mm without changing the size of the ring. In addition, the peep picture can be **changed from cross hair to lateral hair** at the discretion of the shooter. This ANSCHÜTZ aperture globe front sight is also supplied with a larger knurled ring which can be optionally used for a larger target picture. The ANSCHÜTZ aperture globe front sight is delivered with a **M18 x 0.5** mm screw thread.

ANSCHÜTZ Super-Irisglasringkorn:
 Wie unser bewährtes Super-Irisringkorn Modell 9740 hat auch das ANSCHÜTZ Super-Irisglasringkorn einen extrem grossen Verstellbereich, der durch die einzigartige 2-Zangen-Konstruktion der Iris ermöglicht wird. Das Super-Irisglasringkorn wird einfach in den Korntunnel geschraubt und ist **stufenlos verstellbar**.

ANSCHÜTZ Glass Aperture:
 Like our iris aperture model 9740 this aperture has an extremely wide range of adjustment due to the design of the iris with 2 pliers. The aperture is screwed on to the front sight. It is **variably adjustable**.



← **Super-Irisringkorn 9740,**
 2,8-4,8 mm Ø, verstellbar.
Super-Iris aperture globe front sight 9740,
 2.8-4.8 mm Ø, adjustable.
Best.-Nr.: 710.1100



← **Super-Irisglasringkorn 9744,**
 2,8-4,8 mm Ø, verstellbar.
Super-Iris glass aperture globe front sight 9744,
 2.8-4.8 mm Ø, adjustable.
Best.-Nr.: 710.1101

ANSCHÜTZ Duo-Ringkorn:

Das ANSCHÜTZ Duo-Ringkorn lässt sich **stufenlos im Innen- und Auswendurchmesser verstellen** und bietet dadurch optimale Einstellmöglichkeiten auf die jeweilige Scheiben-grösse oder Lichtverhältnisse.

Durch seinen extrem grossen Verstellbereich kann das Duo-Ringkorn bei allen Disziplinen eingesetzt werden. Das ANSCHÜTZ-Duo-Ringkorn gibt es in 2 Ausführungen als freistehendes **Glaskorn 9760** sowie als **Fadenkreuz 9750**. Das Durchsichtsbild beim Fadenkreuzringkorn lässt sich wie bei Mod. 9740 bei Luftgewehrdisziplinen auf **Querbalken** umschalten.

ANSCHÜTZ Duo-iris aperture:

The inner and the outer diameter of the ANSCHÜTZ Duo-iris aperture can be smoothly adjusted to meet all requirements of target size or light conditions. With the extremely high range of adjustment the aperture can be used for all shooting disciplines. The ANSCHÜTZ Duo-iris aperture is available in two versions: As clear **glass aperture 9760** and as **cross hair 9750**. Like in the model 9740 a change from cross hair to **lateral hair** is possible for air rifle disciplines.



↑ **Duo-Ringkorn 9750**, mit Fadenkreuz/Querbalken, 2,8 - 4,8 mm innen Ø, verstellbar, 6,4 - 9,0 mm aussen Ø, verstellbar.



↑ **Duo-Ringkorn 9760**, mit Glaskorn, 2,8 - 4,8 mm innen, verstellbar, 6,4 - 9,0 mm aussen verstellbar.

Duo iris aperture 9750, with cross/ lateral hair, 2.8 - 4.8 mm inner Ø, adjustable, 6.4 - 9.0 mm outer Ø, adjustable. **Best.-Nr.: 710.1140**

Duo iris aperture 9760, with glass aperture, 2.8 - 4.8 mm inner Ø, adjustable, 6.4 - 9.0 mm outer Ø, adjustable. **Best.-Nr.: 710.1145***



↑ **Ringkorn Vario Swing 9736**, 2,5 - 5,0 mm Ø, verstellbar. **Vario Swing iris aperture 9736**, 2.5 - 5.0 mm Ø, adjustable. **Best.-Nr.: 710.1116**



↑ **Korntunnel 6832**, radial schwenkbar. **Front sight 6832**, radially turnable. **Best.-Nr.: 700.0221**



↑ **Fuss 6586-U1/1**, von 6832, lose. **Base 6586-U1/1**, of 6832. **Best.-Nr.: 700.1342***



↑ **Kornsatz 6522-U20**, 7 Korne, Ø 3,2; 3,4; 3,6; 3,8; 4,0; 4,1; 4,3 mm. **Set of inserts 6522-U20**, 7 inserts, Ø 3.2; 3.4; 3.6; 3.8; 4.0; 4.1; 4.3 mm. **Best.-Nr.: 700.0510**



↑ **Satz Plastik-Lochkorne 6822-U14**, inkl. Klemmschraube u. Abdeckhülse 3,1/3,3/3,4/3,5/3,7/3,9/4,1/4,3 mm. **Set of plastic apertures 6822-U14**, incl. clamping screw and cap 3.1/3.3/3.4/3.5/3.7/3.9/4.1/4.3 mm. **Best.-Nr.: 700.1500**



↑ **Plastik-Lochkorne 6522-14**, einzeln, aus Spezial-Kunststoff, rosa. Von Ø 2,4 - 6,0 mm in 0,1 mm Schritten erhältlich. **Plastic apertures 6522-14**, of special plastics, pink. From Ø 2.4 - 6.0 mm in 0.1 mm steps available. **Best.-Nr.: 710.15xx**

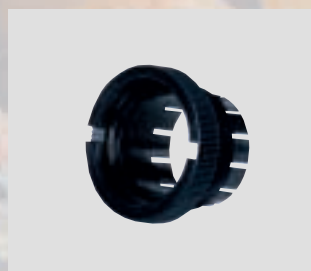

↑ **Klemmschraube 6822-12**, für Plastik-Lochkorne 6522-14. **Clamping screw 6822-12**, for plastic aperture 6522-14. **Best.-Nr.: 700.1320**

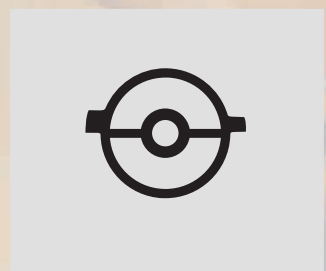

↑ **Ringkorn 6522-9**, Ø 1,8; 2,0; 2,2; 2,4 bis 4,6 mm. **Aperture insert 6522-9**, Ø 1.8; 2.0; 2.2; 2.4 to 4.6 mm. **Best.-Nr.: 700.05xx**



↑ **Wasserwaage 6930**, zum Aufstecken, gegen Verkantungsfehler. **Spirit level 6930**, prevents canting. **Best.-Nr.: 700.1302**



↑ **Wasserwaage 6830/1**, zum Einschrauben, gegen Verkantungsfehler. **Spirit level 6830/1**, prevents canting. **Best.-Nr.: 700.1301**



↑ **Korntunnelverlängerung 6835**, zum Einschrauben. **Front sight extension 6835**, to screw in. **Best.-Nr.: 700.1220**



↑ **Schutzkappen 6523-4**, weiss. **Protective cap 6523-4**, white. **Best.-Nr.: 710.1210**

* Nur solange Vorrat reicht - As long as available.

ANSCHÜTZ Zubehör-Programm

ANSCHÜTZ Accessories



Hohe · height: 8 mm

↑
Visierlinienerhöhung 6713/2, für Matchgewehre mit aufgeschraubtem Prisma, für Modelle 1407-1813.
Sight raiser block 6713/2, for target rifles with front sight prism, screwed on for models 1407-1813.

Best.-Nr.: 700.1260



Hohe · height: 8 mm

↑
Visierlinienerhöhung 6817, mit starker Klemmung, für Prismenfräsung 11 bis 13 mm.
Sight raiser block 6817, with strong clamping, for grooved receiver 11 to 13 mm.

Best.-Nr.: 700.1232



Hohe · height: 8 mm

↑
Dioptererhöhung 6817-U1, mit starker Klemmung, für Prismenfräsung 11 bis 13 mm.
Sight raiser block for rear sight 6817-U1, with strong clamping, for grooved receiver 11 to 13 mm.

Best.-Nr.: 700.1233



Hohe · height: 8 mm

↑
Korntunnelerhöhung 6817-U2, mit starker Klemmung, für Prismenfräsung 11 bis 13 mm.
Sight raiser block for front sight 6817-U2, with strong clamping, for grooved receiver 11 to 13 mm.

Best.-Nr.: 700.1234



Hohe · height: 8 mm

↑
Visierverlängerung für das Auflageschiessen, 200 mm. Eine optimale Kombination aus Visierlinienverlängerung und -erhöhung, speziell für das Auflageschiessen entwickelt. Der Blick durch die Visierung erfolgt durch den Auflageschützen grundlegend anders. Durch die Verlegung nach hinten und oben ist eine kompromisslose Anpassung an die unterschiedlichen Anschlagarten möglich. Für Modelle ab 1907 und nachfolgende und Luftgewehre ab 2001.

Sighting line extension for benchrest shooting, 200 mm. An optimum combination of sighting line extension and raiser block, especially developed for benchrest shooting. The benchrest shooter looks through the sight set in a completely different way. The sight set is moved back and is higher and thus allows for an optimum adaption to the various positions. For models 1907 and following and air rifles starting from 2001.

Best.-Nr.: 700.1224

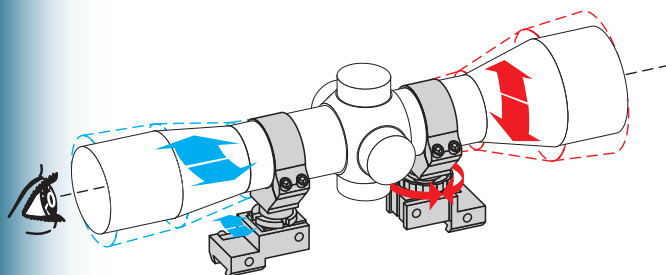

Beispiel · Sample

Visierverlängerung für das Auflageschiessen, 200 mm, für Modelle 1407-1813. Ohne Abbildung.
Sighting line extension for benchrest shooting, 200 mm, for models 1407-1813. Without picture.

Best.-Nr.: 700.1226



↑
Mündungsrohr 2013-U4, 246 mm lang, nur für Kurzläufe.
Muzzle tube 2013-U4, 246 mm long, only for short barrels.

Best.-Nr.: 003474

↑
Mündungsrohr 2013-57, 440 mm lang, nur für Kurzläufe.
Muzzle tube 2013-57, 440 mm long, only for short barrels.

Best.-Nr.: 007087*



↑
Aufschubmontage 5516/26-1, 2-teilig, 21 mm hoch, mit Ring-Ø 26 mm.
2-piece mount 5516/26-1, 21 mm high, with rings Ø 26 mm.

Best.-Nr.: 710.1600*



↑
Aufschubmontage 5516/30, 2-teilig, 21 mm hoch, mit Ring-Ø 30 mm.
2-piece mount 5516/30, 21 mm high, with rings Ø 30 mm.

Best.-Nr.: 710.1630*



↑
Aufschubmontage 5525/26-1, 2-teilig, 31 mm hoch, mit Ring-Ø 26 mm.
2-piece mount 5525/26-1, 31 mm high, with rings Ø 26 mm.

Best.-Nr.: 710.1610*



↑
Aufschubmontage 5525/30, 2-teilig, 31 mm hoch, mit Ring-Ø 30 mm.
2-piece mount 5525/30, 31 mm high, with rings Ø 30 mm.

Best.-Nr.: 710.1620*

Alu-Schaftkappe 4759/4758:

Für viele Sportschützen sind die Radien der Gummikappen zu gross. Daraus resultieren Anschlagfehler. Mit den Schaftkappen **Modell 4759 und Modell 4758** lässt sich dieses Problem leicht lösen. Die stufenlose Verstellung der Schulterweite (nur beim Modell 4759) und des Schwenkbereiches ermöglicht immer eine optimale Anpassung.

An gerade Hinterschäfte kann die Alu-Schaftkappe direkt angeschraubt werden.

Vorteile:

- Leichte, hochfeste Aluminiumkonstruktion.
- Sehr leicht einstellbar.
- Winkelverstellung direkt an der Alu-kappe und dadurch Vermeidung von Winkelfehlern.

- Entspricht den neuen ISSF-Regeln
- Vielseitig und individuell verstellbar.
- Bedienungsfreundliche Verstellelemente.
- Schnell reproduzierbare Einstellungen durch übersichtliche Skalen.
- Bei Modell 4759, Anti-Rutsch-Profil an der Schulerauflagefläche.
- Gerundete Kanten.
- Vertikal und horizontal verstellbar sowie seitlich schwenkbar.

Zusätzliche Einstellmöglichkeiten bei Modell 4759:

- Oberer Flügel direkt von vorne durch neuartige Klemmung im Winkel verstellbar (siehe Pfeil).
- Schulterweite einstellbar.
- Stufenlose Längsverstellung durch den Ausleger 4759-2000 mit Säulenführung und Anschlagmutter.

Alu Butt Plate 4759/4758:

For many shooters the radius at the butt plate is too large. The result is that the butt plate does not fit the shoulder correctly. The butt plate **models 4759 and model 4758** offer a solution for this problem. The variable adjustment of shoulder width (only model 4759) and tilting range allow a perfect fit. The aluminum butt plate can be screwed on directly to all stocks with straight stock ends.

The advantages:

- Light, extra strong aluminum design.
- Easy adjustments.
- Angle adjustments directly at the butt plate and therefore no angle errors.

- All butt plate adjustments correspond to the new ISSF rules.
- Variable and individual adjustments.
- Easy handling of adjustment elements.
- Scales for reproducing adjustments quickly.
- Model 4759, no slip profile in the shoulder area.
- Vertically and horizontally adjustable, can be tilted.

Further adjusting possibilities with model 4759:

- Upper wing angle directly adjustable from the front via new clam ping (see arrow).
- Adjustable shoulder width.
- Variable length adjustment by column guide 4759-2000 and stop nut.



↑ **Alu-Schaftkappe 4759**, inklusive Befestigungselemente, speziell für ANSCHÜTZ-Gewehre.
Alu butt plate 4759, incl. screws, especially for ANSCHÜTZ rifles.
Best.-Nr.: 700.3590



↑ **Alu-Schaftkappe 4758**, inklusive Befestigungselemente, speziell für ANSCHÜTZ-Gewehre.
Alu butt plate 4758, incl. screws, especially for ANSCHÜTZ rifles.
Best.-Nr.: 700.3592



↑ **Kappenverlängerung für 4759.**
Butt plate extension, for 4759.
Best.-Nr.: 700.9505

← **Alu-Schaftkappe Auflage 4759A**, inklusive Befestigungselemente, speziell für ANSCHÜTZ-Gewehre.
Alu butt plate Benchrest 4759A, incl. screws, especially for ANSCHÜTZ rifles.
Best.-Nr.: 700.3594

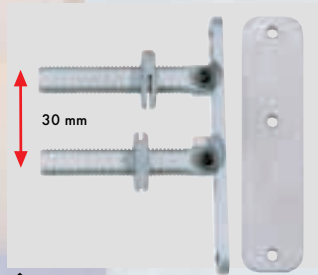

↑ **Kappenausleger 4759-2000**, 30 mm mit schwenkbarer Säulenführung.
Butt plate carrier 4759-2000, 30 mm, with tilting column guide.
Best.-Nr.: 700.3564

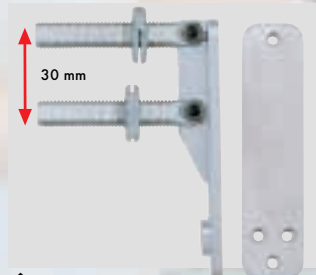

↑ **Kappenausleger 9003/8002**, mit schwenkbarer Säulenführung.
Butt plate carrier 9003/8002, with tilting column guide.
Best.-Nr.: 700.3573

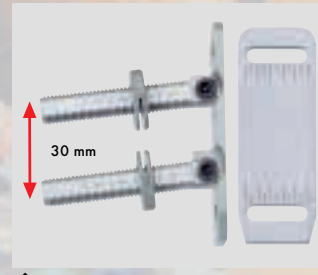

↑ **Kappenausleger 2213-8300**, mit schwenkbarer Säulenführung für KK-Aluschäfte.
Butt plate carrier 2213-8300, with tilting column guide for small bore alu stocks.
Best.-Nr.: 700.3563



↑ **Backenausleger 2213-8200**, 30 mm.
Cheek piece adjustment 2213-8200, 30 mm.
Best.-Nr.: 700.3562



↑ **Hakenkappe 4765-U4**, komplett mit Haken 4765-U3.
Hook butt plate 4765-U4, complete with hook 4765-U3.
Best.-Nr.: 700.3582



↑ **Hakenkappe 4765**, mit Führungsplatte 4760-U3a/1.
Hook butt plate 4765, complete with guide plate 4760-U3a/1.
Best.-Nr.: 700.3580*



↑ **Hakenkappe 2213-8700**, komplett mit Führungsplatte 2213-8510.
Hook butt plate 2213-8700, complete with guide plate 2213-8510.
Best.-Nr.: 700.3569



↑ **Haken 4765-U3**, komplett für Liegendkappe 4765-U9.
Hook 4765-U3, complete for prone butt plate 4765-U9.
Best.-Nr.: 700.3583

* Nur solange Vorrat reicht - As long as available.

ANSCHÜTZ Zubehör-Programm

ANSCHÜTZ Accessories

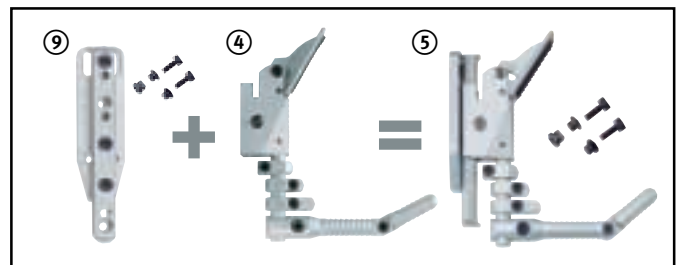
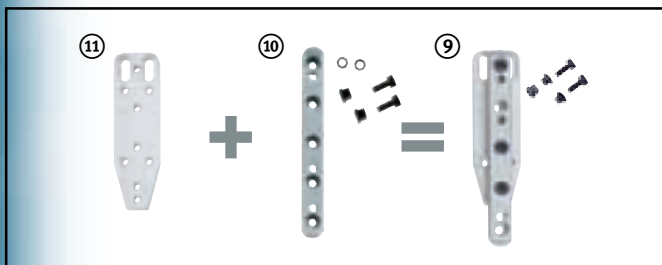
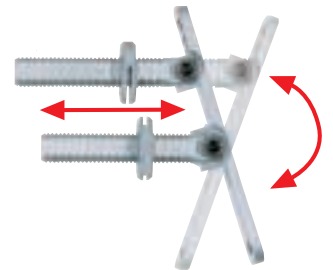
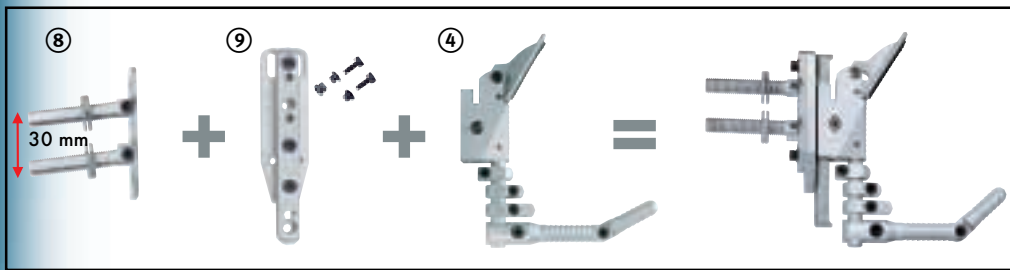
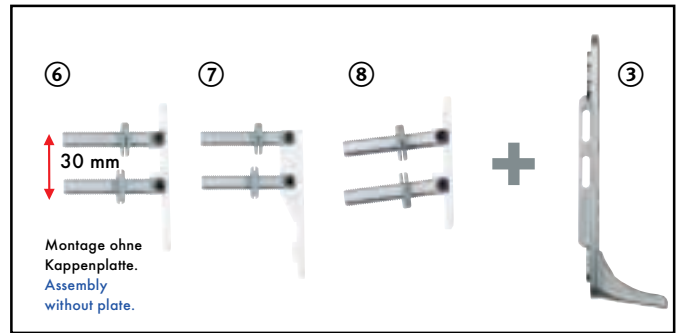
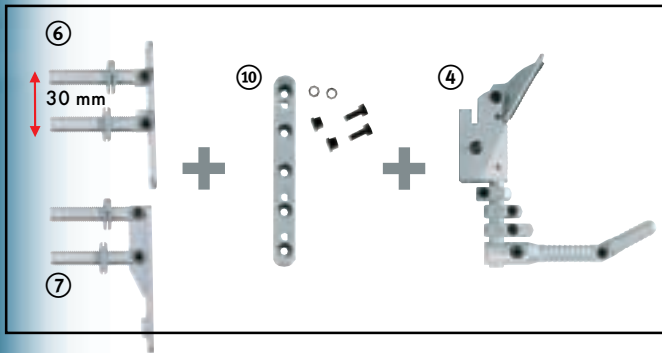
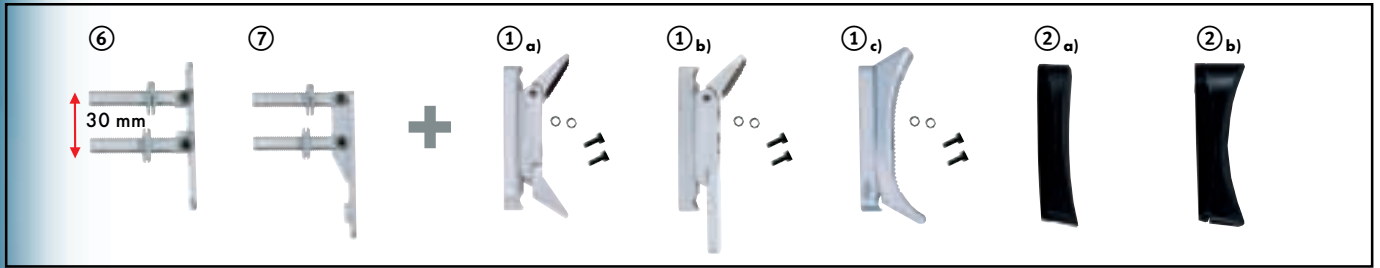

① a)
Alu-Schaftkappe 4759,
inklusive Befestigungselemente, speziell
für ANSCHÜTZ-Gewehre.
Alu butt plate 4759, incl. screws,
especially for ANSCHÜTZ rifles.
Best.-Nr.: 700.3590

① b)
Alu-Schaftkappe Auflage 4759A,
inklusive Befestigungselemente, speziell
für ANSCHÜTZ-Gewehre.
Alu butt plate Benchrest 4759A,
incl. screws, especially for ANSCHÜTZ rifles.
Best.-Nr.: 700.3594

① c)
Alu-Schaftkappe 4758,
inklusive Befestigungselemente, speziell
für ANSCHÜTZ-Gewehre.
Alu butt plate 4758, incl. screws,
especially for ANSCHÜTZ rifles.
Best.-Nr.: 700.3592

② a)
Gummikappe 4709 A,
gerade, inkl. Führungsplatte
und Befestigungsschrauben M5 x 30.
Rubber butt plate 4709 A,
straight, with guide plate
and set screws M5 x 30.
Best.-Nr.: 710.3702

② b)
Gummikappe 4709 B,
gewölbt, inkl. Führungsplatte
und Befestigungsschrauben M5 x 30.
Rubber butt plate 4709 B,
convex, with guide plate and set
screws M5 x 30.
Best.-Nr.: 710.3712

③
Biathlon-Schaftkappe
Biathlon butt plate
Best.-Nr.: 700.3350

④
Hakenkappe 4765-U4,
komplett mit Haken 4765-U3.
Hook butt plate 4765-U4,
complete with hook 4765-U3
Best.-Nr.: 700.3582

⑤
Hakenkappe 2213-8700,
komplett mit Führungsplatte 2213-8510.
Hook butt plate 2213-8700,
complete with guide plate 2213-8510.
Best.-Nr.: 700.3569

⑥
Kappenausleger 4759-2000, 30 mm
mit schwenkbarer Säulenführung.
Butt plate carrier 4759-2000, 30 mm,
with tilting column guide.
Best.-Nr.: 700.3564

⑦
Kappenausleger 9003/8002,
mit schwenkbarer Säulenführung.
Butt plate carrier 9003/8002,
with tilting column guide.
Best.-Nr.: 700.3573

⑧
Kappenausleger 2213-8300,
mit schwenkbarer Säulenführung.
Butt plate carrier 2213-8300,
with tilting column guide.
Best.-Nr.: 700.3563

⑨
Führungsplatte 2213-8510,
Guide plate 2213-8510,
Best.-Nr.: 700.3568

⑩
Führungssäule 4759-4000,
mit Befestigungselementen.
Guide column 4759-4000,
with fixing elements.
Best.-Nr.: 700.3566

⑪
Zwischenplatte 2213-8510-01-00-3
zur Montage der Führungssäule 4759-4000
auf Ausleger 2213-8300.
Spacer 2213-8510-01-00-3
to connect guide column 4759-4000
to hook plate carrier 2213-8300.
Best.-Nr.: 002011



↑ Schnellklemmung, für neue Verstellung.
Fast clamp device, for new adjustment.
Best.-Nr.: 700.3780 ①
Best.-Nr.: 700.3785 ②

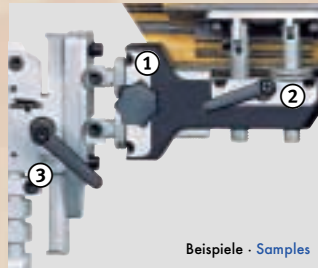

↑ Schnellklemmung, für Hakenkappe 4765
Fast clamp device, for hook butt plate 4765.
Best.-Nr.: 700.3790 ③



↑ Vorderschaftstütze 4770.
Bipod 4770.
Best.-Nr.: 700.3440



↑ Handstopp Biathlon 4738-U2, mit Schiessriemenbefestigung.
Hand stop Biathlon 4738-U2, with device for target sling.
Best.-Nr.: 700.3220



↑ Handstopp 4751, mit Riemenbügel.
Hand stop 4751, with sling swivel.
Best.-Nr.: 700.3600



↑ Handstopp 4752, mit Riemenbügel.
Hand stop 4752, with sling swivel.
Best.-Nr.: 700.3601



↑ Handstopp 6225 mit Riemenbügel, Ø 28 mm.
Hand stop 6225 with sling swivel, Ø 28 mm.
Best.-Nr.: 710.3610



↑ Handstopp 6226 mit Riemenbügel, Ø 32 mm.
Hand stop 6226, with sling swivel Ø 32 mm.
Best.-Nr.: 710.3600



← Adapter 4980, nur zur Montage des 19er Systems Links in den Wechselschaft 2313 Links.
Adapters 4980, only to connect barreled action of series 1900, left, to stock 2313 left.
Best.-Nr.: 700.3650



← Pistolengriff für LP@:
Pistol grip for LP@:
XS: Best.-Nr.: 705.8004
S: Best.-Nr.: 705.8001
M: Best.-Nr.: 705.8002
L: Best.-Nr.: 705.8003
M: Best.-Nr.: 705.8102 links/left.

Pistolengriffe:

Nach den ISSF-Regeln. Griffverstellung in jede Richtung dreh-, schwenk- und verschiebbar. Lieferung mit Befestigungsschraube.

Pistol grips:

Manufactured according to the ISSF rules. The grip adjustment can be turned, tilted and pushed in any direction. Delivered with screw.

Für LG Mod. 2002 und KK-Aluschaften:
For air rifle Mod. 2002 and small bore alu stocks:



① Schichtholz, natur/blau
Laminated wood, natural/blue
L: Best.-Nr.: 705.7826
M: Best.-Nr.: 705.7821

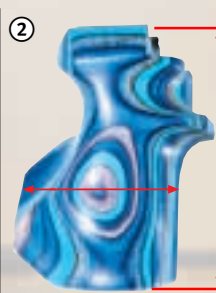

② Schichtholz, blau
Laminated, wood blue
L: Best.-Nr.: 705.7825*
M: Best.-Nr.: 705.7820*
L: Best.-Nr.: 705.7835 links/left.
M: Best.-Nr.: 705.7830 links/left.



Für LG Mod. 9003/8002:
For air rifle Mod. 9003/8002:



③ PRO-Grip, schwarz
PRO-Grip, black
L: Best.-Nr.: 705.7900
M: Best.-Nr.: 705.7905

L = Large:	Höhe/height: 120 mm / 4.72"
	Breite/width: 49 mm / 1.93"
M = Medium:	Höhe/height: 120 mm / 4.72"
	Breite/width: 51,5 mm / 2.03"

Antiallergischer Kunststoff.
Non allergic plastic.

④ 9003/8002 PRO-Grip, schwarz
9003/8002 PRO-Grip, black
L: Best.-Nr.: 705.7906
M: Best.-Nr.: 705.7907
L: Best.-Nr.: 705.7908 links/left.

* Nur solange Vorrat reicht - As long as available.

ANSCHÜTZ Zubehör-Programm

ANSCHÜTZ Accessories

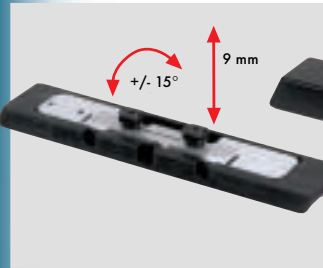

↑
Vorderschafterhöhung 4860,
PRO-Grip, 20 mm hoch, 248 mm lang.
Fore-end raiser block 4860,
PRO-Grip, 20 mm high, 248 mm long.
Best.-Nr.: 700.3631 Schwarz/black.

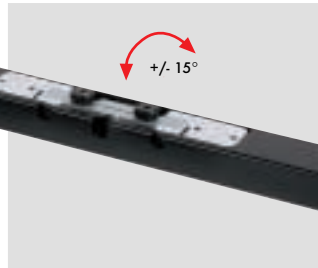

↑
Vorderschafterhöhung 4861,
Auflage, 28 mm hoch, 349 mm lang.
Fore-end raiser block 4861,
Benchrest, 28 mm high, 349 mm long.
Best.-Nr.: 700.3632 Schwarz/black.



↑
Vorderschafterhöhung 4852/1,
schwarz, Höhe 38 mm.
Fore-end raiser block 4852/1,
black, 38 mm high.
Best.-Nr.: 700.3621 Schwarz/black.



↑
Vorderschafterhöhung 4856,
Höhe 32 mm, mit Profilschiene.
Fore-end raiser block 4856,
32 mm high, with rail.
Best.-Nr.: 700.3622

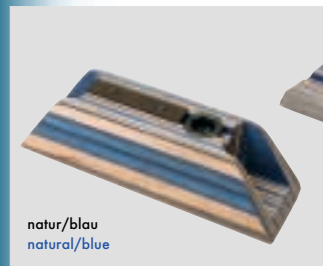

↑
Vorderschafterhöhung 2213-8500,
47 mm hoch, 170 mm lang, natur/blau.
Fore-end raiser block 2213-8500,
47 mm high, 170 mm long, natural/blue.
Best.-Nr.: 700.3633
Best.-Nr.: 700.3623 blau/blue.
Best.-Nr.: 700.3629 schwarz/black.

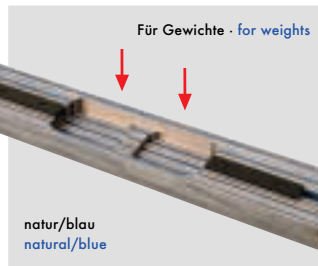

↑
Vorderschafterhöhung 2213-8550,
24 mm hoch, 315 mm lang, natur/blau.
Fore-end raiser block 2213-8550,
24 mm high, 315 mm long, natural/blue.
Best.-Nr.: 700.3634
Best.-Nr.: 700.3624 blau/blue.
Best.-Nr.: 700.3625 schwarz/black.



↑
Auflagekeil 1009, Buche schwarz,
für Aluschaft 2002.
Wedge 1009, Hardwood black,
for aluminum stock 2002.
Best.-Nr.: 705.0254*

Auflagekeil 1009 S, Schichtholz
blau, für Aluschaft 2002.
(ohne Abbildung).
Wedge 1009 S, laminated wood,
blue, for aluminum stock 2002.
(without picture).
Best.-Nr.: 705.0255*

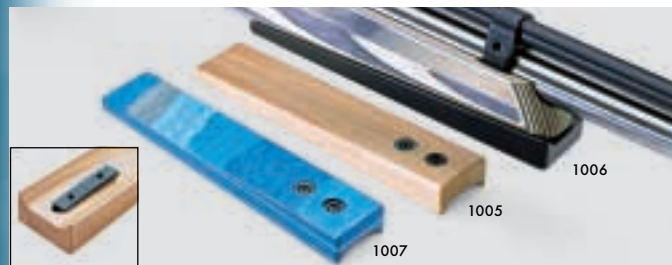

↑
Auflagekeil 1005, Buche.
Wedge 1005, Hardwood.
Best.-Nr.: 705.0250*

Auflagekeil 1006, Buche schwarz.
Wedge 1006, Hardwood black.
Best.-Nr.: 705.0251*

↑
Auflagekeil 1007, Schichtholz blau.
Wedge 1007, laminated wood, blue.
Best.-Nr.: 705.0254*



↑
**Vorderschafterhöhung Auflage
1022**, für Aluschaft 2213 und 2313,
25 mm hoch, 395 mm lang, Buche
schwarz.

**Fore-end raiser block benchrest
1022**, for aluminum stock 2213 and
2313, 25 mm high, 395 mm long,
Hardwood black.
Best.-Nr.: 705.0256



PRO-Grip INFO:
Der Grip kann je nach Bedarf vom Schützen mit
einfachem, feinem Schmirgelpapier geglättet und
somit dem individuellen Empfinden des Schützen
angepasst werden (siehe Abbildung).

PRO-Grip INFO:
The shooter can smoothen the grip with a fine,
abrasive paper and thus adapt it to his wishes
(see picture).

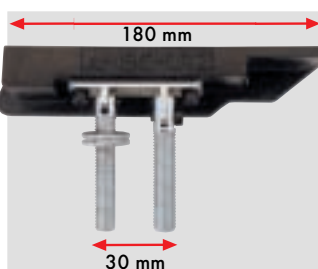

↑
**Alu Backenausleger inkl. Backe
9003 PRO-Grip**, schwarz.
**Alu cheek piece adjustment
complete with cheek piece
9003 PRO-Grip**, black.
Best.-Nr.: 700.3576

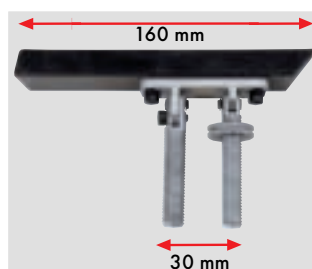

↑
**Alu Backenausleger inkl. Backe
8002 PRO-Grip**, schwarz.
**Alu cheek piece adjustment
complete with cheek piece
8002 PRO-Grip**, black.
Best.-Nr.: 700.3577

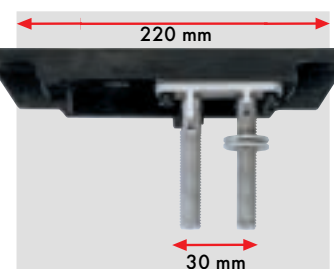

↑
**Alu Backenausleger inkl. Backe,
AUFLAGE, PRO-Grip**, schwarz.
**Alu cheek piece adjustment
complete with cheek piece
BENCHREST PRO-Grip**, black.
Best.-Nr.: 700.3578

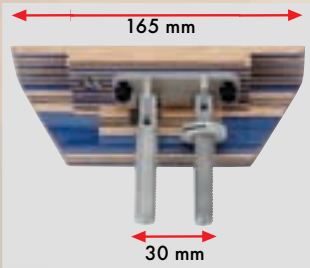

↑
Alu Backenausleger inkl. Backe, natur/blau.
Alu cheek piece adjustment complete with cheek piece, natural/blue.
Best.-Nr.: 700.3574



↑
Schaftbackenauflege 4818, selbstklebend.
Cheek piece cover 4818, adhesive.
Best.-Nr.: 710.3760

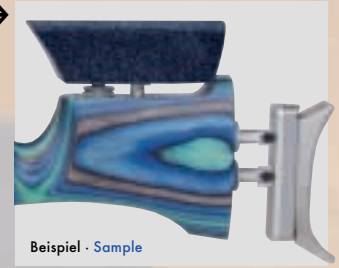

↑
Gummikappe 4709 B-U1, gewölbt.
Rubber butt plate 4709 B-U1, convex.
Best.-Nr.: 710.3710



↑
Gummikappe 4709 A-U1, gerade.
Rubber butt plate 4709 A-U1, straight.
Best.-Nr.: 710.3700



↑
Gummikappe 4709 B, gewölbt, inkl. Führungsplatte 4709 A-U2/1 und Befestigungsschrauben.
Rubber butt plate 4709 B, convex, with guide plate 4709 A-U2/1 and set screws.
Best.-Nr.: 710.3712



↑
Gummikappe 4709 A, gerade, inkl. Führungsplatte 4709 A-U2/1 und Befestigungsschrauben.
Rubber butt plate 4709 A, straight, with guide plate 4709 A-U2/1 and set screws.
Best.-Nr.: 710.3702



↑
Führungsplatte 4709 A-U2/1, komplett für Gummikappe.
Carrier 4709 A-U2/1, complete for rubber butt plate.
Best.-Nr.: 710.3715

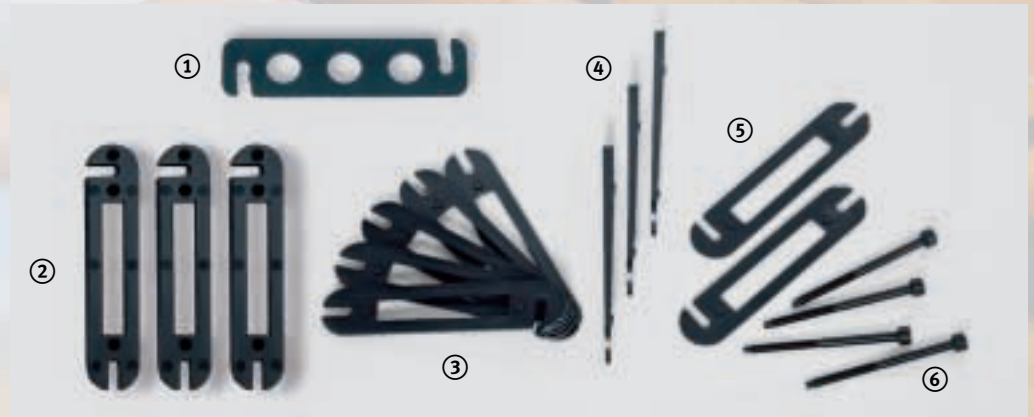

①
Zwischenplatte 380-225, parallel 2 mm.
Spacer 380-225, parallel 2 mm.
Best.-Nr.: 002429*

④
Zwischenplatte 380-270, keilförmig.
Spacer 380-270, wedge-shaped.
Best.-Nr.: 002432*

②
Zwischenplatte 400-230, Längskeil.
Horizontal angle spacer 400-230.
Best.-Nr.: 710.3755

⑤
Zwischenplatte 400-234, Querkeil.
Vertical angle spacer 400-234.
Best.-Nr.: 710.3757

③
Zwischenplatte 400-232, parallel 3 mm.
Spacer 400-232, parallel 3 mm.
Best.-Nr.: 710.3756

⑥
Schrauben JGA-N40 M5 x 72.
Screws JGA-N40 M5 x 72.
Best.-Nr.: 005139



↑
Zwischenplatte 4709 P, parallel 8 mm.
Spacer 4709 P, parallel 8 mm.
Best.-Nr.: 710.3750

ANSCHÜTZ Zubehör-Programm

ANSCHÜTZ Accessories



Für Pressluftgewehr
for compressed air rifle

↑
Adapter 430-U45, mit Luftfilter und Druckluftablassschraube für Nachfüllflasche.
Adapter 430-U45, with air filter and air release screw, for refill bottle.
Best.-Nr.: 711.3409



Für Pressluftgewehr
for compressed air rifle

↑
Nachfülladapter mit Feuchtigkeitsfilter/Trockenmittel. Speziell entwickelt für Nachfüllbehälter oder -vorrichtungen, die keine 100% ige Feuchtigkeitsabscheidung gewährleisten. Das austauschbare Trockenmittel trägt mit zur Funktionsfähigkeit Ihres Pressluftsystems bei, auch unter schwierigsten Voraussetzungen. Durch das DIN Gewinde ist der Adapter für alle Fabrikate verwendbar.

Refill adapter, with humidity filter/dry pellets. Especially developed for refill bottles or devices which do not guarantee an 100 % collection of humidity. The exchangeable dry pellets contribute to maintain the functionality of the compressed air device, even under the most difficult conditions.

Best.-Nr.: 711.3411 *



↑
Trockenmittelflasche, 250 g
Bottle of dry pellets, 250 g
Best.-Nr.: 700.6940 *



Für Pressluftgewehr
for compressed air rifle

↑
Entlüftungsbuchse, zum Entleeren der Pressluft-Kartusche.
Air release screw, for compressed air cylinder.
Best.-Nr.: 711.3408



Max. 200 bar / 2900 psi

↑
Pressluft-Kartusche für Luftgewehr, Aluminium mit Manometer, 43 cm lang, Gewicht: 430 g.
Compressed air cylinder for compressed air rifle, aluminum with manometer, 43 cm long, weight approx.: 430 g.
Best.-Nr.: 711.3418 Blau/blue.
Best.-Nr.: 711.3415 Silber/silver.
Best.-Nr.: 711.3414 Rot/red.
Best.-Nr.: 711.3413 Schwarz/black.
JUNIOR, 29 cm, 300 g.
Best.-Nr.: 711.3412 Silber/silver.



Max. 200 bar / 2900 psi

↑
Pressluft-Kartusche für LP-@ ANSCHÜTZ Luftpistole. Aluminium mit Manometer, 19 cm lang, Gewicht: 185 g.
Compressed air cylinder for LP-@ ANSCHÜTZ compressed air rifle, aluminum with manometer, 19 cm long, weight approx.: 185 g.
Best.-Nr.: 711.3471 Silber/silver.
Best.-Nr.: 711.3472 * Rot/red.
JUNIOR, 15 cm, 155 g.
Best.-Nr.: 711.3481 Silber/silver.
Best.-Nr.: 711.3482 * Rot/red.



Für Pressluftpistole
for compressed air pistol

↑
Nachfülladapter für LP-@ ANSCHÜTZ Luftpistole.
Refill adapter for LP-@ ANSCHÜTZ compressed air rifle.
Best.-Nr.: 711.3511

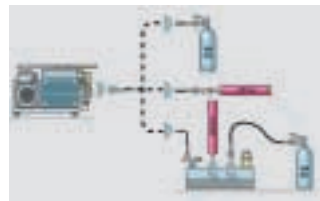

Filterpartonen und Wartungssätze auf Anfrage.
Filter cartridges and maintenance sets on demand.



↑
5 l Pressluft-Nachfüllflasche mit EWG Prüfung.
5 l Compressed air refill bottle with EWG approval.
Best.-Nr.: 711.3510



← **BAUER Hochdruckkompressor mit Kondenswasserabscheider**. Qualitativ sehr hochwertiger Kompressor, mit Filtersystem, für Druckluftnachfüllflaschen. Technik gem. DIN, VDE, TÜV und UV Vorschriften.

BAUER high pressure compressor with condensed water collector: Very high quality compressor with air filter system, to fill your refill bottle. Technology according to German DIN, VDE, TÜV and UV regulations.

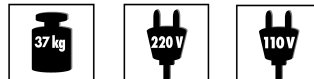

Kompressor, 200 bar, für 220 V/230 V, 50 Hz, 1,1 kW Leistung, Luftdurchsatz ca. 30 l/min.
Compressor, 200 bar, for 220 V/230 V, 50 Hz, 1,1 kW Air thrupt approx. 30 l/min.
Best.-Nr.: 711.3570

Kompressor, 200 bar, für 110 V, 60 Hz, 1,1 kW Leistung, Luftdurchsatz ca. 30 l/min.
Compressor, 200 bar, for 110 V, 60 Hz, 1,1 kW Air thrupt approx. 30 l/min.
Best.-Nr.: 711.3580



← **4-Stufen Hochdruckkompressor mit Kondenswasserabscheider. Das Kraftpaket zur Füllung Ihrer Druckluftnachfüllflasche:** Wahlweise mit Verbrennungsmotor oder für 220/230 V. Beliebte bei Vereinen und Profischützen.

4-step high pressure compressor with condensed water collector: Pure power to fill your refill bottle. Either with combustion engine or for 220/230V. Preferred by clubs and top class shooters.



Kompressor, 200 bar, für 220 V/230 V, 2,2 kW Leistung, Luftdurchsatz ca. 80 l/min.
Compressor, 200 bar, for 220 V/230 V, 2,2 kW Air thrupt approx. 80 l/min.
Best.-Nr.: 711.3550 *

Kompressor, 200 bar, 4,4 kW Leistung, Luftdurchsatz ca. 110 l/min. mit 4-Takt Verbrennungsmotor.
Compressor, 200 bar, 4,4 kW Air thrupt approx. 110 l/min. with 4-stroke combustion engine.
Best.-Nr.: 711.3560 *



↑
Magazin 525-U8, 10 Schuss,
.22 long rifle, für Halb-Automat.
Magazine 525-U 8, 10-shot,
.22 long rifle, for semi-automatic rifle.
Best.-Nr.: 700.4110



↑
Magazin 525-U10, 2 Schuss,
.22 long rifle, für Halb-Automat.
Magazine 525-U10, 2-shot,
.22 long rifle, for semi-automatic rifle.
Best.-Nr.: 700.4111



↑
Magazin 1420-U5, 5 Schuss,
.22 long rifle und .17 Mach 2.
Magazine 1420-U5, 5-shot,
.22 long rifle and .17 Mach 2.
Best.-Nr.: 700.4005



↑
Magazin 1420-U13, 10 Schuss,
.22 long rifle und .17 Mach 2.
Magazine 1420-U13, 10-shot,
.22 long rifle and .17 Mach 2.
Best.-Nr.: 700.4010



↑
Magazin 54.18 MS R-U2 Lochsch.
5 Schuss, für 1808, 64 R Schaft und
1827 Fortner mit gekürztem Magazin-
schacht, .22 long rifle.
Magazine 54.18 MS R-U2 thumbh.
5-shot, for 1808, 64 R stock and
1827 Fortner with shortened maga-
zine pit, .22 long rifle.
Best.-Nr.: 700.4260



↑
Magazin 1515-U3, 4 Schuss,
.22 Win. Magnum und .17 HMR.
Magazine 1515-U3, 4-shot,
.22 Win. Magnum and .17 HMR.
Best.-Nr.: 700.4304



↑
Magazin 1430-U4, 5 Schuss,
.22 Hornet.
Magazine 1430-U4, 5-shot,
.22 Hornet.
Best.-Nr.: 700.4405



↑
Magazin 1530-U4, 3 Schuss,
.222 Remington.
Magazine 1530-U4, 3-shot,
.222 Remington.
Best.-Nr.: 700.4503*



↑
Magazin 1827-U22/1, 5 Schuss,
.22 long rifle, für Biathlon.
Magazine 1827-U22/1, 5-shot,
.22 long rifle, for biathlon.
Best.-Nr.: 700.4250



↑
Einzelladeradapter 4846.
für Repetierer im Kaliber .22 long rifle.
Single shot adapter 4846,
for repeaters caliber .22 long rifle.
Best.-Nr.: 710.4700



↑
Magazin 275-U14, 12 Schuss,
4,4 mm Bleirundkugel Nr. 9.
Magazine 275-U14, 12-shot,
4,4 mm round lead pellet No. 9.
Best.-Nr.: 700.4612



↑
Magazin 2027-U5, 5 Schuss,
für Sommerbiathlon Pressluftgewehr
Modell 2027.
Magazine 2027-U5, 5-shot,
for summer biathlon compressed air
model 2027.
Best.-Nr.: 700.4200*



↑
Reservepatronenbox
1827F-45, für 6 Patronen.
Extra cartridge spender
1827F-45, for 6 cartridges.
Best.-Nr.: 710.3022



↑
Magazinhalter 1927-U23.
Magazine holder 1927-U23.
Best.-Nr.: 700.3320



↑
Abzugsschuh 5080-U1.
Trigger shoe 5080-U1.
Best.-Nr.: 700.6200*



↑
Abzugszüngel, vielseitig ver-
stellbar.
Trigger blade, adjustable.
Best.-Nr.: 700.6201

ANSCHÜTZ Zubehör-Programm

ANSCHÜTZ Accessories



50 g

↑
Laufgewicht 4745, 50 g, 2-teilig,
Innen-Ø 20 mm.
Two part barrel weight 4745,
50 g, inner Ø 20 mm.
Best.-Nr.: 700.6340*



50 g

↑
Laufgewicht 400-56C,
50 g, Innen-Ø 20 mm.
Barrel weight 400-56C,
50 g, inner Ø 20 mm.
Best.-Nr.: 700.6350*

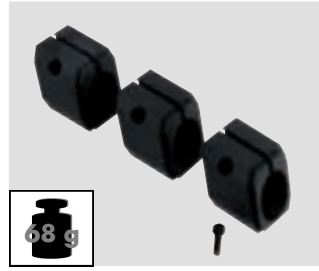

68 g

↑
Laufgewicht 4750,
68 g, Innen-Ø 20 mm.
Barrel weight 4750,
68 g, inner Ø 20 mm.
Best.-Nr.: 700.6341

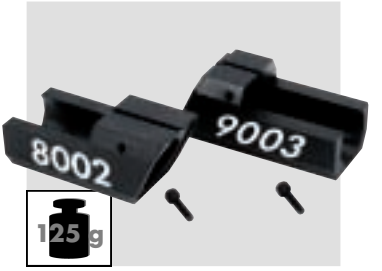

125 g

↑
Laufgewicht gross 8002/9003,
125 g, Innen-Ø 20 mm.
Barrel weight big 8002/9003,
125 g, inner Ø 20 mm.
Best.-Nr.: 700.6345 8002
Best.-Nr.: 700.6344 9003



75 g

↑
Gewichtsstein 2013-U82,
75 g, für 2013-U80, 2213, 2313,
inkl. Schraube und Sicherung.
Weight 2013-U82, 75 g
for 2013-U80, 2213, 2313,
incl. screw and special washer.
Best.-Nr.: 711.3011

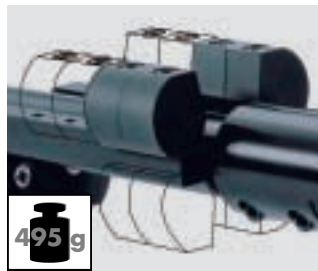

495 g

↑
Schaftzusatzgewicht 2013-U80,
Gesamtgewicht 495 g, inklusive 4
Gewichtssteine 2013-U82 (à 75 g).
Additional weight 2013-U80,
495 g, with 4 weights 2013-U82
(75 g each).
Best.-Nr.: 711.3000*

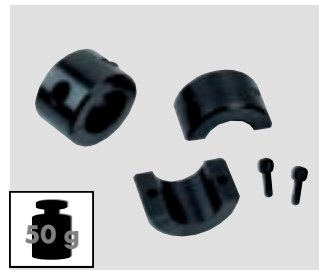

50 g

↑
Laufgewicht Biathlon, 2-teilig,
Innen-Ø 18 mm, 50 g,
Barrel weight Biathlon,
two part, inner Ø 18 mm, 50 g.
Best.-Nr.: 700.6135*

↑
Laufgewicht Biathlon Sprint,
2-teilig, Innen-Ø 16 mm, 50 g,
Barrel weight Biathlon Sprint,
two part, inner Ø 16 mm, 50 g.
Best.-Nr.: 700.6136*



100 g

↑
Laufgewicht Biathlon 1827F-4750, 2-teilig,
Innen-Ø 16-18 mm, 100 g,
Barrel weight Biathlon 1827F-4750, two part,
inner Ø 16-18 mm, 100 g.
Best.-Nr.: 710.3023



150 g

↑
Zusatzgewicht 4756,
für 2002 Aluschaft, ca. 150 g.
Weight 4756, approx. 150 g,
for 2002 aluminum stocks.
Best.-Nr.: 700.6339*

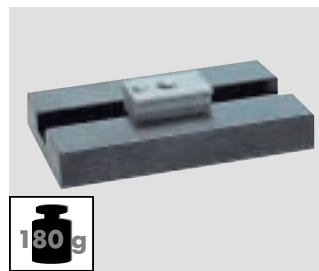
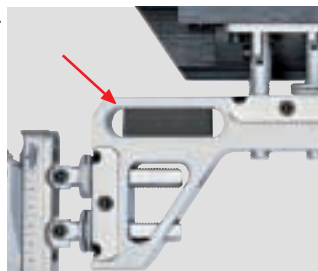

180 g

↑
Zusatzschiebegewicht,
für Aluminiumprofilschiene, ca. 180 g.
Sliding weight,
approx. 180 g, for aluminum rail.
Best.-Nr.: 700.6343



25 g

↑
Gewichtsring 4742, 25 g,
Innen-Ø 12 mm.
Weight 4742, 25 g, inner Ø 12 mm.
Best.-Nr.: 711.3805



100 g

↑
Gewichtsträger, für 9003/8002
Kappenausleger und Schaftbacken,
ca. 100 g.
Weight carrier, for 9003/8002
hook plate carrier and cheek piece,
approx. 100 g.
Best.-Nr.: 007557



100 g

↑
Gegengewichtsträger, für LP@ ANSCHÜTZ,
ohne Gewichtsringe, ca. 100 g, komplett mit Aufnahme.
Counter weight carrier, for LP@ ANSCHÜTZ,
without weights, approx. 100 g.
Best.-Nr.: 711.3800



Beispiel • Sample
Gegengewichtsträger für LP@
Counter weight carrier for LP@
Best.-Nr.: 711.3800
Gewichtsringe 4742 · Weights 4742
Best.-Nr.: 711.3805

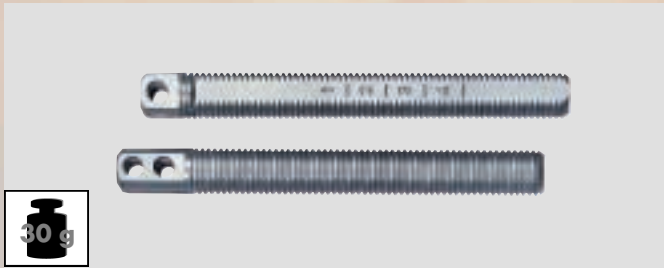

↑
Lange Alu-Säulen, ca. 30 g,
für Backenverstellung, 111 mm lang.
Long aluminum columns, approx. 30 g,
for cheek piece adjustment, 111 mm long.
Best.-Nr.: 700.6333

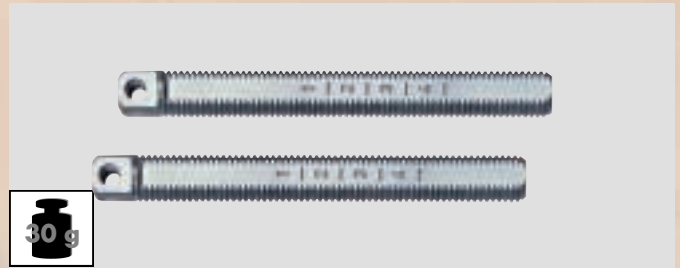

↑
Lange Alu-Säulen, ca. 30 g,
für Kappenverstellung, 111 mm lang.
Long aluminum columns, approx. 30 g,
for butt plate adjustment, 111 mm long.
Best.-Nr.: 700.6334



↑
Schwere Stahlsäulen, ca. 100 g,
für Backenverstellung, 71 mm lang.
Heavy steel columns,
approx. 100 g, for cheek piece
adjustment, 71 mm long.
Best.-Nr.: 700.6337



↑
Schwere Stahlsäulen, ca. 100 g,
für Kappenverstellung, 71 mm lang.
Heavy steel columns,
approx. 100 g, for butt plate adjust-
ment, 71 mm long.
Best.-Nr.: 700.6338

Alle Säulen haben ein
1/2 Zoll Gewinde.
All columns have
a 1/2" thread.



← **Beispiel · Samples**

Gewichtsträger · Weight carrier
Best.-Nr.: 007557
Gewichtsringe 4742 · Weights 4742
Best.-Nr.: 711.3805
Füllstück gross · Filling piece large
Best.-Nr.: 003687
Schraube für Füllstück · Screw for filling
piece
Best.-Nr.: 007807



↑
Füllstück klein,
für Hakenkappe 2213-8700,
ca. 7 g, 28 mm lang,
innen-Ø 11,9 mm. Ohne Schraube.
Filling piece small,
for hook butt plate 2213-8700,
approx. 7 g, 28 mm long,
inner Ø 11,9 mm. Without screw.
Best.-Nr.: 003685



↑
Füllstück mittel,
für Hakenkappe 2213-8700,
ca. 7,3 g, 30,5 mm lang,
innen-Ø 11,9 mm. Ohne Schraube.
Filling piece medium,
for hook butt plate 2213-8700,
approx. 7,3 g, 30,5 mm long,
inner Ø 11,9 mm. Without screw.
Best.-Nr.: 003686



↑
Füllstück gross,
für Hakenkappe 2213-8700,
ca. 10 g, 39 mm lang,
innen-Ø 11,9 mm. Ohne Schraube.
Filling piece large,
for hook butt plate 2213-8700,
approx. 10 g, 39 mm long,
inner Ø 11,9 mm. Without screw.
Best.-Nr.: 003687

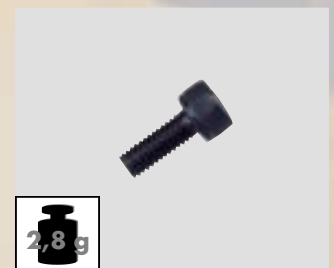

↑
Schraube für Füllstück,
M5 x 10 DIN 912, ca. 2,8 g.
Screw for filling piece,
M5 x 10 DIN 912, approx. 2,8 g.
Best.-Nr.: 007807

ANSCHÜTZ Zubehör-Programm

ANSCHÜTZ Accessories



↑
Spezialfett 4425.
Special grease 4425.
Best.-Nr.: 710.6310



↑
Reinigungs-Set 507.
Cleaning-Kit 507.
Best.-Nr.: 710.6325



↑
Reinigungsdochte 508.
Cotton wicks 508.
Best.-Nr.: 710.6326

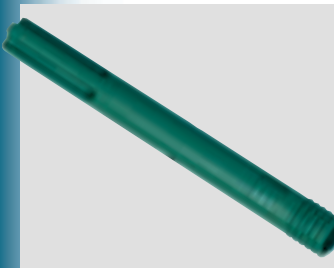

↑
Putzstockführung 4401, für KK-Matchgewehre und Zimmerstutzen.
Cleaning rod guide 4401, for match small bore barrels.
Best.-Nr.: 710.6340



↑
Drehmomentschrauber 4405, Schlüsselweite 4 (SW4).
Torque wrench 4405, (SW4).
Best.-Nr.: 700.6180

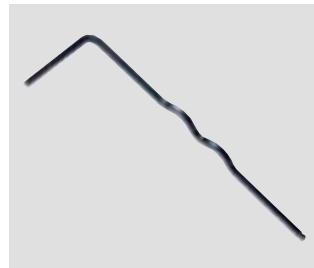

↑
Innensechskantschlüssel 4406, SW 4 (wellenförmig).
Allan key 4406, SW 4.
Best.-Nr.: 710.6301



↑
Reinigungsset, mit 4-teiligem Putzstock, für LG, KK und Zimmerstutzen.
Cleaning-Kit, with cleaning rod, for air rifle, small bore and "Zimmerstutzen".
Best.-Nr.: 710.6332

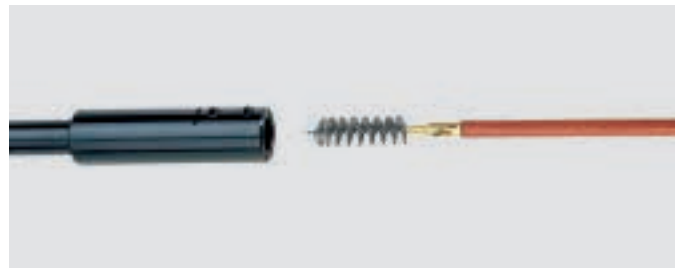

↑
Reinigungsgerät 4422/1, für Mündungsrohr der Modelle 2007/2013
Cleaning-Kit 4422/1, for muzzle tube by models 2007/2013.
Best.-Nr.: 710.6350



↑
Ersatzteilset KLEIN, für 9003/8002.
Spare part kit SMALL, for 9003/8002.
Best.-Nr.: 700.6981



↑
Alu-Set für Systemlagerung 9003, nur zur Montage des 9003 Systems in den Aluminiumschaft 9003.
Aluminum kit for barreled action bedding 9003, only to connect barreled action of series 9003 with stock 9003.
Best.-Nr.: 700.9504

Für Modelle · for models
1907, 1913, 2007, 2013.



↑
Schlagbolzen 1807-12,
inkl. Feder und Federstütze.
Firing pin 1807-12,
incl. spring and spring support.
Best.-Nr.: 700.6906
ohne Feder und Federstütze.
without spring and spring support.
Best.-Nr.: 700.6905

Ohne Abbildung.
Without picture.

Für Modelle · for models
1907, 1913, 2007, 2013.



↑
Trainings Schlagbolzen 1807T-12,
inkl. Feder und Federstütze.
Firing pin for training 1807T-12,
incl. spring and spring support.
Best.-Nr.: 700.6901
ohne Feder und Federstütze.
without spring and spring support.
Best.-Nr.: 700.6900

Ohne Abbildung.
Without picture.



↑
Schlagbolzen
Fortner Biathlon 1827F-6.
Firing pin
Fortner Biathlon 1827F-6.
Best.-Nr.: 700.6910



↑
Montagehilfe 4729
für Schlagbolzen Fortner Biathlon.
Mounting tool 4729
for firing pin Fortner Biathlon.
Best.-Nr.: 710.6300



↑
Trockentrainingsadapter
Fortner Biathlon 1827F-40.
Adapter for dry firing
Fortner Biathlon 1827F-40.
Best.-Nr.: 710.3050



↑
Stabilisator, für 8002.
Stabilizer, for 8002.
Best.-Nr.: 700.6342



↑
Ersatzteilset für das ANSCHÜTZ
Matchprogramm.
Spare part kit for the ANSCHÜTZ
match program.
Best.-Nr.: 700.6970



↑
Ersatzteilset GROSS,
für 9003/8002.
Spare part kit BIG,
for 9003/8002.
Best.-Nr.: 700.6980

ANSCHÜTZ Zubehör-Programm

ANSCHÜTZ Accessories



↑ **Gewehrkoffer 201,**
für 1 Gewehr (122 x 25 x 11 cm).
Gun case 201,
for 1 rifle (122 x 25 x 11 cm).
Best.-Nr.: 711.8000



↑ **Gewehrkoffer 202,**
für 2 Gewehre (133 x 32 x 11 cm).
Gun case 202,
for 2 rifles (133 x 32 x 11 cm).
Best.-Nr.: 711.8001



↑ **Gewehrkoffer 203,**
extra breit für 2 Gewehre und Zubehör (133 x 37 x 11 cm).
Gun case 203,
extra wide for 2 rifles and accessories (133 x 37 x 11 cm).
Best.-Nr.: 711.8002*



↑ **Flintenkoffer 233,**
für 1 Kippaufwaffe (96 x 32 x 11 cm).
Gun case 233,
for 1 break-down gun (96 x 32 x 11 cm).
Best.-Nr.: 711.8003*



↑ **Gewehrkoffer 285,**
wasserdicht, für 2 Langwaffen mit Zubehör (137 x 39 x 15 cm).
Gun case 285,
waterproof, for 2 rifles and accessories (137 x 39 x 15 cm).
Best.-Nr.: 711.8005



↑ **Gewehrkoffer 253,**
für 2 Matchgewehre (121 x 39 x 13 cm).
Gun case 253,
for 2 target rifles (121 x 39 x 13 cm).
Best.-Nr.: 711.8004



← **Pistolenkoffer,**
für LP-@ ANSCHÜTZ (46,5 x 24 x 9 cm).
Pistol case,
for LP-@ ANSCHÜTZ (46,5 x 24 x 9 cm).
Best.-Nr.: 711.3598

Sporttasche BIG, lieferbar in zwei Ausführungen:

Die zweiteilige Sporttasche lässt sich von der Mitte mittels Reißverschluss aufklappen und gewährleistet Ihnen im geöffneten Zustand sehr übersichtlich Einblick auf Ihr Zubehör. Im einteiligen, grossen, abschliessbaren Fach können Sie Schiessjacke und Schiesshose unter minimalster Faltenbildung einlegen. Das schont Ihre Bekleidung und hält sie länger stabil. Im dreiteiligen Fach können Sie Ihr weiteres wertvolles Zubehör wie Schiessschuhe, Handschuhe, Brille etc. übersichtlich einordnen. Kein lästiges und zeitraubendes Suchen mehr. Die Rollen und der ausziehbare Bügel ermöglichen leichtes, kraftsparendes Transportieren der Sporttasche. Der starke Kunststoffboden verhindert eine Verformung und schützt Ihre Ausrüstung. Weitere Utensilien können in den seitlich oder im Oberteil angebrachten Einschubtaschen verstaut werden. (80 x 40 x 34 cm).

Sports Bag BIG, available in two versions:

The sport bag is opened up in the middle. One side can be locked by zipper, here you may store your jacket and trousers lengthwise, both will thus last longer! The other side is divided in three compartments, each one can be locked by zipper. You will see that it is no longer necessary to rummage your bag for the things you are looking for. Small compartments on one side of the bag may be used for targets, portfolios etc. The bag has rolls and an extensible frame grip for easy pulling. (80 x 40 x 34 cm).

① Best.-Nr.: 711.8105

② Best.-Nr.: 711.8106



Futtermal PICK-UP:

In Zusammenarbeit mit Spitzenschützen, hat die Firma ANSCHÜTZ das Futtermal "PICK-UP" entwickelt.

Sicher und schonend kann das Sportgewehr und das empfindliche Zubehör untergebracht und transportiert werden. Als besondere Ausstattung ermöglicht ein zusätzliches Trageriemensystem, das Futtermal auch auf dem Rücken zu tragen. Ebenfalls können Sie das Futtermal als Montageunterlage nutzen, um das Gewehr beim Zusammenbau zu schützen. Innenfutter aus antistatischem Material verhindert das Verschmutzen der Gewehre.



- Fixierriemen mit Klettverschluss sichern das Gewehr im Futtermal.
- Passformgerechter Zuschnitt am Futtermal verhindert das Verrutschen des Gewehrs.
- Sortimentschlaufen für das Unterbringen von Werkzeug und Zubehör.
- Integrierte Kartuschenhalterung für Ersatzkartusche.
- Tragegriff.
- Trageriemensystem ermöglicht das bequeme Tragen auf dem Rücken.
- Schlaufe ermöglicht das Aufhängen an einem Haken.

- Inner lining of anti-static material to avoid dirt on the rifles.
- Fixing belts with velcro closure hold the rifle in a safe position.
- The cut follows the shape of the rifle to avoid any slipping in the soft case.
- Extra departments to store tools and accessories.
- Integrated holder for a spare compressed air cylinder.
- Carrying handle.
- Carrying belt system to carry the soft case on the back.
- Hanger to hang it on a hook.

Best.-Nr.: 710.6306

Soft case PICK UP:

In permanent contact and cooperation with top-class shooters ANSCHÜTZ has developed the soft case „PICK-UP“.

For safe transportation of the target rifle as well as the sensitive accessories. It is also possible to carry the soft case on the back due to a special belt system. In addition you can use the soft case as a pad on which you can assemble your rifle.



ANSCHÜTZ Rucksack

Ein modischer Rucksack, der Ihnen beim Transport von Equipment nützliche Dienste leisten wird. Seitlich besitzt der Rucksack 2 Netzgitter, in denen man eine Trinkflasche fixieren kann. Eine aufgesetzte Vordertasche bietet Platz für Schreibblock und andere Dinge.



ANSCHÜTZ Back Pack

A fashionable back pack for the transportation of all your equipment. On the side it has 2 elastic meshes for holding your bottles. A pocket on the front has room for your writing materials.

Best.-Nr.: 711.8200

Best.-Nr.: 711.8201



ANSCHÜTZ Zubehör-Programm

ANSCHÜTZ Accessories

Biathlon Futteral 9912, für 1827 → ANSCHÜTZ Fortner Biathlon.

- Bequemes tragen auf dem Rücken mit dem Tragegestell des innenliegenden Biathlongewehres.
- Herausnehmbare Plane als Wetzschutz zum Umhüllen des Futterals und als Arbeitsunterlage.
- Sortimenttaschen für das Unterbringen von Werkzeug und Zubehör.
- Sichtfenster.
- Zwei Tragegriffe.
- Neuartiges Reissverschluss-System.



Biathlon soft case 9912, für 1827 ANSCHÜTZ Fortner Biathlon.

- Easy to carry on the back with harness of biathlon rifle inside.
- Unfoldable cover as weather protection and foil to lay down the rifle.
- Compartments for tools and accessories.
- Transparent window.
- Two handles.
- New zipper system.

Best.-Nr.: 710.6307



↑

CONQUEST Allwetterjacke mit austrennbarer und wendbarer Innenjacke und im Kragen integrierter Kapuze.

Nylon/Taffeta, 100% Polyamid, PU-beschichtet, atmungsaktiv. 100% wasserdicht, Nähte verschweisst. Futter: Antipilling Polarfleece, 100% Polyester.

CONQUEST All Weather Jacket with removable, reversible sleeved body warmer, nylon hood in collar.

Nylon/Taffeta, 100% polyamide, PU coated, breathable. 100% waterproof, welded seams. Non-melting fleece lining, 100% polyester.

Best.-Nr.: 680.6003* = S

Best.-Nr.: 680.6004* = M

Best.-Nr.: 680.6005* = L

Best.-Nr.: 680.6006* = XL

Best.-Nr.: 680.6007* = XXL



↑

ANSCHÜTZ Cap 7910, passend für alle Kopfgrößen – stufenlos verstellbar durch Klettverschluss. Material: 60 % Baumwolle, 40 % Polyester.

ANSCHÜTZ Cap 7910, fits all head sizes. Variably adjustable by velcro closure. Material: 60 % cotton, 40 % polyester. **Best.-Nr.: 711.6450**



↑

Schiessmütze bunt 7950, (blau / weiss), 60% Baumwolle, 40% Polyester.

Shooting cap color 7950, (blue/ white), 60% cotton, 40% polyester.

Best.-Nr.: 711.6410*



↑

ANSCHÜTZ Augenblende, weiss, 30 x 100 mm, 100% PVC.

ANSCHÜTZ Eye shield, white, 30 x 100 mm 100% PVC.

Best.-Nr.: 009077



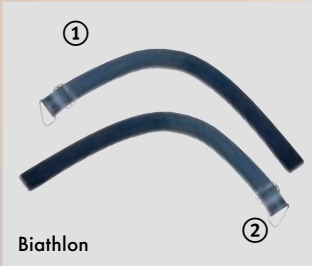

Biathlon

①
Armschlaufe 4737/2-U3, rechts.
Arm sling 4737/2-U3, right.
Best.-Nr.: 700.3130

②
Armschlaufe 4737L-U3, links.
Arm sling 4737L-U3, left.
Best.-Nr.: 700.3131



Biathlon

↑
Schiessriemen 4738, mit Handstopp und Armschlaufe, rechts.
Target sling 4738, with hand stop and arm sling, right.
Best.-Nr.: 700.3120

↑
Schiessriemen 4738L, mit Handstopp und Armschlaufe, links.
Target sling 4738L, with hand stop and arm sling, left.
Best.-Nr.: 700.3121



Biathlon

↑
Schiessriemen 4738-U1, rechts, ohne Handstopp, ohne Armschlaufe.
Target sling 4738-U1, right, without hand stop and arm sling.
Best.-Nr.: 710.3020

↑
Schiessriemen 4738L-U1, links, ohne Handstopp, ohne Armschlaufe.
Target sling 4738L-U1, left, without hand stop and arm sling.
Best.-Nr.: 710.3021



Biathlon

↑
Tragegestell 1927-U16.
Harness 1927-U16.
Best.-Nr.: 700.3300

↑
Tragegestell 1827-9000 mit elastischen Bändern.
Harness 1827-9000 with elastic straps.
Best.-Nr.: 700.3301



Biathlon

↑
Armschlaufe 4735, für Rechts- und Linksschützen.
Arm sling 4735, for right- and left hand shooters.
Best.-Nr.: 700.3132



Biathlon

↑
Schiessriemen 4736-U2, rechts mit Handstopp 6226, für Armschlaufe 4735 oder 4737/2-U3.
Target sling 4736-U2, right with hand stop 6226, for arm sling 4735 or 4737/2-U3.
Best.-Nr.: 710.3026

↑
Schiessriemen 4736L-U2, links mit Handstopp 6226, für Armschlaufe 4735 oder 4737L-U3.
Target sling 4736-U2, right with hand stop 6226, for arm sling 4735 or 4737L-U3.
Best.-Nr.: 710.3028



Ohne Handstopp
Without hand stop

Biathlon

↑
Schiessriemen 4736, rechts für Handstopp 4738-U2 und Armschlaufe 4735 oder 4737/2-U3.
Target sling 4736, right for hand stop 4738-U2 and arm sling 4735 or 4737/2-U3.
Best.-Nr.: 710.3025

↑
Schiessriemen 4736L, links für Handstopp 4738-U2 und Armschlaufe 4735 oder 4737L-U3.
Target sling 4736, left for hand stop 4738-U2 and arm sling 4735 or 4737L-U3.
Best.-Nr.: 710.3027



Biathlon

↑
Handstopp Biathlon 4738-U2, mit Schiessriemenbefestigung.
Hand stop Biathlon 4738-U2, with device for target sling.
Best.-Nr.: 700.3220



↑
Schiessriemen 7400 S, Synthetik, schwarz.
Target sling 7400 S, synthetic, black.
Best.-Nr.: 710.3017



↑
150 Jahre ANSCHÜTZ Metall-Pin mit Butterfly-Verschluss, 35 x 13 mm.
150 years ANSCHÜTZ metal pin with butterfly lock, 35 x 13 mm.
Best.-Nr.: 711.6471 *



↑
ANSCHÜTZ Aufkleber ca. 85 x 55 mm.
ANSCHÜTZ Sticker approx. 85 x 55 mm.
Best.-Nr.: 799.3010



↑
ANSCHÜTZ Aufnäher ca. 85 x 55 mm, 100% Polyester.
ANSCHÜTZ Sticker (to sew on) approx. 85 x 55 mm, 100% polyester.
Best.-Nr.: 799.3005



↑
150 Jahre ANSCHÜTZ Weichgummi Aufnäher in 3 D Prägetechnik 90 x 32 mm.
150 years ANSCHÜTZ soft rubber sticker, 3D, 90 x 32 mm.
Best.-Nr.: 711.6461 *



↑
150 Jahre ANSCHÜTZ Metallschild ohne Bohrungen (zum Kleben, z.B. mit Spiegelklebeband) 90 x 32 mm.
150 years ANSCHÜTZ metal plate without drills (to adhere, e. g. with adhesive tape for mirrors) 90 x 32 mm.
Best.-Nr.: 711.6467 *

ANSCHÜTZ Zubehör-Programm

ANSCHÜTZ Accessories



↑ **ANSCHÜTZ Jagdkatalog.**
ANSCHÜTZ Hunting Rifles.
Best.-Nr.: 799.0002 Deutsch/German
Best.-Nr.: 799.0020 English/English



↑ **ANSCHÜTZ Tischfahne**
Wimpel mit Holzständer.
ANSCHÜTZ table flag
Pennant with wood rack.
Best.-Nr.: 799.3000



↑ **ANSCHÜTZ Prospektständer.**
ANSCHÜTZ leaflet holder.
Best.-Nr.: 799.0000



↑ **ANSCHÜTZ Plakatständer,**
Aluminium, wetterbeständig.
ANSCHÜTZ poster rack,
aluminum, weatherproof.
Best.-Nr.: 799.0100



↑ **Das ANSCHÜTZ Buch**
Büchsenmacher seit Jahrhunderten.
The ANSCHÜTZ Book
Only available in German.
Best.-Nr.: 799.1511



↑ **ANSCHÜTZ Plastiktragetasche.**
ANSCHÜTZ plastic bag.
Best.-Nr.: 799.2000



↑ **ANSCHÜTZ Krug.**
ANSCHÜTZ stein.
Best.-Nr.: 799.1500 Gross - large
Best.-Nr.: 799.1510 Klein - small



↑ **ANSCHÜTZ Kugelschreiber.**
ANSCHÜTZ Pen.
Best.-Nr.: 799.3100



↑ **ANSCHÜTZ Aufkleber 1913**
ca. 58 x 160 mm.
ANSCHÜTZ Sticker 1913
approx. 58 x 160 mm.
Best.-Nr.: 799.3015



↑ **ANSCHÜTZ Aufkleber 9003**
ca. 58 x 160 mm.
ANSCHÜTZ Sticker 9003
approx. 58 x 160 mm.
Best.-Nr.: 799.3016



← **ANSCHÜTZ Aufkleber Biathlon**
ca. 100 x 100 mm.
ANSCHÜTZ Sticker Biathlon
approx. 100 x 100 mm.
Best.-Nr.: 799.3013

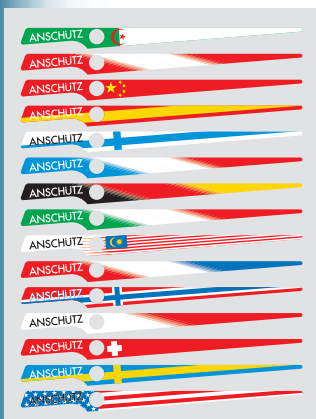

← **9003 Systemträger Aufkleber „FLAG“.**
9003 stock design sticker "FLAG".
Best.-Nr.: 799.3044 ALG
Best.-Nr.: 799.3036 AUT
Best.-Nr.: 799.3041 CHN
Best.-Nr.: 799.3031 ESP
Best.-Nr.: 799.3043 FIN
Best.-Nr.: 799.3039 FRA
Best.-Nr.: 799.3042 GER
Best.-Nr.: 799.3038 ITA
Best.-Nr.: 799.3040 MAS
Best.-Nr.: 799.3035 NED
Best.-Nr.: 799.3037 NOR
Best.-Nr.: 799.3032 POL
Best.-Nr.: 799.3033 SUI
Best.-Nr.: 799.3034 SWE
Best.-Nr.: 799.3030 USA
Weitere Länder auf Anfrage - further countries on demand

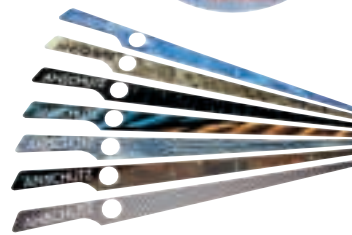

↑ **9003 Systemträger Aufkleber-Set „TECHNIK“.**
9003 stock design sticker kit "TECHNIC".
Best.-Nr.: 799.3017



↑ **9003 Systemträger Aufkleber-Set.**
9003 stock design sticker kit.
Best.-Nr.: 799.3018



← **Poster Schnittmodell 8002**
Vorder- und Rückseite bedruckt, DIN A1.
Poster View 8002
Printed on the front and back page DIN A1.
Best.-Nr.: 799.0053



↑ **Poster Dioptr**
Vorder- und Rückseite bedruckt, DIN A1.
Poster sight
Printed on the front and back page DIN A1.
Best.-Nr.: 799.0052



↑ **Poster Gewitter der Leidenschaft**
Vorder- und Rückseite bedruckt, DIN A1.
Poster Thunderstorm of Passion
Printed on the front and back page DIN A1.
Best.-Nr.: 799.0054

Wir bedanken uns bei allen
Sportschützen, Trainern und
Betreuern, die sich durch ihre
Anregungen und konstruktive
Kritik an der Entwicklung un-
serer ANSCHÜTZ-Produkte und
somit auch an der Zusammen-
stellung dieses Kataloges beteiligt
haben.

We thank all target shooters and
trainers who participated in the
development of our ANSCHÜTZ
products with their ideas and
suggestions and who thus contri-
buted to the composition of this
catalogue.

Info-Seiten
Info Pages

So finden Sie uns ...

How you find us ...



DIE MEISTER MACHER

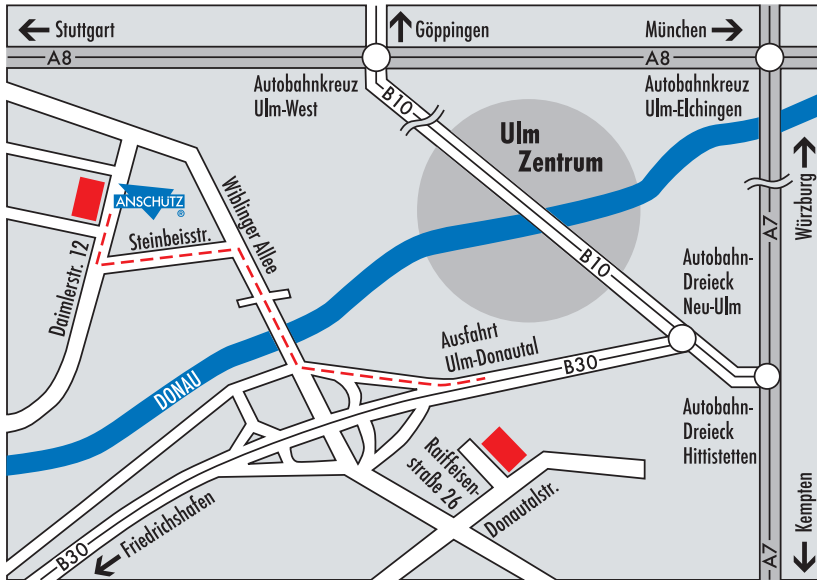

- Autobahn A 8 / Stuttgart – München Autobahn **Ausfahrt Ulm-West**.
 - Folgen Sie den blauen Autobahn-Schildern in Richtung **Friedrichshafen/Biberach**.
 - Weiter auf der B10 und anschliessend auf der B30 bis zur **Ausfahrt Industriegebiet Ulm-Donautal** (weisses Schild).
 - Sie fahren nun auf der Wiblinger Allee, nach ca. 500 m dann die **zweite** Strasse nach links (weisses Schild **Donautal Nord**).
 - Dann weiter bis zum Ende der Strasse. Dort biegen Sie dann **rechts** in die Daimlerstrasse ein.
 - Nach ca. 200 m Entfernung sehen Sie links das ANSCHÜTZ-Gebäude. Vor dem Haus gibt es Kunden-Parkplätze.
- On the Motorway A 8 / Stuttgart – München take the exit **Ulm-West**.
 - Follow the blue signs pointing to **Friedrichshafen/Biberach**.
 - Continue until you get to the exit **Industriegebiet Ulm-Donautal** (white sign).
 - You are now on the road "Wiblinger Allee", take the **second** turn to the left after approx. 500 m (white sign **Donautal Nord**).
 - Follow the road to the end and turn **right** into Daimlerstrasse.
 - After about 200 meters you'll see the ANSCHÜTZ building on the left. There is a parking lot in front of the building.

More Information

www.anschuetz-sport.com

<http://www.anschuetz-sport.com>
E-mail: JGA-Info@anschuetz-sport.com
immer auf dem neuesten Stand

<http://www.anschuetz-sport.com>
E-mail: JGA-Info@anschuetz-sport.com
ANSCHÜTZ up-to-date information

Erfolge · Results

www.anschuetz-sport.com

Ständig neue Umfragen und Gewinnaktionen im Internet.
Hier erhalten Sie erste Informationen über unsere Produkte und Neuheiten. Ausserdem bieten wir einen umfangreichen Download-Service, angefangen bei unseren Katalogen über Ersatzteillisten und Bedienungsanleitungen bis hin zu unserer Film- und Bildergalerie. Nutzen Sie unseren reichhaltigen Informationsdienst.

Surveys and chances to win prizes on our website.
You will get here detailed information on our models and new products. In addition we offer you an extensive download service starting from our catalogues, spare part lists and manuals up to our photo- and film gallery. Take advantage of our comprehensive information service.

Filme · Movies

www.anschuetz-sport.com

ANSCHÜTZ News LETTER

Kennen Sie schon den kostenlosen **ANSCHÜTZ Newsletter**?
Einfach abonnieren unter
www.anschuetz-sport.com

Do you already know the free of charge **ANSCHÜTZ Newsletter**?
Simply subscribe to it at
www.anschuetz-sport.com



Das ANSCHÜTZ „Info-Formular“ für Ihr ganz spezielles Sportgerät:

Optimieren Sie Ihr Sportgerät! Wir nennen Ihnen Upgrade-Möglichkeiten, wie Sie mit ANSCHÜTZ Zubehör noch bessere Ergebnisse erzielen können. Wir sagen Ihnen gerne wie und beraten Sie ausführlich. Schicken Sie uns das ausgefüllte Blatt mit Ihren Angaben und Fragen einfach zu. Antwort kommt postwendend.

The ANSCHÜTZ “Info-Form” for your very special target gun:

Optimize your target gun! We will give you upgrade possibilities with which you can achieve even better results with the ANSCHÜTZ accessories. We would be pleased to tell you how this works. Please send us this form with your information and questions. We will answer by return of mail.

Bitte faxen/schicken Sie mir die speziell für mein Sportgerät ausgestellte Liste aller Möglichkeiten.

Please fax/mail a list with all possibilities for my personal target gun.

Hersteller · *Manufacturer*

Modell · *Model*

Serien-Nr. · *Serial No.*

Herstellungsjahr · *Year of manufacture*

Händler · *Dealer*

Mein Name · *Name*

Vorname(n) · *First Name*

Strasse/Nr. · *Street/No.*

PLZ/Ort · *Zip Code/City*

Land · *Country*

Verein · *Club*

Telefon · *Telephone*

Telefax · *Fax*

E-mail

Meine Frage an ANSCHÜTZ · *My question to ANSCHÜTZ*

Bisher verwendetes Zubehör · *Accessories used up to now*

Datum / Unterschrift · *Date/ Signature*

Hiermit bestelle ich für € 5,- Schutzgebühr in Briefmarken den ANSCHÜTZ-

Match-Katalog

Jagd-Katalog

an obenstehende Adresse.

Please send me for € 5,- fee your ANSCHÜTZ-

Target Catalogue

Hunting Catalogue

to the address at the top.



Ihre Zufriedenheit liegt uns am Herzen

Your satisfaction is our motivation



DIE MEISTER MACHER

* Ihre Zufriedenheit liegt uns sehr am Herzen!

Bitte teilen Sie uns Ihre Wünsche mit und was nach Ihrer Meinung an den ANSCHÜTZ-Produkten verbessert oder verändert werden sollte und gewinnen Sie einen von vielen attraktiven Sachpreisen, die wir am Ende eines jeden Kalenderjahres unter den eingesandten Kommentaren verlosen.

ANSCHÜTZ ist zufrieden, wenn Sie es sind! Nach diesem Grundsatz entwickeln und fertigen wir unsere Qualitätsprodukte. Der enge Kontakt zu unseren Kunden auf der ganzen Welt hat unsere Produkte zu dem gemacht, was sie sind: Ein Garant für hervorragende Verarbeitung und erstklassige Qualität. Damit dies auch in Zukunft so bleibt, liegt uns viel an der kontinuierlichen Verbesserung unseres Produktprogramms und der Umsetzung Ihrer Wünsche. Ihre Mithilfe ist dabei nach wie vor von grosser Bedeutung. Lassen Sie uns wissen, was Sie sich an unseren Produkten wünschen oder was Ihrer Meinung nach verändert werden muss. Ihre Anregungen von heute sind Ausgangspunkt für unsere Entwicklungen von morgen und damit der Meilenstein für Ihren Schiessersfolg.

Bitte lassen Sie uns mit diesem Formular Ihre Kommentare zukommen. Wir bedanken uns für Ihre Hilfe und freuen uns auf Ihre Anregungen.

* Your satisfaction is our motivation!

Please let us know your ideas or what you think should be changed or improved with regard to the ANSCHÜTZ products and win one of many attractive prizes which we will raffle at the end of each calendar year among the commentaries we will have received.

ANSCHÜTZ is satisfied when you are satisfied! This philosophy is the basis for the development of our high quality products. The close contact to our customers all over the world has made our products what they are: A synonym for extraordinary workmanship and first-class quality. In order to keep this high standard we are very much engaged in continuously improving our product range and complying with your requirements. Your help is of utmost importance in this process. Please let us know what you expect from our products or what you think should be changed. Your commentaries of today are the basis for our developments of the future and therefore a milestone for your shooting success.

Please let us have your ideas with this page. We thank you for your help and are looking forward to your commentaries.

**MEINUNG SAGEN
UND GEWINNEN ***

Name · **Name**

Strasse/Nr. · **Street/No.**

PLZ/Ort · **Zip Code/City**

Fon/Fax

Land · **Country**

E-mail





Hinweis:

Produktspezifikationen, Konstruktions- und Modelländerungen sind ohne vorhergehende Ankündigung vorbehalten. Alle Mass- und Farbangaben sind freibleibend. Druckfehler, Irrtum und Zwischenverkauf ebenfalls vorbehalten.

Lieferung ausschliesslich über den Fachhandel, gegen Altersnachweis bzw. Erwerbsberechtigung.

ANSCHÜTZ, das ANSCHÜTZ-Logo und das ANSCHÜTZ-Logo in Verbindung mit dem Schriftzug „Die Meister Macher“ (auch in abgeänderter Schreibweise) sind markenrechtlich geschützte Zeichen der J.G. ANSCHÜTZ GmbH & Co. KG, Ulm, Germany. Die Benutzung dieser Zeichen ist ohne Zustimmung der Firma J.G. ANSCHÜTZ GmbH & Co. KG unzulässig und strafbar.

Dieser Katalog ist ein Schriftwerk im Sinne des § 2 (1), Nr. 1 des Urheberrechtsgesetzes. Die Verwertung des Katalogs, auch auszugsweise ist ohne Zustimmung der Firma J.G. ANSCHÜTZ GmbH & Co. KG unzulässig und strafbar. Insbesondere gilt dies für Vervielfältigungen, Übersetzungen und die Einspeicherung in elektronische Systeme.

Note:

Product specifications, design and model changes are subject to change without prior notice. Dimensions and colors are subject to change. With reservation of misprints and errors. Goods are subject to prior sale.

Delivery subject to the presentation of the referring license for the purchase of firearms.

ANSCHÜTZ, the ANSCHÜTZ logo and the ANSCHÜTZ logo in connection with the slogan "Die Meister Macher" (also in modified spelling) are protected brands of J.G. ANSCHÜTZ GmbH & Co. KG, Ulm, Germany. The unauthorized use of this brand name is not allowed and punishable.

All rights of this catalogue reserved. The use of the catalogue, also in excerpts, is not allowed without the permission of J. G. ANSCHÜTZ GmbH & Co. KG and otherwise is punishable. This is especially applicable for unauthorized copying, translations and read-ins into electronic systems.

ANSCHÜTZ Symbol-Beschreibung

ANSCHÜTZ Symbol Folding Page and Description



Schaftholz Bunt:

Anatomisch perfekter Buntschaft aus durchgefärbtem Schichtholz.



Schaftholz Nuss:

Anatomisch perfekter, lackierter, schön gewachsener Nussbaumschaft mit Punzierung.



Schaftholz Buche:

Anatomisch perfekter, lackierter Buchenschaft mit Punzierung.



Aluminium-Schaft:

Aus leichtem Spezialaluminium mit hervorragenden Einstellmöglichkeiten.



Schaftkappen- und Backenverstellung:

ANSCHÜTZ Aluminium-Schaftkappen- und Backenverstellung, die vielseitig, individuell und einfach zu verstellen ist. Die gewünschten Einstellungen für den optimalen Anschlag sind durch bedienungsfreundliche Verstellelemente gegeben und durch angebrachte Skalen schnell und leicht wieder reproduzierbar.



Gummischaftkappe:

Die vertikal verstellbare Gummischaftkappe, kombiniert mit den austauschbaren Zwischenplatten ermöglicht eine individuelle Längenverstellung des Schaftes. Die Gummikappe liegt angenehm, satt und fest in der Schulter und gibt somit optimalen Halt. Ein Verrutschen wird durch die spezielle Gummimischung mit aufgebrachtem Profil ausgeschlossen.



Aluminium-Schaftkappe 4759 und Aluminium-Schaftkappe 4758:

Die ANSCHÜTZ Aluminium Schaftkappen sind in allen für den Schützen wichtigen Achsen schnell verschiebbar und schwenkbar und ermöglichen dadurch die optimale Anpassung der Kappe an jeden Schützen. Die Kappe 4759 kann zusätzlich individuell an die Schulterweite des Schützen angepasst werden. Durch den Ausleger mit Säulenführung ist die Kappe stufenlos in der Länge verstellbar sowie schwenkbar. Dies ermöglicht die ideale Anpassung der Schaftlänge, gemäss den Vorschriften der ISSF. Skalen helfen, die gewünschten Einstellungen leicht zu finden. Der Anti-Rutschbelag bei Modell 4759 und die Riffelungen im Anlagebereich der Kappe verhindern ein Verrutschen der Kappe im Anschlag.



Hakenkappe 2213-8700:

Spezielle Entwicklung für die Freie Waffe und das Sportgewehr. Sie ist in den wichtigen Achsen schnell und sicher verstellbar. Diese Hakenkappe erfüllt somit alle Anforderungen, welche heute im Spitzensport gefordert werden. Durch den Ausleger mit exakter Säulenführung ist die Kappe stufenlos in der Länge verstellbar und ermöglicht so die individuelle Anpassung des Schaftes. Die Skalen helfen, die gewünschten Einstellungen leicht und exakt zu finden sowie schnell und präzise wieder zu reproduzieren. Die Riffelung im Anlagebereich der Kappe an der Schulter verhindert ein Verrutschen der Kappe im Anschlag. Die Füllstücke in unterschiedlicher Länge mit der drehbaren Schulterklappe ermöglichen zusätzlich eine optimale Anpassung im Schulter-/Achselbereich. Haken und Hakenende sind in Höhe und Seite einstellbar.



Durchgehende Aluminium-profilsciene am Schaft:

Für vielfältig verstellbares Zubehör, wie z.B. Handstopp mit Riemenbügel, Handstütze, Vorderschaftserhöhung oder Vorderschaftstütze.



ANSCHÜTZ Präzisions-Matchlauf:

Zylindrischer Präzisions-Matchlauf, mit ausgezeichneter Schussleistung, der in einem seit Jahrzehnten bewährten und immer wieder verbesserten ANSCHÜTZ-Spezialverfahren hergestellt wird.



ANSCHÜTZ schwerer Präzisions-Matchlauf:

Schwerer zylindrischer Präzisions-Matchlauf, mit ausgezeichneter Schussleistung, der in einem seit Jahrzehnten bewährten und immer wieder verbesserten ANSCHÜTZ-Spezialverfahren hergestellt wird.



Match 54 Verschluss:

Der aus dem weltberühmten ANSCHÜTZ Match 54 Verschluss mit exzentrisch gelagertem Schloss laufend weiterentwickelte Verschluss ist für seine überzeugende Präzision und nicht zu überbietende Zuverlässigkeit bekannt. Er sorgt durch seine solide Fertigung für eine ausgezeichnete Schussleistung.



Match 64 Verschluss:

Bewährtes ANSCHÜTZ Match 64 Zylinderverschlussystem mit Schiebesicherung überzeugt durch seine Robustheit und Qualität.



Match-Druckpunkttabzug:

Vielfach verstellbarer Match-Druckpunkttabzug mit Sicherung. Das Abzugszüngel ist längenverstellbar und um 15 Grad schwenkbar. Die vielfältigen Einstellmöglichkeiten, insbesondere der grosse Gewichtsbereich, gewährleisten die Verwendung des Abzuges für nahezu alle Disziplinen. Der Abzug ist wahlweise auf Druckpunkt oder Direkt einstellbar.



Match-Direktabzug:

Wie Match-Druckpunkttabzug 5018, 5020 und 5021, jedoch auf Direkt eingestellt. Das Abzugszüngel ist ebenfalls längenverstellbar und um 15 Grad schwenkbar.



Match-Druckpunkttabzug:

Vielfach verstellbarer Match-Druckpunkttabzug mit Sicherung. Das Abzugszüngel ist längenverstellbar. Die vielfältigen Einstellmöglichkeiten, insbesondere der grosse Gewichtsbereich, gewährleisten die Verwendung des Abzuges für nahezu alle Disziplinen. Der Abzug ist wahlweise auf Druckpunkt oder Direkt einstellbar.



Match-Direktabzug:

Wie Match-Druckpunkttabzug 5092, 5098 und 5101 jedoch auf Direkt eingestellt.



Match-Druckpunkttabzug:

Vielfach verstellbarer Match-Druckpunkttabzug für das Luftgewehrschiessen. Das Abzugsgewicht ist vom Werk aus auf ca. 100 g eingestellt. Der Einstellbereich liegt zwischen 30 g und 170 g. Das Abzugszüngel ist beim 5065 A vielseitig verstellbar, beim 5065 B längenverstellbar und um 15 Grad schwenkbar.



Sicherung:

Sichert Ihr Sportgerät vor unbeabsichtigtem Auslösen.



Signalstift:

Zur Anzeige, ob das Verschlussystem gespannt ist.



Colored stock:
Anatomically perfect colored stock of laminated colored wood.



Walnut stock:
Anatomically perfect lacquered walnut stock with stippled checkering.



Hardwood stock:
Anatomically perfect lacquered hardwood stock with stippled checkering.



Aluminum stock:
Made of light special aluminum with extraordinary adjusting possibilities.



Cheek piece and butt plate adjustment:
ANSCHÜTZ cheek piece and butt plate adjustment, simple, variable adjustments. Handy adjusting elements for optimum position. Scales allow a fast and easy reproduction of the adjustments.



Rubber butt plate:
The vertically adjustable rubber butt plate combined with the interchangeable spacers allow an individual adjustment of the length. The rubber butt plate fits the shoulder very well. No slip properties due to a special rubber composite and special pattern.



Aluminum butt plate 4759 and aluminum butt plate 4758:
The ANSCHÜTZ aluminum butt plates can be adjusted in all important axes and thus make an optimum adjustment to the shooter's shoulder possible. In addition the butt plate 4759 can be adapted to the shooter's shoulder size. The butt plate is variably adjustable in length by a carrier with column guide. It can also be tilted. This guarantees an optimum adjustment of the stock length according to the ISSF rules. With the scales it is no problem to find the desired adjustments easily. The anti-skid surface at the end of the butt plate avoids any skidding at the shoulder.



Hook butt plate 2213-8700:
This butt plate was especially developed for the disciplines of Free Rifle and Sport Rifle. It is a butt plate that can be adjusted quickly in all important axes and thus fulfills all requirements which are demanded in today's top class shooting. The butt plate is variably adjustable in length by a carrier with exact column guide and thus makes it possible to adjust the stock individually to every shooter. With the scales it is no problem to find the desired adjustments easily and to reproduce them quickly. The no slip surface at the end of the butt plate avoids any skidding at the shoulder. The filling pieces in various lengths and the butt plate that can be turned allow an additional optimum adjustment in shoulder and arm pit. The complete hook as well as the end of it can be adjusted horizontally and vertically.



Aluminum rail on the stock:
For accessories such as hand stop with sling swivel, palm rest, forend raiser block or forend support.



ANSCHÜTZ match barrel:
Cylindrical match barrel with extraordinary shooting performance manufactured by the renowned ANSCHÜTZ special process which has been improved again and again.



ANSCHÜTZ heavy match barrel:
Heavy cylindrical barrel with extraordinary shooting performance manufactured in the renowned ANSCHÜTZ special process which has been improved again and again.



Match 54 action:
This action was developed on the basis of the famous ANSCHÜTZ match 54 action with eccentric bolt and is renowned for its unsurpassed accuracy and reliability. Extraordinary shooting performance due to the careful manufacturing process.



Match 64 action:
The famous ANSCHÜTZ match 64 cylindrical action with sliding safety catch is robust and of high quality.



Match two stage trigger:
Adjustable match two stage trigger with safety. The trigger blade is adjustable in length and **can be tilted up to 15°**. The use in almost all disciplines is guaranteed by the various adjusting possibilities, especially the wide range of adjusting the weight. The trigger can be adjusted as two stage or single stage trigger.



Match single stage trigger:
Like the match two stage trigger 5018, 5020 and 5021 but adjusted as single stage trigger. The trigger blade is adjustable in length and **can be tilted up to 15°**.



Match two stage trigger:
Adjustable match two stage trigger with safety. The trigger blade is adjustable in length. The use in almost all disciplines is guaranteed by the various adjusting possibilities, especially the wide range of adjusting the weight. The trigger can be adjusted as two stage or single stage trigger.



Match single stage trigger:
The same as the match two stage trigger 5092, 5098 and 5101 but adjusted as a single stage trigger.



Match two stage trigger:
Multiply adjustable two stage trigger for air rifle shooting. The trigger weight is adjusted by the factory to approx. 100 g. The adjusting range is from 30 g to 170 g. The trigger blade of the model 5056 A is variably adjustable. The trigger blade of the model 5065 B is adjustable in length and can be turned at an angle of 15 degrees.



Safety:
Protects your target gun from inadvertent shot release.



Signal pin:
To indicate whether the action is cocked.

Modell Model	Bild-Nr. Picture No.	Best.-Nr. Item No.	Ausführung Version	Schaftart Stock	Holzfarbe Wood color	PRO-Grip Farbe PRO-Grip color	Griffgröße Grip size	Rechtsausführung Right hand version	Linksausführung Left hand version	Schaftkappe Butt plate	Abzug Trigger	Magazin [Schuss] Magazine [shot]	Einzellader Single loader	Kaliber Caliber	Lauflänge (cm) Barrel	Geschwindigkeit Velocity
1827 ANSCHÜTZ Fortner	1	205.2400		Nuss	natur	---	---	R	---	Biathlon	5020	5	---	.22 l.r.	55	55
1827 ANSCHÜTZ Fortner	2	205.2920	Sprint	Nuss	natur	---	---	R	---	Biathlon	5020	5	---	.22 l.r.	55	55
1827 ANSCHÜTZ Fortner	3	205.3920	Sprint	Nuss	natur	---	---	L	---	Biathlon	5020 L	5	---	.22 l.r.	55	55
64 R Biathlon	4	219.2003	Mehrlader Repeater	Buche	natur	---	---	R	---	4709 A	5103	5	---	.22 l.r.	54	54
64 R Biathlon	5	219.3002	Mehrlader Repeater	Buche	natur	---	---	R	---	4709 A	5103	5	---	.22 l.r.	54	54
64 R Biathlon	6	219.3102	Mehrlader Repeater	Buche	natur	---	---	L	---	4709 A	5103L	5	---	.22 l.r.	54	54
64 R Biathlon	7	219.3022	Mehrlader Repeater	Buche	natur	---	---	R	---	4709 A	5104	5	---	.22 l.r.	54	54
LaserPower Biathlon	8	716.0000		Buche	natur	---	---	R	L	4709 B	5067	---	---	Laser	---	---
LaserPower Biathlon	9	716.0004	JAGD HUNTING	Buche	natur	---	---	R	L	4709 B	5067	---	---	Laser	---	---
9003 Premium	10	560.4990		ALU schwarz	---	schwarz	L	R	---	4759	5065A	---	---	4,5 mm	64	42
9003 Premium	11	560.4995		ALU schwarz	---	schwarz	M	R	---	4759	5065A	---	---	4,5 mm	64	42
9003 Premium	12	560.4940	AUFLAGE BENCHREST	ALU schwarz	---	schwarz	L	R	---	4709 A	5065A	---	---	4,5 mm	64	42
9003 Premium	13	560.4941	AUFLAGE BENCHREST	ALU schwarz	---	schwarz	M	R	---	4709 A	5065A	---	---	4,5 mm	64	42
8002 Pressluft	14	560.2902	JUNIOR	Schichtholz	blau/orange	---	---	R	L	4758	5065A	---	---	4,5 mm	53	42
8002 Pressluft	15	560.2910	VEREIN CLUB	Nuss	natur	---	---	R	L	4758	5065A	---	---	4,5 mm	64	42
8002 Pressluft	16	560.2932		ALU silber	---	schwarz	L	R	---	4759	5065A	---	---	4,5 mm	64	42
8002 Pressluft	17	560.2933		ALU silber	---	schwarz	M	R	---	4759	5065A	---	---	4,5 mm	64	42
8002 Pressluft	18	560.2935		ALU schwarz	---	schwarz	L	R	---	4759	5065A	---	---	4,5 mm	64	42
8002 Pressluft	19	560.2936		ALU schwarz	---	schwarz	M	R	---	4759	5065A	---	---	4,5 mm	64	42
8002 Pressluft	20	560.3935		ALU schwarz	---	schwarz	L	---	L	4759	5065A	---	---	4,5 mm	64	42
8002 Pressluft	21	560.2937	LIGHT	ALU schwarz	---	schwarz	M	R	---	4759	5065A	---	---	4,5 mm	53	42
8002 Pressluft	22	560.2940	AUFLAGE BENCHREST	ALU schwarz	---	schwarz	L	R	---	4759 A	5065A	---	---	4,5 mm	64	42
8002 Pressluft	23	560.2941	AUFLAGE BENCHREST	ALU schwarz	---	schwarz	M	R	---	4759 A	5065A	---	---	4,5 mm	64	42
8002 Pressluft	24	560.2942	AUFLAGE BENCHREST	Nuss	natur	---	---	R	---	4759 A	5065A	---	---	4,5 mm	64	42
8002 Pressluft	25	560.3940	AUFLAGE BENCHREST	ALU schwarz	---	schwarz	L	---	L	4759 A	5065A	---	---	4,5 mm	64	42
8002 Pressluft	26	560.2955		Schichtholz	blau	---	---	R	---	4759	5065A	---	---	4,5 mm	64	42
275 Repetier-Luftgewehr	27	578.0000		Buche	dunkel	---	---	R	L	---	275-U10	12	---	4,4 mm	44	44
LP@ ANSCHÜTZ	28	670.0001		Nuss	---	---	S	R	---	---	---	---	---	4,5 mm	23,5	23,5
LP@ ANSCHÜTZ	29	670.0002		Nuss	---	---	M	R	---	---	---	---	---	4,5 mm	23,5	23,5
LP@ ANSCHÜTZ	30	670.0003		Nuss	---	---	L	R	---	---	---	---	---	4,5 mm	23,5	23,5
LP@ ANSCHÜTZ	31	670.0012		Nuss	---	---	M	---	L	---	---	---	---	4,5 mm	23,5	23,5
LP@ ANSCHÜTZ	32	670.0004	LIGHT	Nuss	---	---	XS	R	---	---	---	---	---	4,5 mm	16	16
1903 KK-Matchgewehr	33	210.0900		Nuss	natur	---	---	R	---	4709 A	5098	---	---	.22 l.r.	65	65
1903 KK-Matchgewehr	34	210.1900		Nuss	natur	---	---	L	---	4709 A	5098 L	---	---	.22 l.r.	65	65
1903 KK-Matchgewehr	35	210.4000	JUNIOR Target	Buche	natur	---	---	R	L	4709 A	5098	---	---	.22 l.r.	54	54
64 R Sporter Target	36	219.4500	JUNIOR Target	Buche	natur	---	---	R	L	4709 A	5098	5	---	.22 l.r.	54	54
1907 KK-Matchgewehr	37	201.0924		Nuss	dunkel	---	---	R	---	4759	5018	---	---	.22 l.r.	66	66
1907 KK-Matchgewehr	38	201.0926	VEREIN CLUB	Nuss	natur	---	---	R	L	4709 A	5018	---	---	.22 l.r.	66	66
1907 KK-Matchgewehr	39	201.0922		Nuss	dunkel	---	---	R	---	4709 A	5018	---	---	.22 l.r.	66	66
1907 KK-Matchgewehr	40	201.1924		Nuss	dunkel	---	---	L	---	4759	5018 L	---	---	.22 l.r.	66	66
1913 im Schaft 1907	41	202.0920		Nuss	dunkel	---	---	R	---	4759	5018	---	---	.22 l.r.	69	69
1907 im Schaft 1912	42	201.6920		Nuss	natur	---	---	R	---	2213-8700	5018	---	---	.22 l.r.	66	66
1907 im Schaft 2213	43	201.6875		ALU silber	natur-blau	---	M	R	---	2213-8700	5018	---	---	.22 l.r.	66	66
1907 im Schaft 2213	44	201.6885		ALU silber	blau	---	M	---	L	2213-8700	5018 L	---	---	.22 l.r.	66	66
2007/660 im Schaft 2313	45	200.6875		ALU silber	natur-blau	---	M	R	---	2213-8700	5018	---	---	.22 l.r.	66	66
2007/660 Nuss*	46	200.0820		Nuss	natur	---	---	R	---	4759	5018	---	---	.22 l.r.	66	66
1907 R KK-Matchgewehr	47	141.4900	Mehrlader Repeater	Schichtholz	blau	---	---	R	---	4759	5022	10	---	.22 l.r.	66	66
1907 R KK-Matchgewehr	48	141.4901	Mehrlader Repeater	ALU G&E RS III	blau	---	M	R	---	4759	5022	10	---	.22 l.r.	66	66
1913 "Super Match"	49	202.0970		Nuss	natur	---	---	R	---	2213-8700	5018	---	---	.22 l.r.	69	69
1913 im Schaft 2213	50	202.5875		ALU silber	natur-blau	---	L	R	---	2213-8700	5018	---	---	.22 l.r.	69	69
1913 im Schaft 2213	51	202.5876	AUFLAGE BENCHREST	ALU silber	natur-blau	---	L	R	---	4759 A	5018	---	---	.22 l.r.	69	69
1913 im Schaft 2213	52	202.5885		ALU silber	blau	---	L	---	L	2213-8700	5018 L	---	---	.22 l.r.	69	69
2013/690 im Schaft 2313	53	200.5875		ALU silber	natur-blau	---	L	R	---	2213-8700	5018	---	---	.22 l.r.	69	69

* Nur solange Vorrat reicht - As long as available.

Wartung (mm)	Geschossführung (cm) Barrel length (inch)	Gesamtlänge (cm) Rifling (inch)	Systemlänge (cm) Total length (inch)	Visierlänge (cm) Barreled action (inch)	Visierlänge (cm) Sighting line (inch)	Gewicht (kg) Weight approx. (lbs)	Hinweis Note
55	104	73	---	4,0	---	4,0	nitrierter Lauf
21.6	40.9	28.7	---	8.8	---	8.8	nitrided steel barrel
55	104	73	---	3,7	---	3,7	nitrierter Lauf
21.6	40.9	28.7	---	8.22	---	8.22	nitrided steel barrel
55	104	73	---	3,7	---	3,7	nitrierter Lauf
21.6	40.9	28.7	---	8.22	---	8.22	nitrided steel barrel
54	100	69	---	3,6	---	3,6	seitliche Schiene
21.2	39.3	27.2	---	7.9	---	7.9	aluminum rail
54	100	69	---	3,6	---	3,6	seitliche Schiene, verstellbare Backe
21.2	39.3	27.2	---	7.9	---	7.9	aluminum rail, adjustable cheek piece
54	100	69	---	3,6	---	3,6	seitliche Schiene, verstellbare Backe
21.2	39.3	27.2	---	7.9	---	7.9	aluminum rail, adjustable cheek piece
54	100	69	---	3,6	---	3,6	seitliche Schiene, verstellbare Backe
21.2	39.3	27.2	---	7.9	---	7.9	aluminum rail, adjustable cheek piece
---	95	66	---	2,0	---	2,0	Gewehr komplett mit Ziel und Beipack
---	37.4	25.98	---	4.44	---	4.44	rifle complete with target and spare parts
---	95	66	---	2,0	---	2,0	JAGD, Gewehr komplett mit Ziel und Beipack
---	37.4	25.98	---	4.44	---	4.44	HUNTING, complete with target and spare parts
42	108-111	78	---	4,4	---	4,4	silberne Kartusche
16.5	42.5-43.7	30.7	---	9.78	---	9.78	silver air cylinder
42	108-111	78	---	4,4	---	4,4	silberne Kartusche
16.5	42.5-43.7	30.7	---	9.78	---	9.78	silver air cylinder
42	108-111	78	---	4,4	---	4,4	silberne Kartusche
16.5	42.5-43.7	30.7	---	9.78	---	9.78	silver air cylinder
42	108-111	78	---	4,4	---	4,4	silberne Kartusche
16.5	42.5-43.7	30.7	---	9.78	---	9.78	silver air cylinder
42	95-98	67	---	3,7	---	3,7	inkl. Visierung 6834
16.5	37.4-38.58	26.38	---	8.22	---	8.22	incl. sight set 6834
42	107-110	78	---	3,8	---	3,8	inkl. Visierung 6834
16.5	42.13-43.31	30.7	---	8.38	---	8.38	incl. sight set 6834
42	107-110	78	---	4,6	---	4,6	blaue Kartusche
16.5	42.13-43.31	30.7	---	10.22	---	10.22	blue air cylinder
42	107-110	78	---	4,6	---	4,6	blaue Kartusche
16.5	42.13-43.31	30.7	---	10.22	---	10.22	blue air cylinder
42	107-110	78	---	4,6	---	4,6	rote Kartusche
16.5	42.13-43.31	30.7	---	10.22	---	10.22	red air cylinder
42	107-110	78	---	4,6	---	4,6	rote Kartusche
16.5	42.13-43.31	30.7	---	10.22	---	10.22	red air cylinder
42	107-110	78	---	4,6	---	4,6	rote Kartusche
16.5	42.13-43.31	30.7	---	10.22	---	10.22	red air cylinder
42	107-110	78	---	4,6	---	4,6	rote Kartusche
16.5	42.13-43.31	30.7	---	10.22	---	10.22	red air cylinder
42	105-108	78	---	4,5	---	4,5	rote Kartusche
16.5	41.34-42.52	30.7	---	10	---	10	red air cylinder
42	105-108	78	---	4,5	---	4,5	rote Kartusche
16.5	41.34-42.52	30.7	---	10	---	10	red air cylinder
42	105-108	78	---	4,1	---	4,1	silberne Kartusche, Spannhebel links montiert
16.5	41.34-42.52	30.7	---	9.04	---	9.04	silver air cylinder, cocking lever on the left side
42	105-108	78	---	4,5	---	4,5	rote Kartusche
16.5	41.34-42.52	30.7	---	10	---	10	red air cylinder
42	107-110	78	---	4,3	---	4,3	silberne Kartusche
16.5	42.13-43.31	30.7	---	9.46	---	9.46	silver air cylinder
44	105	73	---	2,8	---	2,8	---
17.3	41.3	28.7	---	6.22	---	6.22	---
23,5	42,5	---	34-40	1,02	---	1,02	mit 2 Kartuschen
9.25	16.54	---	13.39-15.75	2.27	---	2.27	with 2 air cylinders
23,5	42,5	---	34-40	1,02	---	1,02	mit 2 Kartuschen
9.25	16.54	---	13.39-15.75	2.27	---	2.27	with 2 air cylinders
23,5	42,5	---	34-40	1,02	---	1,02	mit 2 Kartuschen
9.25	16.54	---	13.39-15.75	2.27	---	2.27	with 2 air cylinders
23,5	42,5	---	34-40	1,02	---	1,02	mit 2 Kartuschen
9.25	16.54	---	13.39-15.75	2.27	---	2.27	with 2 air cylinders
16	36	---	29,5-33	0,84	---	0,84	mit 2 Kartuschen
6.30	14.17	---	11.8-12.99	1.87	---	1.87	with 2 air cylinders
65	109	79	---	4,4	---	4,4	---
25.59	42.91	31.1	---	9.8	---	9.8	---
65	109	79	---	4,4	---	4,4	---
25.59	42.91	31.1	---	9.8	---	9.8	---
54	98	69	---	3,5	---	3,5	---
21.26	38.58	27.17	---	7.8	---	7.8	---
54	98	69	---	3,6	---	3,6	mit Schiene
21.26	38.58	27.17	---	8	---	8	with rail
66	113-116	82	---	4,8	---	4,8	---
25.9	44.49-45.67	32.28	---	10.6	---	10.6	---
66	107	82	---	4,4	---	4,4	---
25.9	42.13	32.28	---	9.78	---	9.78	---
66	113-116	82	---	4,8	---	4,8	---
25.9	44.49-45.67	32.28	---	10.6	---	10.6	---
66	113-116	82	---	4,8	---	4,8	---
25.9	44.49-45.67	32.28	---	10.6	---	10.6	---
69	116-119	85	---	5,0	---	5,0	---
27.1	45.67-46.85	33.46	---	11.1	---	11.1	---
66	106-109	82	---	4,9	---	4,9	---
25.9	41.7-42.9	32.28	---	10.8	---	10.8	---
66	109-112	82	---	5,5	---	5,5	---
25.9	42.91-44.09	32.28	---	12.2	---	12.2	---
66	109-112	82	---	5,5	---	5,5	mit 4980 und Schaft 2313 L
25.9	42.91-44.09	32.28	---	12.2	---	12.2	with 4980 and stock 2313 L
66	109-112	82	---	5,5	---	5,5	---
25.9	42.91-44.09	32.28	---	12.2	---	12.2	---
66	109-112	5,0	---	5,0	---	5,0	---
25.9	42.91-44.09	11	---	11.1	---	11.1	---
66	113-116	82	---	4,8	---	4,8	---
25.9	44.49-45.66	32.28	---	10.6	---	10.6	---
66	113-116	82	---	4,8	---	4,8	G&E RS III Revolution Aluminiumschaft
25.9	44.49-45.66	32.28	---	10.6	---	10.6	G&E RS III Revolution aluminum stock
69	112-115	85	---	5,6	---	5,6	---
27.16	44.09-45.28	33.46	---	12.4	---	12.4	---
69	112-115	85	---	5,8	---	5,8	---
27.16	44.09-45.28	33.46	---	12.8	---	12.8	---
69	112-115	85	---	5,6	---	5,6	---
27.16	44.09-45.28	33.46	---	12.4	---	12.4	---
69	112-115	85	---	5,8	---	5,8	mit 4980 und Schaft 2313 L
27.16	44.09-45.28	33.46	---	12.8	---	12.8	with 4980 and stock 2313 L
69	112-115	85	---	5,8	---	5,8	---
27.16	44.09-45.28	33.46	---	12.8	---	12.8	---



- Schaffholz Bunt**
Colored stock
- Schaffholz Nuss**
Walnut stock
- Schaffholz Buche**
Hardwood stock
- Aluminium Schaft**
Aluminum stock
- Schaftkappen- und Backenverstellung**
Cheek piece and butt plate adjustment
- Gummschaftkappe**
Rubber butt plate
- Aluminium Schaftkappe 4759**
Aluminum butt plate 4759
- Hakenkappe 2213-8700**
Hook butt plate 2213-8700
- Durchgehende Aluminiumprofilschiene**
Aluminum rail
- ANSCHÜTZ Präzisions-Matchlauf**
ANSCHÜTZ match barrel
- ANSCHÜTZ schwerer Präzisions-Matchlauf**
ANSCHÜTZ heavy match barrel
- Match 54 Verschluss**
Match 54 action
- Match 64 Verschluss**
Match 64 action
- Match-Druckpunktabzug**
Match two stage trigger
- Match-Direktabzug**
Match single stage trigger
- Sicherung**
Safety
- Signalstift**
Signal pin

Hinweis - Note:

Alle Gewichtsangaben ohne Visierung.
Al weights without sight set.
ALU = Aluminium · Aluminum

Griffgrößen · Grip size

XS = Griff extra klein · Pistol grip extra small
S = Griff klein · Pistol grip small
M = Griff mittel · Pistol grip medium
L = Griff gross · Pistol grip large

ANSCHÜTZ



DIE MEISTER MACHER





Nur wer das Unmögliche versucht wird das Optimale erreichen ...
Only the one who tries the impossible will reach the optimum ...

... innovativ, flexibel, kompetent und leistungsbereit fertigen wir seit 1856 Qualitätsprodukte für den Spitzensport.
... Innovative, flexible, competent and dedicated to accuracy – since 1856 we have manufactured high quality products for target shooting.

€ 5.-

Schutzgebühr · Fee

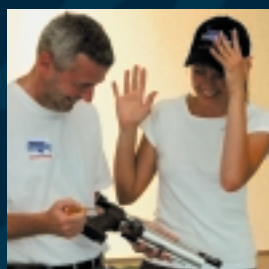
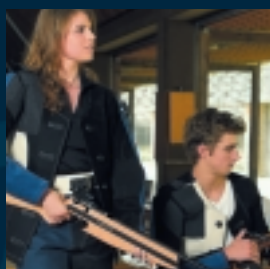
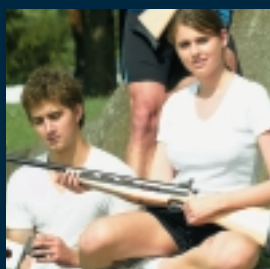

ANSCHÜTZ
®
DIE MEISTER MACHER

J.G. ANSCHÜTZ GmbH & Co. KG
Jagd- und Sportwaffenfabrik

Daimlerstrasse 12
D-89079 Ulm / GERMANY
Postfach 1128
D-89001 Ulm / GERMANY

Fon (++49) - (0) - 7 31 - 40 12-0
Fax (++49) - (0) - 7 31 - 40 12-700
anschuetz-sport.com
JGA-Info@anschuetz-sport.com

OLYMPIC CLASS SPORTERS 2007

SPORTING AND
VARMINT RIFLES

WITH THE
UNMISTAKABLE
ANSCHÜTZ
PERFORMANCE

MADE BY ANSCHÜTZ
MADE IN GERMANY
MADE SINCE 150 YEARS



DIE MEISTER MACHER

ONLY THE ONE WHO TRIES THE IMPOSSIBLE WILL REACH THE OPTIMUM.
INNOVATIVE, FLEXIBLE, COMPETENT AND DEDICATED TO ACCURACY –
SINCE 1856 WE HAVE MANUFACTURED HIGH QUALITY SPORTING AND VARMINT RIFLES.

150 YEARS ANSCHÜTZ - PERFECTION IS TRADITION

"Experience is nothing but memory", wrote the English philosopher Thomas Hobbes. Happy is the one who can take advantage of such a good memory, like the J.G. ANSCHÜTZ company from Ulm who celebrate their 150th anniversary this year.

The reason for the success is due to their technical process, which on the basis of 150 years experience, made the brand ANSCHÜTZ a synonym for precision hunting and target rifles up to this day.

The company was founded by Julius Gottfried Anschütz in 1856 and located in the Thuringian city of Zella-Mehlis until 1945. The founding of the company took place at the beginning of the industrialization period in Germany at a time when many were seeking unity and freedom. The entrepreneurial spirit of the founder and the following generations made the small gunsmith shop grow to become one of the leading companies in Europe for rifle and pistol manufacturing.

World War II put a sudden end to this story of success. Parts of the ANSCHÜTZ family were evacuated to the west part of Germany after the war while the company's possessions were expropriated and dismantled.

The re-establishment of the company in Ulm after the war was due to the overwhelming will of the brothers Max and Rudolf Anschütz. In the new surroundings they prudently lead the company and proved to be veritable successors of their grandfather who founded and developed the "Germania Waffenwerk".

The management of the company remains as then, a family affair. In 1968 Max Anschütz entrusted his son Dieter with the general management who now shares it with his son, Jochen. Since 1856 the "know how" has been part of the family.

Since its foundation, ANSCHÜTZ stands for innovation and perfection. This has not changed through the years. The name ANSCHÜTZ is inseparably connected with innumerable national and international shooting triumphs. Last but not least the pioneering efforts in biathlon shooting have made the name ANSCHÜTZ recognized all over the world.

ANSCHÜTZ products enjoy an extraordinary and worldwide reputation because of their precision, workmanship and accuracy. This is what president Jochen Anschütz - continuing the tradition - puts as a benchmark for the



Jochen Anschütz

future, to ensure that the long history of ANSCHÜTZ continues to give good memories far into the future.



1856



4



6

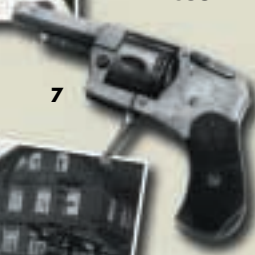

7



8

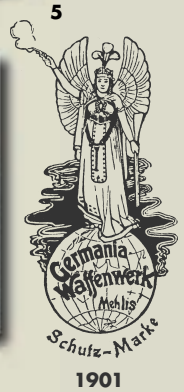

5

1901



9



10



11



12



13



1+2

Julius Gottfried Anschütz and his wife Luise Anschütz founded the company J.G. ANSCHÜTZ Germania Waffenwerk on July 1, 1856.

3

Julius's old JGA trademark.

4

ANSCHÜTZ factory, first construction sector, 1897 with residential house in the background.

5

The "Germania", another trademark of the Germania Waffenwerk from 1901 on.

6

The Anschütz family about 1912 in front of Julius Gottfried's house: on the left side standing you see Fritz August Anschütz, on the right side standing is Otto Veit Anschütz. Luise Anschütz is sitting in the middle.

7

JGA revolver No. 780/781: Hammerless revolver for Browning-Cartridges, cal. 6.75 mm, with screwed-in steel barrel, rifled, with swivelling trigger.

8

Richard Anschütz, the brother of Julius Gottfried (left), his son Robert (2nd from left), and his factory, about 1884.

9

Front page of the net price list to the catalog No. 25, valid from September 10, 1922.

10

Work shop rooms in the old ANSCHÜTZ factory, about 1909.

11

Shooting range, about 1909.

12

Rifle warehouse, 1909.



14



1914

13

Part of the ANSCHÜTZ factory in Zella-Mehlis, about 1944. Dieter and his parents lived underneath the roof of the factory. Dieter's playground was the balcony which was built on the flat roof.

14

Another trademarks of J.G. ANSCHÜTZ from 1914 to 1984.

15

J.G. ANSCHÜTZ youth military training rifle cal. 4 mm long.

16

Wages of the J.G. ANSCHÜTZ during the inflation 1923 of 500.000 Mark, signed by Alma Anschütz (wife of Otto Veit Anschütz), guaranteed by the bank Wachenfeld & Gumprich. The indicated amount could not be cashed. It was only good to buy food, clothing, etc.

17

Hermann Wild, plant manager of the newly founded company J.G. ANSCHÜTZ GmbH in Ulm in 1954 working on a prototype of the new receiver Match 54 under supervision of Rudolf Anschütz.

18

JGA air pistol No. 100, cal. 4.5 mm of Germania Waffenwerk AG.

19

Part view of stock blanks magazine of about 100,000 pieces walnut blanks.

20

Rudolf Charles Anschütz as wood-cutter in the Thuringia forest after the expropriation and dismantling of the company J.G. ANSCHÜTZ Germania Waffenwerk.

21

Gerd Kümme, the first World Champion in air rifle shooting in history. 1966 at the World Championships in Wiesbaden with his ANSCHÜTZ air rifle.

22

August Hollenstein congratulates Gerd Kümme at the World Championships to his gold medal in Wiesbaden, Germany 1966. Both shooters shot an ANSCHÜTZ air rifle 250.

23

The first ANSCHÜTZ target air rifle model 220 with fixed barrel.

24

Training rifle for the new German army after World War II, the small bore model 54, manufactured in 1956.

25

The ANSCHÜTZ family in 2006. Elfi Anschütz (3rd from left, back row) and Dieter Anschütz (on the right next to his wife) and all their family: Jochen Anschütz (3rd from the right) and his brother Uwe (2nd from the left, back row) represent the eleventh generation. Their children are from the right: Tim next to his mother Elke Anschütz, Tim's brother Max and their sister Nina. To her left Uwe's youngest son Moritz, his sister Lena and Uwe's wife Antje Anschütz.



1951



1955



DIE MEISTER MACHER
1984

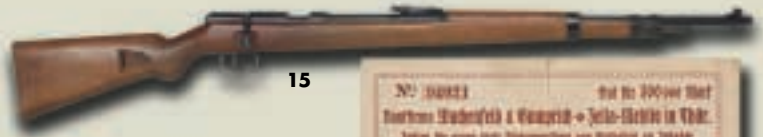

15



16



19



17



20



21



22



23



24



24



25



MAGAZINES AND ACCESSORIES

WARNING:

**Do not use this security keyed gun lock on a loaded gun!
Always keep gun unloaded when not in use and have the bolt open.**



① **Security Keyed Gun Lock Protection**
All ANSCHÜTZ sporters and pistols are delivered with security keyed gun lock protection to prevent unauthorized use of the firearm.
Item No. 711.7250



- Universal in fit.
- Quick, easy release.
- Made from strong Boron Alloy.
- Rubber gaskets protect gun's metal.
- Easy access with reversible keys.
- Complies with applicable laws.

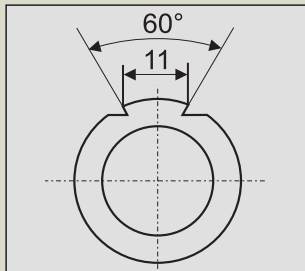

② **All ANSCHÜTZ Olympic Class Sporters have 11 mm receiver rail and are drilled and tapped for scope mounts to fit B-Square, Bushnell, Ironsighter # 91 front and rear, Leupold, Millett Universal 22 TP series, Redfield 47365, Simmons, Talley, Warne 721, Weaver 91 front and rear.**

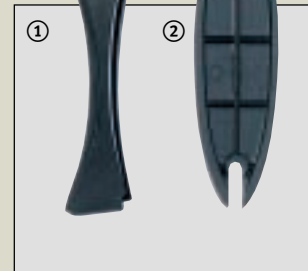

③ **1. Rubber butt plate 4709 B-U1, convex.**
Item No. 710.3710

④ **2. Spacer 4709 P, parallel 8 mm**
Item No. 710.3750



⑤ **3. Sight set 6834, rear sight 6805, front sight 6832 and 7 inserts.**
Item No. 700.0060



⑥ **4. Hand stop 6226, with sling swivel.**
Item No. 710.3600



⑦ **5. Target sling 7400S, synthetic, black.**
Item No. 710.3017



⑧ **6. Single shot adapter 4846, for repeaters caliber .22 long rifle.**
Item No. 710.4700

⑨ **7. Magazine 1420-U5, 5-shot, .22 long rifle.**
Item No. 700.4005

⑩ **8. Magazine 1420-U13, 10-shot, .22 long rifle.**
Item No. 700.4010

⑪ **9. Magazine 54.18 MS R-U2 5-shot, for 1808 stock, .22 long rifle.**
Item No. 700.4260

⑫ **10. Magazine 1515-U3, 4-shot, .22 Win. Magnum .17 HMR.**
Item No. 700.4304

⑬ **11. Magazine 1430-U4, 5-shot, .22 Hornet.**
Item No. 700.4405

⑭ **12. Magazine 1530-U4, 3-shot, .222 Remington.**
Item No. 700.4503

Magazines ⑥ ⑦ ⑧ and ⑨ universal to all ANSCHÜTZ Sporters and Pistols cal. .22 l.r.



150 YEARS ANNIVERSARY VERSION MODEL 1710 D HB CLASSIC

**150 Years Anniversary Version
Model 1710 D HB Classic stainless steel
limited edition:**

Anniversary version of the ANSCHÜTZ hunting repeater 1710 D HB Classic with a number of anniversary extras in limited edition. With heavy, stainless steel barrel manufactured in the famous ANSCHÜTZ special process. A real anniversary edition because the 150 years logo can be found on the back stock, the barrel is decorated with the original "Germania" logo from 1901. Finally the founder's logo from 1856 is engraved in gold on the black steel trigger guard. The trigger blade is also golden. This extraordinary model is completed by a beautifully grained walnut classic stock with two versions of special, high-quality checkering at pistol grip and fore-end. A reliable partner for hunting in renowned ANSCHÜTZ quality and a model for aficionados who want to own the extraordinary.



150 years logo.



JGA founder's logo from 1856.



Original "Germania" logo from 1901.



150 Years Model 1710 D HB Classic,
Heavy Barrel stainless steel



Golden trigger blade.



Checkering.

150 Years Model	Item No. Meister Grade	Caliber	Magazine capacity	Trigger
1710 D HB Classic stainless steel w/o sights	219.4500	.22 l.r.	5-shot	5096 D

Weight	Barrel length (inch)	Length of pull (inch)	Overall length (inch)
8 lbs.	23	14.2	43.3



MODEL 54 MATCH ACTION

The model 54 Match action is the match winner which is the basis for the 1700 series Sporters. It has dominated national, international, and world championships and Olympic Games for over 40 years.

Each 1700 series Sporter is engineered and built with the same attention to workmanship, accuracy and quality as its Olympic target rifle brethren.

Action:

CNC precision machined from a solid block, with the bolt lugs recesses machined eccentrically within the action for proper bedding.

The bolt face is fully recessed for full cartridge head support. Dual locking lugs with claw extractor and cartridge guide insure positive feeding. The bullet head is guided perfectly into the chamber, just like the ANSCHÜTZ Olympic Biathlon competition rifles.

A unique in line, very light firing pin design gives the ANSCHÜTZ 54 Match action the world's fastest lock time.

Grooved, 11 mm receiver rail is drilled and tapped, and will take most American made rings and bases. American tip off mounts are available from B-Square, Millet, Redfield and Blount.

Safety:

Wing type safety completely encloses the firing pin. When activated, it pulls the firing pin back from the bolt face, positively locking it into a safe position.

Trigger:

Single stage (fully adjustable by professional gunsmiths from 2 to 4.4 lbs.). The same Olympic experience and engineering goes into every trigger. True Match quality, they are manufactured to watch makers tolerances, making ANSCHÜTZ triggers unparalleled by any other rifle for lock time, feel, and crispness. Factory set to 2.2 lbs.

Barrel:

8 groove (for rimfire) or 6 groove (for center fire) Olympic Match ANSCHÜTZ target grade, precision chambered, button rifled and lapped to Olympic competition specifications. Target crowned. A test target is included which attests to each individual rifle's accuracy.



ANSCHÜTZ bevel target crown.

Sights:

Folding rear sight adjustable in height in connection with a sporting ramp front sight with bead adjustable in height with hood (where applicable).

Stocks:

1. Classic

Classic styling and sleek, clean lines make these rifles a pleasure to shoot. Stocks are shaped from select straight-grained European walnut, accented by hand checkering at the pistol grip and forearm with border. Grooved black polymer butt plate and swivel studs.

2. Monte Carlo Custom

Unusual grace, beauty and handling blend perfectly with the inherent accuracy of this outstanding rifle. The fine Monte Carlo stock is shaped from European walnut and has a distinctively comfortable, hand-carved roll-over cheek piece for sighting comfort with iron sights or scope. The Wundhammer swell pistol grip is further enhanced by a rosewood grip cap, and both schnabel fore-end and pistol grip are hand checkered in the pattern. Grooved black polymer butt plate with white spacer and swivel studs.

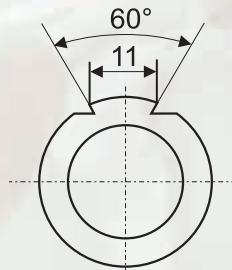
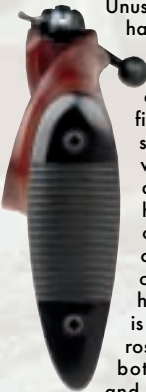

All ANSCHÜTZ Olympic Class Sporters have 11 mm receiver rail and are drilled and tapped for scope mounts to fit

- B-Square.
- Bushnell.
- Ironsighter # 91 front and rear.
- Leupold.
- Millet Universal 22 TP series.
- Redfield 47365.
- Simmons.
- Talley.
- Warne 721.
- Weaver 91 front and rear.

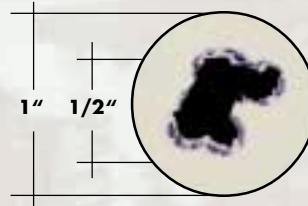

Typical 1710:
10-shot .22 l.r. test fire group at 55 yards.



Typical 1717:
5-shot .17 HMR test fire group at 55 yards.



Typical 1730:
3-shot .22 Hornet test fire group at 110 yards.



Typical 1702:
5-shot .17 Mach 2 test fire group at 55 yards.

All ANSCHÜTZ firearms are delivered with a security keyed gun lock
Item No. 711.7250
as shown on page 4



54 Match Action with target knob.

MODEL 54 MATCH ACTION - 1700 SERIES SPORTERS

Varmint rifles with the unmistakable ANSCHÜTZ performance



DIE MEISTER MACHER



Model 1712 Silhouette Sporter Monte Carlo



- .22 l.r., 5-shot magazine.
- Eccentrically mounted bolt.
- Dual locking lugs, cam cocking, claw extractor, recessed bolt face for cartridge head support.
- Firing pin lock safety.
- Two stage Match Grade target trigger factory set to 2.2 lbs. with adjustable lop.
- 11 mm grooved receiver, drilled and tapped for scope mounts.
- Match Grade 21.6" barrel, precision rifled, lapped, Match target crowned and free floated.
- Muzzle diameter 0.7".
- Weight 7.3 lbs.



Model 1702 D HB Classic, Heavy Barrel
Model 1710 D HB Classic, Heavy Barrel
Model 1717 D Classic
Model 1717 D HB Classic, Heavy Barrel
Model 1730 D HB Classic, Heavy Barrel



- 23" Match Grade heavy barrel (muzzle diameter 0.83").
- Weight 8 lbs.
- Single stage trigger, Match Grade.
- Classic stock.
- Checkered semi-fancy or Meister Grade walnut.



Model 1710 D KL Monte Carlo
Model 1717 D KL Monte Carlo
Model 1730 D KL Monte Carlo



- 23" barrel (muzzle diameter 0.7").
- With folding rear sight and ramp front sight.
- Weight 7.5 lbs.
- Single stage trigger, Match Grade.
- Monte Carlo roll over cheek piece stock.
- Checkered semi-fancy or Meister Grade walnut.

Model	Item No. Semi-fancy	Item No. Meister Grade	Caliber	Magazine capacity	Length of pull (inch)	Overall length (inch)
1702 D HB Classic w/o sights	242.2095	---	.17 Mach 2	5-shot	14.2	43.3
1710 D HB Classic w/o sights	220.2095	220.2096	.22 l.r.	5-shot	14.2	43.3
1717 D Classic w/o sights	222.2091	222.2093	.17 HMR	4-shot	14.2	43.3
1717 D HB Classic w/o sights	222.2095	222.2096	.17 HMR	4-shot	14.2	43.3
1730 D HB Classic w/o sights	340.2095	340.2096	.22 Hornet	5-shot	14.2	43.3
1710 D KL Monte Carlo	220.2030	220.2040	.22 l.r.	5-shot	14.2	43.3
1712 Silh. Sporter Monte Carlo w/o sights	220.1033	---	.22 l.r.	5-shot	13.8 ± adjustable	40.9
1717 D KL Monte Carlo	222.2030	222.2040	.17 HMR	4-shot	14.2	43.3
1730 D KL Monte Carlo	340.2030	340.2040	.22 Hornet	5-shot	14.2	43.3

R = Repeater **D** = Single stage trigger **L** = Left hand version **KL** = Folding leaf sight **HB** = Heavy Barrel **MPR** = Multi Purpose Repeater



MODEL 64 MATCH ACTION

1416/1516/1502/1517 Series Sporters:

The Model 64 Match action is a lighter action than the Model 54, but still retains full ANSCHÜTZ match quality workmanship, accuracy and perfection and is used also for our 1903 target rifles.

64 Match action:

CNC precision machined with cam cocking bolt. The bolt face is fully recessed for full cartridge head support. Target type ball on bolt handle. Claw extractor and cartridge guide ensure positive feeding. The bullet head is guided perfectly into the chamber, just like the ANSCHÜTZ Olympic Biathlon competition rifles. Grooved, 11 mm receiver rail is drilled and tapped, and will take American made rings and bases.

Barrel:

8 groove Olympic Match ANSCHÜTZ target grade, precision chambered, and button rifled to Olympic competition specifications. Target crowned. A test target is included with all Models 64 MPR which attests to individual rifle accuracy.

Trigger:

2.5 lbs. single stage trigger 5094. Fully adjustable by professional gunsmiths from 2 to 4.4 lbs. The trigger is the same as used in the ANSCHÜTZ 1903 target rifle. Factory set to 2.5 lbs.

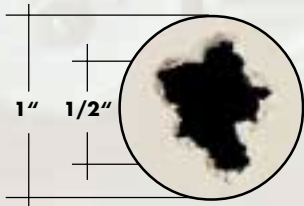

Safety:

Lateral sliding safety disables the trigger, allowing unloading in the "Safe" position.

Stocks:

1. Classic

Elegant Classic straight lines, shaped from European walnut, checkering at pistol grip and forearm with black polymer butt plate and swivel studs accent the unique appearance.

2. Classic Beavertail

The handsome American Classic line is shaped out of European walnut, combined with a distinctively beautiful Beavertail forend which gives this stock an extraordinary appearance. The exclusive ANSCHÜTZ silken mat finish of this stock and the cut checkering at the pistol grip provides both beauty and protection.

3. Monte Carlo Custom

Monte Carlo walnut stock with Schnabel tipped forearm and modified European style Monte Carlo comb and cheek piece. Pistol grip and forearm are finely checkered, black polymer butt plate with checkering and white spacer and swivel studs.

Sights:

Folding rear sight is adjustable in height as is the hooded sporting ramp front sight.

Typical Target 1416:

10-shot .22 l.r. test fire group at 55 yards.

Typical Target 1502:

5-shot .17 Mach 2 test fire group at 55 yards.

Typical Target 1516:

5-shot .22 WMR test fire group at 55 yards.

Typical Target 1517:

5-shot .17 HMR test fire group at 55 yards.

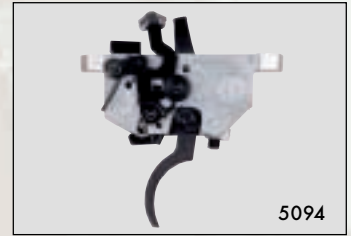
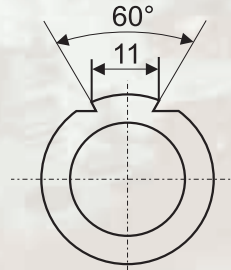

All ANSCHÜTZ Olympic Class Sporters have 11 mm receiver rail and are drilled and tapped for scope mounts to fit

- B-Square.
- Bushnell.
- Ironsighter # 91 front and rear.
- Leupold.
- Millett Universal 22 TP series.
- Redfield 47365.
- Simmons.
- Talley.
- Warne 721.
- Weaver 91 front and rear.

All ANSCHÜTZ firearms are delivered with a security keyed gun lock Item No. 711.7250 as shown on page 4

64 Match Action with target knob.

MODEL 64 MATCH ACTION - SPORTERS

Outstanding rimfire rifles, born of world-famous ANSCHÜTZ target rifle technology and crafted for world-class field shooting accuracy.



- Model 1416 D KL Classic**
- Model 1416L D KL Classic**, left hand version
- Model 1502 D HB Classic**, w/o sights
- Model 1516 D KL Classic**
- Model 1517 D Classic**, w/o sights
- Model 1517L D Classic**, w/o sights, left hand version



- 23" barrel.
(muzzle diameter 0.63 in.).
- Adjustable folding rear sight.
- Weight: 5.5 lbs.
- Single stage trigger 2.5 lbs.
- Classic stock, checkered walnut.



- Model 1416 D HB Classic Beavertail**, Heavy Barrel
- Model 1502 D HB Classic Beavertail**, Heavy Barrel
- Model 1517 D HB Classic Beavertail**, Heavy Barrel



- 23" heavy barrel.
(muzzle diameter 0.75 in.).
- Weight: 6.2 lbs.
- Single stage trigger 2.5 lbs.
- Classic Beavertail stock, walnut, checkering at pistol grip.



Model	Item No. Semi-fancy	Item No. Meister Grade	Caliber	Magazine capacity	Length of pull (inch)	Overall length (inch)
1416 D KL Classic	217.2020	---	.22 l.r.	5-shot	14.0	41 1/2
1416L D KL Classic, left hand version	217.3060	---	.22.l.r.	5-shot	14.0	41 1/2
1416 D HB Classic Beavertail, w/o sights	217.4005	---	.22 l.r.	5-shot	14.0	41 1/2
1502 D HB Classic, w/o sights	240.2095	---	.17 Mach 2	5-shot	14.0	41 1/2
1502 D HB Classic Beavertail, w/o sights	240.4005	---	.17 Mach 2	5-shot	14.0	41 1/2
1516 D KL Classic	231.2020	---	.22 WMR	4-shot	14.0	41 1/2
1517 D Classic, w/o sights	221.2023	---	.17 HMR	4-shot	14.0	41 1/2
1517L D Classic, w/o sights	221.3095	---	.17 HMR	4-shot	14.0	41 1/2
1517 D HB Classic Beavertail, w/o sights	221.4005	---	.17 HMR	4-shot	14.0	41 1/2

R = Repeater **D** = Single stage trigger **L** = Left hand version **KL** = Folding leaf sight **HB** = Heavy Barrel **MPR** = Multi Purpose Repeater



MODEL 64 MATCH ACTION FOR THE MULTI PURPOSE SERIES

These models represent the finest example of a quality moderately priced match rifle. The rifle is built on the fine 64 Match action coupled to a full size target barrel.

The model 64 MP R Multi Purpose is equipped with the two stage Match trigger 5098, factory set to 10 oz.

The model 1517 MP R Multi Purpose is equipped with the two stage Match trigger 5106, factory set to 1 lbs 9 oz.

Both triggers are fully adjustable (by a qualified gunsmith only!) for weight, creep, and length of pull.

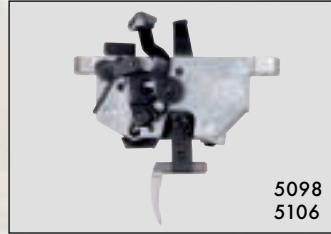

Model 64 MP R Multi Purpose
Model 1517 MP R Multi Purpose
shown with accessories, as shown on page 4.

- 25 1/2" heavy Match barrel diam. 0.89 in.
- Weight: 9 lbs.
- .22 long rifle - 5-shot magazine for .17 HMR - 4-shot magazine.
- Two stage Match Grade target trigger with adjustable lop; for 64 MP R 10 oz. for 1517 MP R 1 lbs 10 oz.
- Beavertail hardwood stock with adjustable butt plate and accessory rail with insert.
- 11 mm grooved receiver rail, drilled and tapped for scopes and target sights.



Adjustable rubber butt plate with 1/3 inch spacer.



Accessory rail with black removable insert.

All ANSCHÜTZ firearms are delivered with a security keyed gun lock Item No. 711.7250 as shown on page 12



Model	Item No.	Caliber	Magazine capacity	Length of pull (inch)	Overall length (inch)
64 MP R Multi Purpose	219.4002	.22 l.r.	5-shot	13.8 + 1/3 spacer	43.3
1517 MP R Multi Purpose	221.4102	.17 HMR	4-shot	---	41 1/2

R = Repeater **D** = Single stage trigger **L** = Left hand version **KL** = Folding leaf sight **HB** = Heavy Barrel **MP R** = Multi Purpose Repeater



MODEL 64 R SPORTER TARGET

ANSCHÜTZ Sport and Target Repeater:

64 Match action

Bolt action repeater, with detachable 10-shot magazine. Action is cam cocking with claw extractor and cartridge holder, recessed bolt face for full cartridge head support. Sliding safety.

A great quality moderately priced ANSCHÜTZ medium weight target rifle for intermediate and advanced Junior Match competitions when fitted with

basic target rifle accessories like the ANSCHÜTZ 6834 micrometer sight set, 6226 position hand stop and 4846 single shot magazine block adapter. The target stock fits right and left hand shooters, is vertically and horizontally adjustable at the butt plate, which can be extended with additional 1/3" thick spacers. 2 spacers come with the rifle.

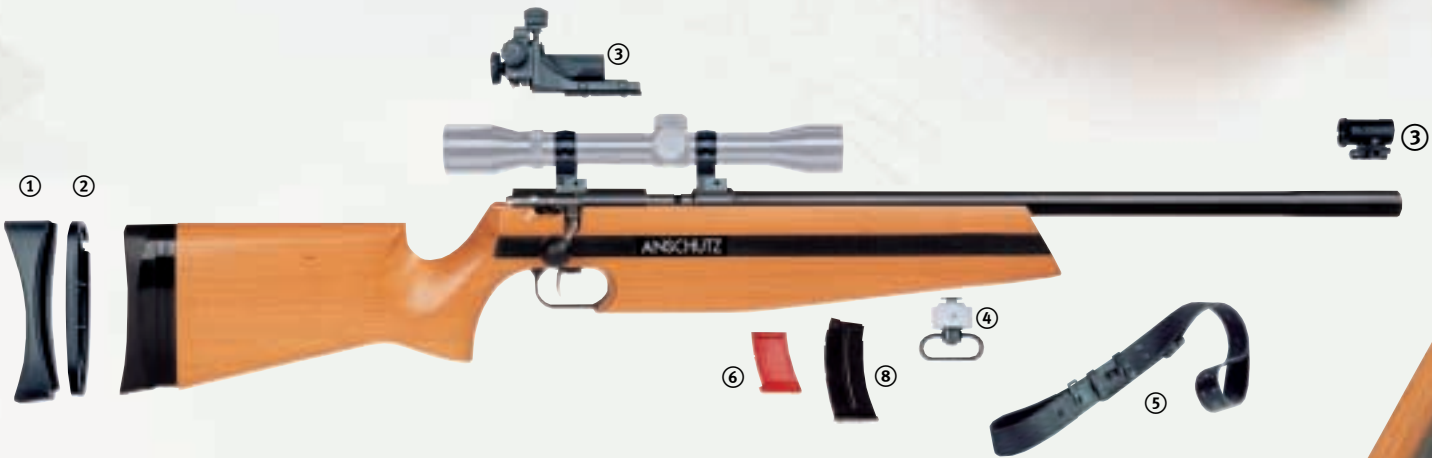

Model 64 R Sporter Target shown with accessories, as shown on page 4.

The ergonomic pistol grip is stippled. The forearm has an aluminum target rail for target rifle accessories like a hand stop. The 21 1/4" heavy target barrel with 0.87 muzzle diameter is grooved for ANSCHÜTZ target front sight and chambered and rifled to ANSCHÜTZ target barrel specifications. The "ANSCHÜTZ Accurate" 64 R Sporter Target is ready to go right out of the box, you don't need to add other market target barrels, target stocks or rework the trigger.

Trigger:

Two stage Match trigger 5098, factory set to 10 oz.



To convert the rifle for varmint hunting or plinking, just install a scope on the 11 mm grooved receiver.



Accessory rail with black removable insert.

Model	Item No.	Caliber	Magazine capacity	Weight
64 R Sporter Target	219.4500	.22 l.r.	10-shot	7.7 lbs.

Barrel length (inch)	Length of pull (inch)	Overall length (inch)	Sight
21.4	12 1/3 + 2 x 1/3 spacer	39.4	optional

ANSCHÜTZ SPORTING RIFLES

ANSCHÜTZ Sporting Rifles are assuredly among the most accurate, if not the most accurate and precisely made small bore firearms in the world! ANSCHÜTZ Sporters are assembled with the same precision rifling, the same bolt assemblies (sporterized in scale), by the same ANSCHÜTZ craftsmen, using the same manufacturing equipment and assembly processes with quality standards as used in the manufacture of the world famous and record setting ANSCHÜTZ Target Rifles. The best small bore shooters in the world have been winning and setting world records with ANSCHÜTZ for the past fifty years.

ANSCHÜTZ firearms and "ANSCHÜTZ ACCURACY" are not for everyone. If you want an adequately accurate rifle that is capable of hitting a tin can size target at 25 to 50 yards you do not need "ANSCHÜTZ ACCURACY." If you are a discriminating shooter and appreciate fine craftsmanship, precise function and demand world class accuracy that will consistently hit dime sized targets at 50 yards or "off hand" silhouettes at 100 yards - you need "ANSCHÜTZ ACCURACY."

ANSCHÜTZ IMPORTED AND SERVICED BY



Merkel USA, Inc.
7661 Commerce Lane
Trussville, AL 35173

205-655-8299
205-655-7078 Fax
www.merkel-usa.com



FIND YOUR DEALER AT WWW.ANSCHÜTZ-SPORTERS.COM

ANSCHÜTZ Sporters and Sporting accessories are available through leading firearms dealers. If your local dealer does not inventory the ANSCHÜTZ rifle you are interested in, then find your ANSCHÜTZ dealer through Merkel USA, Inc. or the following Distributors:

AcuSport Corporation
One Hunter Place
Bellefontaine, OH 43311-3001
800-543-3150
937-592-5625 Fax

Bangers
10 South 14th Street
Birmingham, AL 35233
205-324-8915
205-521-0913 Fax

Bill Hicks & Co., Ltd.
15155 23rd Avenue North
Minneapolis, MN 55447
800-223-0702
763-476-0676 Fax

Ellett Brothers Inc.
267 Columbia Ave
Chapin, SC 29036-8322
800-845-3711
803-345-1820 Fax

RSR Group
4405 Metric Drive
Winter Park, FL 32792
800-541-4867
407-677-4489 Fax

Sport South, Inc.
1039 Kay Lane
Shreveport, LA 71115
800-388-3845
318-797-7678 Fax

Zanders Sporting Goods
7525 State Route 154
Baldwin, IL 62217-9706
800-851-4373
618-785-2320 Fax

ANSCHÜTZ TARGET RIFLES ARE AVAILABLE THROUGH
Champion's Choice 800-345-7179; Champion Shooters Supply 800-821-4867;
Gunsmithing Inc. 800-284-8671; Creedmoor Sports 760-757-5529

FACTORY SERVICE, PARTS & REPAIR CENTERS

For Sporters:
Merkel USA, Inc.
7661 Commerce Lane
Trussville, AL 35173
205-655-8299
205-655-7078 Fax
www.merkel-usa.com

For Target Line:
Gunsmithing, Inc.
30 West Buchanan Street
Colorado Springs, CO 80907
719-632-3795
719-632-3493 Fax

For Target Line:
10-Ring Service, Inc.
2227 West Lou Drive
Jacksonville, FL 32216
904-724-7419
904-724-7419 Fax

Note:

Product specifications, design and model changes are subject to change without prior notice. Dimensions and colors are subject to change. With reservation of misprints and errors. Goods are subject to prior sale. **Delivery subject to the presentation of the referring license for the purchase of firearms.** ANSCHÜTZ, the ANSCHÜTZ logo and the ANSCHÜTZ logo in connection with the slogan "Die Meister Macher" (also in modified spelling) are protected and registered trademarks of J.G. ANSCHÜTZ GmbH & Co. KG, Ulm, Germany. The unauthorized use of this brand name is not allowed and punishable. All rights of this catalog reserved. The use of the catalog, also in excerpts, is not allowed without the permission of J.G. ANSCHÜTZ GmbH & Co. KG and otherwise is punishable. This is especially applicable for unauthorized copying, translations and read-ins into electronic systems.

WWW.ANSCHÜTZ-SPORTERS.COM • WWW.ANSCHÜTZ-SPORT.COM

J.G. ANSCHÜTZ GmbH & Co. KG · P.O. Box 1128 · D-89001 Ulm, Germany · www.anschuetz-sport.com · e-mail: JGA-Info@anschuetz-sport.com



Not just new — the best ever!



ANSCHÜTZ®

DIE MEISTER MACHER

The World Sensation from ANSCHÜTZ!



Picture with accessories

Only real innovations and an absolutely new technology lead you to the best results!

ANSCHÜTZ realized exactly this. The world's best shooters contributed to the development of the new ANSCHÜTZ target compressed air rifle **9003 Premium**. ANSCHÜTZ thus created a product that will be the new definition for top class target compressed air rifles.



9003 Premium

7-fold patented resp. patent pending.

- Tension free connection and vibration damping fixing of the barrelled action in the aluminum carrier through Soft-Link® shock absorber pads.
- Absolutely maintenance-free stabilizer working in-line with the shot release.
- Ultra-short lock time by a new striking piece and a completely new developed, mechanical trigger.
- New and innovative safety concept for the loading process.
- Dry-firing device with an active safety lock.
- Infinitely variable adjustable forend (height, swivel).
- Complete PRO-Grip equipment (anti-allergic technical material with a nicely grained black design).
- Air filter which avoids impurities.
- Outstanding cheek piece and butt plate adjustment.
- Various stock decoration stickers to choose from.
- Also available as bench rest version.

ANSCHÜTZ
DIE MEISTER MACHER

The Technology...



The technology

Tension free connection and vibration damping fixing of the barreled action in the aluminum stock through patent-pending **Soft Link® shock absorber pads** and **absolutely maintenance-free stabilizer** working axially to shot release.

Ultra-short lock time due to compound materials, optimized firing pin and **new trigger unit**.

New and innovative safety concept. The action will be cocked just before the cocking lever is closed.

Forend stock adjustable in height, length and angle as well as complete **PRO-Grip equipment**.

This ANSCHÜTZ masterpiece is completed by a variety of high-quality **accessories**.

The special highlight!

Be the designer of your new target compressed air rifle stock! Every **9003 Premium** is delivered with seven pairs of different high-quality stock decoration stickers. Choose which of them fits your personal **9003 Premium** most. The stickers can easily be removed if you feel like giving your stock a new outfit.

Caliber 4,5 mm / .177	Barrel length 64 cm / 25.2"
Rifling 42 cm / 16.5"	Total length 108 cm / 42.5"
Length of barreled action 78 cm / 30.7"	Weight approx. 4,5 kg / 9.9 lbs
Version Single loader	Stock ALU black ALU carrier PRO-Grip carrier parts
Color black	Butt plate 4759
Item No. 560.4990 560.4995 560.4940 560.4941	(large pistol grip) (medium pistol grip) (large pistol grip bench rest) (medium pistol grip bench rest)

Delivered with:

Apart from the target compressed air rifle **9003 Premium** the beautifully designed rifle case contains an accessory box containing the following items:

Soft Link® shock absorber pads, additional weights, filling adapter with air release screw, special grease, air release screw, hex keys, instruction leaflet with original test target, the new service manual ...

... and the stock design stickers as described above.



Your 9003 Premium dealer will be pleased to advise you.

ANSCHÜTZ
®

DIE MEISTER MACHER

J.G.ANSCHÜTZ GmbH & Co.KG
Jagd- und Sportwaffenfabrik
Daimlerstrasse 12 · D-89079 Ulm/Germany
Phone +49 (0) 731/4012-0 · Fax +49 (0) 731/4012-700
anschuetz-sport.com
JGA-Info@anschuetz-sport.com