

2006



WILLIAMS
GUN SIGHT COMPANY INC.

80 YEARS ON THE RANGE

Bringing New
Technology and Time
Honored Craftsmanship
Together since 1926.

**MADE IN THE
U.S.A.**



BLACKPOWDER ONLY
MADE IN U.S.A.

TABLE OF CONTENTS

FIRE SIGHTS FOR PISTOLS	3	WGOS SERIES REAR OPEN SIGHT	16
FIRE SIGHTS FOR SHOTGUNS	4, 5	RAMPS	17, 18
FIRE SIGHT PEEP SETS	6	RIFLE BEADS	6, 17, 28
FIRE SIGHTS FOR RIFLES	7	RAMP HOODS.....	18
FIRE SIGHTS FOR MUZZLELOADERS	8	MUZZLELOADER SCOPE MOUNTS.....	19-21
MILITARY SIGHTS.....	9	SCOPE MOUNTS	19-23
FP SERIES RECEIVER SIGHTS.....	10, 11	SLING SWIVELS	24, 25
5D SERIES RECEIVER SIGHTS	12	GUNSMITHING TOOLS	26, 27
WGRS SERIES RECEIVER SIGHTS	13	SHOTGUN BEADS	4, 27
TARGET RECEIVER SIGHTS	14, 15	ACCESSORIES	28, 29
APERTURES.....	14, 28	GUNSMITHING SERVICES.....	30-32
GLOBE FRONT SIGHT.....	14	CHARTS	34-36

*W*elcome to our 2006 Williams Product Catalog. We're in our 80th year of producing a quality line of gun sights and we're excited about the new look of our catalog this year. We've combined our former Fire Sight brochure with our full line catalog for easier customer reference.

Inside you'll find many of the same classic gunsights that generations of shooters have come to expect from Williams. We've also continued to add to our extensive selection of fiber optic sights which is already among the most comprehensive in the firearms industry. Over the past five years we have embarked on an aggressive updating of our manufacturing facilities. With the help of computerized machining centers, we are improving the precision and quality of our traditional product lines while adding models of sights and accessories

to keep pace with the firearms industry. If you can't find your particular firearm listed, visit our website or please call our customer service department as they can readily assist you in determining which combinations or our sights or accessories will fit your model of firearm

Thank you for helping us to continue the Williams tradition.





PISTOL FIRE SIGHTS

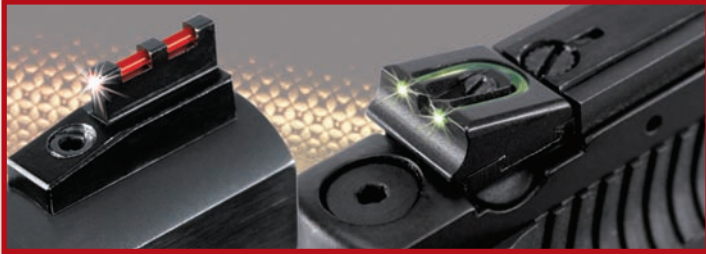

BROWNING BUCKMARK FIRE SIGHT SET

Replaces newer style Browning Buckmark .22 front and rear sights. Fully adjustable metallic sights. No gunsmithing required. (excludes: Target, 5.5 Field & Target, Challenge & Commemorative models.)

ITEM	PRICE
70231 Rear sight length over 1" long	\$45.95
70232 Rear sight length less than 1" long	\$45.95



RUGER MKII/MKIII FIRE SIGHTS

Fits Ruger MKII and MKIII 5-1/2" Bull Barrel front and rear. Also fits Government, Slabside and 22/45 models. Gunsmith installation recommended. Order item 66649



TAURUS

ITEM	PRICE
70268 Fits Taurus, PT111, PT140, PT145, PT132, PT138 (Millennium and Millennium Pro).....	\$45.95

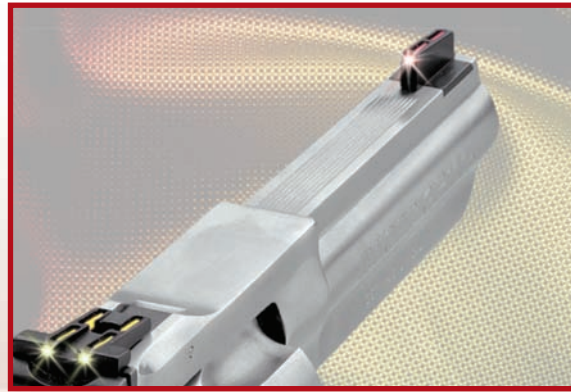

RUGER ADJUSTABLE REVOLVER FIRE SIGHTS

Fixed front and adjustable rear metallic fiber optic Fire Sights. The rear sight retro-fits to the existing Ruger rear adjustable base. Fits the GP100, Redhawk and Super Redhawk. Gunsmith installation recommended. Order item 60216



FIXED SEMI AUTO PISTOL FIRE SIGHTS

One of our original Fire Sights, the Semi-Auto Pistol Fire Sight is excellent for targets and defense.

ITEM	FIXED SIGHT MODELS	PRICE
56359	Fits all Glocks	\$45.95
NEW! 70864	Ruger P345 & KP345.....	\$45.95
56360	Fits all Ruger P-Series (excluding P-85).....	\$45.95
56361	FitS&W 910.....	\$45.95
56362	Fits Colt Government Model Series 80.....	\$45.95
60215	Fits Sig Sauer Front Fire Sight Only	\$22.95
70272	Fits Springfield XDs	\$45.95

ITEM	ADJUSTABLE SIGHT MODELS	PRICE
60216	Fits Ruger GP100, Redhawk, and Super Redhawk, Super Blk. Hunter....	\$45.95
66649	Ruger MKII and MKIII Bull Barrel, Govt. , Slabside & 22/45	\$45.95
70104	Ruger MKII and MKIII 6-7/8 Taper Barrel ...	\$45.95
70235	Ruger New Model Single Six .22LR	\$45.95

SHOTGUN FIRE SIGHTS

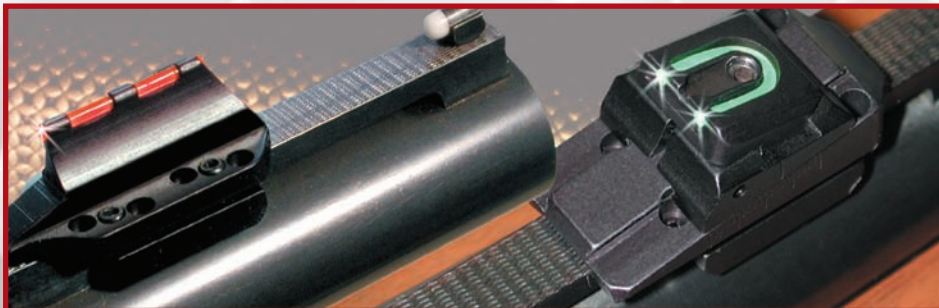

UNIVERSAL VENT RIB "SLUGGER" SHOTGUN FIRE SIGHT SET

One size fits all. Front and rear metallic sights attach to virtually all vent ribs. Adjustable for windage and elevation. No gunsmithing required.

<u>ITEM</u>	<u>PRICE</u>
70230.....	\$39.95

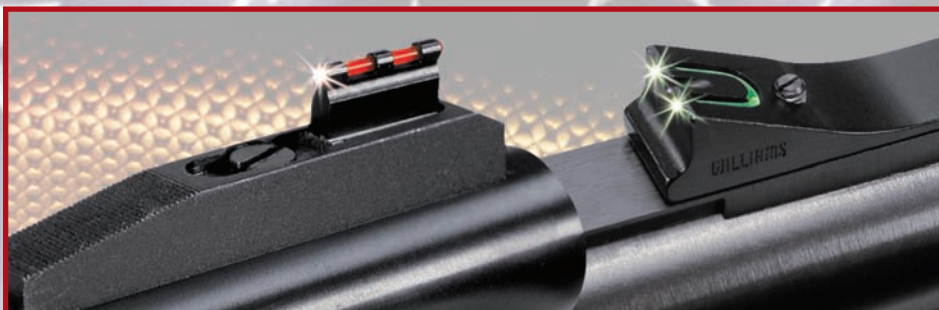

ITHACA 37 DEERSLAYER FIRE SIGHT SET

Replaces rear sight and front bead on existing factory sights. No gunsmithing required. Fully adjustable metallic sights.

<u>ITEM</u>	<u>PRICE</u>
70234.....	\$35.95

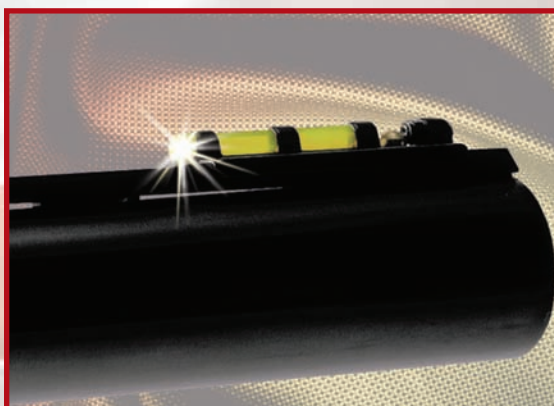

VENTILATED RIB FIRE SIGHT BEAD

Fire yellow, for a great sight picture. No gunsmithing required.

<u>ITEM</u>	<u>RIB WIDTH</u>	<u>PRICE</u>
56446	1/4"	\$16.95
56447	5/16"	\$16.95
56448	3/8"	\$16.95

**VISIT US
ON THE
WEB AT:**
WWW.WILLIAMSGUNSIGHT.COM



SHOTGUN FIRE SIGHTS

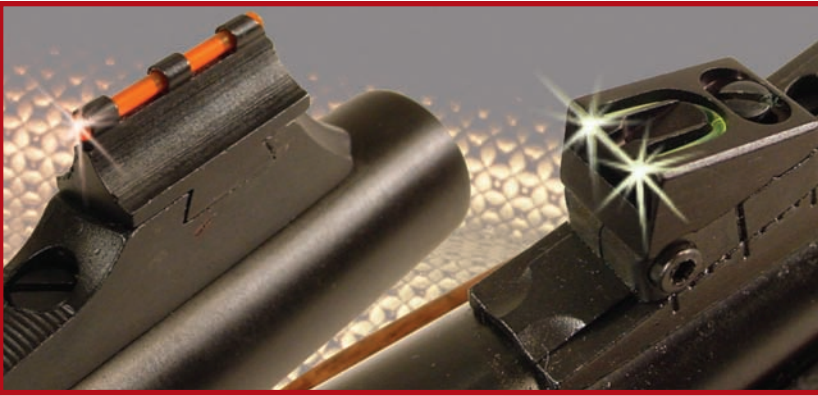

REMINGTON FIRE SIGHT SET

Rear sight fits most newer style Remington sight bases. Steel front bead fits newer front sight ramps. Great for Remington Turkey and Slug Gun. No gunsmithing required.

<u>ITEM</u>	<u>PRICE</u>
56530 Fits Pre 2003 Rifles, Muzzleloaders, all shotguns...	\$29.95
70267 Fits Post 2003 Rifles and Muzzleloaders with 1-Pc. Ramp	\$29.95

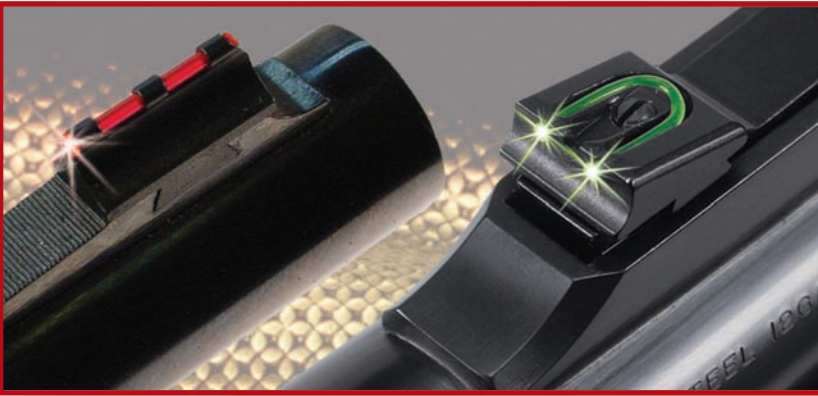

BROWNING BPS FIRE SIGHT SET

Replaces rear sight insert and front bead on existing factory sights. Fully adjustable metallic sights. No gunsmithing required.

<u>ITEM</u>	<u>PRICE</u>
70233 Browning BPS	\$37.95
70239 Browning BLR	\$37.95

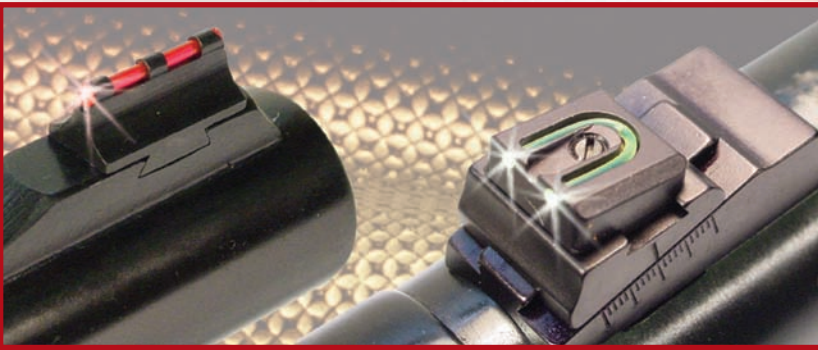

MOSSBERG 500 FIRE SIGHT SET

Front and rear Fire Sights fit Mossberg 500 with existing factory installed Williams rear sight.

<u>ITEM</u>	<u>PRICE</u>
66370	\$33.95



WINCHESTER 1300 FIRE SIGHT SET

Front and rear Fire Sights fit Winchester 1300 with factory installed open sights. Rear sight fully adjustable for windage and elevation.

<u>ITEM</u>	<u>PRICE</u>
66651	\$34.95

FIRE SIGHT PEEP SETS



RIFLE FIRE SIGHT PEEP SETS

Customize your rifle with a Fire Sight Steel front bead and the popular Williams WGRS rifle peep sight. The rear sight is fully adjustable with no drilling and tapping required.

ITEM	PRICE
63330...Ruger 22	\$47.95
70017...Ruger 99/44	\$47.95
70018...Marlin 336	\$47.95
70019...Ruger 96/22, 96/22 Mag.....	\$47.95



SKS RIFLE FIRE SIGHT SET

Combines the Fire Sight front bead with Williams fully adjustable metallic rear sight for an incredible sight picture. No gunsmithing required.

ITEM	PRICE
63464	\$39.95
60214 ...Front Fire Sight Only	\$19.95



LEVER ACTION FIRE SIGHT PEEP SETS

Outfit your Winchester or Marlin centerfire lever action rifle with a new Fire Sight steel bead and our ever popular Williams FP or 5D series sights. Pre-packaged set for savings and convenience.

ITEM	PRICE
63331 ...FP 94.....	\$80.95
70102 ...FP Marlin 450	\$80.95
70103 ...FP Winchester 94SE.....	\$80.95
70282 ...FP Marlin 336	\$80.95
(uses rear scopemount holes)	
NEW! 70859 ...5D-94 - For Win 94 top eject.....	50.95
NEW! 70860 ...5D-94SE	50.95
For Win 94 side eject w/ramped front sight	
NEW! 70862 ...5D-94SE Ranger	50.95
For Win 94 side eject with dovetail cut in barrel front sight	
NEW! 70861 ...5D-336 - For Marlin 336.....	50.95
(Mounts using scope mount holes)	

FIRE SIGHT RIFLE BEADS

Steel front dovetail sight beads machined to accept Fire Sight light gathering rod. A must for all shooters in low light situations. Comes in a variety of heights.

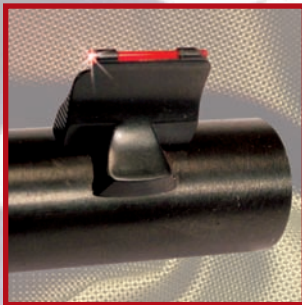

ITEM	HEIGHT	PRICE
59080	500W	\$17.95
59081	538W	\$17.95
59082	570W	\$17.95
59083	375W	\$17.95
59084	410W	\$17.95
59079	450W	\$17.95

ITEM	HEIGHT	PRICE
56432	250N	\$17.95
56433	290N	\$17.95
56434	312N	\$17.95
56435	343N	\$17.95
56436	375N	\$17.95
56437	406N	\$17.95
56438	450N	\$17.95

ITEM	HEIGHT	PRICE
56439	250M	\$17.95
56440	290M	\$17.95
56441	312M	\$17.95
56442	343M	\$17.95
56443	375M	\$17.95
56444	406M	\$17.95
56445	450M	\$17.95
60237	538M	\$17.95
60238	570M	\$17.95

NOTE: INSTALLATION OF DOVETAILED FRONT SIGHTS IN RAMPS AND ESPECIALLY DOVETAILED BARRELS ALMOST ALWAYS REQUIRES SOME MINOR FITTING. GUNSMITH INSTALLATION IS RECOMMENDED.

(N) .250 NARROW WIDTH IS FOR WILLIAMS STREAMLINED AND SHORTY RAMPS..

(M) .340 MEDIUM WIDTH IS FOR FACTORY RAMPS SUCH AS MARLIN, REMINGTON ETC.

(W) .531 WIDE WIDTH IS FOR DOVETAILED BARRELS COMMONLY FOUND ON .22 RIFLES AND MUZZLELOADERS..

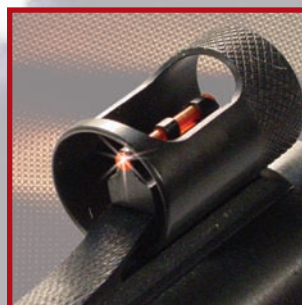

ITEM	PRICE
70031	\$9.50

For Williams Streamlined Ramps.

FIRE SIGHT ASSORTMENT KIT

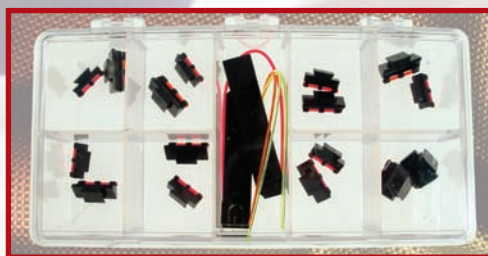

SAVINGS and SELECTION

For the gunsmith or shooting enthusiast. This kit contains our most popular Fire Sight beads, rear dovetail Fire Sight, and fibers only for repairs and custom work. Take advantage of the kit price savings.

PRICE\$169.95

KIT INCLUDES:

- 2 Fire Sight rifle beads (one narrow and one medium)250
- 2 Fire Sight rifle beads (one narrow and one medium)290
- 2 Fire Sight rifle beads (one narrow and one medium)312
- 2 Fire Sight rifle beads (one narrow and one medium)343
- 2 Fire Sight rifle beads (one narrow and one medium)375
- 2 Fire Sight rifle beads (one narrow and one medium)406
- 2 Fire Sight rifle beads (one narrow and one medium)450
- 1 Fire Sight rifle bead538 wide
- 1 Fire Sight rifle bead570 wide
- 2 Rear dovetail Fire Sights
- 2 Six inch fiber only .040 diameter (one red and one green)
- 2 Six inch fiber only .060 diameter (one red and one green)

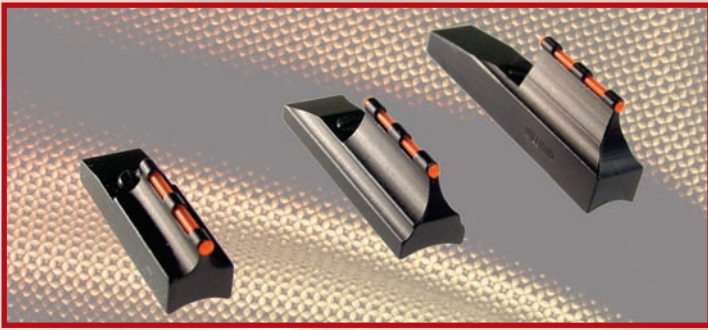

1-PC FIRE SIGHT RAMPS

These metallic ramps can be used to replace many of the plastic ramps on the market. Attaches with one 6-48 screw.

ITEM	HEIGHT	BARREL DIAMETER	PRICE
70105	.410	.625	17.95
NEW! 70749	.445	.875	17.95
70220	.485	.875	17.95
70678	.634	.650	17.95

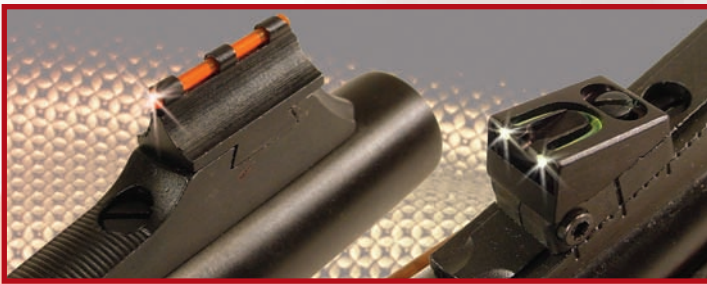

REMINGTON RIFLE FIRE SIGHT SETS

Rear sight fits most newer style Remington sight bases. Steel front bead fits new style front sight ramps.

ITEM	PRICE
56530 Fits Pre 2003 rifles, Muzzleloaders, all shotguns	\$29.95
70267 Fits Post 2003 rifles and Muzzleloaders with 1-PC Ramp	\$29.95
70101 597 Open Sight Set	\$32.95

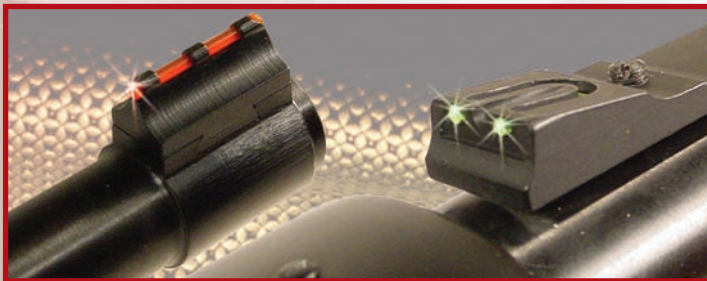

RUGER 10/22 FIRE SIGHT SET

Customize your 10/22 with front and rear fiber optic Fire Sights. The front steel bead and the fully adjustable metallic rear sight are CNC machined for a perfect fit. Also fits Ruger 96-22. No gunsmithing required.

ITEM	PRICE
60213	\$24.95

FIRE SIGHT RIFLE SETS

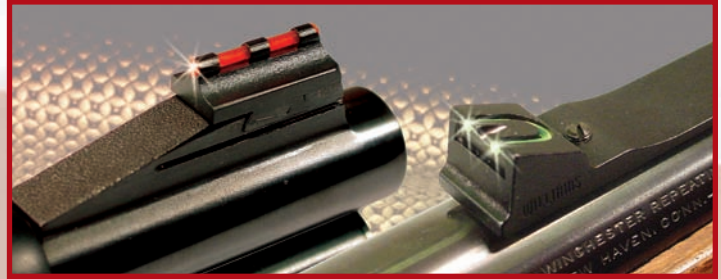

DOVETAIL FIRE SIGHT SET

Fully adjustable rear metallic Fire Sight fits all standard 3/8" dovetails on most Marlin and Winchester models. Front Fire Sight steel bead replaces existing factory bead. Light-gathering fiber optics for most lever action rifles with RAMPED front sights. No gunsmithing required.

ITEM	PRICE
60217 - Dovetail Fire Sight Set	\$35.95
62261 - Rear Sight Only 5/16"	\$19.95
70270 - Marlin 25N & 25MN	\$29.95
NEW! 70742 - Marlin 925, 925M, 60 Blue, 915Y Blue, 983T, 981T, 795 Blue	\$29.95
70239 - Browning BLR	\$37.95

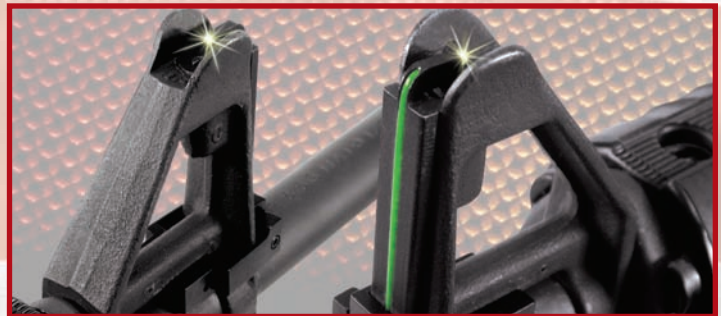

AR-15 STYLE FIRE SIGHT

Front metallic sight that is fully adjustable for elevation. No gunsmithing required.

ITEM	PRICE
70229	\$41.95



WGOS SLIDE/BLADE REPLACEMENT

WGOS Slide/Blade Fire Sight Combination Fits all standard Williams adjustable rear guide open sight bases. Both pieces are made of aircraft strength aluminum (NOT PLASTIC). Turn a classic rear sight into Fire Sights.

ITEM	HEIGHT	PRICE
60218	1/4"	\$23.95
60219	5/16"	\$23.95

MUZZLELOADER FIRE SIGHTS

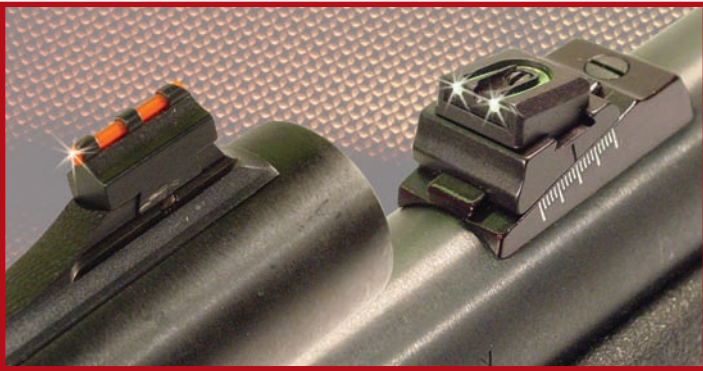

KNIGHT MUZZLELOADER FRONT AND REAR FIRE SIGHT SET

<u>ITEM</u>	<u>PRICE</u>
66369Fits all Knight rifles, includes ramp	\$49.95
66652Rear slide and blade combination with front bead for Knight MK85 models with existing Williams rear sight.	\$37.95

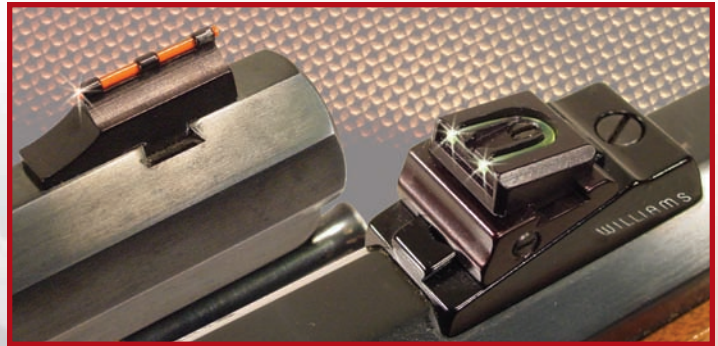

MUZZLELOADER FRONT RAMP AND REAR FIRE SIGHT SET

All new brighter front sight. A must for all Muzzleloader shooters.

<u>ITEM</u>	<u>PRICE</u>
66653CVA's with octagon barrels	\$39.95
66711CVA's with round barrels and dovetail front sight.....	\$39.95
66654Thompson Center with octagon barrels ..	\$39.95
66655Thompson Center New Englander	\$39.95
62260Traditions Lighting Fire, Buckhunter, Timberridge, and Cabela's private label with round barrels	\$39.95
70219Cabela's Octagon Hawken	\$39.95
70245Savage MLII, Winchester X150, CVA's with round barrels & drilled & tapped front sight	\$39.95
70269CVA Optima and Optima Pro, Kodiak ..	\$39.95

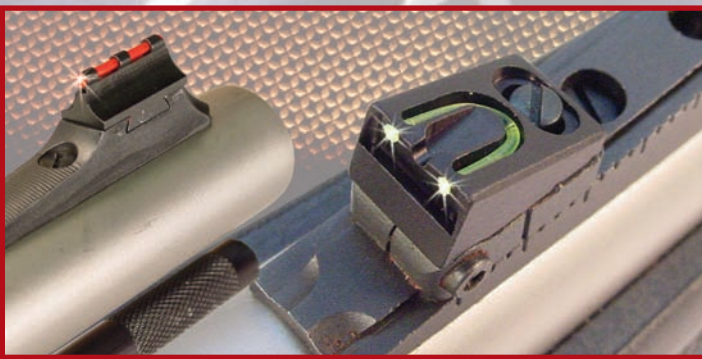

REMINGTON MUZZLELOADER FIRE SIGHT SET

Front and rear Fire Sights replace existing Remington factory rear blade and front bead.

<u>ITEM</u>	<u>PRICE</u>
56530.....Fits pre 2003 rifles, muzzleloaders (all shotguns)	\$29.95
70267Fits post 2003 rifles and muzzleloaders with 1-Pc. Ramp	\$29.95

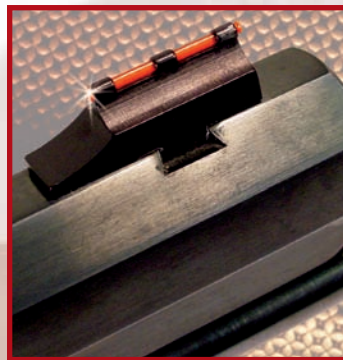

MUZZLELOADER FRONT RAMP FIRE SIGHT

Fits round or octagon barrels with dovetail (overall height including dovetail

<u>OCTAGON</u>	<u>or</u>	<u>ROUND</u>	<u>HEIGHT</u>	<u>PRICE</u>
66656		66660.....	450	\$17.95
66657		66661.....	500	\$17.95
66658		66662.....	550	\$17.95

Note: Installation of dovetailed front sights in ramps and especially dovetailed barrels almost always requires some minor fitting. Gunsmith installation is recommended.

VISIT US ON THE WEB AT:

WWW.WILLIAMSGUNSIGHT.COM

MILITARY SIGHTS

WSKS

**WSKS
APERTURE SIGHT**



The WSKS is available in two versions, to replace the military rear sight on SKS 7.62x39 rifles. No drilling and tapping required. Fully adjustable for elevation and windage.

The WSKS Open Sight comes with a 1/4" U blade.

The WSKS Aperture Sight comes with a special large hole aperture (R 3/8 x .150) for an excellent field of view. Also available as Fire Sight set.

**WSKS
OPEN SIGHT**



**WSKS
FIRE
SIGHT
FRONT**

WAK47

**WAK47
APERTURE SIGHT**



Similar to the Williams WSKS sights the WAK47 is designed for AK47's with the original military type rear sight. Fully adjustable for elevation and windage, no drilling and tapping required.

The WAK47 is available in two styles, WAK47 Open Sight with 1/4" U blade or WAK47 Aperture Sight with R 3/8 x .150 aperture.

**WAK47
OPEN SIGHT**



**WM-96
APERTURE SIGHT**



Designed for economy and easy installation, the WM-96 fits Mauser 96 type military rifles. It installs in place of the military rear sight without drilling and tapping and is compatible with the military front sight. Fully adjustable for windage and elevation. Available in two styles. WM-96 Open Sight with 1/4" U style blade or WM-96 Aperture Sight with R 3/8 x .150 aperture.

**WM-96
OPEN SIGHT**



FP SERIES

RECEIVER SIGHTS

Internal micrometer adjustments have positive internal locks. The FP is strong, rugged, dependable. The alloy used to manufacture this sight has a tensile strength of 85,000 pounds. Yet, the FP is light and compact, weighing only 1-1/2 ounces.

For big game hunting, the FP will outsell all other makes and models of receiver sights put together.

Many rifles are now being drilled and tapped at the factory for installation of the FP.

Target knobs are available on all models of the FP receiver sight if desired.

**VISIT US
ON THE
WEB AT:**

WWW.WILLIAMSGUNSIGHT.COM



FP-GR ON GROOVED RECEIVER

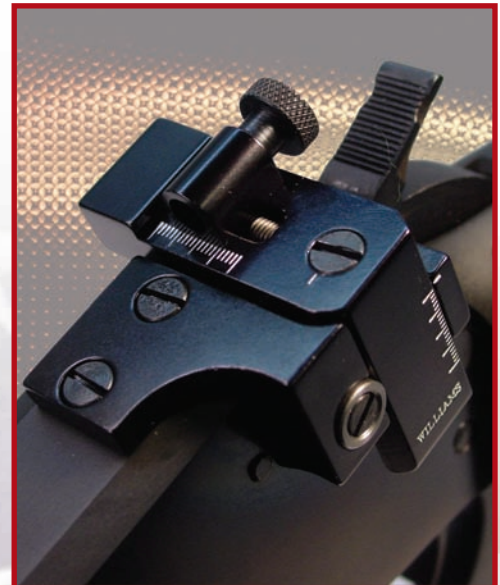

FP-336

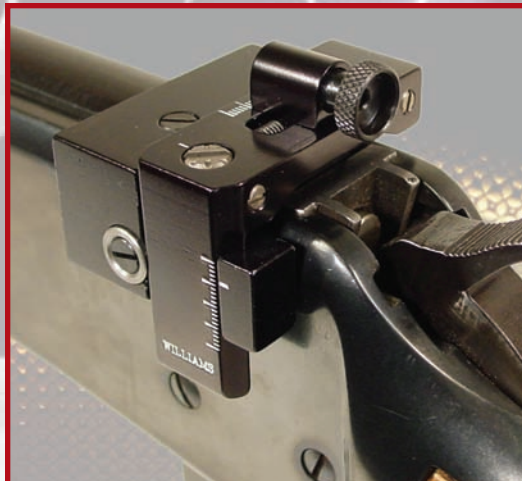

FP-94 SE SHOWN ON WINCHESTER 94 SIDE EJECT



FP-AG-TK ON BEEMAN AIR RIFLE

FP RECEIVER SIGHT OPTIONS. — OPTIONAL APERTURES — SEE PAGE 14



STANDARD



TARGET KNOBS (TK)

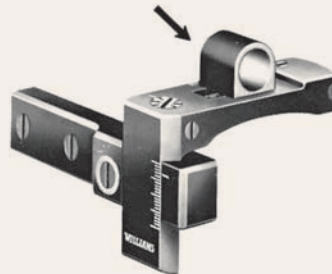

SHOTGUN/
BIG GAME APERTURE



BLADE

FP SERIES RECEIVER SIGHTS

THESE MODELS FIT MORE THAN 100 GUNS

FP-11/87	For Remington 870, 1100 and 11/87. Also Browning BPS and Ruger Mini-14 Ranch Rifle.	FP-788LH	For Remington 788 left hand action.
FP-12/37	For Winchester 12, 1200, 1400, 150, 190, 250, 255, 270, 275 and 290; Ithaca 37; Remington Sportsman 48, 58, 11-48, and most flat receiver pumps and autoloaders.	FP-1885	For Browning 1885 single shot rifle. (No drilling and tapping required.)
FP-14	For Remington 14 and 141.	FP-7400	For Remington 7400, 4, 7600, 6 (no drilling and tapping)
FP-17	For Enfield, Remington Express and British Pattern 14.	FP-A BOLT	For Browning A-bolt (Fits factory drilling and tapping on top of receiver)
FP-30 Car.	For Government 30 Carbine.	FP-AG	For air guns and .22 rifles with dovetail grooved receivers and high line of sights. (No drilling and tapping required.) .450 at lowest adjustment.
FP-39	For Marlin 39A lever action	FP-A3	For 03/A3 and 03 Springfield.
FP-39TM	For Marlin 39A lever action (mounts in front scope mount hole)	FP-BAR	For Browning auto-loading high power rifle.
FP-70	For 70 and 54 Winchesters; 721, 722, 725 Remingtons	FP-FN	For factory drilled and tapped FN and Dumoulin, Mark X.
FP-70AP	For new Model 70, 67 and 770 with high sight line: Remington 700, 700M/L, Mossberg 800 and 3000: BSA: and Howa Model 1500.	FP-GR	For air guns and .22 rifles with dovetail grooved receivers and low line of sights. (No drilling and tapping required.) .350 at lowest adjustment.
FP-71	For Winchester 71, 86, 05, 07, and 10. Also for Model 95 Winchester lever action and Browning centerfire lever action.	FP-Hawken	For Pre 1991 Thompson/Center Hawken and Renegade M/L rifles. This sight fitted with sub-block. Necessary to drill and tap one hole on models that factory discontinued drilling.
FP-88/100	For Winchester 88 lever action; Winchester 100 auto; Marlin 56, 57, 62, 99 autoloading; and Sako Finnwolf.	FP-H&R	Fits Buffalo Classic, Handi rifles.
FP-94/36	For Winchester Models 94 Top eject, 55, 63, 64, 65, and 9422; Marlin Models 36, 336, 444, 44 Magnum, and 93 and 1895 and 1895G pre 2001; Sears centerfire lever action.	FP-JAP	For Jap .25 and .31 caliber rifles.
FP-336	For Marlin centerfire lever actions (uses two rear scope mount holes.) 1894 requires hammer extension.	FP-KNIGHT	For Modern Muzzleloading Knight MK-85 (Fits factory drilling and tapping on top of receiver.)
FP-94/375	For Winchester 94 Big Bore .375. also fits 94 Big Bore Angle Eject, but drilling and tapping is necessary.	FP-Krag	For American Krag and Norwegian Krag.
FP-94SE	For newer Winchester 94 Angle Eject models (fits factory drilling and tapping on top of receiver.)	FP-M9	For Marlin Model 9 and 45 Carbines.
FP-94BBSE	For Winchester "Big Bore" Angle Eject .307 & .356 Win. (Fits factory drilling and tapping on top of receiver.)	FP-Mini-14	(Pre 2005) For all Ruger Mini-14's except Ranch Model
FP-98	For military Mauser, Husqvarna, Weatherby Mark V, right and left, and BRNO without dovetailed receiver.	FP-RSS	For Ruger No.1 and No. 3 single shot rifles. Drilling and tapping required. Hole drilling should be .100 below top of flat portion of receiver to give proper sight alignment.
FP-98AP	For Browning high power bolt with high line of sights; also for Remington 700 left hand.	FP-RU	For 44 Magnum Ruger carbine and .22 L.R. 10/22 /10-22 Mag, 96-22 / 96-22 Mag, 96-44 requires drilling and tapping.
FP-99S	For late Savage 99 with top tang safety. Will fit old 99, but will be necessary to drill and tap.	FP-RU-77	For Ruger Model 77 bolt action.
FP-110	For Savage 110 bolt action, right and left.	FP-SMLE	For British Short Magazine Lee Enfields.
FP-121	For Remington 12 and 121.	FP-SSM	For square sterned auto shotguns. Also fits 8-81 Remington.
FP-340	For 322-325-340-342 Stevens Savage.	FP-SW	For 1911, Swiss .75
FP-600	For Remington 600, 660 bolt action & XP-100. If you specify TK for target knobs, they are furnished for elevation only (not for windage).	FP-T/C	For Thompson/Center Contender Pistol and Carbine.
FP-740AP	For all 742 Remingtons and for the late 760-740 Remingtons with high comb (all purpose stock) and high iron sights. Also for the higher sight models of the 740 in the 30-06 and 280 calibers above serial number 207,200, and the 308 caliber above serial number 200,000. also for Remington 572BDL and 552BDL and Savage 170.	FP-T/C ENCORE/OMEGA	For Thompson/Center Encore, Omega, G2, Scout. (Fits factory drilling and tapping on top of receiver) Requires higher, 570W front sight.
FP-788	For Remington 788 bolt action if factory drilled and tapped. New models not drilled and tapped use FP-70AP.	FP-WHITETAIL	For White Systems Whitetail (Fits factory drilling and tapping top of receiver.)
		FP-LEGEND	For Modern Muzzleloading Knight Legend, Wolverine, Disc, Bighorn, American, and T-Bolt (Fits factory drilling and tapping.)
		FP-77/50	For Ruger Model 77 Muzzleloader

NOTE: ADD 'TK' TO MODEL NUMBER IF TARGET KNOBS ARE DESIRED
SEE PRICE LIST FOR COMPLETE LISTING
OF ALL AVAILABLE MODEL VARIATIONS

5D SERIES

RECEIVER SIGHTS

- **For Big Game Rifles, 22's, Shotguns**
- **Positive Windage and Elevation Locks**
- **Lightweight, Strong, Accurate**
- **Williams Quality Throughout**
- **Rustproof**

Available for most of the more popular rifles and shotguns – the inexpensive, quality-made 5D sight. These sights are patterned after the Foolproof. They have the same strength, lightweight, and neat appearance, but without the micrometer adjustments. Designed for rugged hunting use, the 5D sights are dependable and accurate. Positive locks. Clear unobstructed vision. No knobs or side plates to blot out shooter's field of vision.

Wherever possible, the manufacturers' mounting screw holes in the receivers of the guns have been utilized for easy installation. The upper staff of the Williams 5D sight is readily detachable. It is only necessary to loosen one screw so that the upper staff slides easily in the close-fitting dovetail. The angular bushing locks this upper staff in a positive manner. A set screw is provided as a stop screw so that the sight will return to absolute zero upon detaching and reattaching.

The material used in the manufacture of the Williams 5D sight is one of the highest grade alloys obtainable. There has been no sacrifice of quality as we are using one of the most expensive, highest tensile strength alloys that money can buy.

Laboratory tests show that the material used has a tensile strength approximately 25% greater than mild steels.

This high-grade alloy is finished with an anodize in a deep blue-black that adds even further to the strength of the sight by creating an extra hard surface.

Note two positions for aperture holder to give double the amount of windage.

Standard thread sizes, the same as used on the Foolproof, permit the use of a wide range of apertures for all sighting conditions. Twilight apertures interchangeable.



5D-336



5D-94/36

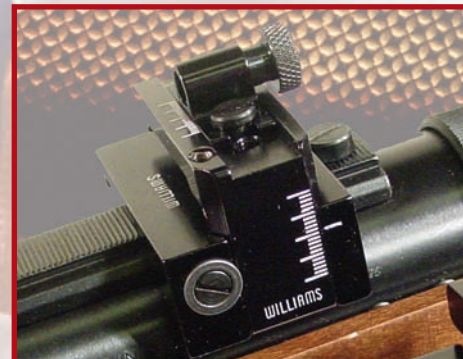

5D-AG

5D-12-37* Winchester 1200, 1400, 12-25, 150, 190, 250, 255, 270, 275, and 290; Remington 1100, '58, 11-48, Spt's. 48; 870, and 31; Stevens 620; Ithaca 37; and other shotguns with flat-sided receivers.

5D-22/410 For the .22-410, 20, etc. over and under Savage or Stevens.

5D-39A Marlin 39A lever action. No drilling or tapping necessary.

NEW 5D-39TM For Marlin 39A (mounts in front scope mount hole).

5D-70 For Winchester 70, 54, 670, 770, and 74 .22 Auto; Remington 700, 721, 722, and 725; Mossberg 800 and 3000; and Howa Model 1500.

5D-81 For Marlin 80,81 and A1 rifles (factory drilled and tapped.)

5D-94/36 For Winchester 94 Top eject, 64, 9422; Marlin 36, 336, 1894, .44 Magnum (Pre 2001)

5D-336 For Marlin Centerfire Lever actions (uses two rear scope mount holes) 1894 requires hammer extension.

5D-510 For Remington 510, 511, 512, 513, and 521T (some factory drilled and tapped), Nylon 12 tubular loading, Nylon 11 box magazine

5D-94SE For Winchester 94 Angle Eject (Except Big Bore Model) Fits factory drilling & tapping on top of receiver

5D-760N-740-742 For the Remington 760 with serial numbers above 154,965 and 740's above serial number 64,046. also for Remington Nylon 66 and Models Four, Six, 7400, and 7600; Winchester new series 250, 255, 270, 275, and 290 with ramp; and Savage 170, and Remington 572, 572BDL,552BDL .22 slide action; Kodiak 260.

5D-AG For air guns and .22 rifles with dovetail grooved receivers and high line of sights (no drilling and tapping required)

5D-GR For air guns and .22 rifles with dovetail grooved receivers and low line of sights (no drilling and tapping required)

5D-JEMS For Jap, Enfield, Mauser and Springfield 03; Remington 700 L.H.; Daisy 99 and 299

5D-KRAG For American Krag

5D-03/A3 For 1903-A3 Springfield.

5D-RU For 44 Ruger Carbine & 10/22 (all models.) Including 10-22 Mag

5D-SH For Sheridan Model 'C'; Benjamin 340, 342, 347. (The Benjamin needs a higher front sight.)

5D-SMLE For British Shot Magazine Lee Enfield, Nos. 1, 4, & 5.

5D-SSM* For square stern models of Remington, Browning, and Savage auto shotguns. Also fits Remington 8-81 autoloaders.

*** Special shotgun aperture optional. 3/8" O.D. Aperture with .093 inner hole furnished unless otherwise specified. **Subject to stock on hand.**

Some of the Higgins guns are made by Marlin. Usually if the model number 103 is on a Higgins gun—then it's made by Marlin. consequently, some of the sights we have designed for Marlin will fit a few models of the Higgins.

WGRS SERIES

RECEIVER SIGHTS

- **Compact Low Profile**
- **Lightweight, Strong, Rustproof**
- **Positive Windage and Elevation Locks**

In most cases these sights utilize dovetail or existing screws on top of the receiver for installation. They are made from an aluminum alloy that is stronger than many steels. Light. Rustproof. Williams quality throughout.

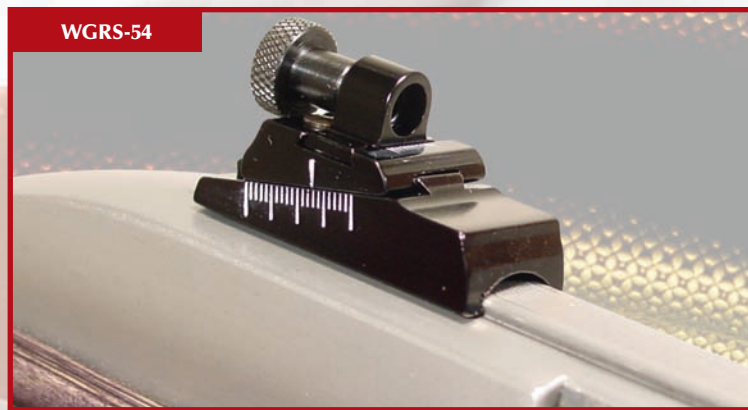

OPEN SIGHT BLADES FOR THE GUIDE RECEIVER SIGHT:

The WGRS receiver sight can be converted to an open sight by installing a 1/4" WGOS blade in place of the aperture holder.



"GHOST RING"

Shotgun aperture available for WGRS receiver sights. Sold separately.



WGRS-37—For Ithaca 37 pump shotgun, Browning BPS and Maverick 88.

WGRS-44—For Ruger 44, Similar to the WGRS-RU22, but not interchangeable. Usually requires a higher front sight — .500 to .570M

WGRS-54—For Savage-Anschutz 54, 64, 141, 141M, 153, 153S; Remington 541S; Winchester 310, 320, 9422. (On 9422, a front sight height of .450 is required.) This is a very versatile sight in that it can be fitted on most of the dovetails on the receivers of .22 rifles. These dovetails have quite a wide tolerance and in many cases will require some hand fitting of the WGRS-54, but this can be easily accomplished by filing the bottom of the sight slightly to increase the width of the dovetail and then it is just a matter of slipping the sight on. Because of low line sights a higher front sight may be required. Use of the Williams Shorty, or Streamlined ramp and a Williams beaded front sight should solve any of these problems.

WGRS-70—For all post war Model 70 Winchesters. Will also fit the Model 670 and 770. Also, Browning A-Bolt.

WGRS-LEGEND—For Modern Muzzleloading Legend, Wolverine. Fits factory drilling and tapping.

WGRS-DISC - T-Bolt—For Knight Disc and T-Bolt

WGRS-ENCORE—For T/C Encore and T/C Omega

WGRS-BLACK DIAMOND—For T/C Black Diamond

WGRS-Moss 695—For Mossberg 695

WGRS-100—For Winchester 88 lever action and 100 automatic. (Higher front sight needed—.450 height.) Also for Sako Finnwolf.

WGRS-700—For Remington 700, 721 and 722. Also for Howa 1500.

WGRS-742—For Remington 760 and 742. Early models will require a higher front sight. For the BDL's, use the FP-740AP.

WGRS-7400—For Remington models 4, 7400, 6, and 7600.

NEW! WGRS—Remington 870 fits Remington factory drilled and tapped shotguns (Post 2005)

WGRS-BAR—For Browning BAR Auto rifle and BLR lever action. (BAR uses 9/16 ramp + .375N bead)

WGRS-FN—Will fit any FN type action with 1/2" hole spacing, including the Mauser FN, S&W, Crown Grade Husqvarna (CGH), and the Browning high power bolt action, and Mark X.

WGRS-H&R—For H&R 158, 258 Topper single shot rifles. Also fits other 1/2" radius barrels or receivers and has 1" hole spacing. Fits Ruger MK-II .22 auto pistol receiver (drilling & tapping required). H&R Buffalo classic use .570W front sight.

WGRS-WN—For Winchester 1300 and 1400 Slug Hunter. Fits factory drilling and tapping.

WGRS-M1 CAR.—For the 30 M1 Carbine. Fits dovetail.

WGRS-99-44 Ruger—Set with proper Fire Sight, front sight and riser block (non drill and tap).

WGRS-336 Set—For Marlin 336 with proper fire sight, front sight (non drill and tap).

WGRS-96-22 Set—For Ruger 96-22, 96-22 Mag with proper Fire Sight, front sight (non drill and tap).

WGRS-M/L—For large octagon barrels. Has flat base. (Also see WGRS-CVA)

WGRS-MINI-14/30—Fits Ruger Mini-14 Ranch rifle and Mini-Thirty. (Pre 2005)

WGRS-RU-22—Fits Ruger 10/22 without drilling or tapping. A higher front sight is normally required usually .570. Also, Winchester 1300 and 1400 Slug Hunter.

WGRS-RU-22—Set with WGB-570M 1/16"

WGRS-RU-22—Set with Fire Sight front

WGRS-T/C—For Thompson/Center Contender pistol, G2

WGRS-WR—For late Winchester and Remington slide action and auto-loading shotguns. Also will fit Hopkins & Allen muzzleloaders.

WGRS-KN—For Modern Muzzleloading Model MK-85 Knight rifle, and Savage M-110 with flat receiver.

WGRS-SAVAGE—For Savage 110 with round receiver. (needs 538M bead)

WGRS-Optima Set—Fits Optima and Optima Pro, includes Fire Sight Front. **Order Item No. 70271**

WGRS-CVA Round—For CVA rifles with round barrel, Winchester X-150 Muzzleloaders.

WGRS-CVA—For CVA rifles with octagon barrel or receiver design. (Apollo, etc.) Many are factory drilled and tapped. Also fits Traditions Deerhunter. Requires higher front sight. By drilling and tapping, this sight can be used on most 15/16 & 1" octagon barrels.

WGRS-WHITETAIL—For White Systems Whitetail Muzzleloader. (Fits factory drilling and tapping.)

RECEIVER SIGHTS AND APERTURES

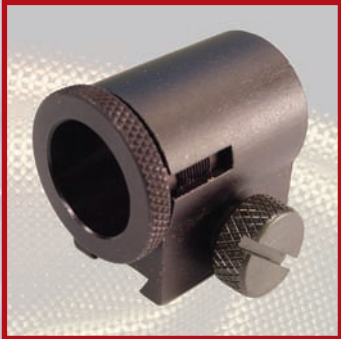

Target Globe Front Sight

(Less attaching base)

The Williams Target Globe Front Sight is adaptable to many different rifles for target competition shooting. It comes complete with a

selection of inserts. It mounts easily to the attaching base with a knurled locking screw. Height of the target globe sight is .545 from center, not including the attaching base.

Attaching bases for target globe front sight:

DOVETAIL (LOW).....	HEIGHT .220
DOVETAIL (HIGH).....	HEIGHT .465
SCREW ON	HEIGHT .300, RADIUS .300
SCREW ON	HEIGHT .450, RADIUS .350
SCREW ON	HEIGHT .215, RADIUS .400

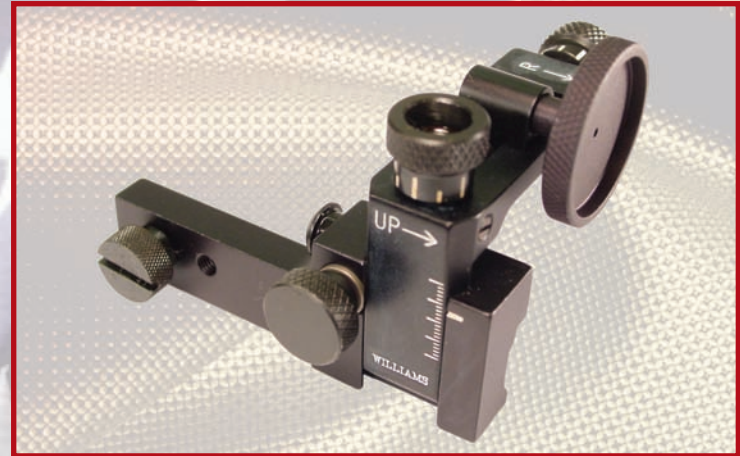

"DELUXE" Target FP-High (Less attaching base)

Similar to the regular Williams Target FP-High the new "Deluxe" model has the following added features:

Two mounting positions for more precise eye relief.

Special knurled elevation locking screw.

Improved target adjustment screws with "white line" reference markings.

Push button release for quick removal of top portion of sight and a support set screw for easy return to original position.

See page 15 of catalog for available attaching bases.

APERTURES



TWILIGHT

TWILIGHT SERIES

Twilight apertures are designed for shooting under poor light conditions, early morning, late evening, and other inclement conditions. They create a sharp contrast that gives quick definition to the aperture hole, and they eliminate the "fuzz" with which many shooters have trouble.



TARGET

These apertures are perhaps the greatest development in metallic sights in the last three decades – positive sighting when the light is poor but the hunting best.

Williams 'Twilight' apertures will accommodate Redfield, Lyman, etc.



REGULAR

- TW-3/8 x .050*3/8" O.D. with .050 inner hole
- TW-3/8 x .093*3/8" O.D. with .093 inner hole
- TW-3/8 x .125*3/8" O.D. with .125 inner hole
- TW-3/8 x .150*3/8" O.D. with .150 inner hole
- TW-1/2 x .050.....1/2" O.D. with .050 inner hole
- TW-1/2 x .093.....1/2" O.D. with .093 inner hole
- TW-1/2 x .125.....1/2" O.D. with .125 inner hole

*Available with long shank for WGRS Receiver Sights



**FP
BIG GAME**

SHOTGUN BIG GAME

All Williams FP and 5D receiver sights can be equipped with the shotgun aperture. This aperture has amazing light gathering ability. Permits clear shooting even when the light is poor. Designed for aerial shooting, slug shooting and for big game rifles.

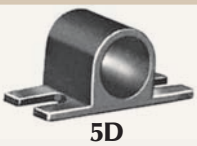

**5D
BIG GAME**

REGULAR SERIES

Buckbuster – Standard – Target

We have always felt that a disc with a small outer diameter and a large inner hole is best for hunting. For this reason, we have made the 3/8" O.D. disc with a .093 inner hole as standard equipment. Other sizes are optional.

For the shooter who wants the FASTEST sighting aperture, we can supply our BUCKBUSTER model which has a 3/8" O.D. and a large .125 inner hole. Williams discs are standard thread size and will accommodate Redfield, Lyman, etc.

R-3/8 x .050*3/8" O.D. with .050 inner hole
R-3/8 x .093*3/8" O.D. with .093 inner hole
(STANDARD)

R-3/8 x .125*3/8" O.D. with .125 inner hole
(BUCKBUSTER)

R-3/8 x .150*3/8" O.D. with .150 inner hole

R-1/2 x .0501/2" O.D. with .050 inner hole

R-1/2 x .0931/2" O.D. with .093 inner hole

R-1/2 x .1251/2" O.D. with .125 inner hole

R-1" x .0501" O.D. with .050 inner hole
(TARGET)

PROVIDES THE FASTEST, MOST ACCURATE SIGHTING YOU CAN HAVE!

NOTE: Long shank apertures for WGRS Receiver Sight are available only in the 3/8 x .093, 3/8 x .050, 3/8 x .125 and 3/8 x .150 sizes.



**FP-SQUARE
NOTCH BLADE**

TARGET FP SERIES

To meet the increased demand for a high quality receiver sight for target rifles at a reasonable price, Williams developed the TARGET – FP receiver sight series.

Available in High or Low sight line models, the TARGET – FP receiver sight with proper attaching base can be adapted to most .22 caliber target rifles as well as many sporter type rifles.

In most cases the TARGET – FP (high) receiver sight is recommended on target type rifles with globe front sights. The TARGET – FP (low) is for sporter type rifles and is compatible with standard front sights (some guns may require higher front beads) or the lowest globe type front sights.

Because of the versatility of the TARGET – FP receiver sight series, most popular rimfire bolt action rifles can be equipped with target sights. As demand grows, additional models of attaching bases will be made available. See the attaching base selection chart for models currently offered.

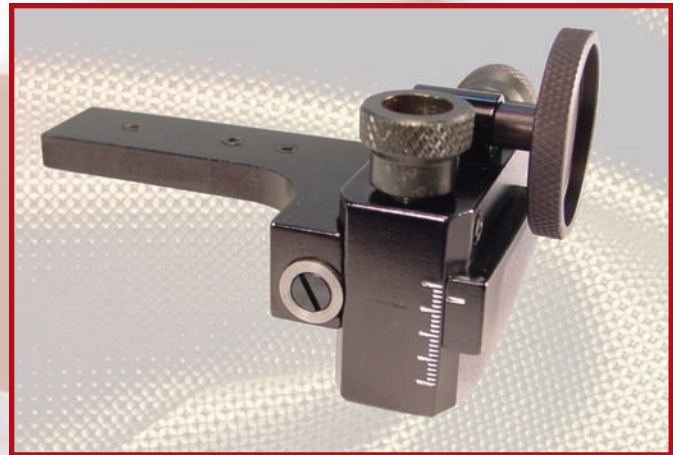

TARGET FP-ANSCHUTZ
Designed to fit many of the Anschutz
Lightweight .22 Cal. Target and Sporter Models.
No Drilling and Tapping required.



TARGET – FP (High)
Adjustable From 1.250" to 1.750"
Above Centerline of Bore.

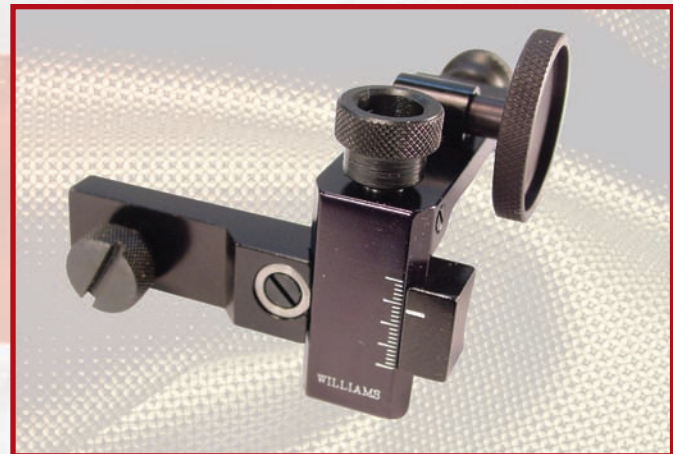

TARGET – FP (Low)
Adjustable From .750" to 1.250"
Above Centerline of Bore.



ATTACHING BASE SELECTION CHART FOR TARGET – FP



BASE

MODELMODEL OF GUN

No. 540Fits Remington Models 540X,
541-S, 580*, 581*, 582*

No. 510Fits Remington Models 510*, 511*,
512*, 513-T, 521-T

No. 75Fits Winchester Model 75

No. 64Fits Savage/Anschutz Model 64*
and Mark 12*

*Drilling and Tapping Required.

OPEN SIGHTS

WGOS Series

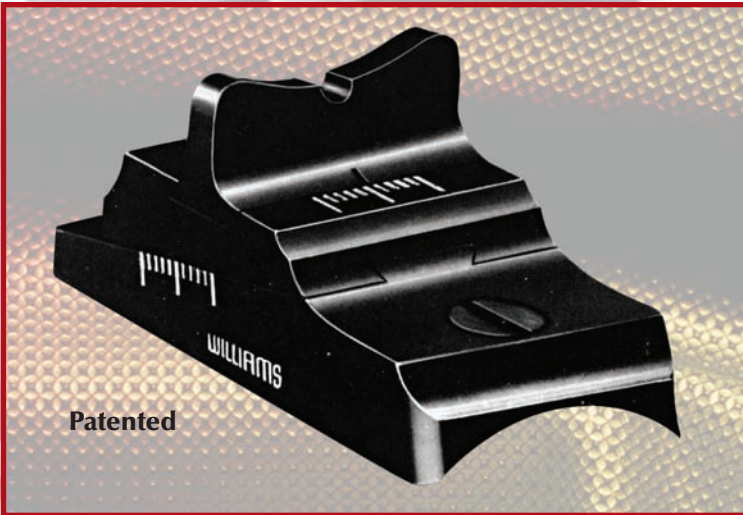

- Made from high tensile strength Aluminum. Will not rust.
- All parts milled – no stampings.
- Streamlined and lightweight with tough anodized finish.
- Dovetailed windage and elevation – Easy to adjust, positive locks.
- Interchangeable blades available in four heights and four styles.

WGOS SPECIFICATION CHART

SIZE	RADIUS	HOLE SPACING (center to center)	FITS
Flat	—	.5625	Large octagon barrels, etc.
Small	.347	.5625	Bbl. Dia. .660-.730
Medium	.395	.5625	Bbl. Dia. .730-.830
Special*	.395	.5625	Bbl. Dia. .730-.830
Large	.440	.5625	Bbl. Dia. .830-.930
X-Large	.475	.5625	Bbl. Dia. .900-1.000
26 MM	.550	.5625	Bbl. Dia. 1.000-1.100
One Inch	.500	1.000	Bbl. Dia. 1.000
Octagon-T/C	—	.835	Octagon Bbl. 15/16" & 1" Dia.
Octagon-CVA	—	Attaches with one screw to Dovetail Lock	Octagon Bbl. 15/16" & 1" Dia. With Dovetail cut for rear sight
Round-T/C	.5125	.835	Bbl. Dia 1.025

*SAME AS MEDIUM EXCEPT .100 HIGHER

WGOS HEIGHT WITH BLADE (EXCEPT OCTAGON)

ADJUSTABLE

With 3/16" blade	320-.420
With 1/4" blade	382-.482
With 5/16" blade	445-.545
With 3/8" blade	507-.607

When using the WGOS Special add .100 to above heights
 When using the WGOS Flat add .050 to above heights

WGOS OCTAGON T/C AND CVA HEIGHT WITH BLADE

ADJUSTABLE

With 3/16" blade	350-.450
With 1/4" blade	412-.512
With 5/16" blade	475-.575
With 3/8" blade	537-.637

Use 1/4" blade with WGOS Octagon-T/C and CVA to match factory front sight on most T/C & CVA rifles

Blades are sold separately, except "U" blades are available installed on WGOS octagon T/C and CVA. See price list.



SHORTY RAMPS

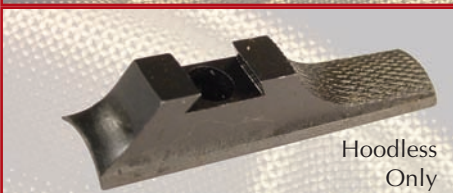
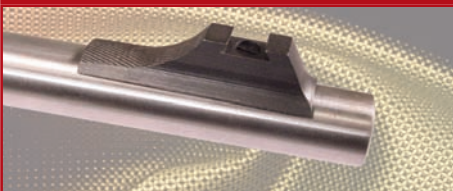

A shortened version of the popular streamlined ramp. It is easily installed. It can be screwed on, sweated on, or installed with an optional dovetail lock that fits into standard 3/8" dovetails.

Available in 1/8", 3/16", 9/32" and 3/8" heights.

WDOS DOVETAIL OPEN SIGHT



Lightweight high strength alloy. Steel screws and locks. Fits standard 3/8" dovetail. Anodized black finish. Rustproof. The revolutionary design of the WDOS means no more driving or hammering an open sight into the dovetail of the rifle. It simply slides into the dovetail slot in the barrel with finger tip pressure. As you tighten the locking screw it snugs the dovetail on the rifle barrel and locks the sight in place. Available in four heights with four different styles of blades – the same blades as used in the famous Williams Guide Open Sight – the U, V, SQ, and Britisher type notches.

The WDOS with 3/16" blade is adjustable in height from .281 to .345.

The WDOS with 1/4" blade is adjustable in height from .345 to .406.

The WDOS with 5/16" blade is adjustable in height from .406 to .468.

The WDOS with 3/8" blade is adjustable in height from .468 to .531.

RISER BLOCKS

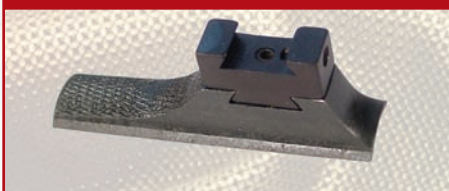

Adds .250 to the height of dovetail. Especially handy on models that require higher than normal front sight (when installing a receiver sight). Available in two widths –.250 for Williams Streamlined ramps or ramps with a 1/4" top width – and the .340 on all standard ramps (Winchester, Remington, Savage, etc.) having this base width. Incorporates standard 3/8" dovetail.

SHOTGUN SHORTY RAMPS

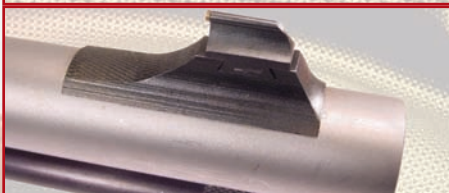
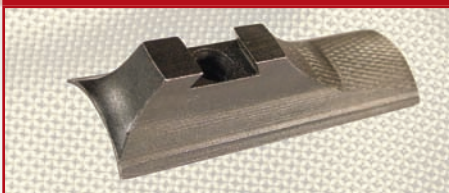

Now available for the two most common 12 ga. barrel diameters (.875 and .815) and also for 20 ga. barrel diameter (.690).

Available in 1/8", 3/16", 9/32" and 3/8" heights.

OPEN SIGHTS

STREAMLINED FRONT SIGHTS



The Williams Streamlined Front Sights are available in three widths, and a variety of heights, with industry standard 3/8" dovetail.

The narrow (N) .250 width is for Williams Streamlined and Shorty ramps.

The medium (M) .340 width is for factory ramps such as Marlin, Remington, etc...

The wide (W) .531 width is for dovetailed barrels commonly found on .22 rifles and muzzleloaders.

BEAD DIAMETER

WGB 1/16" or 3/32"	Gold	.250N
WGB 1/16" or 3/32"	Gold	.290N
WGB 1/16" or 3/32"	Gold	.312N
WGB 1/16" or 3/32"	Gold	.343N
WGB 1/16" or 3/32"	Gold	.375N
WGB 1/16" or 3/32"	Gold	.406N
WGB 1/16" or 3/32"	Gold	.450N

BEAD DIAMETER

WGB 1/16" or 3/32"	Gold	.250M
WGB 1/16" or 3/32"	Gold	.290M
WGB 1/16" or 3/32"	Gold	.312M
WGB 1/16" or 3/32"	Gold	.343M
WGB 1/16" or 3/32"	Gold	.375M
WGB 1/16" or 3/32"	Gold	.406M
WGB 1/16" or 3/32"	Gold	.450M

MODELS FOR WIDE (W) WIDTHS

WWGB 1/16"	Gold	.343W
WWGB 1/16"	Gold	.375W
WWGB 1/16"	Gold	.410W
WWGB 1/16"	Gold	.450W
WWGB 1/16"	Gold	.500W
WWGB 1/16"	Gold	.538W
WWGB 1/16"	Gold	.570W

SPECIAL HEIGHTS: .538M, .570M

Note: Installation of dovetailed front sights in ramps and especially dovetailed barrels almost always requires some minor fitting. Gunsmith installation is recommended.

OPEN SIGHTS

SIGHT COMBINATION CHART

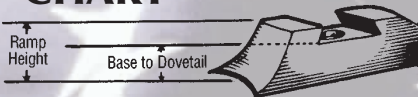

Ramp Height	Height from Base to Dovetail	Height of Williams Bead	From Top of Barrel to Top of Bead
1/8"	.035	.250	.285
1/8"	.035	.290	.325
1/8"	.035	.312	.347
3/16"	.0975	.250	.3475
1/8"	.035	.343	.378
3/16"	.0975	.290	.3875
3/16"	.0975	.312	.4095
1/8"	.035	.375	.410
3/16"	.0975	.343	.4405
1/8"	.035	.406	.441
9/32"	.191	.250	.441
9/32"	.191	.290	.481
3/16"	.0975	.375	.4725
5/16"	.2225	.250	.4725
1/8"	.035	.450	.485
9/32"	.191	.312	.503
3/16"	.0975	.406	.5035
5/16"	.2225	.290	.5125
9/32"	.191	.343	.534
5/16"	.2225	.312	.5345
3/8"	.285	.250	.535
3/16"	.0975	.450	.5475
5/16"	.2225	.343	.5655
9/32"	.191	.375	.566
3/8"	.285	.290	.575
9/32"	.191	.406	.597
3/8"	.285	.312	.597
5/16"	.2225	.375	.5975
7/16"	.3475	.250	.5975
3/8"	.285	.343	.628
5/16"	.2225	.406	.6285
7/16"	.3475	.290	.6375
9/32"	.191	.450	.641
7/16"	.3475	.312	.6595
3/8"	.285	.375	.660
5/16"	.2225	.450	.6725
7/16"	.3475	.343	.6905
3/8"	.285	.406	.691
3/8"	.285	.450	.735
7/16"	.3475	.375	.7225
9/16"	.4725	.250	.7225
7/16"	.3475	.406	.7535
9/16"	.4725	.290	.7625
9/16"	.4725	.312	.7845
7/16"	.3475	.450	.7975
9/16"	.4725	.343	.8155
9/16"	.4725	.375	.8475
9/16"	.4725	.406	.8785
9/16"	.4725	.450	.9225



Streamlined

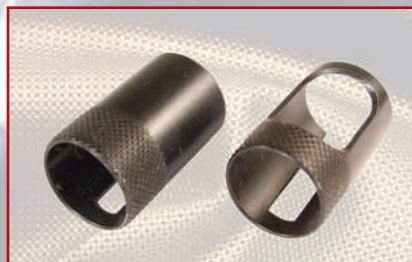
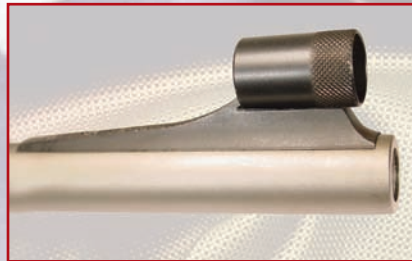

STREAMLINED RAMPS

The Williams Streamlined Ramps have a 3/8" dovetail and pleasing lines not found in any other ramp. The ramp is beautifully blued. 6-48 screws furnished. Available in heights of: 9/16", 7/16", 3/8", 5/16", 3/16". Specify "Screw On" or "Sweat On."

A special Streamlined "Screw-On" Ramp is available to match factory ramp hole spacing (.605) for most Remington Pumps, Autos and Bolt Action Rifles.

Be sure to specify "For Remington Hole Spacing" when ordering.

Available in same heights as regular "Screw-On" Ramps.

Note: The 3/16" "Screw-On" ramp has 1.625" hole spacing.

All other "Screw-On" ramps have 2" hole spacing. Front sights should be ordered in (N) width.

OPEN SIGHT BASE

For late Remington 760, 740, 725, etc. Also can be used on military rifles. Same hole span as the Guide Open Sight. To fit factory drilling and tapping 9/16" or .5625 between mounting screws (center to center). Standard 6-48 mounting screws furnished.

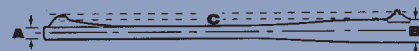

FRONT AND REAR HEIGHT RELATIONSHIPS EXPLAINED

Step by step procedure for selecting open sights for tapered rifle barrels.

STEP ONE: Measure diameter of barrel at Point "A" where front sight is to be installed. (Example: .660 Dia.). Then divide this diameter in half to determine height from center of bore to top of barrel. (Example: $.660 \div 2 = .330$).

STEP TWO: Measure diameter of barrel at Point "B" where rear sight is to be installed. (Example: .820 Dia.). Then divide this diameter in half to determine height from center of bore to top of barrel. (Example: $.820 \div 2 = .410$).

STEP THREE: Select rear sight to be used and add its height to the height determined in Step Two. (In this case we have selected the WGOS with 3/8" blade rear sight which is .560 high at its center of elevation adjustment). This gives you the total height of the rear open sight from the center of the bore. (Example: $.410 + .560 = .970$).

STEP FOUR: You now subtract the height from the center of the bore to the top of the barrel determined in Step One (.330) from

the total height of the rear sight determined in Step Three. (Example: $.970 - .330 = .640$). This tells you that you need a front sight ramp and bead combination approximately .640 high to accommodate the rear sight.

STEP FIVE: Using the Williams Sight Combination Chart you select a ramp and bead coming closest to your height needed as determined in Step Four (.640) which in this case would be the 7/16" ramp with .290N bead giving a height of .6375 as shown on the Chart.

By following these procedures, sight combinations can quickly and easily be determined. When selecting ramp and bead combinations from the Chart, the height need not be exact as there is ample elevation adjustment in the WGOS open sight to compensate for slight variances. Point "C" in the above drawing shows the proper line of sight parallel to the center of the bore when the proper combination is used. When ordering sights and you are still in doubt as to the proper combination please include the dimensions of your barrel at points "A" and "B" so we may assist you in the proper selection.

UNIVERSAL MUZZLELOADER SCOPE MOUNTS

E-Z ON...E-Z OFF (for cleaning) Returns to Zero!!

**WHY STOCK 10-15
DIFFERENT MOUNTS
WHEN 1 MOUNT
WILL DO?**

**GREAT "BACK-UP"
SELLING MOUNT
WHEN OUT OF
OTHER BRANDS**

Universal Mount Fits:

THOMPSON CENTER

**Omega
*Encore**

KNIGHT

**Disc
American
Wolverine
Big Horn
T-Bolt**

CVA

**All round or octagon
muzzleloaders**

TRADITIONS

**All round or octagon
muzzleloaders**

LOW MOUNTS



SIGHT THRU MOUNTS



AVAILABLE IN BLUE OR SILVER

**SEE PRICE LIST FOR CODE NUMBERS
AND PRICES**

***Excludes Encore with Leupold scopes**

SIGHT THRU SCOPE MOUNTS

Shown on Remington Model 7400



**New!
Wider
Design**

- One-Piece Construction
- Large Field of View for Iron Sights Right Under the Scope
- Available for a Wide Assortment of Factory Drilled Rifles
- All Parts are Precision Machined
- Lightweight
- Hard Black Anodized Finish
- Fast Accurate Sighting under All Field Conditions



REMINGTON	SET	
	Front	Rear
Models:		
740, 742, 760 and 870*	A	B
700, 721, 722, 725, and Seven	D	E
7400, Four, 7600, and Six	R	S
WINCHESTER		
70, 670, and 770	D	C
88, 100, and 1300/1400 Slug Hunter	W	W
94 Angle Eject	V	K**
MARLIN		
336, 1894, 1895, 444, 30AS, 9 and 45	H	H
BROWNING		
A-Bolt	C	C
BAR and 81 BLR	G	G
SAVAGE		
110, 111, 112, and 116 with flat receiver	D	F
99 (New Style)	J	K**
110 with round receiver	A	A
RUGER		
10/22	L	M
44	O	M
MOSSBERG		
500 slugster, 835*, Maverick 88*, Pre 1997, 695	J	J
500 slugster, 835, 1997 and after	Y	Y
MUZZLELOADERS		
Knight MK-85 and BK-92	F	F
Knight Wolverine, Legend, Disc, Bighorn, American, and T-Bolt	O	O
Traditions In-Line	R	R
CVA Apollo and Traditions Deer Hunter	T	T
T/C Hawken* and Renegade* (also any other Octagon Barrels that require Drilling and Tapping)	U	U
T/C Black Diamond	Z	Z
OTHERS		
Weatherby MK-V, Vanguard and Howa 1500	D	E
FN Mauser, Browning Safari Bolt, and Mark X	D	I

*Requires Drilling and Tapping **Includes sub-block

The Williams Sight-Thru Mount provides instant use of scope, above, or iron sights below. Easily installed. Uses existing holes on top of receiver. No drilling or tapping necessary. The Sight-Thru is compact and lightweight – will not alter balance of the rifle. The high tensile strength alloy will never rust. All parts are precision machined. Completely rigid and Shockproof. The attractive streamlined appearance is further enhanced by a beautiful, hard black anodized finish.

**SEE PRICE LIST FOR
MOUNTS AVAILABLE IN
"SILVER" ANODIZED
FINISH FOR STAINLESS
STEEL RIFLES.**

SCOPE MOUNTS

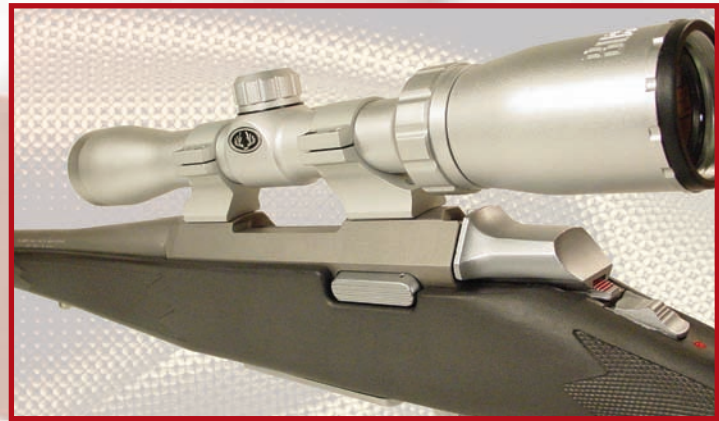

Streamline Top Mount

- Available for Wide Assortment of Factory Drilled Rifles
- Precision Machined – Lightweight
- Solid Construction
- Eliminates Need for Extension Rings – Allows Use of Virtually All 1" Scopes up to 42mm
- The Bases are the Rings
- Hard Black Anodized Finish

The Williams "Streamline" top mount is a revolutionary concept in two-piece mount design. It's solid ring-base construction allows the strongest possible installation of scope to rifle. Because the bases are the rings, there can be no movement between the rings and bases as on other two piece mounts.

By design, the "Streamline" mount eliminates the need for extension rings as the mounts can be reversed allowing for installation of virtually all 1" scopes.

Simplicity of installation – solid construction – and versatility make it the most unique and most rigid two-piece mount on the market.

SEE PRICE LIST FOR MOUNTS AVAILABLE IN "SILVER" ANODIZED FINISH FOR STAINLESS STEEL RIFLES.

Models:

REMINGTON	740, 742, 760 and 870*	1	2
	700, 721, 722, 725, 40X and Seven	4 ***	5
	7400, Four, 7600, and Six	17	18
	541, 580*, 581 and 582*	11	11

WINCHESTER

	70, 670, and 770	4 ***	3
	88, 100, and 1300/1400 Slug Hunter	6	6
	94 Angle Eject	21	22**

MARLIN

	336, 1894, 1895, 444, 30AS, 9 and 45	8	8
--	--	---	---

BROWNING

	A-Bolt	3	3
	BAR and 81 BLR	7	7

SAVAGE

	110, 111, 112, and 116 with flat receiver	4 ***	16
	99	19	20**
	110 with round receiver	1	1

RUGER

	10/22	13	12
	44	11	12

MOSSBERG

	500 slugster, 835*, Maverick 88*, 1997, 695	7	7
	500 slugster, 835, 1997 and after	25	25

MUZZLELOADERS

	Knight MK-85 and BK-92	16	16
	Knight Wolverine, Legend, Disc, Bighorn, American, and T-Bolt	11	11
	Traditions In-Line	24	24
	T/C Black Diamond	26	26
	CVA Apollo and Traditions Deer Hunter	23	23
	T/C Hawken* and Renegade* (also any other Octagon Barrels that require Drilling and Tapping - Installs scope slightly to left to avoid hammer bending)	10**	10**

OTHERS

	Weatherby MK-V, Vanguard and Howa 1500	4 ***	5
	FN Mauser, Browning Safari Bolt, and Mark X	14	15

*Requires Drilling and Tapping

**Includes sub-block

***The Number 4 mount is available in a "Long" version for use with short scopes on long actions. Specify when ordering. (See price list)

SIDE MOUNTS

Quick Convertible Side Mount:

The Williams QC Side Mount permits the shooter to have both scope and iron sight always available for instant use. From the same base, shooter has his choice of rings that place scope directly over the bore or in the offset position. These sighting combinations are becoming more and more popular every day with shooters all over the world.

Williams Side Mounts have positive locks. Using these locks, the mount becomes a "one piece" mount. Used optionally, the mount is quickly detached. The eccentric bushing in the base of the Williams QC Mount provides a limited amount of windage adjustment to insure a good mounting job.

MOUNTING PLATES:

Mounting Plate for 30-41 Carbine:— (Attach with 8-40 fillister screws.) Use the Williams SM-740 side mount base with this mounting plate. Scope can be offset or high overbore.

Mounting Plate for SMLE No. 1:— (Attach with 8-40 fillister head mounting screws.) This mounting plate is supplied with long 8-40 fillister head screws to replace SM-70 short screws. Use the SM-70 base. Mount can be installed offset or central overbore.

Mounting Plate for M1 Garand Rifle:— The mounting screws for this mounting plate are 8-40 x .475 fillister head. Use the Williams SM-740 (4 holes) side mount with this mounting plate.

SM-94/36 SIDE MOUNT ON THE 94



The QC side mount requires no drilling or tapping for the Model 94 (top eject type) Winchesters. Drilling & tapping is required on the new Side Eject Model 94 Winchesters. On the Model 336 Marlins, drill and tap just one hole.

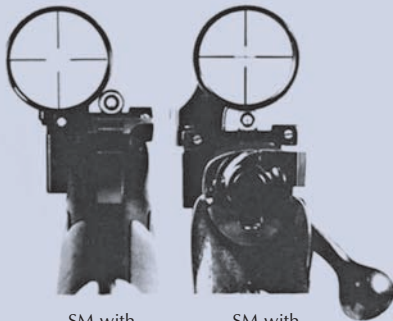

SM with Regular Rings

SM with HCO Rings

SM-71 SIDE MOUNT ON THE 94



Use SM-71 with 5D or FP Receiver Sight.

SM-94/375 ON 94 BIG BORE



Drilling & Tapping Required on 94 Big Bore Angle Eject Models.

SEE PAGE 23 FOR RINGS

SM-70 FITS:

Winchester 54, 70, 670, 770
Remington 600, 660, 700, 721, 722, Seven
Mossberg 800, 3000
Weatherby MK-V, Vanguard
Husqvarna Crown Grade
Interarms Mark X, Howa 1500/1700
Savage 110, 111
BSA Majestic, Monarch, CF-2
U.S. Military 1903/1903-A3, 1917 Enfield*
Mausers 91, 93, 94, 95, 96, 98*
British SMLE #1, (Round Receiver)**
Japanese M38 (6.5), M99 (7.7)
Swiss 1911 (7.5)
* Request Shim Pack with mount
** Requires Mounting Plate

SM-71 FITS:

Winchester 71, 86, 92, 94*, 95
Remington 14, 141
Marlin 36, 336, 93, 444, 1895
Russian 1891 (7.62)
British SMLE #4 and 5 (Flat Receiver)
* Use SM-71 on Model 94 when using FP or 5D receiver sight.
Request proper 94 screws with mount.

SM-88 FITS:

Winchester 88, 100, 190, 290, etc.
Weatherby XXII
Ruger 10/22, 44R
Browning 81 BLR
Sako Finnwolf

SM-94 FITS:

Winchester 94*, 94AE*
Marlin 336*, 30AS*, 444*, 1895*
* Use SM-71 when using FP or 5D receiver sight.

SM-94/375 Fits:

Winchester 94 Big Bore, 94 Big Bore Angle eject (.307, .356, .375)

SM-99 Fits:

Savage 99

SM-110LH FITS:

Savage 110 L.H.
Remington 700 L.H.
Weatherby MK-V L.H. } DISCONTINUED
Subject To Stock
On Hand

SM-340 FITS:

Savage 322, 325, 340*, 840
* Most 340's are factory drilled and tapped.

SM-760 FITS:

Remington 740, 742, 7400, Four, 760, 7600, Six, 552, 572
Browning BAR
Winchester 12, 1200, 1300, 1400
U.S. Military M-1 Garand*, M-1 Carbine*
* Mounting plate required.

SM-52/56 FITS:

Mannlicher-Schoenauer 1952, 1956
Greek Mannlicher 1903
Browning BPS
Winchester 05, 07, 10
Ithaca 37, 87
Ruger 77
Maverick 88
Mossberg 500

SM-KRAG FITS:

U.S. Military 1898 Krag
Remington 8, 81, 788, 870*, 1100*, 11/87
* Fits 12 gauge only

SM-MINI-14 FITS:

Ruger Mini-14 (Series 181 or higher)

SIDE MOUNT RINGS



HCO*
Central Overbore Ring
Size 1"
(For Side Bases Only)

A variation of the HCO that we occasionally run into is where a shooter wants to make use of his right shoulder and his left eye in which case the HCO rings can be reversed 180 degrees, not only positioning the scope high but off-set to the left.

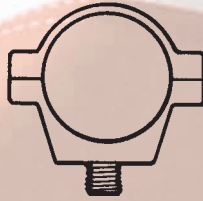

SPLIT*
Split Ring. Size 1"

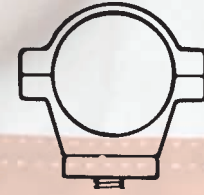

SPECIAL HIGH RINGS
Size 1"

These rings have a special long threaded stud in the base, and a sub-ring base of approx. .200 thick to accommodate the large scopes that heretofore could not be mounted low central overbore or on rifles having an especially heavy barrel. (Also available in HCO Style)

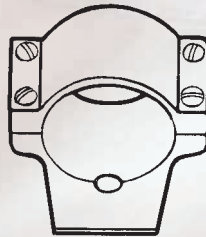

EXTENSION*

Extension Ring. Size 1". (Unless otherwise Indicated, only one extension furnished in set)

*Split sleeves to reduce 1" ring size to 7/8" and accommodate 7/8" scope tube.

(Because of the many ring combinations available, mount and rings are packaged separately.)

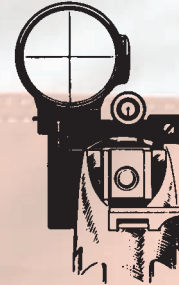

SPLIT AND EXTENSION RING

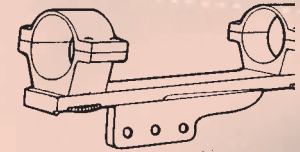

NOTE: Limited quantities of our old style solid 7/8" and 3/4" rings are available. Also, a limited amount of our split and HCO rings in 26mm diameter are available.

Prices on request.

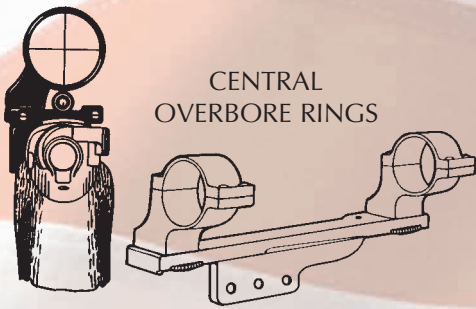

QC SIDE MOUNT - OFFSET - OR OVERBORE

From the same base, your choice of having scope in the offset or the central overbore position. In either case, you have simultaneous use of scope and iron or receiver sight. These sighting combinations are becoming more popular every day.

WILLIAMS ECCENTRIC BUSHING



All Williams QC Mounts have an eccentric bushing with a collar that can be turned with a screwdriver or similar object, to obtain preliminary adjustment AND INSURE A GOOD MOUNTING JOB.

It is not necessary to remove bushing to turn it, and it is not necessary to remove mount to obtain windage adjustment.

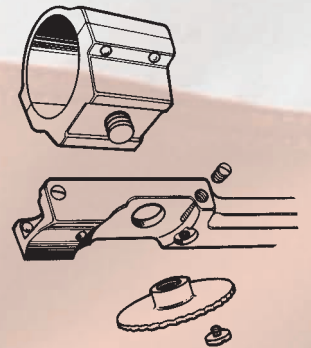
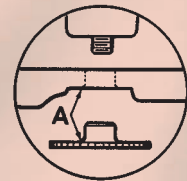

The cam-lock thumb nut bushing pulls the threaded stud down to a positive lock, locking it exactly the same each time, and assuring the return to absolute zero.

SLING SWIVELS



Standard



Quick Detachable

DIAMETER REFERENCE CHART FOR WILLIAMS RIFLE AND SHOTGUN SWIVEL ADAPTERS

CHECK BARREL DIAMETER & SELECT PROPER ADAPTER

STANDARD OR
Q.D. ADAPTER

DIAMETER

SA-T22

QD-SA-T22405-.450

SA-T22-L

QD-SA-T22-L450-.475

SA-TBM-M/L

QD-SA-TBM-M/L500-.520

SA-TBM-357

QD-SA-TBM-357545-.565

SA-TBM

QD-SA-TBM630-.680

QD-SA-20 Ga.700-.750

QD-SA-16 Ga.750-.800

QD-SA-12 Ga. 'S'800-.840

QD-SA-12 Ga. 'M'840-.875

QD-SA-12 Ga. 'L'875-.910

Adapter Swivels available in Standard or Quick Detachable sets. Specify 1" or 1-1/4" loops.

The recognized standard of the industry. Strong, light, near in appearance. Williams swivels are used by shooters all over the world who demand quality and dependability in the equipment they use.

- Strong
- Lightweight
- Steel Loops
- Made in our own Plant

SA-TBM-ML-SET



SA-TBM-ML SET for Thompson/Center Hawken and Renegade. Also fits Charles Daly muzzleloader ferrule. Diameter from .500 to .520. Includes standard stock swivel (SSS) adapter and standard front swivel.

SA-TBM-357 SET for Marlin 1894C, .357 Magnum. Diameter from .545 to .565. Also fits Rossi M92SCR .357 Magnum.

STANDARD:



SS SET

SS SET includes Standard Stock Screw Swivel (SSS) and Standard Forearm Swivel (SFS)

SA-T22 SET



SA-T22 SET (includes Standard Stock Swivel, Tubular 22 Adapter and Standard Front Swivel) Fits tubular magazines of most all 22 rifles having a diameter of .405 through .450.

SA-T22L SET for the 9422 Winchester. Diameter of .450 to .475.

SA-TBM SET



SA-TBM SET (includes Standard Stock Swivel, Tubular 94 Winchester-336 Marlin Adapter and Standard Front Swivel) Fits magazine tubes of the Marlin 336 and Winchester 94 as well as barrels of rifles having a diameter of from .630 through .680.

Quick Detachable



SLING SWIVELS

QD-RAS SET

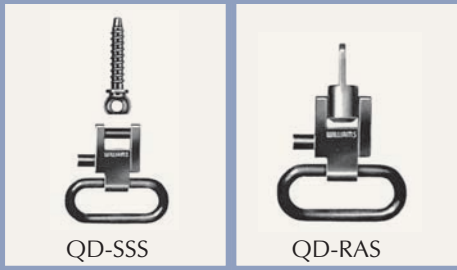

RUGER SWIVEL — Williams Swivel and adapter for Ruger 10-22, 44R carbines. (Specify Loop Width: 1", 1-1/4") (Complete with QD-SSS)

QD LOOP SET



(Specify Loop Width: 1", 1-1/4")

QD-SS SET

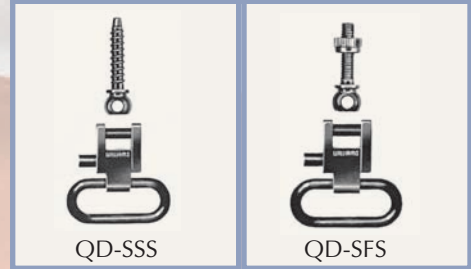

QD-MBS SET

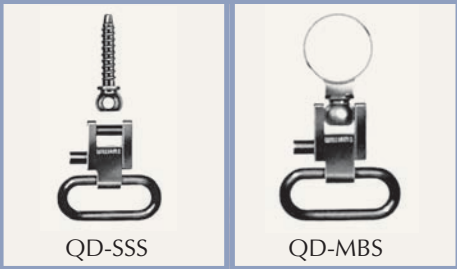

MAGAZINE BAND SWIVEL — Magazine band complete with special front swivel for 94 Winchester, 336 Marlin magazines and barrels of 650". (Specify Loop Width: 1", 1-1/4") (Complete with QD-SSS)

QD-SS-32 SET

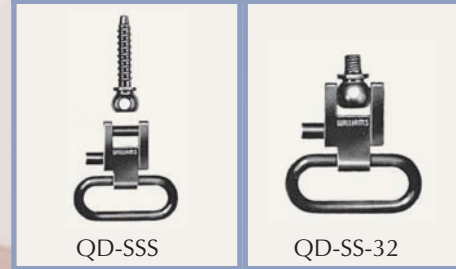

SWIVEL AND SHORT STUD 10-32 THREADS — Williams Swivel and short stud for magazine caps, forends nylon rifles etc. 10-32 threads. (Specify Loop Width: 1", 1-1/4") (Complete with QD-SSS)

QD-BJS-36 SET



DISCONTINUED
Subject To Stock
On Hand

Shown for 81 Remington. All model 81s and most model 8s drilled and tapped at the factory for this swivel. 10-36 threads. (Specify Loop Width: 1", 1-1/4") (Complete with QD-SSS)

QD-SA-T22 SET

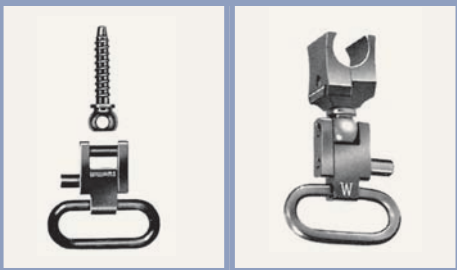

(Specify Loop Width: 1", 1-1/4")
QD-SQ-T22 SET (includes QD Stock Swivel, Tubular 22 Adapter and QD Front Swivel) Fits tubular magazines for most all 22 rifles having a barrel diameter of from .405 through .450. QD-SA-T22L SET for the 9422 Winchester. Diameter from .450 to .475.

QD-SA-TBM-ML SET

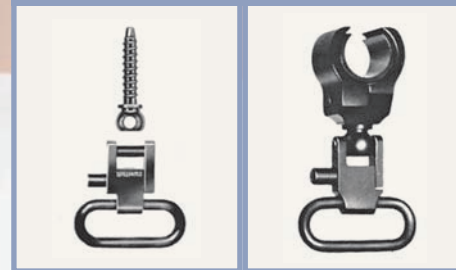

(Specify Loop Width: 1", 1-1/4")
QD-SA-TBM-ML SET for Thompson/Center Hawken and Renegade. Also fits Charles Daly muzzleloader ferrule. Diameter from .500 to .520. Includes QD stock swivel (QD-SSS) adapter and QD front swivel. QD-SA-TBM-357 SET for Marlin 1894C, .357 Magnum. Diameter from .545 to .565. Also fits Rossi M92SRC .357 Magnum.

QD-SA-TBM SET



(Specify Loop Width: 1", 1-1/4")
QD-SA-TBM SET (includes QD Stock Swivel, Tubular 94 Winchester – 336 Marlin Adapter and QD Front Swivel) Fits magazine tubes of the Marlin 336 and Winchester 94 as well as barrels of rifles having a diameter of from .630 through .680.

QD-DSS SET

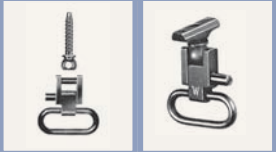

Fits all double barrel shotguns and rifles. Requires drilling and tapping. It is furnished with two 4/48 screws.

- (Specify Loop Width: 1", 1-1/4")
- QD-20 GA. SET(Includes QD Stock Swivel, Barrel Adapter and QD Front Swivel.) Fits most 20 gauge singles having barrel diameters of .700 through .750.
 - QD-16 GA. Set(Includes QD Stock Swivel, Barrel Adapter and QD Front Swivel.) Fits most 16 gauges having barrel diameters of .750 through .800.
 - QD-12 GA. 'S' SET....(Includes QD Stock Swivel, Barrel Adapter and QD Front Swivel.) Fits smaller diameter 12 gauge barrels from .800 diameter through .840.
 - QD-12 GA. 'M' SET ..(Includes QD Stock Swivel, Barrel Adapter and QD Front Swivel.) Fits 12 gauge barrels from .840 diameter through .875.
 - QD-12 GA. 'L' SET ...(Includes QD Stock Swivel, Barrel Adapter and QD Front Swivel.) Fits 12 gauge barrels with diameters above .875.

QD-12 GA 'L' SET



GUNSMITHING TOOLS

Williams Black Powder Drill Fixture

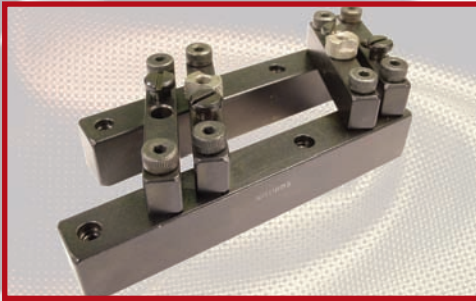

The Williams Black Powder Drill Fixture is designed primarily for installation of scope mounts and open sights on black powder guns with octagon barrels. Works on barrels with diameters between .690 and 1.175.

This fixture has four sets of hole spacings – two .860 and two .562 (9/16). The .860 hole spacing can be used for most brands of scope mounts for muzzleloaders. The .562 hole spacing is designed for use with the Williams Streamline Mount #10 & 10 with sub-blocks which allows scope installation without having to bend the hammer and usually still allows use of the open sights with scopes of 32mm objective lenses. The .562 hole spacing is also used for the Williams WGRS-ML or any of the standard WGOS Series sights.

The fixture comes complete with one each #31 and #28 hardened steel lock bushings.

Williams Scope Mount Drill Fixture

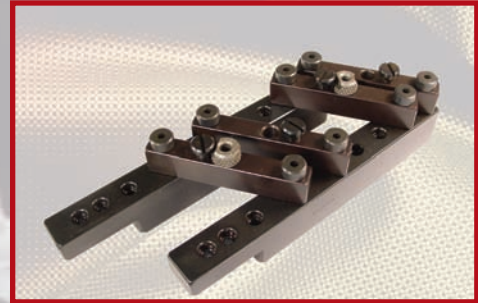

The Williams Scope Mount Drill Fixture is designed for drilling almost any receiver between the diameter of .630 to 1.440, round, flat or octagon. With a hole spacing choice of .500, .605 or .860, you can install almost any scope mount base in the industry.

The “scissors” action of the fixture will automatically center itself. The fixture comes complete with one each #31 and #28 hardened steel lock bushings for drilling #31 (6-48) and #28 (8-40) thread sizes. When locked into position, the lock bushings will not spin in the fixture, avoiding scratches around the drilled holes. After #31 holes are drilled, you can use the #28 bushing as a tap guide for 6-48 taps. You will have fewer broken taps and perfectly straight tapped holes.

The Williams Scope Mount Drill Fixture is an excellent addition to any gunsmith’s workbench.

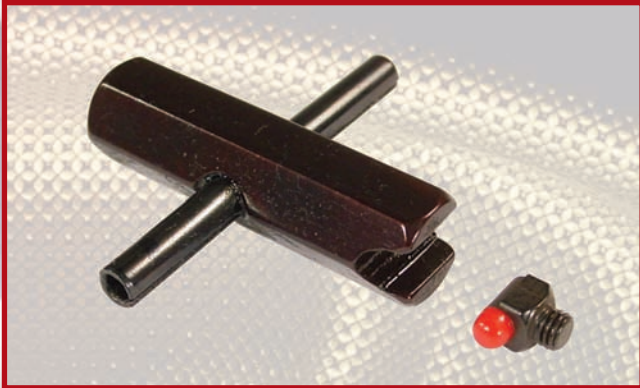

Williams Guide Bead Wrench

Designed for quick and easy installation of Williams “Guide” shotgun beads. A tool any gunsmith will appreciate.

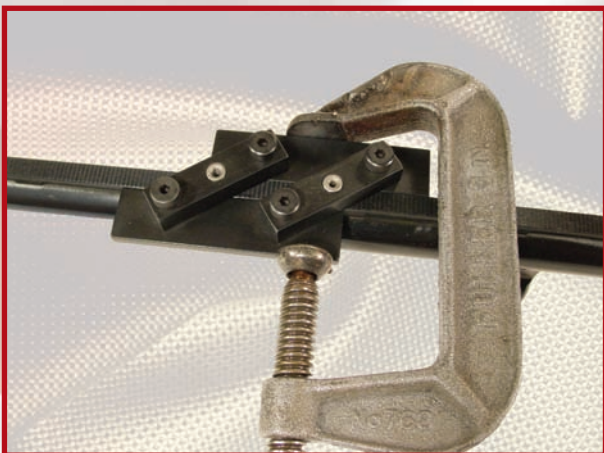
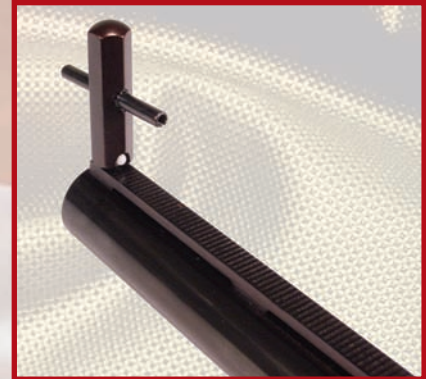

Williams Shotgun Bead Drill Fixture

*Another excellent tool for gunsmiths

This handy fixture makes installation of front and center shotgun beads on vent rib barrels quick and easy. It allows drilling for either #45 (3-56) or #31 (6-48) bead thread sizes. Simply clamp in place and drill. The “scissors” action automatically centers on the rib.

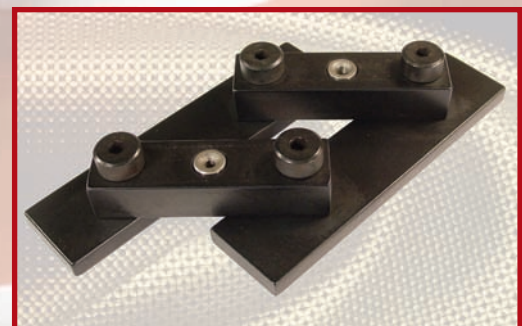

"Guide Bead" Shotgun Sights

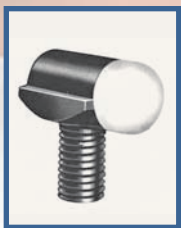

Fits all shotguns. Large 1/8" jewel finish bead has exceptional light gathering ability. Gets you on target fast. Easily installed. Screws into existing sight hole. Two thread sizes: 6-48 and 3-56, and two shank lengths, 3/32" and 5/32".

Ivory Guide Bead

6-48, 3/32 shank
6-48, 5/32 shank
3-56, 3/32 shank
3-56, 5/32 shank



Nos. 1 & 2
Front

Red Guide Bead

6-48, 3/32 shank
6-48, 5/32 shank
3-56, 3/32 shank
3-56, 5/32 shank



No. 3
Front

Gold Guide Bead

6-48, 3/32 shank
6-48, 5/32 shank
3-56, 3/32 shank
3-56, 5/32 shank



No. 4
Rear

GOLD OR SILVER SHOTGUN SIGHTS:

Model	Thread	Bead Dia.	Shank Length
No. 1	6-48	.175	1/8"
No. 2	3-56	.175	1/8"
No. 3	3-56	.130	1/8"
No. 4	3-56	.067	3/32"



Primer Pocket Peener

Enables the hand-loader to obtain more loads per shotshell. After a few reloads the primer pocket

becomes enlarged and the new primer will be too loose or will not fit at all. The PPP will resize the pocket. Just place peener through primer pocket and insert in resizing block. A light tap with hammer will bring pocket back to correct size and the shell that would normally be discarded can now be loaded again.

Gun Screws:

STANDARD IN THE GUN INDUSTRY
PACKAGED, 100 PER PACKAGE



6-48 FILLISTER HEAD SCREWS

Length .250, Head Thickness .065, Head Diameter .198
Length .350, Head Thickness .100, Head Diameter .198
Length .425, Head Thickness .100, Head Diameter .198
Length .475, Head Thickness .100, Head Diameter .198
Assortment of the Above

6-48 PLUG SCREWS

Length .090



6-48 HEADLESS SET SCREWS

Lengths: .275, .400, .575

Assortment of the above

8-40 FILLISTER HEAD SCREWS

Length .290, Head Thickness .100, Head Diameter .247
Length .350, Head Thickness .100, Head Diameter .247
Length .475, Head Thickness .100, Head Diameter .247
Assortment of the Above

8-40 OVAL HEAD COUNTERSUNK

Length .335, Head Diameter .250

8-40 PLUG SCREWS

Length .125

10-32 PLUG SCREWS

Length .125

10-32 FILLISTER HEAD SCREWS

Length .400, Head Thickness .125, Head Diameter .3075

DRILLS



No. 45.....High Speed Drill Only
(For 3-56)

No. 31.....High Speed Drill Only
(For 6-48)

No. 28.....High Speed Drill Only
(For 8-40)

No. 21.....High Speed Drill Only
(For 10-32)

TAPS



CARBON

3-56 Carbon Tap Only
6-48 Carbon Tap Only
8-40 Carbon Tap Only

HIGH SPEED

6-48 High Speed Tap Only
8-40 High Speed Tap Only
10-32 High Speed Tap Only

SETS

6-48 High Speed Tap and
No. 31 High Speed Drill Set
8-40 High Speed Tap and
No. 28 High Speed Drill Set
10-32 High Speed Tap and
No. 21 High Speed Drill Set

SMLE EXTRACTOR SPRINGS



New, and specially made from tempered spring steel. Easily fitted. Only a punch is needed.

Front Sight Pusher FOR EASY INSTALLATION AND ADJUSTMENT OF FRONT SIGHTS

In the past there was only one accepted way to install a front sight in a ramp – pound it in with a hammer from the side. This marred a beautiful finish and loosened or damaged the ramp.

The Front Sight Pusher provides the best way to install a front sight in a ramp. By equalizing the pressure on a ramp and sight, it permits installation without marring and eliminates excessive pressure on the ramp. Sight is smoothly and accurately moved into exact position

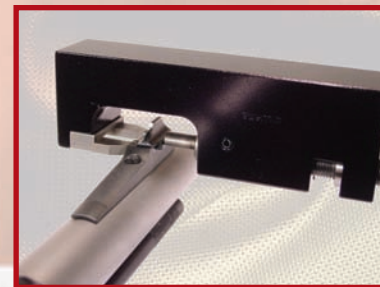

TOOLS AND ACCESSORIES

Firing Pin Kit

This kit takes care of 95% of all single and double barrel firing pin replacements. Contains 25 numbered firing pins of different styles.



No. 1 Firing Pin:

Fits Stevens 94B, 94C, 107C, 94B1, 107B1, and other Savage-Stevens single barrels made on contract in recent years.

No. 2 Firing Pin:

Fits obsolete Stevens single barrels.

No. 3 Firing Pin:

Fits Iver Johnson Champion and matted rib single made for Montgomery Ward under Western Field brand.

No. 4 Firing Pin:

Fits double barreled Fox Model B, Stevens Model 515 stamped 5000 on frame, 315 no number on frame, 530-530A-311-311A-3111 stamped 5100, 311A, or 530A on frame, or doubles made for other firms by Savage or Stevens.

No. 5 Firing Pin:

Fits Harrington and Richardson Model 48, all past and present models and any singles made by H&R for Sears-Roebuck, Montgomery Ward, etc.

— Order by Number —

Rebound Springs, No Charge



Aluminum Slot Blank

Hard, black anodized finish. For appearance sake, use this slot blank after removing iron sight. It will also cover up most burr marks. Easy installation with one locking screw. Fits all 3/8" dovetails.



20th Edition Blue Book

The 20th edition of the "Williams Blue Book of Gun Dealing" represents over thirty years of experience in buying, selling and trading used guns.

This latest edition has been extensively updated and expanded to over 9000 listings, covering virtually all commonly encountered firearms.

The Blue Book is intended as an aid to dealers and those who buy, sell and trade firearms. Prices shown indicate realistic "wholesale" values.

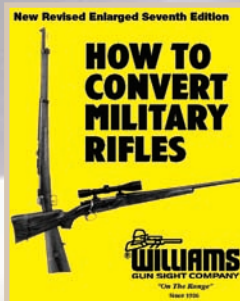

How to Convert Military Rifles.

Learn how to convert military rifles to sporting firearms with this instruction booklet

56920.....\$13.95

Shotgun Bead Kit

This kit contains a complete assortment of beads in various styles, sizes and colors. They fit any shotgun and provide a wide selection of sight combinations.

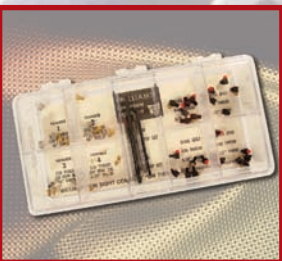

Included also are two drill and tap sets: the 6-48 and the 3-56. There are 48 beads in all, which certainly covers the needs of even the most particular and hard-to-please "gun nut."

Aperture Kit



Regular Apertures:

- 2 - R-3/8 x .050
- 1 - R-3/8 x .093
- 2 - R-3/8 x .125
- 1 - R-1/2 x .050
- 1 - R-1/2 x .093
- 1 - R-1/2 x .125
- 1 - R-3/8 x .050 L.S.
- 1 - R-3/8 x .093 L.S.
- 1 - R-3/8 x .125 L.S.
- 1 - R-1" x .050 Target

Twilight Apertures:

- 2 - TW-3/8 x .050
- 2 - TW-3/8 x .093
- 2 - TW-3/8 x .125
- 1 - TW-1/2 x .050
- 1 - TW-1/2 x .093
- 1 - TW-1/2 x .125
- 1 - TW-3/8 x .050 L.S.
- 1 - TW-3/8 x .093 L.S.
- 1 - TW-3/8 x .125 L.S.

1 - 5D Big Game

- Shotgun Aperture
- 1 - FP Big Game Shotgun Aperture
- 1 - WGRS Aperture Holder

Rifle Sight Assortment Kit

Available in seven heights with a 1/16" bead. 3/32" bead on special order. Half of the sights have a base width of .250 for the Streamlined and Shorty ramps and the other sights have a wide .340 base for the 99 Savage, 94 Winchester, 336 Marlin, etc.



Dovetail open sights available in four heights - from .290 to .450 with a 'U' type notch unless otherwise specified.

- *4 Front Sights .250 high - Gold and White - Two Widths
- *4 Front Sights .290 high - Gold and White - Two Widths
- *4 Front Sights .312 high - Gold and White - Two Widths
- *4 Front Sights .343 high - Gold and White - Two Widths
- *4 Front Sights .375 high - Gold and White - Two Widths
- *4 Front Sights .406 high - Gold and White - Two Widths
- *4 Front Sights .450 high - Gold and White - Two Widths
- *4 Williams Dovetail Open Sights - Four Heights

*DISCONTINUED Subject To Stock On Hand

Store, Smith and Gun Crank Service Kit

Selected for greatest demand. 6-48, 8-40 and 10-32 screws and taps have long since become the main general repair standbys. Any part of assortment is available. Additional plastic cases also available.



- 12 only2-56 Windage Screws
- 12 only6-48 x .350 F.H.
- 12 only6-48 x .285 F.H.
- 12 only8-40 x .335 O.H.
- 12 only6-48 x .170 F.H.
- 12 only6-48 x .260 T.H.
- 6 only8-40 x .290 F.H.
- 6 only8-40 x .475 F.H.
- 12 only8-40 x .125 H.L. plug screw
- 12 only6-48 x .090 H.L. plug screw
- 12 only6-48 x .187 H.L. set screw
- 1 only6-48 Drill & Tap set
- 1 only8-40 Drill & Tap set

TOOLS AND ACCESSORIES



Full Moon Clip:

For .45 ACP
Revolvers
3-Pack



Ball Compass:

Easy Pin On
Luminous Pointer
Hermetically Sealed
Lightweight
Waterproof
Shockproof



Garand Clip

5 Shot Garand
For hunting, most states
limit the magazine capacity
to five shot.

Shoulder Button:



Anyone who has done much hunting knows how important it is to be able to use both hands and not have the sling continuously sliding off the shoulder. For years shooters have been improvising various means of keeping the rifle and sling strap in the proper position. The Guide Shoulder Button is the answer. It attaches quickly to jacket, shirt or coat. Keeps sling and rifle in position desired. It's comfortable and easy to use, also provides an added degree of safety. May be changed from one garment to another.

Targets

Finest target ever under fire. Used over the years by Col. Townsend Whelen, Phil Sharpe, Warren Page, and most other leading authorities for practically all their own testing work. Clock-like overlay added to official small bore dimensions results in real accuracy and dial system of calling. Front sight or scope reticle stands out at any distance against white bullseye surrounded by two rings of solid black. In the course of a year we test many thousands of

guns in our Service Department. We have found that the white-centered target has saved us hundreds of dollars in the cost of ammunition expended. The clear white center gives the shooter a clear-cut aiming point. Whether you use a telescope, receiver sight or open sight, you will find that the white-centered target makes it much easier to locate your reticle or front sight under all light conditions. The Williams targets are printed on NRA target paper.

Minimum
order
100

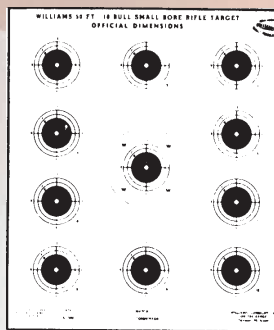

50 Ft. Small Bore Ten Bull
(Wt: 1 lb. 9 oz. per 100)
10-1/2" x 12"

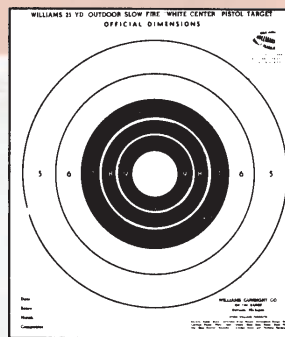

25 Yd. Outdoor Slow Fire Pistol
(Wt: 1 lb. 9 oz. per 100)
10-1/2" x 10-1/2"

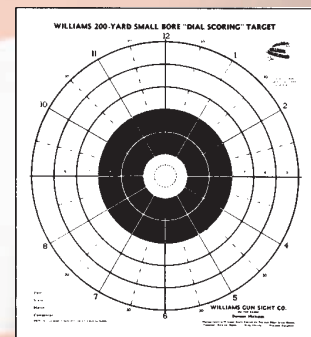

200 Yard Small Bore DS
(Wt: 5 lbs. 10 oz. per 100)
21" x 24"



25 Yd. Outdoor Center Only Pistol
(Wt: 1 lb. 2 oz. per 100)
10-1/2" x 10-1/2"

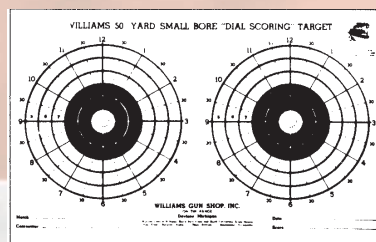

50 Yd. Small Bore DS Two Bull
(Wt: 1 lb. 7 oz. per 100)
9" x 14"

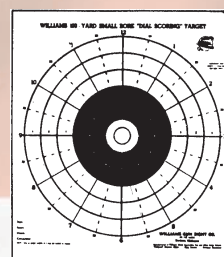

100 Yd. Small Bore DS
(Wt: 2 lbs. per 100)
14" x 14"

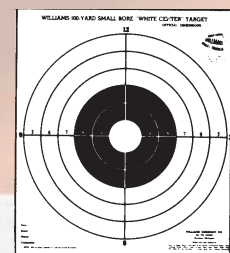

100 Yd. Small Bore WC
(Wt: 2 lbs. per 100)
14" x 14"

GUNSMITH SERVICES

Williams Gunsight Company Inc. is an authorized warranty repair center for:

U.S.
Repeating Arms
Company Inc.

Weatherby
AUTHORIZED SERVICE CENTER



Browning
BROWNING®

Remington
Remington Premier Field Service Center

ALL WARRANTY REPAIR IS FREE TO CUSTOMER.

Includes cleaning on all Remington 700 Trigger systems

NOTE: When disassembly is required, all guns will be test fired at a labor rate of \$6.00 per gun plus ammo used.



WILLIAMS GUIDE SERIES BRAKE



REDUCES RECOIL UP TO 65%

The Guide Series Brake is 10 to 15% better than any brake we have tested. At no charge to you we have included a knurled thread protector. Also, our gunsmiths will blend the brake to your barrel at no extra charge. No additional charges for autos or short barrels.....\$179.00

Dealer Prices Available

Calibers	Total Rifle Weight	Energy In foot Pounds	"Factory" Bullet Weight	Recoil Reduced To:	Energy In foot Pounds
460 WBY	11.5	98	500	375 H&H	32.5
416 Rem.	10.25	56	400	338 Win.	21.5
375 H&H	10.5	43	300	30/06	14.4
338 Win.	9	38	250	270 Win.	11.7
300 Win.	8.5	31	200	243 Win.	11
7 mm R.	8.5	26	175	243 Win.	8
30/06	8	24	200	243 Win.	6.3
270 Win.	8	17	150	223 Rem.	5.4

Please Note: When sending a firearm in for service, please send full instructions attached to the outside of the carton, even though there may have been previous correspondence.

P.O.R - Price on Request

Custom brakes available at P.O.R. including HK 91, 95, FN-FAL and AR-15 using factory threads.

WEATHERBY ACCUBRAKE INSTALLATIONS.....\$159.00

SECOND SKIN CAMO-Call or visit www.williamsgunsight.com for available patterns.

SHOTGUNS

Complete Shotgun*	\$205.00
Over & Under Shotgun*	\$225.00
Stock Only	85.00
Forearm Only	85.00
Barrel Only — Single	100.00
Barrel — Over & Under	130.00
Receiver Only	100.00
Synthetic Stocks & Forearm	add 10.00

RIFLES

Complete Rifle*	205.00
Black Powder Rifle*	205.00
Rifle Stock Only	115.00
Rifle Barrel Only	125.00
Synthetic Stocks	(add) 10.00

HANDGUNS

Complete Pistol	205.00
-----------------	--------

*Note: Complete Guns do not include trigger guards, floor plates, bolts or ramrods. With the exception of ramrods, these items can be camouflaged on the handle only. (These items are not under warranty).

Six to eight weeks turn around on second Skin Camo.

PRICES SUBJECT TO CHANGE WITHOUT NOTICE

GUNSMITH SERVICES

COWBOY GUNS

Custom Sight Applications	P.O.R.
Complete Action and Trigger Jobs on Colt and Ruger S.A (Parts Extra).....	\$100-120.00
Lever Action Trigger and Action Jobs	85.00-125.00
Single Action Grip Fitting.....	P.O.R.
Retiming (Parts Extra).....	35.00-55.00
Install Free Spin Pawl on Rugers (Parts Extra)	35.00-60.00
Point of Impact Adjustments on S.A.	P.O.R.
Install Short Stroke Kits	P.O.R.

METAL FINISHES

REBLUING	PARKERIZING		SATIN	POLISHED	WEATHERBY	MIRROR
	BLACK OR GRAY	GUN KOTE	SAND BLAST	BEAD BLAST	4-500 GLOSS	FINISH
Single Barrel Shotgun.....	\$150.00	150.00	\$95.00	\$105.00	\$115.00	N/A
Bolt Action Rifles	175.00	200.00	105.00	140.00	150.00	215.00
Pump or Auto Shotgun and Rifles	175.00	200.00	105.00	140.00	150.00	225.00
Pump or Auto Shotgun without ribs	175.00	200.00	105.00	120.00	130.00	190.00
1911 Style Pistols	175.00	200.00	95.00	120.00	130.00	230.00
A-5 Style Shotguns & Model 12 Win.	200.00	220.00	125.00	200.00	225.00	P.O.R.
Hard Soldered O&U Shotguns and Double Barrels.....	200.00	200.00	120.00	200.00	250.00	N/A
Lever Action Rifles.....	200.00	220.00	115.00	170.00	190.00	P.O.R.
Barrels Only (No Rib)	80.00	100.00	55.00	75.00	75.00	105.00
Barrels Only (With Rib).....	80.00	100.00	60.00	95.00	105.00	150.00
Muzzleloaders (Dip Only -- \$35.00).....		150.00	75.00	165.00	200.00	N/A
Revolvers	175.00	200.00	95.00	150.00	175.00	P.O.R.
Remington Models: 8, 81, 10, 24, 141, 14, 31		250.00	150.00	200.00	250.00	N/A
Winchester Models: 03, 06, 71, 86, 92, 95, 97, 07, 10, 63, 88.....		250.00	150.00	250.00	250.00	N/A

Parkerizing with gunkote toughest finish available (Available at 10% DISCOUNT on both prices)

RESTORATIONS ON ANTIQUE GUNS & FACTORY GUNS (Restorations available at P.O.R.)

KG Gun Kote is a thin hard coating that can be applied to any ferrous or nonferrous metal and even some plastics. KG Gun Kote was first developed for use on military weapons to meet a need for a material that would hold up under adverse conditions. The coating needed to withstand 500 hour salt spray tests and still meet military machine gun firing requirements. Gun Kote does this and its usage has grown from firearms to automotive and motorcycles. Gun Kote is formulated with Moly and/or Teflon for self lubrication and is available in tan, brown silver, stainless steel and gold. Colors are also available in high gloss and flat.



Now in 15 Unique Patterns!
Including mirage flage, 61 colors available. See examples at www.williamsgunsight.com
\$250-\$325.00 installed

Examples at www.williams.com

Cyanide Case Color Receivers	\$220.00
Bone and Charcoal Case Color Receivers:	
Small - Colt SA, Stevens Favorite, etc.....	220.00
Large - Winchester High & Low Wall; Doubles, etc.....	250.00
Bone and Charcoal Case Color Win. 73, 76, 86	285.00
Color Case Butt Plate, Hammer & Trigger guards	70.00
(if more than one)	45.00 each
Rust Blue Most Double Barrels	190.00 to 250.00
All Octagon Barreled Guns Will Be Extra	P.O.R.
Engraved Guns Will Be More	P.O.R.
Highly Rusted or Pitted Guns Will Be More	P.O.R.

GUN KOTE WILL PROVIDE:

1. Outstanding corrosion protection. Gun Kote will withstand a minimum of 500 hour salt spray tests at 5% salt. Tests performed for Armscor by the South African Naval Logistics Dept. showed Gun Kote will withstand an equivalent of a 7 year exposure. (tests were performed on aluminum in a salt spray chamber with 50/50 on/off time at 35 degrees C.
2. Resistance to chemicals, oils and solvents common to the firearm and aircraft/aerospace industries.
3. Heat dissipation which will help keep parts cool.
4. Temperature resistance. gun kote will withstand over 500 degrees F and as low as -350 degrees F.

Restoration on Antique Guns	P.O.R.
Hard Chrome, Gold and Other Finishes Are Available	P.O.R.
Bolt Alteration (Bolt Handle Extra)	95.00
Damascene Bolt and Follower	95.00
Checker Bolt Handle	(Per Panel) 70.00
Install Douglas or Shilen FTC Barrel (Bbl. Extra)	80.00 to 100.00
Install Barrel From Blank	min. 230.00
Reline .22 Barrel or 17 Cal + parts	135.00
Cut Extractor Slot on Barrel Installation.....	55.00
GunKote Trigger Guards	25.00
Milling Lightening Cuts in Rifle Action.....	P.O.R.

GUNSMITH SERVICES

PISTOLSMITHING

Standard Trigger work	Min. \$75.00
Target Trigger Work	Min. 125.00
Lower Ejection Port. Gov't. 45	60.00
Widen Barrel Ramp and Polish Mag Well	70.00
Install Thumb or Grip safety	Min. 40.00
Open Bottom of Mag Well	35.00

Revolver Barrel Installation	P.O.R.
Install Wilson Style Grip Safety	85.00
Checker Front Strap	220.00
Checker Rear Strap	200.00
Install Comp on Barrel	P.O.R.
Install Extended Mag well	P.O.R.
Custom Sights and Other custom Parts Installations Available	P.O.R.

SERVICE WORK - All Warranty repairs FREE to customer includes cleaning on all Remington 700 Trigger systems

Shorten and crown barrels of Rem. 760, 740: Savage 99; Win 100 and 88 (or any rifle barrel under 18")	100.00
Shorten and crown rifle barrels other than above	50.00
Cut and crown shotguns and re-install bead	55.00
Cut, crown and install bead on double barrel	60.00
Chamber cast	40.00
Boring shotgun to desired choke (Per Barrel)	65.00
Bore shotgun with chrome barrel	75.00
Remove military sights	ea. 20.00
Sight in Rifle or Shotgun	20.00 plus ammo

Chambering 12, 20, and 410 gauge shotguns to 3" Per Barrel	65.00
Rechamber short chambered barrels to modern 2-3/4" forcing cone (Per Barrel)	65.00
Converting 2-9/16" Browning Auto to 2-3/4" (If Necessary to replace cracked forend, additional)	170.00
Converting 2-9/16" Winchester Model 12 (16 and 20 ga.) to 2-3/4"	170.00

INSTALLATIONS

Install "Screw-On" types of ramps w/ drilling & tapping	\$30.00
Drilling and Tapping Savage 99 for FP receiver sight	35.00
Drilling and Tapping for most 5D and FP receiver sight	30.00
WGRS top mounted (when not drilled and tapped)	30.00
Installation of receiver sights when not necessary to drill & tap	18.00
Install open sight base and WGOS	30.00
Install Tru-Choke 12 and 20 ga. (Tubes Extra)	85.00
Install Tru-Choke 10 ga. (Tubes Extra)	125.00
Install 3 position safeties on Mausers, Remington, etc.	P.O.R.
Express Sights + Impact Adjustment	P.O.R.
Install mounts when drilling and tapping is required	60.00
Express Sight installation per sight (refinishing extra)	75.00

Install Talbot Mounts	\$75.00
Drill and tap hardened receivers; Ruger Mini-14 Stainless and 77; Savage 99; Enfields; Springfields- where carbide drills are required	85.00
Install pistol mounts	60.00
Install side mount on 30 carbine, M1 Garand and MIA	85.00
Install leather recoil pad (Pad Extra)	90.00
Install Buehler Safety	Min. 30.00
Change safety on 870-1100 from right to left	50.00
Install Timney Trigger or other brands	45.00 to 75.00
Bore sight gun	7.50

RIFLE ACCURIZING & SHOTGUN ACCURIZING

Accuracy check includes testing scope & testing rifle in a free floated stock if necessary	25.00 to 60.00
Lap locking lugs	\$60.00
May need re-headspacing after lapping lugs	P.O.R.
Install Sako extractors	95.00
True front of receiver	60.00
True bolt face	70.00
Lap Barrel	75.00
Adjust adjustable rifle trigger	40.00 to 55.00
Adjust rifle trigger when honing is needed Mod 70 Win, Ruger 77 MKII all lever rifles	Min. 75.00
Install pre-threaded barrel	80.00 to 100.00

Custom barrel installation	230.00
Blueprint action	185.00
Cryo-Accurizing	80.00
Custom chambering	P.O.R.
Glass bed action	95.00
Glass bed lug only	75.00
Free float barrel	65.00
Pillar bed rifle (includes free float barrel)	190.00
Shotgun "SLUG" accurizing available	P.O.R.
Trigger Job on 870-1100-742-7400	50.00
Lap Scope Rings	40.00
Deweight Rifle Action	350.00-450.00

— COMPLETE ENGRAVING SERVICE AVAILABLE —
By Joe Rundell

STOCK WORK

STOCK FINISHES:

Satin Oil Finish	\$120.00
Deluxe Satin Oil Finish (Pores will be completely filled)	150.00
High Shine Weatherby Grade Finish	250.00- 300.00
Satin Varathane	115.00
NOTE: Deduct \$10.00 for small wood stocks such as Stevens Crackshot	
Guns with Fancy Checkering	P.O.R.
Guns with Bad dings, Cracks or Grease Deterioration	P.O.R.
Recheckering	P.O.R.
Install Skeleton Grip cap or Butt Plate	P.O.R.
Reduce wight or skeletonize stock	P.O.R.

Complete Checkering and Custom Stocks Available, Wood and Glass	P.O.R.
Also Available: Complete Stock Restorations, Replacement to Original Size and Specs or Special Dimensions	P.O.R.
Inlet bolt Handle into Stock and Receiver	45.00
Mortising of Stock when Installing Receiver Sight	30.00
Install Recoil Pad (Pad Additional)	45.00
Cut Stock and Install Recoil Pad (Plus Pad)	50.00
Add Spacers and Install Recoil Pad (Pad Extra)	70.00
Extra, for cut	5.00
Install McMillan or other Composite stocks	P.O.R.

PRICES SUBJECT TO CHANGE WITHOUT NOTICE

FOR MORE GUNSMITHING SERVICES AND CUSTOM GUN PHOTOS VISIT:

WWW.WILLIAMSGUNSIGHT.COM

800-530-9028

WILLIAMS MUZZLELOADER ACCESSORY CHART

MODEL	SCOPEMOUNTS		RECEIVER SIGHTS		FRONT SIGHT COMBINATION WITH RECEIVER SIGHT		OPEN SIGHTS	FRONT SIGHT COMBINATION WITH OPEN SIGHT	SWIVEL SET
	SIGHT THRU	STREAM-LINE MOUNT	FP	WGRS	WITH FP	WITH WGRS	WGOS	WITH WGOS	
CONNECTICUT VALLEY ARMS INC.									
APOLLO	T-T	23-23	—	WGRS-CVA	—	—	WGOS-OCTAGON -CVA-1/4	—	QD-TBM-ML
BUSHWACKER	T-T	23-23	—	WGRS-CVA	—	—	WGOS-OCTAGON -CVA-1/4	—	QD-TBM-ML
FRONTIER HUNTER	T-T	23-23	—	WGRS-CVA	—	—	WGOS-OCTAGON -CVA-1/4	—	QD-TBM-ML
TRACKER	T-T	23-23	—	WGRS-CVA	—	—	WGOS-OCTAGON -CVA-1/4	—	QD-TBM-ML
TROPHY	T-T	23-23	—	WGRS-CVA	—	—	WGOS-OCTAGON -CVA-1/4	—	QD-TBM-ML
WOLF	T-T	23-23	—	WGRS-CVA	—	—	WGOS-OCTAGON -CVA-1/4	—	QD-TBM-ML
MODERN MUZZLELOADING									
KNIGHT MK85	F-F	16-16	FP-KNIGHT	WGRS-KN	—	—	—	—	QD-TBM-ML
LEGEND, DISC, BIGHORN, T-BOLT WOLVERINE AND AMERICAN	O-O	11-11	FP-LEGEND	WGRS-LEGEND	3/16-375N	3/16-375N	WGOS-XL-5/16	3/16-375N	QD-TBM-ML
	O-O	11-11	FP-LEGEND	WGRS-LEGEND	3/16-375N	3/16-375N	WGOS-XL-5/16	3/16-375N	QD-TBM-ML
THOMPSON/CENTER ARMS									
HAWKEN	U-U*	10-10*	FP-HAWKEN (PRE 1991)	WGRS-CVA*	.500W	.500W	WGOS-OCTAGON -T/C-1/4	.500W	QD-TBM-ML
RENEGADE	U-U*	10-10*	FP-HAWKEN (PRE 1991)	WGRS-CVA*	.500W	.500W	WGOS-OCTAGON -T/C-1/4	.500W	QD-TBM-ML
WHITE MT. CARBINE	U-U*	10-10*	—	WGRS-CVA*	—	.500W	WGOS-OCTAGON -T/C-1/4	.500W	—
NEW ENGLANDER	J-J*	—	—	WGRS-H&R*	—	.500W	WGOS-ROUND -T/C-1/4	.500W	QD-TBM-ML
GREY HAWK	—	—	—	WGRS-H&R*	—	.500W	WGOS-ROUND -T/C-1/4	.500W	—
SCOUT	—	TM-T/C SCOUT	FP-T/C SCOUT	—	.570W	—	WDOS-1/4	.500W	—
BLACK DIAMOND	Z-Z	26-26	—	WGRS-BLACK DIAMOND	—	.500W	—	—	—
TRADITONS									
DEER HUNTER	T-T	23-23	—	WGRS-CVA	—	.500W	WGOS-OCTAGON -CVA-1/4	.500W	—
IN-LINE	R-R	24-24	—	—	—	—	WGOS-XL-1/4*	—	QD-LOOPSET
WHITE SYSTEMS									
WHITETAIL	—	—	FP-WHITETAIL	WGRS-WHITETAIL	—	—	WGOS-L-5/16	5/16-.290N	—

*Drilling and Tapping required.

Note: CVA front sight dovetails are usually metric, not 3/8"

WILLIAMS ACCESSORY CHART FOR SLUG SHOTGUNS

MODEL	SCOPEMOUNTS			RECEIVER SIGHTS			SWIVEL SET	COMMENTS
	SIDE MOUNT	SIGHT THRU	STREAM-LINE MOUNT	FP	5D	WGRS		
BROWNING								
Auto-5 Buck Special	—	—	—	FP-SSM	5D-SSM	—	QD-SS	Install swivel magazine cap.
BPS-10 Buck Special	SM-.52/56	—	—	FP-11/87	—	WGRS-37	QD Loop Set	
BPS-12 Buck Special	SM-.52/56	—	—	FP-11/87	—	WGRS-37	QD Loop Set	
ITHACA								
87 Deerslayer II	SM-.52/56	A-B*	1-2*	FP-12/37	5D-12/37	—	QD-12ga.-L	
MAVERICK								
88 Slugster	SM-.52/56	J-J	7-7	FP-71	—	WGRS-37	QD Loop Set	
MOSSBERG								
500 Slugster Pre 1997	SM-.52/56	J-J*	7-7*	—	—	—	QD-SS-32	Fixed factory front sight too low for receiver sights.
500 Slugster 1997 & After	—	Y-Y*	25-25*	—	—	—	QD-SS-32	
REMINGTON								
870 Deer Gun	SM-Krag	A-B	1-2	FP-11/87	—	WGRS-WR	QD-SS	Install swivel in magazine cap.
1100 Deer Gun	SM-Krag	—	—	FP-11/87	—	WGRS-WR	QD-SS	Install swivel in magazine cap.
11/87 Deer Gun	SM-Krag	—	—	FP-11/87	—	WGRS-WR	Factory Swivels	
WINCHESTER								
1300 Slug Hunter	SM-760	W-W*	6-6*	FP-71	—	WGRS-WIN	QD-12ga.-L	Use .343M front sight with WGRS.
1300 Ranger-Deer	SM-760	W-W*	6-6*	FP-71	—	WGRS-WIN	QD-12ga.-L	Use .343M front sight with WGRS.
1400 Slug-Hunter	SM-760	W-W*	6-6*	FP-71	—	WGRS-WIN	QD-12ga.-L	Use .343M front sight with WGRS.

*Fits Factory Drilling and Tapping

WILLIAMS ACCESSORY CHART

MODEL	SCOPE MOUNTS			RECEIVER SIGHTS			FRONT SIGHT COMBINATION WITH RECEIVER SIGHT		OPEN SIGHTS		FRONT SIGHT COMBINATION WITH OPEN SIGHT		SWIVEL SET	COMMENTS
	SIDE MOUNT	SIGHT THRU	STREAM-DOVETAIL LINE MOUNT	FP	5D	WGRS	WITH FP/5D	WITH WGRS	WGOS	WDOS	WITH WGOS	WITH WDOS		
BROWNING														
BAR-STANDARD	SM-760	G-G	7-7	FP-BAR	—	WGRS-BAR	7/16-343N	9/16-343N	WGOS-L-3/16	—	7/16-343N	—	QD Loop Set	
BAR-MAGNUM	SM-760	G-G	7-7	FP-BAR	—	WGRS-BAR	7/16-343N	7/16-343N	WGOS-26mm-5/16	—	7/16-343N	—	QD Loop Set	
A-BOLT SHORT ACTION	—	C-C	3-3	FP-A.BOLT	—	WGRS-70	9/16-406N	9/16-406N	WGOS-L-5/16	—	7/16-312N	—	QD Loop Set	
A-BOLT LONG ACTION	—	C-C	3-3	FP-A.BOLT	—	WGRS-70	9/16-406N	9/16-406N	WGOS-L-5/16	—	7/16-290N	—	QD Loop Set	
A-BOLT MAGNUM-LONG ACTION	—	C-C	3-3	FP-A.BOLT	—	WGRS-70	9/16-375N	9/16-375N	WGOS-L-5/16	—	7/16-312N	—	QD Loop Set	
A-BOLT MICRO ACTION	—	C-C	3-3	FP-A.BOLT	—	WGRS-70	9/16-406N	9/16-406N	WGOS-L-5/16	—	7/16-312N	—	QD Loop Set	
A-BOLT 22	—	C-C	3-3	—	—	WGRS-70	—	9/16-406N	WGOS-L-5/16	—	7/16-290N	—	QD Loop Set	
81BLR	SM-88	O-O	7-7	FP-71	—	WGRS-BAR	.450M	.570M	WGOS-M-3/16	—	.406M	—	QD-TBM	
INTERARMS														
MARK X VISCOUNT	SM-70	D-I	14-15	FP-FN	—	WGRS-FN	7/16-375N	7/16-375N	WGOS-M-3/16	—	7/16-375N	—	QD Loop Set	
HOWA LIGHTNING	SM-70	D-E	4-5	FP-70AP	5D-70	WGRS-700	7/16-343N	7/16-343N	WGOS-Special-5/16	—	7/16-343N	—	QD Loop Set	
MARLIN														
336CS	SM-94/36	H-H	8-8	FP-94/36	5D-94/36	—	.343M	—	—	WDOS-5/16	—	.290M	QD-TBM	
30AS	SM-94/36	H-H	8-8	FP-94/36	5D-94/36	—	.570M	—	—	WDOS-5/16	—	.538M	QD-TBM	
1894S	—	H-H	8-8	FP-94/36	5D-94/36	—	.343M	—	—	WDOS-5/16	—	.290M	QD-TBM	
1894CS	—	H-H	8-8	FP-94/36	5D-94/36	—	.538M	—	—	WDOS-5/16	—	.538M	QD-TBM-357	
1894CL	—	H-H	8-8	FP-94/36	5D-94/36	—	.450M	—	—	WDOS-5/16	—	.450M	QD-TBM-357	
1895SS	SM-94/36	H-H	8-8	FP-94/36	5D-94/36	—	.290M	—	—	WDOS-5/16	—	.290M	QD Loop Set	
444SS	SM-94/36	H-H	8-8	FP-94/36	5D-94/36	—	.290M	—	—	WDOS-5/16	—	.290M	QD Loop Set	
9	—	H-H	8-8	FP-M9	—	—	.538M	—	—	WDOS-5/16	—	.290M	QD Loop Set	
45	—	H-H	8-8	FP-M9	—	—	.538M	—	—	WDOS-5/16	—	.290M	QD Loop Set	
39AS	—	—	—	FP-39	5D-39	—	.290M	—	—	WDOS-5/16	—	.290M	QD Loop Set	
39TDS	—	—	—	FP-39	5D-39	—	.290M	—	—	WDOS-5/16	—	.290M	QD Loop Set	
15YN	—	—	—	—	—	WGRS-54	—	9/16-343N	—	WDOS-5/16	—	.290M	QD-T22	
25N/25MN	—	—	—	2-Piece	—	WGRS-54	—	9/16-343N	—	WDOS-1/4	—	3/16-343N	QD-SS	Use Shorty Ramp
60	—	—	—	2-Piece	—	WGRS-54	—	9/16-343N	—	WDOS-1/4	—	3/16-312N	QD-SS	Use Shorty Ramp
70HC	—	—	—	1-Piece	—	—	9/32-312N	—	—	WDOS-1/4	—	3/16-312N	QD-T22	Use Shorty Ramp
70P	—	—	—	1-Piece	—	—	9/32-312N	—	—	WDOS-1/4	—	3/16-312N	QD-SS	Use Shorty Ramp
75C	—	—	—	1-Piece	—	—	9/32-343N	—	—	WDOS-1/4	—	3/16-312N	—	Use Shorty Ramp
860/881	—	—	—	1-Piece	—	—	9/32-312N	—	—	WDOS-1/4	—	3/16-312N	QD-T22	Use Shorty Ramp
882/883	—	—	—	2-Piece	—	WGRS-54	—	9/16-343N	—	WDOS-1/4	—	3/16-312N	QD Loop Set	Use Shorty Ramp
995	—	—	—	2-Piece	—	WGRS-54	—	9/16-343N	—	WDOS-1/4	—	3/16-312N	QD Loop Set	Use Shorty Ramp
995	—	—	—	1-Piece	—	—	9/32-312N	—	—	WDOS-1/4	—	3/16-312N	QD-SS	Use Shorty Ramp

WILLIAMS ACCESSORY CHART

MODEL	SCOPE MOUNTS			RECEIVER SIGHTS			FRONT SIGHT COMBINATION WITH RECEIVER SIGHT		OPEN SIGHTS		FRONT SIGHT COMBINATION WITH OPEN SIGHT		SWIVEL SET	COMMENTS	
	SIDE MOUNT	SIGHT THRU	STREAM-LINE MOUNT	DOVETAIL MOUNT	FP	5D	WGRS	WITH FP/5D	WITH WGRS	WGOS	WDOS	WITH WGOS			WITH WDOS
REMINGTON															
SEVEN	SM-70	D-E	4-5	—	FP-70AP	5D-70	—	7/16"-343N	—	WGOS-M-3/8	—	7/16"-343N	—	QD Loop Set	Specify ramp with Remington hole spacing
700 ADL	SM-70	D-E	4-5	—	FP-70AP	5D-70	WGRS-700	7/16"-343N	—	WGOS-L-3/8	—	7/16"-343N	—	QD-SS	Specify ramp with Remington hole spacing
700 BDL	SM-70	D-E	4-5	—	FP-70AP	5D-70	WGRS-700	7/16"-343N	—	WGOS-L-3/8	—	7/16"-343N	—	QD Loop Set	Specify ramp with Remington hole spacing
700 BDL-LH	SM-70	D-E	4-5	—	FP-98AP	—	WGRS-700	7/16"-343N	—	WGOS-L-3/8	—	7/16"-343N	—	QD Loop Set	Specify ramp with Remington hole spacing
700 VARMINT	SM-70	D-E	4-5	—	FP-70AP	5D-70	WGRS-700	5/16"-343N	—	WGOS-L-5/16	—	5/16"-343N	—	QD Loop Set	—
700 MT. RIFLE	SM-70	D-E	4-5	—	FP-70AP	5D-70	WGRS-700	7/16"-343N	—	WGOS-S-3/8	—	7/16"-343N	—	QD Loop Set	—
742/760	SM-760	A-B	1-2	—	FP-740AP	5D-760N	WGRS-742	3/8"-343N	—	WGOS-M-5/16	—	7/16"-343N	—	QD-TBM	Specify ramp with Remington hole spacing
7400/FOUR	SM-760	R-S	17-18	—	FP-740AP	5D-760N	WGRS-7400	7/16"-343N	—	WGOS-Special 5/16	—	7/16"-343N	—	QD-TBM	Specify ramp with Remington hole spacing
7600/SIX	SM-760	R-S	17-18	—	FP-740AP	5D-760N	WGRS-7400	7/16"-343N	—	WGOS-Special 5/16	—	7/16"-343N	—	QD-TBM	Specify ramp with Remington hole spacing
7400/7600 CAR.	SM-760	R-S	17-18	—	FP-740AP	5D-760N	WGRS-7400	7/16"-343N	—	WGOS-Special 5/16	—	7/16"-343N	—	QD-TBM	Specify ramp with Remington hole spacing
788	SM-Krag	R-S	9-9	—	FP-788	—	—	9/16"-312N	—	WGOS-M-3/8	—	9/16"-312N	—	QD-SS	Use FP-70AP on non-drilled & tapped models
552 BDL	SM-760	—	—	1-Piece	FP-GR	—	WGRS-54	—	—	WGOS-M-1/4	—	—	—	QD-T22	Use Remington factory ramp
572 BDL	SM-760	—	—	1-Piece	FP-GR	—	WGRS-54	—	—	WGOS-M-1/4	—	—	—	QD-T22	Use Remington factory ramp
RUGER															
77R	SM-52/56	H-P	—	—	FP-RU77	—	—	7/16"-343N	—	WGOS-M-3/8	—	7/16"-343N	—	QD Loop Set	—
77RL	SM-52/56	H-P	—	—	FP-RU77	—	—	7/16"-312N	—	WGOS-M-3/8	—	7/16"-312N	—	QD Loop Set	—
77V	SM-52/56	H-P	—	—	FP-RU77	—	—	3/8"-343N	—	WGOS-L-5/16	—	3/8"-343N	—	QD Loop Set	—
77 MARK II	SM-52/56	H-P	—	—	FP-RU77	—	—	7/16"-312N	—	WGOS-M-3/8	—	7/16"-312N	—	QD Loop Set	—
77/22R	SM-52/56	H-P	—	—	FP-RU77	—	—	7/16"-312N	—	WGOS-M-3/8	—	7/16"-312N	—	QD Loop Set	—
10/22R	SM-88	L-M	13-12	—	FP-RU	5D-RU	WGRS-RU22	.450M	.570M	WGOS-M-3/16	—	.538M	—	QD-RAS	—
10/22 DSP	SM-88	L-M	13-12	—	RP-RU	5D-RU	WGRS-RU22	.450M	.570M	WGOS-M-3/16	—	.538M	—	—	—
MINI-14/5	SM-MINI-14	—	—	—	FP-MINI-14	—	—	—	—	—	—	—	—	—	—
MINI-14 RANCH	—	—	—	—	FP-11/87	—	WGRS-MINI-4030	—	—	—	—	—	—	—	—
MINI-THIRTY	—	—	—	—	FP-11/87	—	WGRS-MINI-4030	—	—	—	—	—	—	—	—
NO. 1-B	—	—	—	—	FP-RSS	—	—	7/16"-312N	—	—	—	—	—	—	—
44R	SM-88	O-M	11-12	—	FP-RU	5D-RU	WGRS-44	.450M	.570M	WGOS-M-3/16	—	.538M	—	QD-RAS	—
SAVAGE															
99C	SM-99	J-K with sub-base	18-20 with sub-base	—	FP-99S	—	—	3/8"-312N	—	WGOS-M-3/16	—	3/8"-312N	—	QD-TBM	—
110 G	SM-70	D-F	4L-16	—	FP-110	—	—	7/16"-312N	—	WGOS-M-5/16	—	7/16"-312N	—	QD Loop Set	—
110 GL	SM-110L	D-F	4L-16	—	FP-110	—	—	7/16"-312N	—	WGOS-M-5/16	—	7/16"-312N	—	QD Loop Set	—
170	SM-52/56	A-B	1-2	—	FP-740AP	5D-760N	WGRS-742	3/8"-312N	3/8"-375N	—	WDOS-3/8	—	9/32"-312N	QD Loop Set	—
340	SM-340	—	—	—	FP-340	—	—	.406M	—	—	WDOS-1/4	—	.343M	QD-SS	—



Williams Gun Sight Company
 "On the Range"
 7389 Lapeer Rd.
 P.O. Box 329
 Davison, MI 48423

1-800-530-9028
 Fax: (810) 658-2140
 www.williamsgunsight.com

BULK RATE
 U.S. POSTAGE
 PAID
 DAVISON, MICH.
 PERMIT NO. 20

©2006 — WILLIAMS GUN SIGHT COMPANY, DAVISON, MI

WILLIAMS ACCESSORY CHART

MODEL	SCOPE MOUNTS				RECEIVER SIGHTS			FRONT SIGHT COMBINATION WITH RECEIVER SIGHT		FRONT SIGHT COMBINATION WITH OPEN SIGHT		SWIVEL SET	COMMENTS		
	SIDE MOUNT	SIGHT THRU	STREAM-LINE MOUNT	DOVETAIL MOUNT	FP	SD	WGRS	WITH FP/SD	WITH WGRS	WGOS	WDOS			WITH WGOS	WITH WDOS
WEATHERBY															
MARK-V/RH	SM-70	D-E	4-5	—	FP-98	SD-JEMS	WGRS-700	7/16"-3/12N	7/16"-3/12N	WGOS-S-3/8	—	7/16"-3/12N	—	QD Loop Set	
MARK-V/LH	SM-110LH	D-E	4-5	—	FP-98	SD-JEMS	WGRS-700	7/16"-3/12N	7/16"-3/12N	WGOS-S-3/8	—	7/16"-3/12N	—	QD Loop Set	
VANGUARD VGX	SM-70	D-E	4-5	—	FP-70AP	SD-70	WGRS-700	7/16"-3/12N	7/16"-3/12N	WGOS-M-3/8	—	7/16"-3/12N	—	QD Loop Set	
VANGUARD CLASSIC I	SM-70	D-E	4-5	—	FP-70AP	SD-70	WGRS-700	7/16"-3/12N	7/16"-3/12N	WGOS-S-3/8	—	7/16"-3/12N	—	QD Loop Set	
VANGUARD CLASSIC II	SM-70	D-E	4-5	—	FP-70AP	SD-70	WGRS-700	7/16"-3/12N	7/16"-3/12N	WGOS-M-3/8	—	7/16"-3/12N	—	QD Loop Set	
XXII	—	G-G	7-7	1-Piece	FP-98/100	—	WGRS-54	3/8"-3/12N	7/16"-3/4SN	WGOS-S-7/16	—	3/8"-3/4SN	—	QD Loop Set	
WINCHESTER															
70 SPORTER	SM-70	D-C	4-3	—	FP-70AP	SD-70	WGRS-70	1/2"-290N	1/2"-290N	WGOS-Special-3/8	—	1/2"-290N	—	QD Loop Set	
70 FEATHERWEIGHT	SM-70	D-C	4-3	—	FP-70AP	SD-70	WGRS-70	1/2"-290N	1/2"-290N	WGOS-Special-3/8	—	1/2"-290N	—	QD Loop Set	
70 VARMINT	SM-70	D-C	4-3	—	FP-70AP	SD-70	WGRS-70	7/16"-290N	7/16"-290N	WGOS-L-5/16	—	7/16"-290N	—	QD Loop Set	
70 LIGHTWEIGHT	SM-70	D-C	4-3	—	FP-70AP	SD-70	WGRS-70	1/2"-290N	1/2"-290N	WGOS-Special-3/8	—	1/2"-290N	—	QD Loop Set	
70 SUPER GRADE	SM-70	D-C	4-3	—	FP-70AP	SD-70	WGRS-70	1/2"-290N	1/2"-290N	WGOS-Special-3/8	—	1/2"-290N	—	QD Loop Set	
RANGER BOLT ACTION	SM-70	D-C	4-3	—	FP-70AP	SD-70	WGRS-70	1/2"-290N	1/2"-290N	WGOS-Special-3/8	—	1/2"-290N	—	QD Loop Set	
94 SIDE EJECT	SM-94/36	—	21-22	—	FP-94SE	SD-94SE	—	.312M	—	—	—	—	—	QD-TBM	Use SM-71 when installing both scope & receiver sight
94 BIG BORE S.E.	SM-94/375	—	21-22	—	FP-94BSE	—	—	.312M	—	—	—	—	—	—	Use SM-71 when installing both scope & receiver sight
94 TRAPPER S.E.	SM-94/36	—	21-22	—	FP-94SE	SD-94SE	—	.375M	—	—	—	—	—	—	Use SM-71 when installing both scope & receiver sight
94 RANGER S.E.	SM-94/36	—	21-22	—	FP-94SE	SD-94SE	—	.538M	—	—	—	—	—	—	Use SM-71 when installing both scope & receiver sight
94 TOP EJECT	SM-94/36	—	—	—	FP-94/36	SD-94/36	—	.312M	—	—	—	—	—	—	Use SM-71 when installing both scope & receiver sight
94 BIG BORE T.E.	SM-94/375	—	—	—	FP-94/375	—	—	.312M	—	—	—	—	—	—	Use SM-71 when installing both scope & receiver sight
9422/9422M	—	—	—	2-Piece	FP-GR	—	WGRS-54	.343M	.450M	—	—	.343M	—	—	