

Supporting American Freedom Since 1975



**RETAIL
CATALOG
2004**

**RETAIL
CATALOG
2004**



OLYMPIC ARMS, INC.

Meeting the Demands of the 21st Century

624 OLD PACIFIC HWY SE

OLYMPIA, WA 98513

800-228-3471

WWW.OLYARMS.COM

Warranty

Our goal at Olympic Arms is to lead the industry in customer service and satisfaction. For this reason, we are proud to offer the most comprehensive factory warranty of its kind.

We will warranty all parts and products produced by Olympic Arms Inc., against any and all manufacturer's defects in materials and workmanship, which affect the satisfactory operation of the parts or products in question, for the lifetime of the parts or products to the original owner. This warranty is non-transferable.

Satisfaction Guarantee

Above and beyond that, we guarantee complete customer satisfaction. If you are not completely satisfied with the purchase of any Olympic Arms product for any reason, simply return it to us within 60 days for a replacement, credit, or full refund of the original purchase price. If you purchased your product directly from Olympic Arms, simply return the product with a copy of the original invoice to qualify. If your purchase was made through one of the thousands of Olympic Arms retailers, the retailer has the option to return it to Olympic Arms for a full refund as well. Olympic Arms cannot dictate the in store policies of all of its retailers. Please check with your retailer for their policy before purchasing.

Olympic Arms' liability is limited to repair or replacement of only those parts determined to be defective by the factory, as necessary to provide the customer with a properly operating finished product. We assume no liability for accidental or consequential damages. The following items are specifically excluded from coverage under this warranty.

- A. Normal wear of the protective finishes and of all metal or plastic parts;
- B. Damage or malfunction resulting from accident, negligence, misuse or unauthorized repair or alteration;
- C. Damage or malfunction resulting from barrel obstructions;
- D. Damage or malfunction resulting from use of other than factory SAAMI spec. brass cased, new production ammunition.
- E. Damage resulting from the use of *ANY* imported, handloaded, reloaded, or factory re-manufactured ammunition.
- F. Any finished products (completed rifle or pistol kits, uppers, lowers, barrel units, etc.) that are *NOT* assembled at the factory, or are assembled using imported used parts.
- G. Any damage caused to Olympic Arms parts or components during assembly by any other individual, organization, company or entity other than Olympic Arms, Inc.

Table of Contents

Dealer Distributor Program	Inside Front Cover
Warranty	1
Open Letter From Olympic Arms CEO	2
PCR/AR Style Rifles	
PCRs (Rifles, carbines, pistols)	3-24
NEW AirSoft Products	25
PCR Upper Conversion Units	26-27
Pistol Caliber Conversions & parts	28-30
PCR/AR Parts	31-42
NEW Prop-Guns & Training Aids	43
AR Exploded View, Parts List	44-45
Gunsmithing Tools & Manuals	46-48
AR Barrels	50 & 52-53
NEW PCR Parts Kits	51
Logo Items	49
MaxHard & Blak-Tac info	
Olympic Arms and SPW 1911 pistols	56-62
1911 Parts Slides & Frames	63-67
Westerner Series	59
Blak-Tac Matchmaster	62
1911 Exploded View and Parts List	50
Pistol Barrels	68
Ultramag Magnum Bolt Actions	69-70
Whitney Wolverine	71-72
Dealer Distributors & Industry Partners .	Inside back cover

Ordering Instructions

We pride ourselves on having the most courteous and knowledgeable sales staff in the industry. Our offices are open Monday through Friday, from 7:00 a.m. to 4:30 p.m. to take your calls.

How to Order

Retail Customers: A retail customer is any individual who is not an FFL dealer. Retail customer orders are accepted by telephone, mail, fax, or E-mail. All orders must include:

1. Full name and shipping address. *No orders with Post Office Box addresses will be accepted.*
2. Daytime/business phone, and fax numbers if applicable.
3. Method of payment arrangements.
4. Complete description of the products ordered to include item/stock numbers.

NOTE: *No dealer order will be accepted by anyone other than those people named on the FFL, or those persons designated by the Licensee. No exceptions will be made.*

Shipping and Handling Fees

All shipping and handling fees are billed based on the total dollar amount of each invoice. Each separate box required for shipping, will be shipped via a separate invoice. S&H charges are taxable to Washington State residents. S&H Charges are as follows:

\$1.00- \$99.00	\$7.95
\$100.00- \$499.00	\$14.95
\$500.00-\$1000.00	\$20.00
\$1001.00 & UP	\$27.00
COD	Add \$6.25 per invoice

Methods of Payment

We will accept C.O.D., credit card, or pre-paid orders. All C.O.D. orders will be shipped on a certified-funds-only basis. To receive a C.O.D. check O.K. status, you must first file a bank reference with our accounting department. All C.O.D. check O.K. accounts will be approved at that time for all future shipments (pending approval by the accounting department).

We accept American Express, Discover Card, Master Card and VISA for credit card orders. Your account will not be charged until the item is shipped.

Pre-paid orders are accepted. However, orders paid by personal or company checks may be held until the funds clear the bank. This process could delay your order as much as 10-14 days. All orders from within the state of Washington will be charged 8% sales tax, unless a Washington State Department of Revenue resale certificate is on file. **Sorry, but no open accounts are offered.**

Returns

All returns are to be sent to:

**Olympic Arms, Inc.
Att: Returns & Repairs
624 Old Pacific Highway SE
Olympia, WA 98513**

Please make sure that you include your personal and company name, a return address (no P.O. box numbers, please), a day-time telephone number, and a letter of explanation as to what the problem might be, along with a copy of the original invoice.

NO CLASS III RETURNS OR REPAIRS CAN BE ACCEPTED WITHOUT PRIOR NOTIFICATION AND PROPER ATF TRANSFER. All class III items sent to Olympic Arms without prior knowledge and the required ATF paperwork will be returned *immediately* to the sender.

Warranty Repair

All returns for Warranty Repair are to be shipped to the above address. Determination as to whether the problem with the returned item is covered under the factory warranty will be made after it is inspected by the technical staff of Olympic Arms, Inc. Our technical staff is the only department qualified to make this determination. Please do not make assumptions.

Restocking Fee

All refused or returned shipments without prior authorization are subject to payment of all shipping charges incurred by Olympic Arms, as well as a 15% re-stocking fee. Please be sure to call to determine if a Return Authorization number is required *before* you return any product to us. Olympic Arms proudly manufactures weapons for law enforcement departments and LE individuals, as well as government and military organizations around the world. All federal laws apply to the legal transfer of such weapons. Please read the following information carefully. If you have any further questions with regards to LE sales, please feel free to contact us during regular business hours.

Open Letter From Olympic Arms:



In 1776 when this nation began its quest for freedom, the most important person in the village was not the mayor, or civic leaders. It was not the dry goods vendor or even the Parson. It was the blacksmith. And why? Because the blacksmith, with his ability to manufacture firearms, as well as fix and repair existing weapons, had the unique ability to allow a man to not only put food on the table, but also to defend himself, his family and his home from any aggressor be they four-legged beasts seeking to steal your livestock, or two-legged beasts seeking to steal your freedom and independence.

Olympic Arms functions in many ways the just as the blacksmith did over 200 years ago. It was the blacksmith, through first hand experience and dealing with actual customers who used his product, that was able to meet their every need through alternative design and product innovation. That's what we do best. alternative design and product innovation have always been our specialties.

Being a true manufacturer, just in the same way as the blacksmith was 200 years ago, we can provide a product that is innovative, of high quality, and on the cutting edge of design and technology to meet our customers needs and desires. We have been doing this for almost 30 years now, and we continue to do it today.

This past year has been an exciting one. We continue to grow and expand. We have added 3 more new state-of-the-art CNC machine stations in 2003, and our growth just seems to keep going. Our product research and department department, headed by Corporate Vice President Brian Schuetz who also happens to be my son. He is assisted by 20 year employee and Master Gunsmith Steve Houseman, and they have been kept busy to say the least. The short list of new products developed in 2003 included two more world firsts!

The first AR15 based rifles chambered in the new *Winchester Super Short Magnum*® cartridges are now shipping. The worlds first 30 Carbine Caliber AR15 is now out (which by the way was developed for a requirement of the Israeli Defense Forces). We continue to lead the industry in product upgrades and technology with things like Maxhard and Blak-Tac.(see page 54 & 55).

Rest was something that the local blacksmith didn't get much of. Always on demand when his help was needed, we have done the same for our military, our Special Forces Groups, as well as our nations civilians for 29 years and counting. As long as there's work to do, we won't rest either.

**Robert C. Schuetz
President/CEO
Olympic Arms, Inc.**

The PCR-1P

Premium Grade Ultramatch Rifle

Premium Quality, Premium Performance.



PCR-1P
\$1,559⁰⁰

Optics not included

Building on the reputation of “the most accurate AR15 target rifle ever made” (SWAT Magazine), Olympic Arms now offers the PCR1P Premium Grade rifle. This rifle incorporates all the same features as the truly famous Ultramatch rifle, but adds a host of options and upgrades as standard. The PCR-1P is the supreme leader in technological advances that are far ahead of our competitors, and are only available through Olympic Arms. Astounding accuracy and ultimate reliability are the norm with this model. Expect sub 1/2 m.o.a. right out of the box.

PCR-1P SPECIFICATIONS AND STANDARD FEATURES:

Maxhard® Picatinny Flat-top upper receiver.

Maxhard® Premium forged A2 lower receiver.

Premium Receiver Logo

Williams Set Trigger

Ergo® brand Tactical Pistol Grip

Harris® Brand Bi-Pod (S-series available)

Barrel: Choice of 20” or 24” Broach-cut Ultramatch Bull barrel

Twist Rate: Choice of 1x10” or 1x8”

ERing one piece gas ring

EXring Polymer extractor buffer

ESpring Ejector spring

AC4 Pneumatic Recoil Buffer

20” or 24” Ultramatch Bull Barrel

Blak-Tak Armour Bolt Carrier Assembly

Premium Logo. The Olympic Arms Premium Series (M4 Premium and PCR-SMP Premium soon to be released) are all based on the Premium lower receiver. As shown below, the Premium Grade lower receiver is emblazoned with a custom logo, and carries the model designation of “PREM” to indicate to all that this is a Premium Grade receiver.



Premium Receivers are **ONLY** available with complete rifles and are not sold separately.

Maxhard Upper and Lower Receivers.

Why are the Premium receivers better? Good question. They are not only different than our standard AR receivers, they are truly better because they are treated to Olympic’s proprietary heat-bath process called Maxhard. This treatment hardens the mil-spec 7076 T6 aluminum forgings from 2-3 on the Rockwell “C” scale, to 20c! This means each receiver, while still aluminum has mild steel strength! Maxhard means less wear in critical areas like the hammer and trigger pins, takedown and pivot pin areas. Steel strength, with lightweight aluminum.



Each Maxhard® upper is individually stamped to show it’s quality.

NEW FOR 2004 NEW FOR 2004 NEW

The PCR-SMP
Premium Grade Service-Match Rifle
Premium Quality, Premium Performance.



\$1,613.00

Turner Saddlery leather competition sling included!
 Bob Jones® NM
 Interchangeable aperture rear sight system standard!

Continuing on in the tradition of Olympic Arms *Premium* line, the much anticipated **PCR-SMP** is now available. Released on a limited basis last year, the **SMP** has been dazzling its owners beyond their expectations. The **SMP** comes standard with Maxhard upper and lower receivers giving maximum strength and rigidity to the aluminum forged receivers. It is also standard with a 20" Ultramatch barrel assembled with a 1x8" twist standard. This barrel is unique to the **SMP** model as the front sight base is attached via set screws for perfect "TDC" front sight base alignment, and has no taper pin holes. The barrels on the **SMP** model are broach-cut to perfection from 416 SS magna-fluxed bar stock and are manufactured here in our factory from scratch, and finished by hand cutting custom "CMP" chambers using reamers manufactured especially for Olympic Arms by our friends and industry partners at Clymer®. Also includes the AC4 pneumatic recoil buffer. The AC4 buffer reduces recoil and muzzle climb (which increases second shot sight acquisition, an important part of high power and CMP shooting), as well as takes away the annoying spring noise found in all other AR15 style rifles. Full of exclusive features, and all at a fair price.

- Maxhard forged A-2 upper receiver. *Oly Exclusive!*
- Maxhard Premium forged A2 lower receiver. *Oly Exclusive!*
- Premium Receiver Logo
- 2-Stage CMP legal custom trigger.
- Blak-Tak Armour Bolt Carrier Assembly *Oly Exclusive!*
- Barrel: 20" SUM Broach-cut Ultramatch Super-heavy barrel with a Twist Rate of 1x8". *Oly Exclusive!*
- Chambered using customClymer® CMP reamer *Oly Exclusive!*

- ERing one piece gas ring
- EXring Polymer extractor buffer
- ESpring Ejector spring
- AC4 Pneumatic Recoil Buffer *Oly Exclusive!*
- Turner Saddlery® Competition Sling
- GI Style Pistol Grip
- Protective Sight covers, mag-well block and range safety flag included with each rifle!

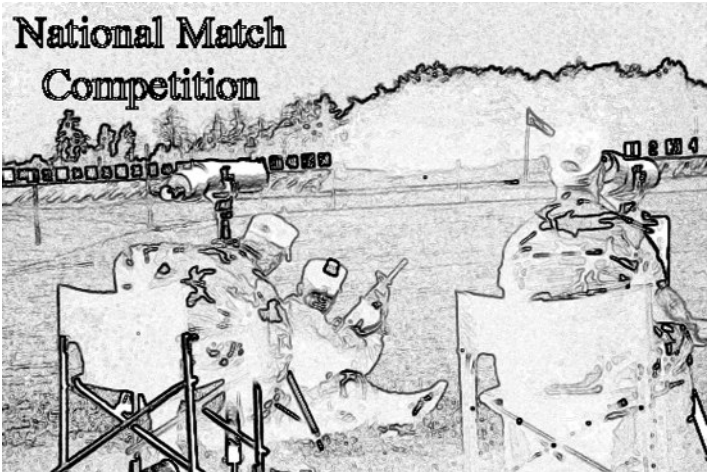

"Out of the box, and go to the range. All you have to do is zero your sights and load the rifle. This is the most complete CMP style service rifle package on the market. With the Bob Jones' sights, 2-stage trigger and Turner sling all standard, it saves my customers time and money by having everything you need to compete all in on purchase. Custom exclusive features like the Maxhard receivers and the AC4 pneumatic recoil buffer make a difference, and really make this rifle one of a kind."

Dick Tatem; Owner of Stoneagle
 Newport, NH
 Top 10 Oly Arms Dealer Distributor
 for 3 years. <http://www.stoneagle.com/>

NEW FOR 2004 NEW FOR 2004 NEW

PCR-SM



PCR-SM
\$1,099⁰⁰

MSRP: \$1,099.00

PCR-SMUR (upper receiver only) **\$750⁰⁰**

PCR-SERVICE MATCH

A CMP legal Service Match Competition Rifle. The Service Match has our famous 20" stainless steel broach-cut Ultramatch™ barrel. Also as standard features are 1/4 m.o.a. adjustable national match rear sight system, and a factory-tuned trigger pull, smoothed out to a crisp break at about 41/2-5 lbs. Rounding out the rifle is the use of a Service Rifle legal free-floating handguard assembly. Guaranteed to group sub 1" group or less at 100 yards, or your money back!

Receivers: 7075 T6 Aluminum Forgings; CNC Machined to exacting tolerances by Olympic Arms. *Not machined by a subcontractor.*

Finish: Black Matte Hard Anodized receivers, parkerized steel parts, and black oxide stainless steel barrels (mil-spec or better)

Action: Gas operated. Semi-auto.

Caliber/Chambering: SAAMI minimum .223 Remington. See SAAMI for full details at www.saami.org

Sights: National Match 1/4 moa adjustable rear, elevation adjustable post front

Barrel: 20" Ultramatch (SUM) super-heavy (.980" diameter under handguard) with black oxide finish.

Rifling: Precision broach-cut, magna-fluxed 416 stainless steel. Manufactured in-house by Olympic Arms, Inc.

Bore: NOT chrome lined, for superior accuracy and longer life (80,000 rounds plus)

Twist Rate: Your choice of 1x8" with 1x10"

Muzzle: Grooved for optional factory Olympic Arms muzzle brake

Capacity: Shipped with Post-Ban magazine. High capacity legal pre-ban magazines

Length: 39.5"

Weight: 8.75 lbs.

Oly Fact!

Did you know that Olympic Arms pioneered the 1x8 twist barrel now used by most match shooters? Long before the AR15 type weapons were widely accepted in the service rifle circuit, Olympic Arms produced a 1x8 twist barrel. Instrumental in the advancement of the accuracy of the AR15 rifle system, Olympic's 1x8 twist and broach-cut barrels have paved the way for the AR15 to be the choice in service rifle competitions nationwide. As most service rifle shooters will tell you, "The mouse is now roaring!"

As you just read in the note above, the mouse truly is roaring, and in the hands of California's **Coalinga Rifle Club**, they roared right into second place in the NTIT or "Rattle Battle" competition at the 2003 Camp Perry National Matches winning a much coveted Silver Medal! Keep in mind that this team beat out several scores posted by our Armed Forces teams in the process! The 2003 the Coalinga NTIT Team was anchored by these four competitors: (kneeling) siblings Samantha (who only dropped one shot in the whole match!)& Ty Cooper (since recruited by the US Army Marksmanship Unit) both Jr's, and (standing l-r, also siblings) Ed and Robert Taylor II. Keep an eye on the Coalinga team during next year's National Matches. They'll be the ones with the big Olympic Arms logo's on their shirts and Olympic Arms flag by their lane!



PCR-1 ULTRAMATCH RIFLE

OFTEN COPIED: NEVER EQUALED!

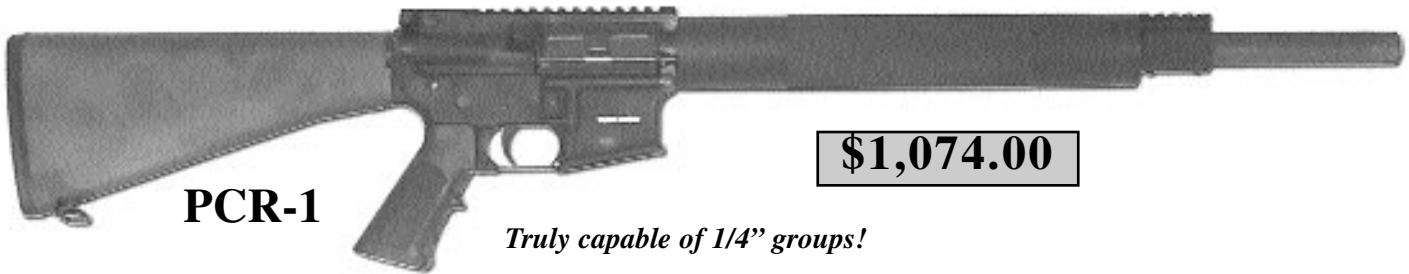

PCR-1

\$1,074.00

Truly capable of 1/4" groups!

If it is accuracy you seek, the PCR-1 is the "1" to get. Equipped with our famous **Ultramatch** broach cut stainless steel barrel and chambered with minimum SAAMI spec .223 caliber Match-Grade reamers from **Clymer®** for optimum accuracy potential, we **guarantee** you that any one of the PCR-1/2/3 models will shoot 1" or better right out of the box (with the proper ammo), or we'll buy them back! **That is a guarantee you can't get anywhere else at any price.** As a matter of fact and pride, we expect that the PCR-1 will shoot 1/4" groups or smaller with the right load/bullet/barrel combinations. **SWAT®** magazine has called the Ultramatch/PCR-1 "**The most accurate AR target rifle ever made**". Simply put, this rifle will not disappoint even the most discriminating shooter. Looking for more great news? The PCR-1 now comes standard with a Bull barrel and Picatinny gas block for no extra charge!

Receivers: 7075 T6 Aluminum Forgings; CNC Machined to exacting tolerances by Olympic Arms. *Not machined by a subcontractor.*

Finish: Black Matte Hard Anodized receivers, parkerized steel parts, and black oxide stainless steel barrels (mil-spec or better)

Action: Gas operated. Semi-auto.

Caliber/Chambering: SAAMI minimum .223 Remington. See SAAMI for full details at www.saami.org

Sights: picatinny flat-top upper, with picatinny gas block.

Barrel: 20" Ultramatch (SUM) super-heavy (.980" diameter under handguard) with black oxide finish.

Rifling: Precision broach-cut, magna-fluxed 416 stainless steel. Manufactured in-house by Olympic Arms, Inc.

Bore: NOT chrome lined, for superior accuracy and longer life (80,000 rounds plus)

Twist Rate: 1x10 or 1x8"

Muzzle: Grooved for optional factory Olympic Arms muzzle brake

Capacity: Shipped with Post-Ban magazine. High capacity legal pre-ban magazines

Length: 39.5"

Weight: 8.6 lbs.

Oly Fact!

Did you know that it was Olympic Arms that innovated the aluminum free-floating handguard, as well as the flat-top upper receiver? Olympic Arms was the first manufacturer to make both of these features available to the public. These, along with many other product innovations over the years have become common place in the industry. Why is this possible? Why is Olympic Arms so far ahead of other manufacturers in product development? Simple; by having our own in house R&D department, and the ability to manufacture what we develop, it becomes easy to lead the way! We may not have made all of the AR's you use, but chances are, we have made all of the AR's you use better!

K6 (PCR-1 Upper receiver only) \$630⁰⁰



The K6 is the fully assembled top half of the PCR-1 rifle. By adding this upper to your assembled GI style lower receiver, you too can have accuracy that was never before achievable! The K6 is available with all of the options listed above (except the WS set trigger option). Your choice of twist rates in 1x10 (52-68/69gr) or 1x8 for the heavier bullets (75-80gr). **NOW STANDARD WITH A 20" BULL BARREL**!**

****New for 2003: the K6 is now standard with the 20" SUM (Stainless UltraMatch) BULL barrel. Because of this change, the K6 is also now standard a bi-pod stud installed, and a picatinny gas block.**

PCR-2 and PCR-3 MULTIMATCH VARIANTS



PCR-3 \$959⁰⁰

Shown with optional Bull Barrel

PCR-2



Same features as the PCR-3, but with the classic A2 sight system.

THE PCR-3 is the miniature PCR-1. The only difference is the shorter 16" barrel assembly. Able to compete side by side with PCR-1 model shot for shot out to 300 meters or so. Shorter, and more maneuverable, the Multimatch rifles in the PCR-2 and 3 models are top choices for short to medium range varmint and target shooting, as well as for domestic law enforcement agencies as anti-personnel/sniper weapons when space in the squad car or at the scene is at a premium, yet surgical accuracy is required.

THE PCR-2 is the PCR-3 with the standard A2 sight system. For those people accustomed to the looks and feel of the military A2 sighting system and carry handle, but requiring far superior accuracy, this is the proper choice. Again, starting with the stainless steel Ultramatch broach-cut rifled barrel (only available from Olympic Arms), this rifle will shoot as well as any other manufacturer's match-grade 20" rifles within it's ballistic limitations.

STANDARD FEATURES:

- 416 Stainless Steel *Ultramatch*® Broach-Cut barrel w/SAAMI .223 match chamber (1x10" or 1x8" twist, air-gauged)
- Free-Floating 2-Piece Aluminum Handguard System (FIRSH Rail Handguard also available)
- Factory Trigger Job (smooth, crisp, 4.5 lb +/- trigger pull)
- Hand Matched Receivers for excellent more than hand-tight fit

PCR-2	16" barrel, A2 upper	\$959 ⁰⁰
PCR-2A3	w/detachable carry handle	\$1,054 ⁰⁰
PCR-3	16" barrel, flat top	\$959 ⁰⁰
PCR-2UR	(upper receiver unit only)	\$586 ⁰⁰
PCR-3UR	(upper receiver unit only)	\$586 ⁰⁰

OPTIONS:

1x8	1x8" Twist	N/C
Bull	Bull Barrel	\$60 ⁰⁰
F	Fluted Barrel (includes custom shop fee)	\$149 ⁰⁰
A3	A-3 Detachable Carry Handle	\$95 ⁰⁰
B	Harris Bi-Pod	\$78 ⁰⁰
B2	S-Series Harris Articulating Bi-Pod	\$86 ⁰⁰
ST	Bi-Pod Stud only	\$24 ⁰⁰
TG	Tactical Pistol Grip	\$60 ⁰⁰
WS	Williams Set Trigger	\$166 ⁰⁰
RHG	FIRSH Rail handguard	\$78 ⁰⁰

Oly Fact!

Olympic Arms was the first AR15 style rifle manufacturer to offer the 1x8 twist barrel. Oly was also the first, and still the only AR15 style rifle manufacturer to offer a true broach-cut barrel in the .224 caliber bore. Others make single point cut barrels, but we provide a true broach cut bore in that all 4 lands and grooves are cut all at the same time, not one at a time. This allows us to maintain bore consistency up to 5 1 millionths of an inch (.0000050")! US Military standards require a National Match barrel to be a broach-cut bore with 4 lands and grooves. Does your barrel have this? If not, give us a call!

PCR-4



PCR-4

The industry standard with a 4140 chromemoly match-grade button rifled barrel, A2 upper, A2 handguards, A2 stock. This is as close to the M16A2 in a civilian variant that you can get, only much better.

PCR-4A3

The same great rifle with the optional flat-top upper and detachable carry handle. This platform ads versatility unavailable with the standard A2 upper.

Receivers: 7075 T6 Aluminum Forgings; CNC Machined to exacting tolerances by Olympic Arms. *Not machined by a subcontractor.*

Finish: Black Matte Hard Anodized receivers, parkerized steel parts, and black oxide stainless steel barrels (mil-spec or better)

Action: Gas operated. Semi-auto.

Caliber/Chambering: 5.56 NATO caliber. See SAAMI for full details at www.saami.org

Sights: A-2 adjustable rear sight, elevation adjustable post front

Barrel: match-grade 20" 4140 chromemoly steel standard.

Rifling: Precision button-rifled for maximum accuracy in standard heavy match-grade barrel

Bore: NOT chrome lined, for superior accuracy and longer life (80,000 rounds plus)

Twist Rate: 1x9"

Muzzle: Grooved for optional factory Olympic Arms muzzle brake

Capacity: Shipped with Post-Ban magazine. High capacity legal pre-ban magazines

Length: 39.5"

Weight: 8.6 lbs.

PCR-4 OPTIONS

SS	Stainless Steel barrel	\$4200
+F	Fluted barrel	\$14900
MB	Post-Ban Muzzle Brake	\$2400
FT	Flat-Top upper	N/C
	(available with shaved standard front site base [add \$12.00], or picatinny gas block.)	



COMPLETE UPPER RECEIVER ASSEMBLY ONLY:

PCR-4UR \$44900

Oly Fact! "Mil-Spec"; The Reality.

We get asked this question a great deal; "are Olympic Arms PCR style rifles mil-spec?" The simple answer is no, but neither are those AR style rifles made by any manufacturer except those made in select fire, 3 round burst configuration. That is what "mil-spec" requires. Select fire specific parts such as bolts, selectors, hammers, triggers, firing pins and even the lower receiver itself are made differently, in other words, to a different "spec". For that reason, no AR15 style rifles manufactured for civilian use are "mil-spec".

The real question should be, "is your product mil-spec quality?", and to that the answer is **YES**. Olympic Arms rifles and/or components are in service with individuals in such groups as the US Army Special Forces, US Army Rangers, US Marshal's Service, USMC Marksmanship Unit, US Army MTU's, the Secret Service, the US Navy Seals, and the FBI. Additionally, we have provided service weapons for foreign nations such as Italy, Israel, the Phillipines and more.

Having been in the business for 27 years now, we have a pretty good idea of how to make a quality weapon, be it for home defense, marksmanship practice, or to defending the nations and free citizens of the world, you can bet Olympic will be there!

8528793

NEW FOR 2004 NEW FOR 2004 NEW

GI-20



Only \$749.00

The big brother to the GI-16, and also new for 2004, the GI-20 is a throw-back rifle with an A-1 rear sight system. But, keep in mind that this modernized "A-1" gun still has an A-2 lower, and all of the A-2 features on the upper except the sights. Built right in to the forged upper receiver are the forward assist and brass deflector.

Standard with a 20" full heavy barrel (.980" under the handguards) that is button rifled with a 1x9 twist, this rifle is heavy duty and ready for action. Expect the same excellent accuracy from this rifle as you would a PCR-4 model, but simply less adjustability in the rear sights. Priced competitively for the budget consumer, this is the least expensive 20" barreled AR on the market. Don't forget the lifetime warranty!

GI-20 Specifications AND STANDARD FEATURES

Receivers: 7075 T6 Aluminum Forgings; CNC Machined to exacting tolerances by Olympic Arms. *Not machined by a subcontractor.*

Finish: Black Matte Hard Anodized receivers, parkerized steel parts, and black oxide stainless steel barrels (mil-spec or better)

Action: Gas operated. Semi-auto.

Caliber/Chambering: 5.56 NATO caliber. See SAAMI for full details at www.saami.org

Sights: A-1 adjustable rear sight, elevation adjustable post front

Barrel: match-grade 20" 4140 chromemoly steel standard.

Rifling: Precision button-rifled for maximum accuracy in standard heavy match-grade barrel

Bore: NOT chrome lined, for superior accuracy and longer life (80,000 rounds plus)

Twist Rate: 1x9"

Muzzle: Grooved for optional factory Olympic Arms muzzle brake

Capacity: Shipped with Post-Ban magazine. High capacity legal pre-ban magazines

Length: 39.5"

Weight: 8.4 lbs.

GI-20 UPPER RECEIVER ONLY:



GI-20UR

\$432⁰⁰

This unit is sold as a complete unit only. It is assembled, headspaced and test fired at the factory and comes with a full lifetime warranty against manufacturers defects.

"... Thank you for making the absolute best AR variant in existence, I mean that very sincerely as I regularly shoot with members of my counties(sic) SWAT team. They are always exceedingly impressed with the fact that my 11.5in bbl will without question shoot M.O.A. at 100yds. Not bad eh? Keep up the phenomenal work."

Respectfully,

Sean Brown

NEW FOR 2004 NEW FOR 2004 NEW

PCR-5

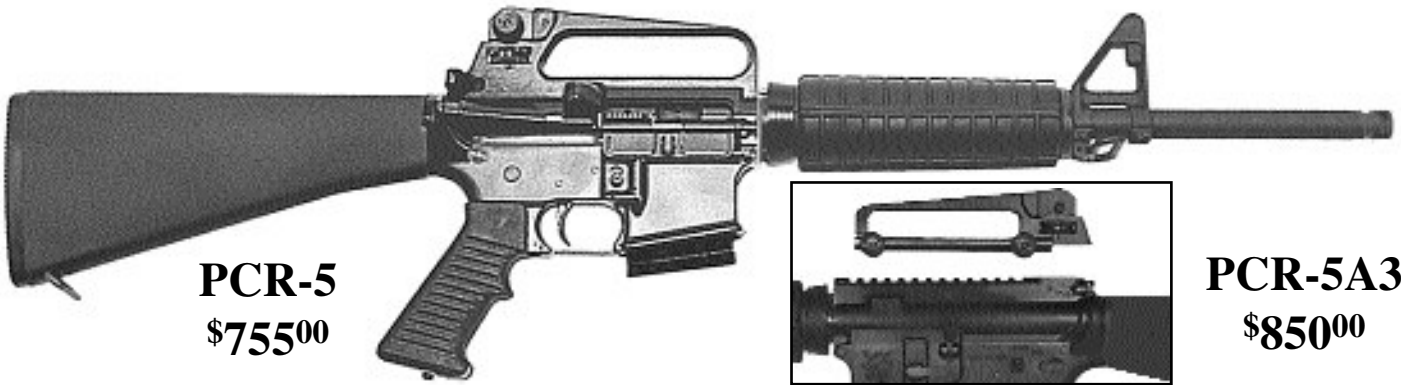

PCR-5
\$755⁰⁰

PCR-5A3
\$850⁰⁰

PCR-5 This is a great little 16" carbine that will offer fun for a lifetime. Because of the Match-Grade button rifle barrel that comes standard on all PCR models, PCR-5 will provide surprising accuracy often out-performing other manufacturers 20" HBAR models! This carbine is rugged and accurate, yet reliable enough to allow you the comfort and security of using it for personal and/or home defense. The PCR-5 graces the trunks of hundreds of our nations police patrol cars, and comes with 1 post-ban mag, sling and hard case. Standard in 5.56 NATO, this handy little package is also available in 4 different pistol calibers.

Receivers: 7075 T6 Aluminum Forgings; CNC Machined to exacting tolerances by Olympic Arms. *Not machined by a subcontractor.*

Finish: Black Matte Hard Anodized receivers, parkerized steel parts, and black oxide stainless steel barrels (mil-spec or better)

Action: Gas operated. Semi-auto.

Caliber/Chambering: 5.56 NATO caliber. See SAAMI for full details at www.saami.org

Sights: A-2 adjustable rear sight, elevation adjustable post front

Barrel: match-grade 16" 4140 chromemoly steel standard.

Rifling: Precision button-rifled for maximum accuracy in standard heavy match-grade barrel

Bore: NOT chrome lined, for superior accuracy and longer life (80,000 rounds plus)

Twist Rate: 1x9"

Muzzle: Grooved for optional factory Olympic Arms muzzle brake

Capacity: Shipped with Post-Ban magazine. High capacity legal pre-ban magazines

Length: 34"

Weight: 7.0 lbs.



ALSO AVAILABLE IN PISTOL CALIBERS (SEE PAGE 20)

PCR-9 9mm caliber \$834⁰⁰
sold with 32 round converted Sten mag.

PCR-10 10mm \$834⁰⁰
sold with 10 round converted Uzi mag.

PCR-40 40 S&W caliber \$834⁰⁰
sold with 10 round converted Uzi mag.

PCR-45 45 ACP caliber \$834⁰⁰
sold with 10 round converted Uzi mag.



**COMPLETE UPPER RECEIVER ASSEMBLY ONLY:
PCR-5UR \$436⁰⁰**

NEW FOR 2004 NEW FOR 2004 NEW

GI-16



Only \$699.00

Receivers: 7075 T6 Aluminum Forgings; CNC Machined to exacting tolerances by Olympic Arms. *Not machined by a subcontractor.*

Finish: Black Matte Hard Anodized receivers, parkerized steel parts, and black oxide stainless steel barrels (mil-spec or better)

Action: Gas operated. Semi-auto.

Caliber/Chambering: 5.56 NATO caliber. See SAAMI for full details at www.saami.org

Sights: A-1 adjustable rear sight, elevation adjustable post front

Barrel: match-grade 16" 4140 chromemoly steel standard.

Rifling: Precision button-rifled for maximum accuracy in standard heavy match-grade barrel

Bore: NOT chrome lined, for superior accuracy and longer life (80,000 rounds plus)

Twist Rate: 1x9"

Muzzle: Grooved for optional factory Olympic Arms muzzle brake

Capacity: Shipped with Post-Ban magazine. High capacity legal pre-ban magazines

Length: 39.5"

Weight: 7.0 lbs.



GI-16UR: \$395.00

The GI-16UR is a fully assembled upper receiver unit that is headspaced and test fired at the factory. Lifetime warranty applies.



NEW FOR 2004 NEW FOR 2004 NEW

NEW FOR 2004 NEW FOR 2004 NEW

OA-93PT



\$1,074.00

Comes standard with the FIRSH handguard and aluminum vertical pistol grip.
That's almost **\$180.00** worth of options included
AT NO ADDITIONAL CHARGE!

This is by far one of the most exciting new products that we have released here at Olympic Arms in many years! Based on the tried and true OA-93 operations system, this post-ban legal carbine has a totally removable stock! (see inset picture below) With collapsible and folding stocks forbidden on semi-autos like the AR-15 style rifle since the 1994 Crime Bill, this is your best, and most exciting alternative! The stock removes via a push button system, and then easily attaches to the side of the FIRSH rail handguard system that comes standard with each OA-93PT. Additionally, to aid in fire control, each carbine package also includes a vertical pistol grip for a more rigid and secure firing position when the stock is removed (shown at right). Definitely something you want to have in your collection, and with the proper ammunition, and excellent choice in a home defense firearm. This rifle is truly like no other!



Shown above with stock detached, and stored on the FIRSH handguard.

Receivers: 7075 T6 Aluminum Forgings; CNC Machined to exacting tolerances by Olympic Arms. *Not machined by a subcontractor.*

Finish: Black Matte Hard Anodized receivers, parkerized steel parts, and black oxide stainless steel barrels (mil-spec or better)

Action: Gas operated proprietary OA-93 system. Semi-auto.

Caliber/Chambering: 5.56 NATO caliber. See SAAMI for full details at www.saami.org

Sights: No fixed sights. Integral flat-top upper receiver rail system standard

Barrel: match-grade 16" 4140 chromemoly steel standard.

Rifling: Precision button-rifled for maximum accuracy in standard heavy match-grade barrel

Bore: NOT chrome lined, for superior accuracy and longer life (80,000 rounds plus)

Twist Rate: 1x9"

Muzzle: Grooved for optional factory Olympic Arms muzzle brake

Capacity: Shipped with Post-Ban magazine. High capacity legal pre-ban magazines

Length: 34.5" with stock; 26.75" without stock.

Weight: 7.95 lbs with stock, 7.0 lbs

Accessories: Package standard with vertical pistol grip and FIRSH rail handguard system.

NEW FOR 2004 NEW FOR 2004 NEW

PLINKER



MSRP: \$599.00

Only \$599⁰⁰

Still, the fastest selling AR15 style rifle in America!

NOTE: A3 option is NOT AVAILABLE with the Plinker.

Receivers: 7075 T6 Aluminum Forgings; CNC Machined to exacting tolerances by Olympic Arms. *Not machined by a subcontractor.*

Finish: Black Matte Hard Anodized receivers, parkerized steel parts, (mil-spec or better)

Action: Gas operated. Semi-auto.

Caliber/Chambering: 5.56 NATO caliber. See SAAMI for full details at www.saami.org

Sights: A-1 adjustable rear sight, elevation adjustable post front

Barrel: match-grade 16" 4140 chromemoly steel standard.

Rifling: Precision button-rifled for maximum accuracy in standard heavy match-grade barrel

Bore: NOT chrome lined, for superior accuracy and longer life (80,000 rounds plus)

Twist Rate: 1x9"

Muzzle: Grooved for optional factory Olympic Arms muzzle brake

Capacity: Shipped with Post-Ban magazine. High capacity legal pre-ban magazines

Length: 39.5"

Weight: 7.0 lbs.

The Plinker carbine is manufactured as a low cost alternative to other standard AR15 style carbines. It is manufactured using CAST upper and lower receivers, NOT forged receivers as are found on each and every other Olympic Arms rifle. Dimensionally mil-spec, the only difference between this rifle and the GI-16 are the cast -vs- forged receivers.

Olympic Arms Products: Defending the Free World



The picture at left shows a shipment of several hundred 6.5" barreled K23 9mm sub-machine guns preparing for final inspections prior to being routed overseas to one of our NATO allies.

At Olympic Arms, this is not an uncommon sight. Having been in the business for 28 years and climbing, we have shipped our fair share of weapons to military and government units all over the globe.

In use here in the states by our own military in many different configurations, as well as federal agencies such as the FBI, Secret Service, US Marshall's Service and more, Olympic Arms is relied on to defend the freedoms of of America's citizens daily.

They have the best, why shouldn't you?

CAR-97



CAR-97 A rugged and reliable carbine. Made with the “assault weapon” look, the CAR-97 is as close as you can get to a pre-ban carbine without breaking the bank, or the law! With short carbine length handguards and a 16" heavy match-grade button rifled barrel, the CAR-97 also comes standard with the Olympic Arms post-ban muzzle brake and the CAR-style non-collapsible (fixed) stock (part # T30NC). Impress your friends, and your accountant.

CAR-97A3 As with the other PCR models, the A3 option gets you greater versatility. A picatinny flat top graces the CAR-97 and it is delivered with a detachable carry handle and A2 sights. Leave the carry handle on, and use your iron sights just like you would any other AR15 style product, or take the handle off for the use of optics or electronic sights of any type.

Receivers: 7075 T6 Aluminum Forgings; CNC Machined to exacting tolerances by Olympic Arms. *Not machined by a subcontractor.*

Finish: Black Matte Hard Anodized receivers, parkerized steel parts, and black oxide stainless steel barrels (mil-spec or better)

Action: Gas operated. Semi-auto.

Caliber/Chambering: 5.56 NATO caliber. See SAAMI for full details at www.saami.org

Sights: A-2 fully adjustable rear sight, elevation adjustable post front. Flat top optional.

Barrel: 16" 4140 Chromemoly steel heavy barrel

Rifling: Precision button-rifled for maximum accuracy in standard heavy match-grade barrel

Bore: NOT chrome lined, for superior accuracy and longer life (80,000 rounds plus)

Twist Rate: 1x9"

Muzzle: Standard with factory Olympic Arms muzzle brake

Capacity: Shipped with Post-Ban magazine. High capacity legal pre-ban magazines

Length: 34.75"

Weight: 7.2 lbs.

THE CAR-97 IS ALSO AVAILABLE IN THESE PISTOL CALIBERS

CAR-97-9	9mm caliber	\$876⁰⁰
	sold with 32 round converted Sten mag.	
CAR-97-10	10mm	\$876⁰⁰
	sold with 10 round converted Uzi mag.	
CAR-97-40	40 S&W caliber	\$876⁰⁰
	sold with 10 round converted Uzi mag.	
CAR-97-45	45 ACP caliber	\$876⁰⁰
	sold with 10 round converted Uzi mag.	
Extra Mags	(32 round 9mm, 10 rnd all other calibers)	\$60⁰⁰



High capacity magazines available for the 9mm only!

CAR-97M4



**Only
\$839⁰⁰**

**CAR-97M4A3
\$934⁰⁰**
(shown at right)

A standard catalog item for the first time in 2003, Olympic Arms now offers you an upgrade option for the CAR-97 to include the military's Special Ops M4-style upgrade package. Having worked closely with the military's developmental upgrade program for the M16M4 Carbine, we know what it takes to make a good one, and this is a good one! Standard features include a 16" button rifled match grade 416 stainless steel barrel with black oxide finish and military M4 contour barrel, fixed carbine stock, factory installed muzzle brake and M4 style oversized fiberite handguards. Lightweight, rugged, and that military look make this one of the best selling carbines in our stable.

Receivers: 7075 T6 Aluminum Forgings; CNC Machined to exacting tolerances by Olympic Arms. *Not machined by a subcontractor.*

Finish: Black Matte Hard Anodized receivers, parkerized steel parts, and black oxide stainless steel barrels (mil-spec or better)

Action: Gas operated. Semi-auto.

Caliber/Chambering: 5.56 NATO caliber. See SAAMI for full details at www.saami.org

Sights: A-2 fully adjustable rear sight, elevation adjustable post front. Flat top optional.

Barrel: M4 contour 16" 416 stainless steel with black oxide finish standard.

Rifling: Precision button-rifled for maximum accuracy in standard heavy match-grade barrel

Bore: NOT chrome lined, for superior accuracy and longer life (80,000 rounds plus)

Twist Rate: 1x9"

Muzzle: Standard with factory Olympic Arms muzzle brake

Capacity: Shipped with Post-Ban magazine. High capacity legal pre-ban magazines

Length: 34.75"

Weight: 6.8 lbs.

CAR-97-M4UR

\$528⁰⁰

CAR-97-M4A3UR

\$618⁰⁰



Oly Fact!

In case you haven't noticed, the top of each page of this catalog is emblazoned with the phrase, "60 DAY SATISFACTION GUARANTEE AND LIFETIME WARRANTY". At Olympic Arms, this is more than just a slogan or motto, we live this pledge, and have done so for 26 years.

How can we do this you ask? Simple. It's easy to warranty what you manufacture. When the majority of your parts are made by someone else, and your finished product is assembled using parts that someone else made with your name on it, it becomes more difficult to warranty the product. We do not have such a problem.

When we say lifetime warranty, we mean it. Each new Oly Arms rifle is warranted for life against manufacturers defects to the original owner for the life! Five years, ten years, 30 years, whatever. Olympic will always be there for you anytime you might need us.

FAR-15



FAR-15 (Featherweight-AR) You asked for it, and you got it. The FAR-15 is the only lightweight AR carbine offered that uses all standard metal parts! No carbon-fiber, no plastic. When the blueprints call for metal, that part is metal. Weighs in at the incredibly low weight of 4.92 lbs.! **100% interchangeable with standard mil-spec quality AR parts.**

No post ban muzzle brakes are available for the FAR-15

Receivers: 7075 T6 Aluminum Forgings; CNC Machined to exacting tolerances by Olympic Arms. *Not machined by a subcontractor.*

Finish: Black Matte Hard Anodized receivers, parkerized steel parts (mil-spec or better)

Action: Gas operated. Semi-auto.

Caliber/Chambering: 5.56 NATO caliber. See SAAMI for full details at www.saami.org

Sights: A-2 fully adjustable rear sight, elevation adjustable post front. Flat top optional.

Barrel: 16" 4140 chromemoly steel with parkerized finish

Rifling: Precision button-rifled for maximum accuracy in standard heavy match-grade barrel

Bore: NOT chrome lined, for superior accuracy and longer life (80,000 rounds plus)

Twist Rate: 1x9"

Muzzle: Standard. No muzzle break available for the FAR-15 model.

Capacity: Shipped with Post-Ban magazine. High capacity legal pre-ban magazines

Length: 34.75"

Weight: 4.92 lbs.

Note:

Post ban muzzle brakes are not available for the FAR-15. Because of the small muzzle diameter, and the limited number of light-weight barrels sold in comparison to standard heavy weight barrels, muzzle brakes are not manufactured for this model. For those customers seeking a lightweight weapon capable of being outfitted with a post ban muzzle break, please consider the CAR-97M4 model on page 15.



The FAR-15UR: \$478.00

FAR-15 Lightweight upper receiver only. Shipped complete with Bolt carrier assembly and charging handle. 100% assembled and test fired. Lifetime warranty!



PCR-7 “ELIMINATOR”



PCR-7
\$844⁰⁰

PCR-7A3
\$985⁰⁰

Receivers: 7075 T6 Aluminum Forgings; CNC Machined to exacting tolerances by Olympic Arms. *Not machined by a subcontractor.*

Finish: Black Matte Hard Anodized receivers (mil-spec or better), parkerized steel parts, black oxide finish on SS barrels

Action: Gas operated. Semi-auto.

Caliber/Chambering: 5.56 NATO caliber. See SAAMI for full details at www.saami.org

Sights: A-2 fully adjustable rear sight, elevation adjustable post front. Flat top optional.

Barrel: 16" 4140 chromemoly steel with parkerized finish standard, with 20" sight radius (see below for details)

Rifling: Precision button-rifled for maximum accuracy in standard heavy match-grade barrel

Bore: NOT chrome lined, for superior accuracy and longer life (80,000 rounds plus)

Twist Rate: 1x9"

Muzzle: Standard. No muzzle break available for the FAR-15 model.

Capacity: Shipped with Post-Ban magazine. High capacity legal pre-ban magazines

Length: 34.75"

Weight: 4.92 lbs.



COMPLETE UPPER RECEIVER ASSEMBLY

ALSO AVAILABLE

PCR-7UR \$524⁰⁰

So what exactly is an “Eliminator”?

We are so glad that you asked...

When the Eliminator style of AR style rifle was introduced years ago, the idea was a good one. Produce a 16" barreled rifle, with the sight radius of the 20" version and get the benefits of both designs in a compact platform Well, the idea was

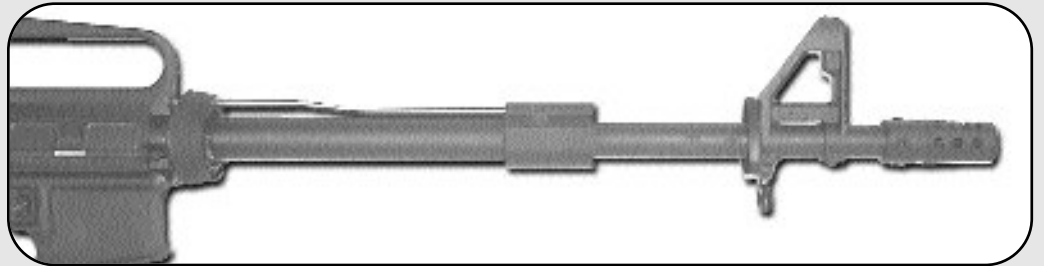

great, but the execution of the application was poor. Originally the application of this idea was performed by simply cutting down a 20" barrel. However, due to the fact that the gas port is in such a close proximity to the muzzle, the firing of the weapon did not reliably generate the amount of gas pressure required to consistently operate the AR15's system. For this reason, we began to produce the Eliminator, and do it right. Olympic Arms took the concept, and redesigned it. Rather than cut down a 20" barrel, we produced an all new 16" barrel with the 16" gas system, and contoured it to accept the standard front sight base assembly at the same location it would have been on a 20" rifle's barrel. In other words, the gas port hole is on the barrel in the same location (As seen above. Notice the gas block assembly in the center of the barrel utilizing the standard carbine gas tube.), and is the same size as if it were a true carbine with a 16" barrel. The front sight base assembly is at the 20" barrel location required for the outfitting of the standard A2 handguards, but it is not used as a part of the gas system. It simply holds the handguards and the front sight assembly. This successful design has brought the Eliminator to its rightful place among the industry leaders in quality tactical AR systems.

Olympic Arms, again leading the industry in technology and Meeting the Demands of the 21st Century!

NEW FOR 2004 NEW FOR 2004 NEW

PCR-8MAG

Winchester®
Super-Short
Magnum

To boldly go where no AR has gone before...



\$1,074.00

MSRP \$1,074.00

Out perform your friend's .308 for Hundreds of Dollars Less!!

Well accustomed to leading the AR style rifle industry in product innovation, Olympic Arms is proud to announce the production of the **PCR-8MAG**, a flat-top target-grade PCR rifle in the new **WINCHESTER® SUPER-SHORT MAGNUM** cartridges. Now you can own an AR style rifle that outperforms your friends .308 based rifle. Available in both the .223 and .243 Winchester WSSM® chamberings, the PCR-8 Magnum launches a 55 grain 223 bullet at 3,950 FPS, and a 243 55 grain at 4,000 FPS!! Not your standard AR15 style rifle, the new Magnum models are outfitted with proprietary high-pressure bolts, barrel extensions, bolt carriers and modified upper receivers, but will function on any standard .223/5.56 caliber lower without modification to the lower! Buy the whole rifle and spend hundreds less than those .308 rifles, or turn your .223 cal AR into a **MAGNUM** rifle just by switching the upper! *With ballistics far superior to standard .308 based cartridges, all other "large receiver" AR's will soon be obsolete!* Just remember as others jump on the band-wagon, Olympic Arms **BUILT** the band-wagon!

BUT WAIT! THERE'S MORE

The PCR-8 MAG will soon also be available in **308 Olympic Magnum** and **7mm Olympic Magnum**. These chamberings are offered only by Olympic Arms and are based on the 223 WSSM® casings necked to suit the .308 and 7mm bullets.



Complete Conversion Uppers:

\$672.00

Specify caliber and length.



Receivers: 7075 T6 Aluminum Forgings; CNC Machined to exacting tolerances by Olympic Arms. *Not machined by a subcontractor.*

Finish: Black Matte Hard Anodized receivers, parkerized steel parts (mil-spec or better)

Action: Gas operated. Semi-auto.

Caliber/Chambering: 223 or 243 WSSM® calibers or 300 or 7mm Olympic Magnum cartridges.

Sights: Picatinny flat top and Picatinny gas block standard

Barrel: 24" 4140 chromemoly steel bull barrel with parkerized finish standard. 20" also available

Rifling: Precision button-rifled for maximum accuracy in standard heavy match-grade barrel

Bore: NOT chrome lined, for superior accuracy and longer life (80,000 rounds plus)

Twist Rate: 1x9"

Muzzle: Standard bull barrel dimension of .928" with target crown

Capacity: Shipped with Post-Ban magazine. High capacity legal pre-ban magazines

Length: 42.5"

Weight: 9.45 lbs. (w/24" bbl)

NEW FOR 2004 NEW FOR 2004 NEW

PCR-8

Price Reduced for 2004! Only \$803.00

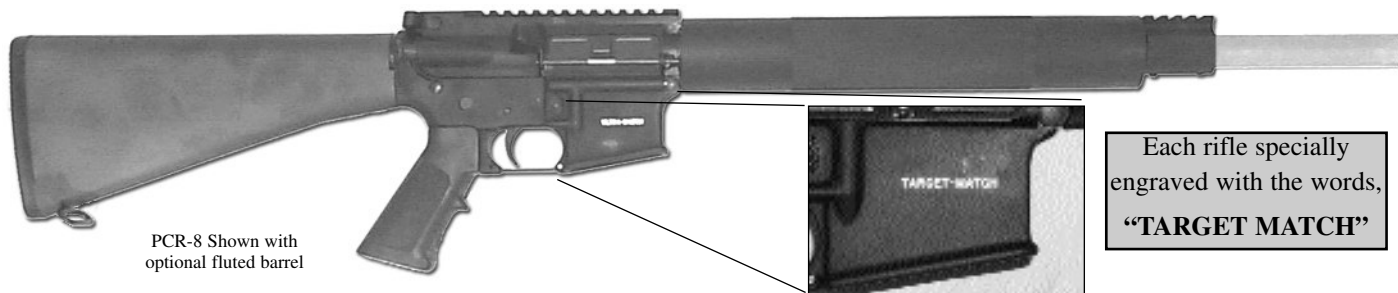

PCR-8 Shown with optional fluted barrel

Each rifle specially engraved with the words, "TARGET MATCH"

When the PCR-1 Ultramatch is just out of your price range, or simply too much gun, the PCR-8 is a great option. The PCR-8 was engineered for extreme accuracy, yet to be affordable for our budget-minded consumers. Patterned after the PCR-1 Ultramatch rifle, most shooters will be hard pressed to find a difference between the two. Performance will be similar with the main difference being the barrels. The PCR-1 is standard with our Ultramatch barrel (marked "SUM") and chambered with a match-grade .223 Remington chamber. The PCR-8 is outfitted with a stainless steel button rifled barrel chambered in 5.56x45 NATO. Expect 1/2" groups or better at 100 yards with the PCR-8 right out of the box. **We do.**

Receivers: 7075 T6 Aluminum Forgings; CNC Machined to exacting tolerances by Olympic Arms. *Not machined by a subcontractor.*

Finish: Black Matte Hard Anodized receivers (mil-spec or better), parkerized steel parts, matte SS finish on barrel

Action: Gas operated. Semi-auto.

Caliber/Chambering: 5.56 NATO caliber. See SAAMI for full details at www.saami.org

Sights: Picatinny flat top upper receiver and gas block standard

Barrel: 20" 416 stainless steel bull barrel standard

Rifling: Precision button-rifled for maximum accuracy in standard heavy match-grade barrel

Bore: NOT chrome lined, for superior accuracy and longer life (80,000 rounds plus)

Twist Rate: 1x9" Standard

Muzzle: crowned

Capacity: Shipped with Post-Ban magazine. High capacity legal pre-ban magazines

Length: 38.5"

Weight: 8.5 lbs.

PCR-8 Upper Receiver Only: \$498.00



All PCR-8UR Uppers are fully assembled, headspaced and test-fired at the factory. Standard barrels are 20" 416 SS button rifled bull barrels with a satin bead-blast finish.

"I recently purchased your 'Ultramatch' AR-15 with the 20" barrel. The guy selling me the rifle said they got 1/4" groups out of them. I was pretty skeptical, as getting quarters out of a bolt gun is tough enough. However, he was right! The first night I got a .260 with 40-grain Ballistic tips. Knowing it would probably shoot better with the heavier bullets, I tried some 55-grain Ballistic tips and shot the best group of my life, a .074". I was witnessed by Kevin Huxoll, a correctional officer at the Washington State Penitentiary. Thanks for a great gun!"

Corey Reynard

DEALERS! Don't forget that Olympic Arms products can also be ordered through any one of our participating Dealer Distributors around the country, as well as several national wholesalers such as **RSR, Federal Arms Corporation and Lew Horton**. If you already have accounts with any of these distributors, your one-stop-shopping can include Olympic Arms products as well. If you do not already deal with any of these distributors, or do not have one near you, perhaps you may wish to become a Dealer Distributor in your area. For details on becoming a Dealer Distributor, please look inside the front cover.

PCR-16



Only
\$714⁰⁰

An amazing price on an amazing little carbine!

Quickly building a reputation for excellent accuracy along with superb reliability, the PCR-16 is one of best selling AR style rifles in the industry. Standard with a 16" button rifles 41450 chromemoly steel barrel, this sweet little carbine has yet to disappoint any shooter. The free floated 16" bull barrel is producing sub moa and even sub 1/2 moa out to the limitations of it's carbine length barrel. You can stack this little carbine up against any out of the box production 20" barreled rifle out there. Compact, reliable, superbly accurate, lifetime warranty. Need we say more.

Receivers: 7075 T6 Aluminum Forgings; CNC Machined to exacting tolerances by Olympic Arms. *Not machined by a subcontractor.*

Finish: Black Matte Hard Anodized receivers, parkerized steel parts (mil-spec or better)

Action: Gas operated. Semi-auto.

Caliber/Chambering: 5.56 NATO caliber. See SAAMI for full details at www.saami.org

Sights: A-2 fully adjustable rear sight, elevation adjustable post front. Flat top optional.

Barrel: 16" 4140 chromemoly steel with parkerized finish

Rifling: Precision button-rifled for maximum accuracy in standard heavy match-grade barrel

Bore: NOT chrome lined, for superior accuracy and longer life (80,000 rounds plus)

Twist Rate: 1x9"

Muzzle: Standard. No muzzle break available for the FAR-15 model.

Capacity: Shipped with Post-Ban magazine. High capacity legal pre-ban magazines

Length: 34.75"

Weight: 4.92 lbs.

UPPER RECEIVER ONLY: \$459⁰⁰



Standard with a 16" bull barrel, picatinny gas block, aluminum free floated handguard assembly and picatinny flat top upper, the PCR-16UR is fully assembled, headspaced, test fired. It comes complete with bolt carrier assembly and charging handle as well. Expect half inch accuracy or better at 100 yards with decent ammo (see to the right). Don't forget our standard Lifetime Warranty as well!

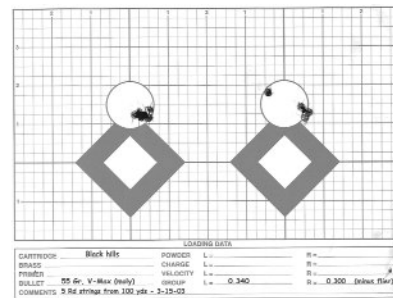

These targets were shot by an Olympic Arms customer at 100 yards using Black Hills 55 grain V-Max factory Blue box ammo. With the exception of one flyer, the Oly Arms rifle performed excellently with 2 consecutive 10

shot groups of .5"! Believe it or not, this is very common for Olympic rifles, and Oly owners all over the world have come to expect it. Accept nothing less than an Olympic Arms AR, and you will never be dissatisfied.



Be sure to check out the Official *Olympic Arms Owners Association* web site at www.aa2.org. Join the over 400 members as they discuss their Oly rifles and experiences, as well as exchange useful data and information. Ask questions, post pictures, or just make friends with other Olympic Arms owners all over the world. With members in the USA as well as places like Italy, and Belgium, you'll soon see that Olympic Arms and their products are respected world wide! Membership is FREE, so join today and begin expanding your Oly Arms experience.

PCR-9/10/40/45 PISTOL CALIBER CARBINES



\$834⁰⁰

PCR-9 These handy little pistol caliber carbines are the original and best AR15 style pistol caliber carbines anywhere. Made with a straight blow-back operations system for unparalleled reliability. Feeding is another area that will cause you no concern. With a patented conical shaped bolt and chambering system, the entire barrel extension becomes a giant feed ramp. Hollow points, no problem!

Fun and inexpensive to shoot. Also makes a great CQB carbine. Now with improved ESpring ejector spring assembly.

CHOOSE FROM THESE PISTOL CALIBERS

PCR-9	9mm caliber	\$834⁰⁰
	sold with 32 round converted Sten mag.	
PCR-10	10mm	\$834⁰⁰
	sold with 10 round converted Uzi mag.	
PCR-40	40 S&W caliber	\$834⁰⁰
	sold with 10 round converted Uzi mag.	
PCR-45	45 ACP caliber	\$834⁰⁰
	sold with 10 round converted Uzi mag.	

Pistol caliber magazines

Extra magazines are available for all pistol caliber uppers. The 9mm magazines are pre-ban 32 round converted Sten mags. The magazines for the 45ACP, 10mm, and 40S&W are post-ban 10 round converted Uzi magazines. No high capacity magazines remain available for those calibers.

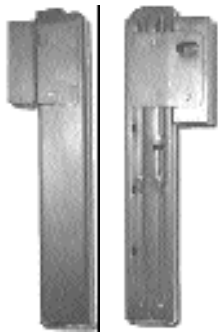

K9M	\$65⁰⁰	32 round
K10M	\$65⁰⁰	10 round
K45M	\$65⁰⁰	10 round
K40M	\$65⁰⁰	10 round

No mag well insert blocks are needed. Our magazines come with a mag well block adapter attached to the mag body itself. No fumbling with alternative mag releases or separate blocks to bend, break or lose.



Also available in:
Flat-top.....N/C
A3 w/ detachable carry handle:
Add.....**\$95.00**

Pistol Caliber Upper Conversions: \$594.00



Oly Fact!

Olympic Arms was the first manufacturer of AR15 products to offer a center-fire pistol caliber model, or a pistol caliber conversion on the civilian market. As a matter of fact, Olympic was even approached by "other major military suppliers of M16's" to make these conversions for their company. We declined.

The Olympic Arms pistol caliber carbines and upper receiver conversion units were amazingly popular the first day they hit the market, and still are today. Their versatility and inexpensive operation make them a crowd favorite.

Manufactured in such a manner as to allow the switching of calibers (back and forth) from pistol caliber to 5.56 NATO in seconds, the Oly conversions are the **ONLY** conversions on the market that *do not require modifications to the lower*, or the need for additional magazine well block adapters that are easily be lost or broken, effectively making the unit unserviceable.

When shopping for pistol caliber AR15 style products, why look around; Just buy the original. Buy the best. Olympic Arms, Meeting the Demands of the 21st Century!

60 DAY SATISFACTION GUARANTEE AND LIFETIME WARRANTY

NEW FOR 2004 NEW FOR 2004 NEW

PCR-30

A 30 Carbine Caliber AR-15



\$899.00

Uses any standard unmodified 30 carbine magazines!
No modifications to the lower!

The PCR-30 AR15 style carbine is one of the latest caliber conversion units from Olympic Arms. With no modification to your standard mil-spec .223/5.56 lower, and the use of a modified magazine catch (that can be used with standard GI .223/5.56 magazines as well) *you can use unmodified standard GI M1 30 Carbine mags* and convert your AR to 30 Carbine caliber. The 30 carbine is just a fun little centerfire cartridge that is also very inexpensive to shoot. For some areas, caliber restrictions prevent the use of a 223 for hunting, and this caliber conversion will make the difference so that you can legally carry your little AR carbine in the woods for hunting. The photo to the right shows how the magazine system works in your lower. The block is inserted from the top. All PCR-30's are shipped with the magazine insert installed.

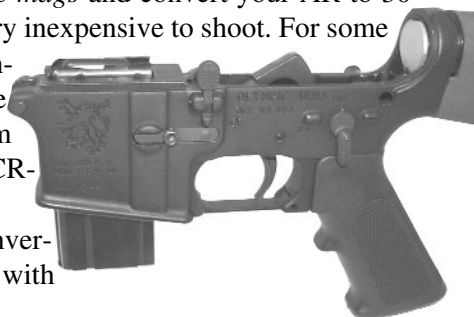

Inset shows the mag block insert and modified mag catch for the use of unmodified 30 Carbine mags.

Complete carbines (the PCR-30) and complete upper conversion units are available. Upper conversion units are shipped with magazine block, and converted magazine catch assembly.



**COMPLETE UPPER RECEIVER
CONVERSION ONLY:
PCR-30UR \$654⁰⁰**

Receivers: 7075 T6 Aluminum Forgings; CNC Machined to exacting tolerances by Olympic Arms. *Not machined by a subcontractor.*

Finish: Black Matte Hard Anodized receivers, parkerized steel parts (mil-spec or better)

Action: Gas operated. Semi-auto.

Caliber/Chambering: 30 M1 Carbine caliber. See SAAMI for full details at www.saami.org

Sights: A-2 fully adjustable rear sight, elevation adjustable post front. Flat top optional.

Barrel: 16" 4140 chromemoly steel with parkerized finish

Rifling: Precision button-rifled for maximum accuracy in standard heavy match-grade barrel

Bore: NOT chrome lined, for superior accuracy and longer life (80,000 rounds plus)

Twist Rate: 1x12"

Muzzle: Grooved for installation of optional factory Olympic Arms muzzle brake

Capacity: Shipped with one magazine. High capacity legal pre-ban magazines

Length: 39.5"

Weight: 7.15 lbs.

NEW FOR 2004 NEW FOR 2004 NEW

ALL PRICES AND SPECIFICATIONS SUBJECT TO CHANGE WITHOUT NOTICE • CALL 1-800-228-3471 • www.olyarms.com

2004 STANDARDIZED RIFLE OPTIONS LIST

Olympic Arms offers more options and variations than any other AR-15 style rifle manufacturer, period. To simplify ordering and pricing, we offer the following consolidated list of available options. Please note that not all options are available for each standard model offered. In other words, not all options are available on every model AR style rifle or carbine offer. As an example: fluting cannot be had on an M4 or pistol caliber barrel. For this reason please call one of our sales staff to ensure that the options desired are available for the particular model you are purchasing. Although the list is long, we hope that supplying the options in a consolidated list form like this will increase option awareness, and help eliminate pricing costly pricing errors, and increase your profits.

<u>COMPLETE WEAPON OPTIONS:</u>	<u>PRICE:</u>	<u>CODE:</u>	<u>NOTES:</u>
Stainless /Steel barrel upgrade	\$42.00.....	SS	SS is standard on some models
Bull Barrel Upgrade (PCR-3 only)	N/C.....	BULL	standard on PCR-1 & PCR-8 series
Factory Trigger Job	\$42.00.....	FTJ	Standard on PCR-1 thru 3
Williams Set Trigger	\$174.00.....	WST	Standard on PCR-1 thru 3 & PCR-SM
Harris Bi-Pod (standard, on rifles with free floated handguards)	\$78.00.....	HBP-1	
Harris Bi-Pods (standard, on GI handguards)	\$96.00.....	HBP-1-GI	Includes Harris #15 adapter
Harris S-Series Bi-Pods (on free float handguards)	\$86.00.....	HBP-2	
Harris S-Series Bi-Pods (on GI handguards)	\$104.00.....	HBP-2-GI	Includes #15 adapter
Bi-pod stud/mount (free float handguard)	\$24.00.....	BPS	
Bi-pod stud/mount (Harris #5 universal for GI handguards)	\$18.00.....	HBM-15	
Picatinny gas block (w/free floated handguard)	\$42.00.....	GB	not available for the FAR barrels
Picatinny gas block (w/standard GI handguards)	\$54.00.....	GB-GI	not available for the FAR barrels
Flat-top upper receiver; Picatinny style	N/C.....	FT	
A3 Picatinny flat-top upper w/Detachable Carry handle	\$90.00.....	A3	
Muzzle Brake	\$30.00.....	MB	not available for bull barrels or FAR-15.
24" barrel	\$43.00.....	+24	not available for all models
26" barrel	\$58.00.....	+26	not available for all models
Fluted barrel	\$150.00.....	F	includes custom shop fee
Ultramatch barrel upgrade	\$107.00.....	SUM	standard on some, N/A on other models
Aluminum Free-float handguard (carbine)	\$42.00.....	F8A	standard aluminum FF-handguard
Aluminum Free-float handguard (rifle)	\$52.00.....	F7A	standard aluminum FF-handguard
M4 Style handguards	\$18.00.....	M4S	for carbines only; w/single heat shield
FIRSH Rail handguard (free-floating; carbine length)	\$78.00.....	F8R	for 16" barrels
FIRSH Rail handguard (free-floating; rifle length)	\$102.00.....	F7R	for 20" barrels
FIRSH Rail handguard (free-floating; stubby length)	\$54.00.....	F23R	for 6.5" barrels
FIRSH Rail handguard (free-floating; mid-length)	\$90.00.....	F85R	for mid-length barrels
Factory Trigger Job	\$42.00.....	TJ	standard some models
2-Stage Trigger	\$107.00.....	2ST	standard on PCR-SMP model
MaxHard upper	\$60.00.....	MXU	A2 or Flat-top (Plinker excluded)
MaxHard lower	\$60.00.....	MXL	for forged receiver weapons only
Fixed collapsible stock (post-ban legal)	N/C.....	T30NC	not available for 20"+ barreled rifles
Fixed collapsible aluminum M4 stock (post ban legal)	\$42.00		
Alternative Calibers	\$54.00.....	AltCal	please ask sales rep for details
Alternate twist rates (depends on model and caliber)	\$52.00.....	Alt.	please ask sales rep for details
Ergo Grip	\$18.00.....	Ergo	specify left, right, or ambi
Ergo Sure Grip	\$24.00.....	ErgoSG	right hand only
Ergo Tactical Pistol Grip	\$50.00.....	TG	Ambidextrous with palm shelf
Ace® FX Stock	\$60.00.....	FX	standard Ace® FX stock
Ace® FX Stubby stock	\$74.00.....	FX-Stubby	stubby/entry length Ace® FX stock
Ace® Ultralight stock	\$67.00.....	FXUL	Ace® Ultralight stock
Ace® Ultralight Stubby stock	\$70.00.....	FXUL-Stubby	Ace® Ultralight Stubby length stock

Additional options may be available as we are taking on new product lines all throughout the year.

Make sure you ask your sale representative for details or updates on current option availability.

OA-98

OA-98 is the latest in the family of the OA-93 pistol systems developed by Olympic Arms, and the only real choice for those people who want a reliable post ban AR15 style pistol. Chambered in the 5.56 NATO round, this little unit packs firepower like nothing else in its class. Weighing in at a mere 49 ounces to comply with weight restrictions set by the 1994 crime bill, it's light as a feather, and as powerful as a bull ox!

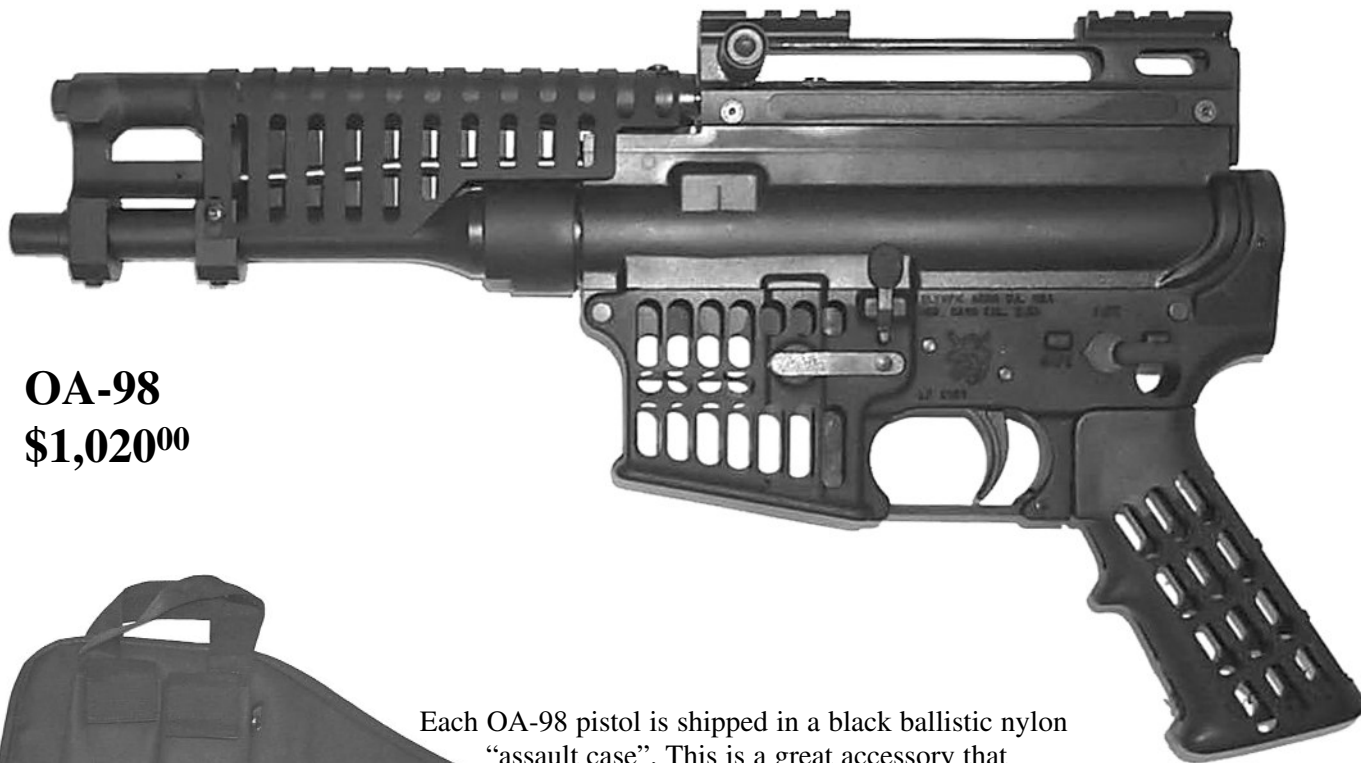

OA-98
\$1,020⁰⁰



Each OA-98 pistol is shipped in a black ballistic nylon "assault case". This is a great accessory that enhances the package for the collector or shooter. Holds 2 30 round magazines in external pouches with velcro flaps. Case secures with heavy duty zipper.

Receivers: 7075 T6 Aluminum Forgings; CNC Machined to exacting tolerances by Olympic Arms. *Not machined by a subcontractor.*

Finish: Black Matte Hard Anodized receivers (mil-spec or better), parkerized steel parts

Action: Gas operated. Semi-auto.

Caliber/Chambering: 5.56 NATO caliber. See SAAMI for full details at www.saami.org

Sights: Picatinny style flat top upper receiver ready for mounting of your favorite optics such as a Bushnell® Holosite.

Barrel: 6.5" 416 stainless steel bull barrel standard

Rifling: Precision button-rifled for maximum accuracy in standard heavy match-grade barrel

Bore: NOT chrome lined, for superior accuracy and longer life (80,000 rounds plus)

Twist Rate: 1x7" Standard

Muzzle: crowned

Capacity: Shipped with Post-Ban magazine. High capacity legal pre-ban magazines

Length: 38.5"

Weight: 49 ounces

OLYMPIC ARMS AIRSOFT CAR-97M4

Model AS01:

Comes standard with M4 stock.

All metal high-quality Airsoft training rifles from Team SD and ICS manufacturing. Exclusively available through Olympic Arms and Team SD! These are not your average Airsoft rifles!

Batteries and chargers sold separately (see bottom of page).



Only \$349⁰⁰

*No FFL required.
Must be 18 to order.*

Used by gamers, and purchased by collectors for years, Airsoft products have taken the firearms industry by storm, and sales for airsoft products have tripled in the last 3 years alone! Olympic Arms has partnered with Team SD, and is now offering a CAR-97M4 model in an Airsoft style carbine. They are available with either an M4 collapsible stock (AS02 model), or with a standard A2 fixed stock (AS01 model).



OLYMPIC ARMS CAR-97M4 FEATURES:

- ALL METAL CONSTRUCTION! All parts that are supposed to be metal, are metal!
- Two piece gear box construction
- Removable gear box, just like a real M4 bolt carrier assembly
- Select fire-fully automatic electronic firing capabilities
- 5-position collapsible stock
- Picatinny flat top with detachable carry handle
- Licensed Olympic Arms logo!
- 400+ round capacity magazines!

These carbines with their 6mm pellets are designed with a **Hop-Up** kit standard, allowing for greater velocities and more accurate firing. Designed specifically with Law Enforcement and security training in mind, these are not toys, these rifles are serious training rifles. Less expensive than a Simunitions® type rifle, the CAR-97M4 Airsoft carbine is excellent for all types of training including live fire CQB.

Starter kits: Includes the Airsoft carbine, appropriate battery and battery charger, and a 1,000 round bottle of BB's. Everything you need to get started.

AS01-P1 \$389.95

AS02-P1 \$387.95

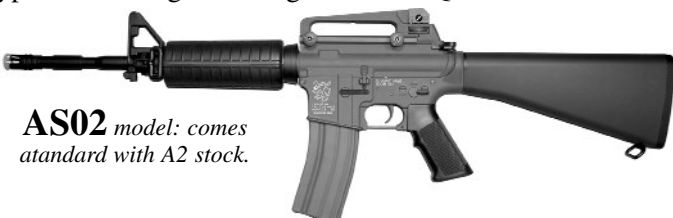

AS02 model: comes standard with A2 stock.

All Olympic Arms SD Airsoft M4 carbines will be shipped in an attractive corrugated box with color label. The Olympic M4 Airsoft carbine displayed in this box makes a attention grabbing display!



Battery Packs:

BAT2 8.4 volt for A2 stock model: **\$53⁹⁵**

BAT6 9.6 volt for M4 stock model: **\$40⁷⁵**

Battery Chargers:

ECL Charger unit for BAT2: **\$7⁹⁹**

ECS Charger unit for BAT6: **\$7⁹⁹**

ECF Fast Charger. Will work with both BAT2, and BAT6: **\$54⁹⁵**

OA-93 PRODUCTS

OA-93 AR PISTOL UPPER CONVERSION UNIT

This is the heart of the OA system. Used by Military and Government agencies around the world (including the US, and Israel) this upper is what allows the creation of the only true AR style pistol. This unit is 100% complete, and includes a complete bolt carrier assembly, aluminum barrel shroud, a 6.5" barrel assembly, and comes standard with a Vortex® or Phantom flash suppressor. *Compare at \$1,000 less than some of our competitors!*
Available in 5.56 NATO chambering only.

OA-93 AR PISTOL UPPER

6 1/2" BARREL ONLY

OA93UR \$594⁰⁰

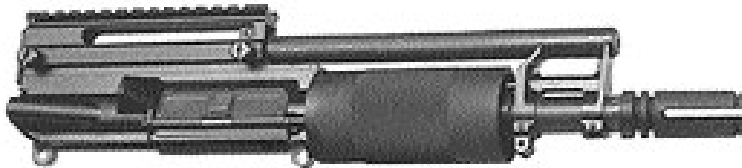

Receiver Adapter Kit

Comes with receiver end plug, and hex-head screw to cap off the takedown pin detent hole. Required to convert early pistol lowers for use with OA-93 system.

RAK. \$42⁰⁰

Note: The OA-93UR is only available for use on legally registered AR-15 pistol lower receivers that were assembled into pistol form prior to September 13, 1994 - or- any ATF registered short barreled rifle or machine gun (Form 4 required for use on NFA weapons).

THE OA-93PT CONVERSION KIT: Take any standard post ban AR15 style rifle, attach this upper and stock and you'll have an identical copy of an OA-93PT. Can't afford another rifle? Just buy this conversion kit and you're on your way!

The OA-93PT Conversion Kit comes standard with the complete upper receiver, vertical pistol grip, detachable stock, and detachable stock locking assembly. Detachable stock adapters must be assembled onto your lower to use the detachable stock.



**OA-93PT-CK
\$899.00**

THE OA-93 CARBINE CONVERSION KIT

This conversion unit can be utilized to turn any pre-ban AR-15 into an OA-93 carbine. Simply remove your standard upper, replace it with the OA-93C upper, change out the stock, and there you have it. This unit has a 16" barrel assembly and side folding stock, and comes fully assembled and test fired with all the parts needed to drop on your lower and start shooting. It also comes standard with a Vortex® flash hider. Pre-ban configuration and 5.56 NATO caliber only.



Note: Side folding stock cannot be used on any AR-15 without the OA-93 style upper, and is not available as a separate component.

OA-93CKIT

Complete OA-93 Carbine kit Including the side folding stock.

\$779⁰⁰

OA-93CUR

Upper receiver only

\$659⁰⁰

Note: The OA-93 carbine conversion kit can only be used on legally "grandfathered" pre-ban semiautomatic assault weapons as defined by the 1994 Crime Bill.

UPPER RECEIVER UNITS

Upper receiver units are available either 100% complete (option "C"), or stripped (option "S"). Fully assembled these uppers are headspaced and test fired at the factory. Stripped, these uppers do not include the bolt carrier assembly or charging handle, and are therefore NOT headspaced or test fired. When utilizing stripped uppers, the purchaser assumes all responsibility with regards to proper headspace and function. Either way, they come with the standard 60-day satisfaction guarantee, and a lifetime warranty. See available options per unit. *All units will be shipped as post ban complete assembled units and billed accordingly unless otherwise specified at the time of the order.*



K1. Carbine Top Half Assembly 16" Upper Receiver Unit

Comes standard with HMG contour button rifled match grade 4140 chromemoly steel barrel.

K1SA \$353⁰⁰
K1CA \$436⁰⁰

NOTE: K1SA is *stripped*, and does not come with a bolt carrier assembly or charging handle.



NOTE: K2SA is *stripped*, and does not come with a bolt carrier assembly or charging handle.

K2SA \$384⁰⁰
K2CA \$473⁰⁰

K2. Rifle Upper Receiver 20" Heavy Barrel standard match upper Assembly includes

Standard with HMG contour button rifled match-grade 4140 chromemoly steel barrel.

K1 Options:

U	Unassembled	-\$35⁰⁰
SS	Stainless Steel barrel	\$42⁰⁰
CAR	Car barrel 11.5" barrel w/ 5.5" permanently attached flash suppressor.	\$24⁰⁰
Pre	Pre-ban threaded 16" barrel w/bayonet lug	N/C
M4	16" M4 contour barrel	\$42⁰⁰
M4S	M4 style handguards	\$20⁰⁰
FT	Flat top receiver	N/C
A3	Flat-top upper w/detachable Carry handle	\$95⁰⁰
ALT	Alternate twist rate barrel	\$52⁰⁰
Elim	Eliminator (PCR-7) barrel	\$52⁰⁰
F	Fluted barrel	\$149⁰⁰
F8R	Carbine length FIRSH rail handguard	\$78⁰⁰
FAR	Featherweight barrel option	\$42⁰⁰

K2 Options:

U	Unassembled	-\$35⁰⁰
SS	Stainless Steel barrel	\$42⁰⁰
Pre	Pre-ban threaded 20" barrel w/bayonet lug.	N/C
FT	Flat top receiver	N/C
A3	Flat-top upper w/detachable Carry handle	\$95⁰⁰
ALT	Alternate twist rate barrel	\$52⁰⁰
24	24" barrel	\$43⁰⁰
F	Fluted barrel	\$149⁰⁰
F7R	Full length FIRSH Rail handguard	\$102⁰⁰

K6. (the top half of a PCR-1) Is the most accurate upper receiver available anywhere. Guaranteed to shoot 1 moa or better, we actually expect 1/2" or smaller groups right out of the box with quality factory ammo. Comes standard with a 416 stainless steel broach cut Ultramatch® (SUM) barrel in a 20" length and a 1x10 twist.



K6. PCR-1/Ultramatch® Upper Receiver **K6 \$636⁰⁰** Assembly includes

- 20" Ultramatch Bull barrel
- Aluminum handguard
- Picatinny Flat-top upper receiver unit
- Crowned barrel
- Picatinny gas block

K6 Options:

W/O:	Without Bolt carrier assembly	-\$73⁰⁰
1x8	1x8" twist rate barrel	N/C
24	24" barrel	\$43⁰⁰
26	26" barrel	\$58⁰⁰
ST	Bi-pod stud installed	\$24⁰⁰
B	Harris bi-pod installed.	\$78⁰⁰
B2	Harris S-series bi-pod installed	\$86⁰⁰
F	Fluted barrel	\$149⁰⁰
F7R	FIRSH Rail Handguard	\$102⁰⁰



K8. The K8 is the upper receiver unit from the PCR-8. This unit is identical in configuration to the K6 upper, but utilizes a button rifled match-grade barrel with a satin bead blasted stainless steel finish. This upper, standard with the bull barrel is capable of sub moa groups all day long. A great inexpensive option that will give excellent accuracy, and a great looking rifle. Same options available as the K6 upper seen above.

K8 \$498.00

All upper conversion units are available in either Pre-Ban or Post-Ban configuration. Prices are the same either way. Please specify.

UPPER CONVERSION UNITS



Convert your existing .223/5.56 caliber AR15 style rifle into one of 4 different pistol calibers. It's as easy as pushing two pins, and can be done in less than 30 seconds! The original, and still the best!

PISTOL CALIBER CONVERSION UNITS

(AND HOW THEY WORK)

The pistol cartridge conversion units in calibers 9mm, .40 S&W, .45 ACP and 10mm are blowback-operated. The bolt and barrel extension utilize a patented forcing cone system that is designed to handle all loads – ball, semi-wadcutter, hollowpoint, and all other ammunition. All four calibers have a non-rotating bolt with no lugs. The firing pins are identical to a .223 except that they are spring-loaded to prevent inertia firing. Cyclic rates/speeds are regulated in the blowback system by use of a proprietary and patented weighted bolt carrier assembly suitable to the caliber being used.

We have engineered these units to enable the user to change calibers in less than one minute by simply pushing through the front and rear takedown pins, and replacing the whole upper unit. Once this is done, insert the proper magazine, and you are ready for the range.

Accuracy is exceptional (average 1.0" – 1.50" at 50 yards) due to the use of Olympic's own match grade button rifled barrels.

BOTTOM LINE

No other rifle in the world offers the versatility of the AR15 style rifle. No other company offers you the same versatility of Olympic Arms. Whether a weekend plinker, or a law enforcement officer, these weapons systems are your best options. Multiple calibers, one lower. Your options are almost endless.

A1 UPPER SHOWN IS NO LONGER AVAILABLE. FLAT TOP OR A2 ONLY.



MODIFIED UZI MAGAZINE WITH BUILT-IN MAGAZINE WELL BLOCK



MODIFIED STEN MAGAZINE WITH BUILT-IN MAGAZINE WELL BLOCK



BOLT (OBLIQUE VIEW)



BOLT & BOLT CARRIER

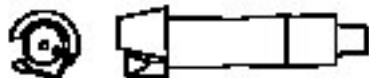
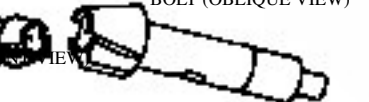

BOLT (SIDE VIEW)

Pistol caliber magazines

Extra magazines are available for all pistol caliber uppers. The 9mm magazines are pre-ban 32 round converted Sten mags. The magazines for the 45ACP, 10mm, and 40S&W are post-ban 10 round converted Uzi magazines. No high capacity magazines remain available for those calibers.

- K9M** \$50⁰⁰ High capacity 32 round magazine.
- K10M** \$50⁰⁰ 10 round magazine
- K45M** \$50⁰⁰ 10 round magazine
- K40M** \$50⁰⁰ 10 round magazine

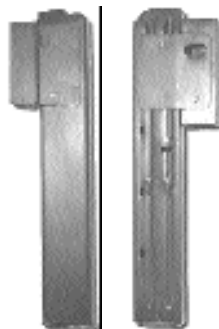

No mag well insert blocks needed. Our magazines come with a mag well block adapter attached to the mag body itself. No fumbling with alternative mag releases or separate blocks to bend, break or lose.

PISTOL CALIBER UPPER CONVERSION UNITS

The original pistol caliber upper conversions! These conversion upper receiver units will allow you to fire pistol caliber cartridges from your standard mil-spec AR-15 lower. With the patented forcing cone chambers and the unique spring ejector system, these uppers are extremely reliable and accurate. Now standard with stainless steel button rifled barrels. *Available in 16" barrels only. Blow back operation. Not standard with muzzle brake.*



PCR-9UR	9mm upper conversion unit	\$594⁰⁰
PCR-10UR	10mm upper conversion unit	\$594⁰⁰
PCR-40UR	40 S&W upper conversion unit	\$594⁰⁰
PCR-45UR	45 ACP upper conversion unit	\$594⁰⁰

Uppers are available in pre or post-ban configuration.

Options:

FT	Flat top upper receiver	N/C
A3	Flat top upper receiver with detachable carry handle.	\$90⁰⁰
MB	Post-ban Muzzle Brake	\$30⁰⁰
PRE	16" Pre-ban barrel w/threaded Muzzle and flash suppressor	N/C
CAR	Pre-ban CAR barrel with 11.5" barrel and 5.5" permanently attached Flash suppressor.	\$24⁰⁰
F8R	FIRSH Rail Handguard	\$78⁰⁰
SB	Short Barrel	\$42⁰⁰
FA	Full Auto configured	\$42⁰⁰

Class III Pistol Caliber Conversion Options

Muzzle Threads

All pistol caliber 16" pre-ban uppers are threaded with a 5/8 x 24 TPI thread pitch. Alternate thread pitches are available upon request.

Standard military 1/2" x 28 TPI thread pitch is available on 9mm caliber uppers only.

Custom Thread Pitches: \$35⁰⁰

All pistol caliber conversion upper receiver units are available in Class III configurations. A copy of your weapons Form 4, or your company's valid SOT is required for all Class III transactions.

Use these option codes when ordering:

FA	Full auto. Includes FA carrier, weighted buffer, and choice of 16" or 11" bbl.	\$42⁰⁰
SB11	Short barrel, 11" in length. (semi-auto)	\$42⁰⁰
SB6.5	Short barrel, 6.5" in length. Comes with aluminum free-float handguard	Add an additional \$42⁰⁰

Alternate Rifle Caliber Uppers

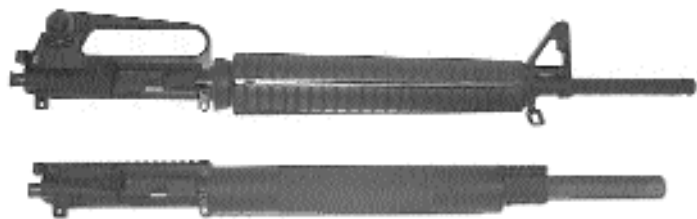

**17 Remington
6 x 45
300 Fireball**

**222 Remington
6mm PPC
7.62 x 39mm**

(add \$52.00 to the cost of a similarly configured 223/5.56 upper)

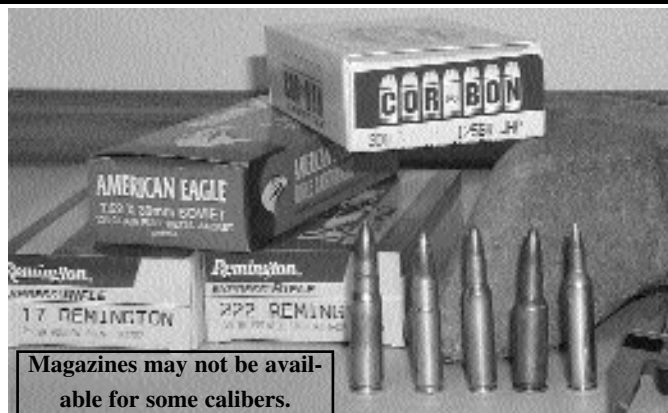

Magazines may not be available for some calibers.

Offering more caliber options than any other manufacturer anywhere, we are still making uppers in alternative calibers, and it seems the list takes on more calibers each year. The latest addition is the popular **300 Fireball**. A true 30 caliber round based on a 221 Fireball case, this is perfect for subsonic use, or varminting. Calibers are restricted to those listed above. Configuration availability and pricing varies, please check with our sales staff for details. *Please be prepared for a minimum delivery time of 90 days, and up to 6 months.*

AR/PCR Pistol Caliber Conversion Parts

NOTE: The pistol caliber parts, components and assemblies found on this page are proprietary to Olympic Arms pistol caliber AR15 products only and are NOT interchangeable with other manufacturer's 9mm components.

Pistol Caliber Bolt Carrier Assembly.

Complete bolt carrier assembly for our popular pistol caliber AR15's. Available in 9mm, 10mm, 40 S&W and 45 ACP. *Specify Caliber when ordering.*

PC24 **\$132⁰⁰**

PC24FA **\$132⁰⁰** (Full-auto. Requires form 4)



PC24



PC26

Pistol Caliber Bolt Assembly

This is the patented conical bolt assembly used in Olympic pistol caliber conversions. It comes 100% complete with Extractor. *Specify caliber when ordering.*

PC26 **\$78⁰⁰**

ESPRING® Pistol Caliber Ejector Spring



A highly sought after replacement part for the pistol caliber upper receiver conversion units produced by Olympic Arms. The new **ESEJP** ejector springs will last longer than ever. Made from a specifically engineered alloy to work under these conditions, the ESEJP will not weaken or bend with age. Whether enjoying the 9mm, 10mm, 40 S&W or 45 ACP models, this spring works for all of them. A great spare part to have in your tool kit, the ejector spring is a proprietary part that your pistol caliber upper requires.

ESEJP **\$5⁰⁰ each**

Inexpensive, and easy to install.



PC28. Pistol Caliber Ejector Spring Assembly

This complete assembly comes with 1 ea. ejector spring, ejector spring retainer, ejector spring retainer pin,

and ejector spring positioning spring. A complete replacement set or spare assembly. **PC28** **\$12⁰⁰**

PC39B. Pistol Caliber Firing Pin Spring



This is a required item for all of our pistol caliber upper conversions. Because of the blow-back operation system of the pistol caliber uppers, this firing pin spring is required to prevent inertia firing from occurring.

PC39B **\$1⁵⁰ea.**

PC38. Pistol Caliber Extractor Spring.

Extractor spring for pistol caliber bolt assemblies. Always good to have a spare or two around. This is not the same extractor spring as for the .223/5.56 caliber bolt.



PC38 **\$1⁵⁰ea.**

PC36. Pistol Caliber Extractor



Machined extractor for pistol caliber conversions. Specify 9mm, 10mm, 40 S&W or 45 ACP when ordering. Does not include extractor spring sold separately.

PC36 **\$22⁰⁰**

NOTE: The pistol caliber parts, components and assemblies found on this page are proprietary to Olympic Arms pistol caliber AR15 products only and are NOT interchangeable with other manufacturer's 9mm components.

AR-15 RECEIVERS

With 27 years in the business, and a history of having made receivers and receiver units for *many other name-brand manufacturers*, no other company can offer you the quality and variety in receivers that Olympic Arms does. From standard 7076 T6 aluminum forgings to cast receivers for those on a budget, to the world's only all Titanium lowers, we have got you covered. See below for all the options.



- T2** Forged A2 upper (stripped) **\$92⁰⁰**
- T2MX** Maxhard® Forged A2 upper (stripped) **\$167⁰⁰**



- T12** Forged Picatinny Flat-top upper (stripped) **\$107⁰⁰**
- T12MX** Maxhard® Forged Picatinny Flat Top upper (stripped) **\$167⁰⁰**



K5A



Post-Ban fixed CAR stock. *Does not collapse.*

K5A97

- K5A** Fully assembled Lower receiver assembly unit (with T3 lower). **\$269⁰⁰**
- K5U** Unassembled K5A **\$239⁰⁰**
- K5A97** Fully Assembled Lower receiver assembly unit (with CAR-97 Stock) **\$268⁰⁰**
- K5U97** Unassembled K5A97 **\$239⁰⁰**
- K5CA** Fully assembled cast lower unit **\$228⁰⁰**
- K5CU** Unassembled K5CA **\$210⁰⁰**

Mil-spec forged receiver, CNC machined by Olympic Arms in house from 7076 T6 Aluminum forgings. Our most popular receiver.

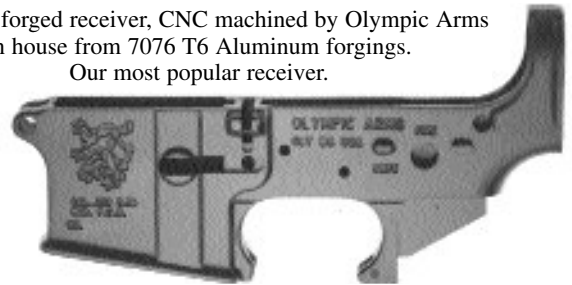

T3

- T3** Forged A2 lower receiver (stripped) **\$129⁰⁰**

Olympic Arms exclusive MaxHard® receiver. A proprietary chemical heat-bath process hardens this forged mil-spec lower to *Rc 20+*! Excellent for National Match, Hi-Power and CMP rifles. MaxHard; Only from Olympic Arms.

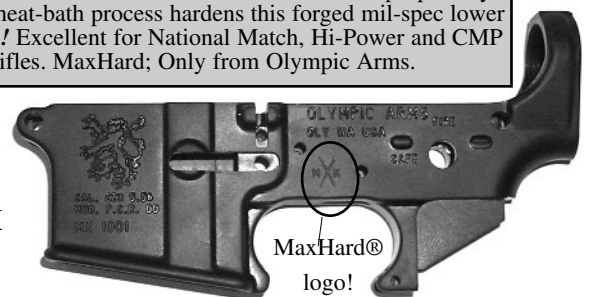

T3MX

MaxHard® logo!

- T3MX** Maxhard® Forged lower (stripped) **\$167⁰⁰**

This cast receiver is the same receiver we use on our popular Plinker® carbine. Made from A356 Aluminum it is strong enough to last a lifetime.

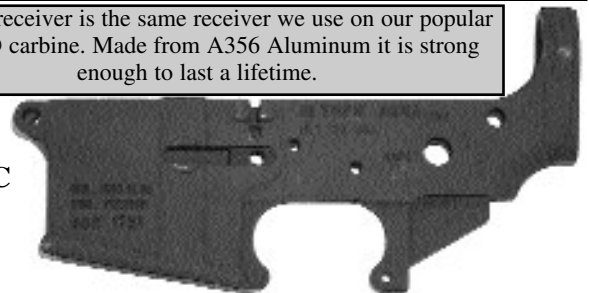

T3C

- T3C** CAST A2 lower receiver (stripped) **\$82⁰⁰**

The worlds only Titanium AR lower receiver! Weighs half as much as steel, but 10 times stronger!

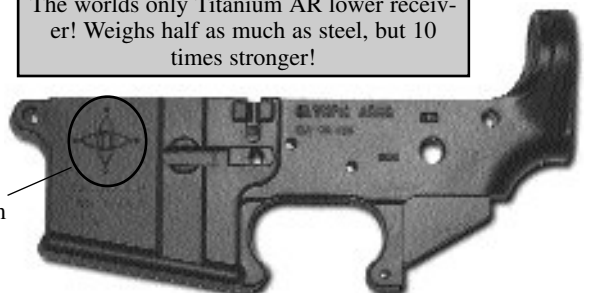

T3Ti

Titanium Logo

- | T3Ti | Titanium Lower Receiver | Market Price |
|-------------|--|---------------------------|
| T5 | Matched Set T2 upper and T3 Lower. | \$198⁰⁰ |
| T5MX | Matched Set of T2MX, and T3MX . | \$312⁰⁰ |
| T6 | Matched Set of T3 lower and T12 upper receivers. | \$212⁰⁰ |
| T6MX | Matched Set of T3MX lower and T12MX upper receivers. | \$312⁰⁰ |

AR-15/PCR PARTS

T11. UPPER RECEIVER UNIT T – E-2

Includes: Upper receiver – E-2, E-2 rear sight assembly, ejection cover assembly, forward assist assembly.

\$166⁰⁰

Assembled – add \$24.00

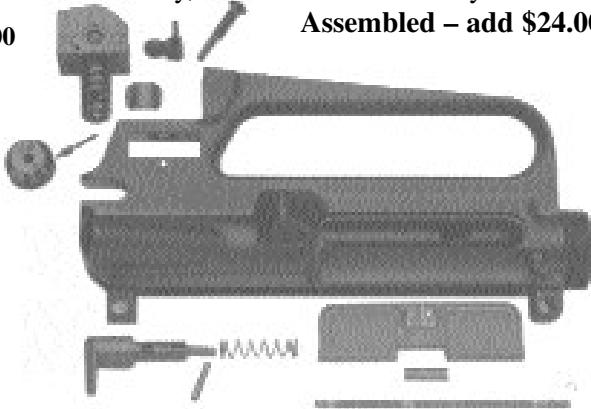

T12A. UPPER RECEIVER with forward assist and ejection cover assembly

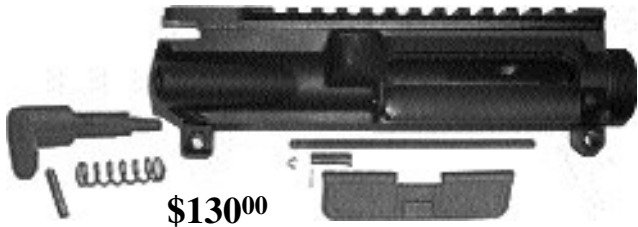

\$130⁰⁰

F11. DETACHABLE A2 CARRY HANDLE Complete with sight assembly.



\$95⁰⁰

T13. SCOPE MOUNT BASE FOR A2 UPPERS. This is a SEE THROUGH mount. Inexpensive, and very functional.



\$11⁰⁰



2ST. TWO STAGE TRIGGER.

A fine two stage trigger machined from quality carbon steel. Drops in for use in any standard mil-spec lower.

Stand Alone: \$118⁰⁰

Upgrade on Rifle: \$107⁰⁰

T23. CHARGING HANDLE

Machined from 7075 T6 aluminum forging according to military specifications. 100% complete.

\$24⁰⁰

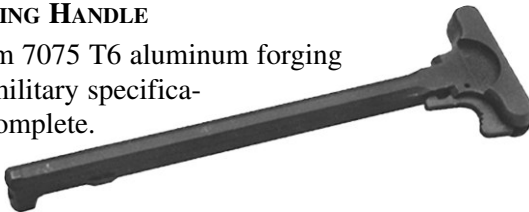

T21. ROUND FORWARD ASSIST ASSEMBLY 100% Complete.



\$16⁰⁰

T14. E-1 REAR SIGHT ASSEMBLY

Includes new rear sight aperture, adjustable screw, detent and spring, leaf spring, windage drum and roll pin.

\$25⁰⁰



T15. E-2 REAR SIGHT SYSTEM

Includes all parts to complete system

\$60⁰⁰



T15A. NATIONAL MATCH E-2 REAR SIGHT SYSTEM

Includes all parts to complete system

\$90⁰⁰

BJS. NATIONAL MATCH INTERCHANGEABLE APERTURE SIGHTS:

\$59⁹⁵

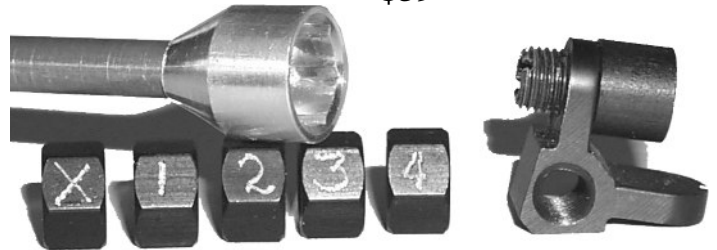

OLYMPIC ARMS DETACHABLE SIGHT SYSTEM.

Quality detachable sights at a reasonable price. They are both manual flip-ups, made from billet aluminum and steel. All USA manufactured.

MASS. Full set, front and rear: \$223⁰⁰

MARS. Multiple Aperture rear sight. \$166⁰⁰

DFS. Detachable Front Sight.

Manual flip-up front. **\$65⁰⁰**

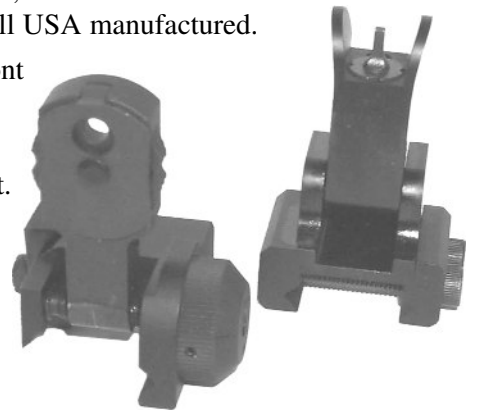

T22. EJECTION COVER ASSEMBLY

Includes all new: Ejection cover, ejection cover spring, hinge pin and hinge pin (C) clip.

\$11⁰⁰



AR-15/PCR PARTS

Introducing Blak-Tac. Blak-Tac is a “State of the Art” metal treatment process that produces a metal permeated black surface, does not add dimensionally to the piece being treated, and is *harder than hard-chrome!* Completely replaces the need for chrome plating, with no risk of cracking or flaking *ever*, because it is not a coating! Stronger, more lubrous, easy to clean and longer lasting than any chrome carrier. AND, it is tactical, not a bright white part, on a black gun. *Now standard in all Olympic Arms rifles and carbines.*

T24A. BLAK-TAC BOLT CARRIER ASSEMBLY \$118⁰⁰

T24A Includes: Forward Assist bolt carrier, gas key with two hex headscrews, Cam pin, Firing pin, Firing pin retaining pin, Complete bolt. 100% assembled and ready to go. *Don't forget to check your headspace!*



T26. BOLT, COMPLETE Chrome Bolt not available as separate component. **\$52⁰⁰**

FLASH SUPPRESSORS

A1

A2



F2A. BIRDCAGE
(A1 or A2)
F2A-A1.
F2A-A2.

\$5⁹⁵

F2B. VORTEX-
One of the best. Supplied to our military.

\$53⁰⁰

F2C. PHANTOM
Some say just as effective as the Vortex, but stronger, and with no open-ended prongs, and **LESS EXPENSIVE**

\$39⁰⁰

F2MB. POST-BAN MUZZLE BRAKE

\$30⁰⁰

Olympic Arms own design post ban muzzle brake, made specifically for PCR rifles. Attaches using 4 set screws.



T27. LOWER RECEIVER PARTS SET (ALL NEW)

Includes all parts to complete a stripped lower receiver less the butt-stock.

\$62⁰⁰ with grip

\$56⁰⁰ without grip



M16 parts only available with proper ATF Documentation. No Exceptions.

F3 PISTOL GRIP Assembly: Includes new pistol grip, screw and washer.

F3A. A2 style stowaway grip assembly \$10⁰⁰

F3B. GI style— \$8⁰⁰

F3E. Ergo® Brand grip. \$25⁰⁰



H8. Front Conversion Pin \$7⁰⁰

This is the conversion pin needed when using GI spec uppers with Colt's® manufactured lowers.

H8B CONVERSION BUSHING

No longer available. If you buy an Olympic Arms or any other GI mil-spec product, you will never need one anyway!



H15. Anti-Walk Pins \$7⁰⁰

Often used on full autos or needed for old worn out lowers. These headed pins are “captured” with a “C” clip on the opposite side of the lower to prevent the “walk-out” of both the hammer and trigger pins.

H11 AR FIELD KIT

Package includes: hammer and spring, firing pin and retaining pin, extractor and spring, disconnecter and spring, buffer detent and spring, 2 gas tube roll pins, gas rings (set of 3). Fits in pistol grip. A must for emergencies!

\$38⁰⁰



AR-15/PCR PARTS

M4S: M4 STYLE HANDGUARDS



M4 Style Polymer handguards with single black heatshield liners. Terrific upgrade for any carbine you may already have. Give it that current military M4 look!

\$22⁰⁰

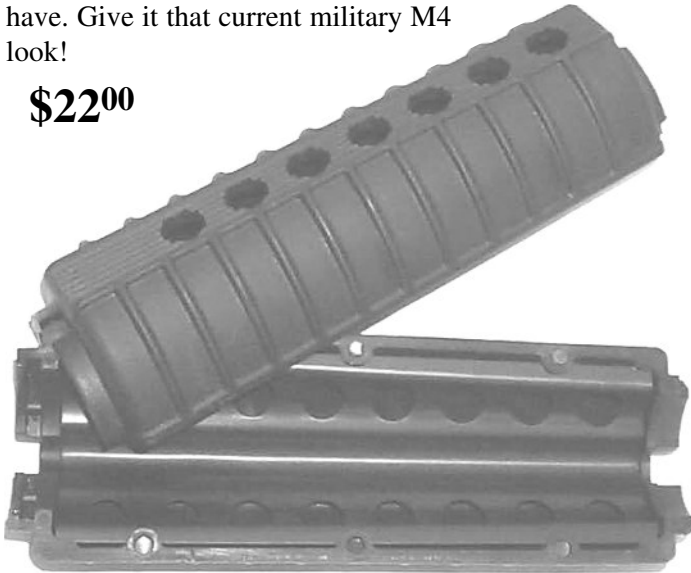

Harris Bi-Pods

The Official Bi-Pod of Olympic Arms

HBP-1. HARRIS BIPOD The standard of the industry.

Harris bi-pods mount to our match handguards via a standard bi-pod stud, standard round plastic handguards using the #5 Universal Bi-pod adapter (available below), or the Olympic FIRSH rail handguard system using the BPM (also sold below) and provides a built-in bench rest for superior handling and accuracy in any situation. Spring-loaded to swing up out of the way, adjustable for height and angle. No target style AR style rifle should be without one.



\$66⁰⁰

HBP-S. S-SERIES BIPOD. Articulate, or swivel to allow for the leveling your rifle on uneven ground.

\$83⁰⁰

HBP#5 Harris #5 Universal Bi-Pod Adapter \$11⁰⁰

F6. AR15/M16 A2 RIFLE HANDGUARD

\$18⁰⁰



F9. CAR-15 HANDGUARDS

Plastic handguards with aluminum heat shields.

\$18⁰⁰



F4 GAS TUBES – Made out of stainless steel tubing

A. CAR-15 – **\$13⁰⁰**

B. Standard – **\$16⁰⁰**

F5A. Complete Delta Ring Assembly

Delta ring, weld spring and snap ring – **\$17⁰⁰**



AR82. \$17⁰⁰

AR82FA (Full-Auto) \$19⁰⁰



NEW FOR 2003

WG. The "Wedgie"



Our little red friend that fits in the rear of your lower receiver giving your AR style rifles the tighter fit you may desire. Usually not needed on an Olympic product with forged receivers, but quite handy on most others. These have averaged \$3-\$4.00 each for years. Not any more.

WG. Bulk Packaged

1-9 \$1.50ea.

10-99 \$1.25 ea.

100+ .99cents

WG10. Retail 10 packs:

Attractively vacuum packed in lots of ten.

1-9 \$13⁵⁰

AR-15/PCR PARTS

T30. CARBINE BUTTSTOCK ASSEMBLIES

Assemblies include all new parts necessary to install on a stripped lower receiver, or to switch from an A2 stock to a carbine type. **NOTE: Collapsible stocks only legal on grandfathered pre-ban assault weapons.**



Aluminum M4 Stock!!

NEW LOW PRICE!!!

T30AM4 (collapsible) **\$83⁰⁰**

T30AM4NC (non-collapsible) **\$95⁰⁰**

NEW M4 Plastic Stock!

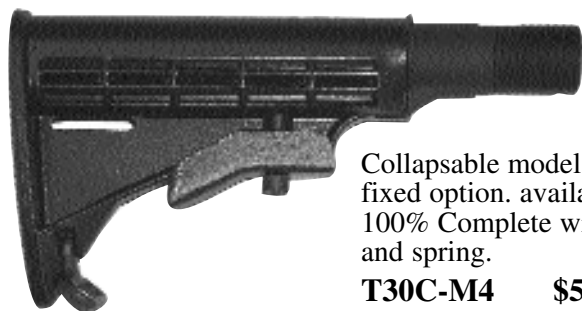

Collapsible model only. No fixed option. available. 100% Complete with buffer and spring.

T30C-M4 \$59⁹⁵



T30NC.

Fiberite fixed carbine stock (for post ban use).

\$83⁰⁰

T30AM4.	Aluminum M4 Style	\$83⁰⁰
T30B.	Aluminum M4 Style stock and latch only	\$39⁰⁰
T30C.	Hard Fiberite plastic stock assembly	\$43⁰⁰
T30D.	Extra length (1") tube with 4-hole adjustment add	\$6⁰⁰
T30NC.	Non collapsible plastic-fiberite stock assembly.	\$83⁰⁰
T30AM4NC	Non-collapsible M4 aluminum assembly	\$95⁰⁰

H13 BLACK NYLON SLING
1" GI style nylon sling with buckles.

\$4⁰⁰



T31 STANDARD TRAPDOOR BUTTSTOCK ASSEMBLY - A2



\$72⁰⁰

Includes all new parts necessary for stock installation: buffer, buffer spring, standard trapdoor stock, receiver extension tube and screw.



T30D. \$30⁰⁰

1.25" extended, 4-position collapsible stock receiver tube only. Not just a standard length 4-position tube. **Actually longer than other manufacturers 6 position tubes!**

H24 STOCK SPACER KIT FOR AR-15 **\$10⁰⁰**

Add one full inch to your AR15/M16's length of pull. Used on a standard A2 buttstock.

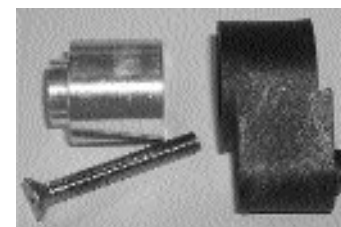

H125.

A 5 round magazine for your 5.56-223 AR style rifles. Great for bench rest use or for hunting.

\$16⁰⁰

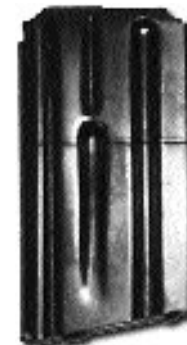

H12.

10 Round magazine.

\$14⁰⁰

GF. Green Followers. **Only .79 each!**

The popular improved green follower for GI 30 round AR magazines. Improves feeding, reduces failures. All 30 round mags should have one.

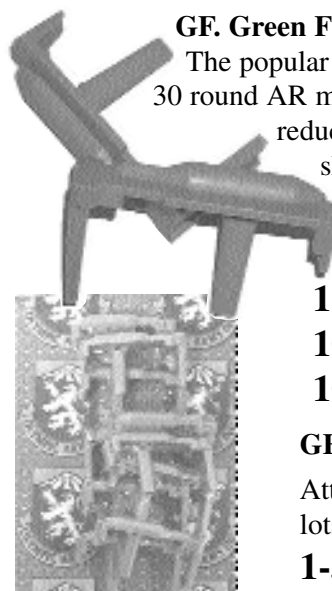

Bulk Packed

(pre-packed in 100 lot bags):

1-9	\$1.50ea.
10-99	\$1.25 ea.
100+	.99cents

GF10. Retail 10 packs:

Attractively vacuum packed in lots of ten.

1-50 \$13⁵⁰

AC4 PNEUMATIC RECOIL BUFFER

Tried, Tested and Proven

AC4 Olympic Pneumatic Adjustable Recoil Buffer

Born out of military testing, this recoil buffer completely eliminates the need for the standard recoil spring and buffer found in all AR15/M16 variants. The AC4 is adjustable so that one model can now be utilized on .223/5.56 cartridges, pistol caliber units, or any number of alternative rifle cartridges.

This air-charged buffer is tested from - 60°F to +140°F, and works without a problem. No messy leaks like similar hydraulic products that have historically proven to fail. This unit has reduced the cyclic rate of a military M4 Carbine from approx. 620rpm to 460rpm, while at the same time improving reliable feeding, extracting and ejecting.

Also great for CMP/Hi-Power rifles to reduce recoil and muzzle climb, and increased reliability during matches. And now with the ability to adjust the buffer to suit your individual needs, the AC4 is now a tool that can be used to give you the edge over the competition that you have been looking for .

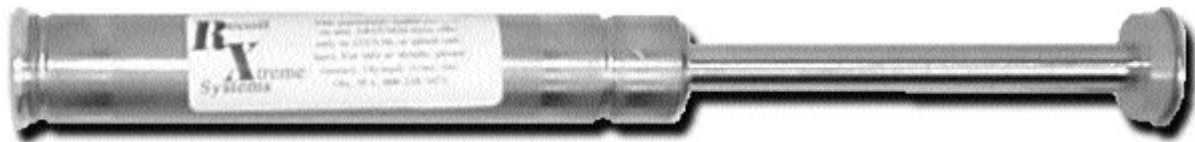

Installation is quick and easy. Simply remove your antiquated GI buffer system, and replace it with the NEW AC4 pneumatic buffer as shown above. Installation will take a whopping 30 seconds! No tools required!

Now Adjustable!

Now the AC4 is adjustable using a hex-head screw in the face of the buffer.

The pneumatic buffer can now be used on AR style rifles chambered in rifle or pistol cartridges!

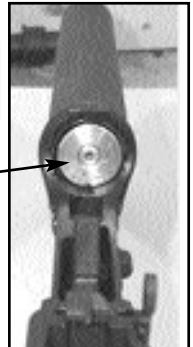

Benefits of the AC4 Recoil Buffer:

- *Reduced Cyclic Rate*
- *Improved Reliability*
- *Complete Elimination of Recoil Spring Noise!*
- *Reduced Recoil*
- *Reduced Muzzle Climb*
- *Faster Second Shot Sight Acquisition*
- *Lighter Weight*

Fully adjustable!

**AC4 Recoil Buffer
Only: \$129⁰⁰**

FIRSH System Handguards

(Free-floating Integral Rail System Handguard)

The FIRSH Handguard.

Starting with an *aluminum extrusion*, the **FIRSH** handguards derive a portion of their name from the fact that the rails are "Integral" to the handguard tube itself. *The rails are not a separate piece that is threaded onto, or in some other manner attached to the tube. They are a physical part of the tube.* This prevents the interference of any screws or bolts, and *adds considerable over-all strength* to the tube itself. As seen to the upper-right the FIRSH handguard has a unique locking mechanism that allows for positive positioning of the rail tube in any direction you desire.



PCR-8 with F7R FIRSH handguard and Harris Bi-pod.



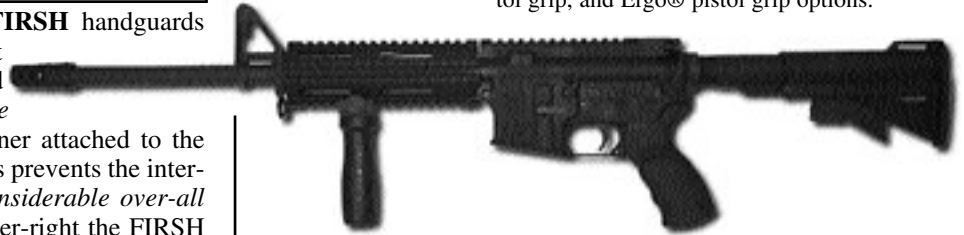

A CAR-97FT with F8R FIRSH handguard, vertical pistol grip, and Ergo® pistol grip options.

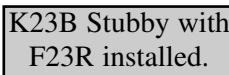

Oly Fact!

Did you know that Olympic Arms was the first AR manufacturer to offer the free-floating aluminum handguard?

FIRSH ON PATROL: Here is a photo of a soldier recently returned from duty in the Philippines. As you can see, the FIRSH rail handguard system is well accepted, and in use in our military forces world wide. Our soldiers expect the best, why should you accept anything less.

	F23R Pistol/SBR Length	
	F8R Carbine Length	
	F85R mid-length	
	F7R Rifle Length	
	F8LCR Fully covers 16" bbl.	

F7A. Aluminum Free-Floating Match Handguard \$5200

This two-piece tubular handguard comes as a complete assembly including a separate barrel nut and aluminum tubular handguard. Knurled in the center for sure grip.



F8A. Aluminum Free-Floating Match Handguard for Carbines

This handguard allows your carbine barrel to float the barrel without external pressures. Knurled in center. Two-piece construction like F7.



F23A. Aluminum Free-Floating Match Handguard \$3600

Just like the F7 and F8 models, but cut short for 6.5" barrel assemblies. Knurled in center, with 2-piece construction. Made from an aluminum extrusion for maximum strength, and lightweight.



FIRSH PRICING.	LENGTH	FITS
F23R \$78 ⁰⁰	3.625"	6.5" bbls on AR pistols, and SBR's.
F8R \$99 ⁰⁰	7.125"	16" barrels and all standard carbines.
F85R \$124 ⁰⁰	8.624"	Mid-length barreled carbines.
F7R \$129 ⁰⁰	12.5"	20" barrels and all standard H-Bar rifles.
F8LCR \$155 ⁰⁰	16.25"	Fully covers 16" bbls.

FIRSH ACCESSORIES

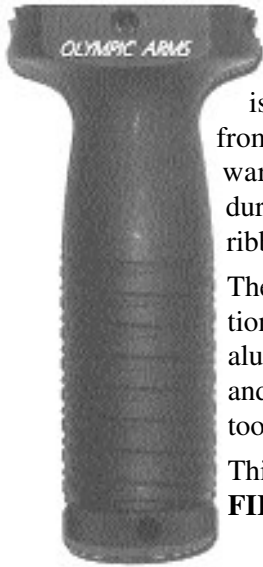

VPG.

The Vertical Pistol Grip. This unit is FIRSH handguard ready. Machined from billet aluminum, this tactical forward vertical pistol grip is strong, durable, ergonomically contoured, and ribbed for a positive purchase.

The VPG locks into place at any position on the handguard utilizing a solid aluminum shaft with serrated lock nut and holes for spanner wrench or other tool for extra tight lock.

This is a *must have* for every unit with a **FIRSH** handguard.

\$47⁰⁰

FLM.

This compact little unit is a flashlight mount cut specifically for the super popular Mini-Maglites®. Mini-Maglites® may not put out a million candle power, but they are a sub \$10.00 item, and everybody has one! Again, this will mount anywhere along your FIRSH handguard rail. Machined from solid aluminum with steel insert and rubber “O-Ring” for secure locking of the Maglite®. As with all our other components, this unit is emblazoned with the Olympic Arms name on the side as shown. **\$32⁰⁰**

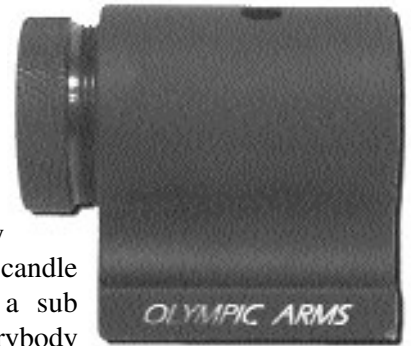

SR1.

The best, most versatile scope rings on the market. AR-15 style/PCR picatinny flat top rifles and upper. These rings are milled from solid billet aluminum, attach using quick-detachable locking screws, and are cut for 30mm scope tubes, but are uniquely outfitted with 1” inserts! **\$95⁰⁰**



\$95⁰⁰

F11. Detachable carry handle. This unit is that standard detachable carry handle unit, but comes with match grade sights. Can be used on any picatinny flat top upper receiver unit. Also, this unit can be mounted directly to the FIRSH handguard for a “Scout” type sighting system. This is becoming a popular option for iron sight competitors.

Picatinny Rail Mounting Adapters

BPM. Bi-Pod Mount. CNC machined from solid aluminum extrusion, this unit can be used as either a bi-pod adapter (as shown with a Harris S-Series bi-pod at right) OR as a side sling adapter. Outfitted with 2 set screws for a no-nonsense lock-down, and a steel bi-pod stud for attaching of either the bi-pod or sling adapter.

NEW LOW PRICE! \$22⁰⁰

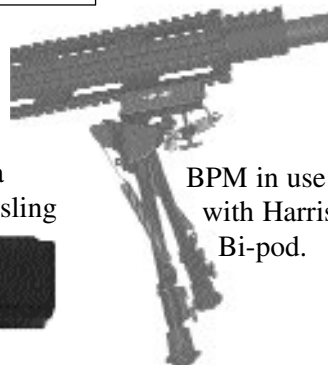

BPM in use with Harris Bi-pod.

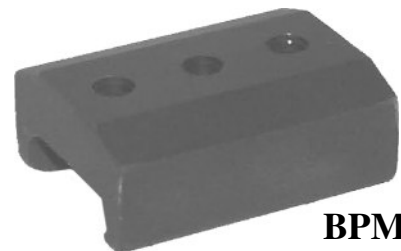

BPM-S

The BPM-s model is an all aluminum picatinny rail mount suitable for use in mounting side sling adapters

\$20⁰⁰

ERGO BRAND ACCESSORIES

F10. Tactical Pistol Grip Assembly \$53⁰⁰

While the tactical pistol grip has been in our catalog, this year's model is slightly different, and warrants mentioning. Manufactured with a solid plastic core and then coated with a soft stippled rubber surface, this is the best we've found. Adjustable palm shelf standard. Comes complete with new hex-head pistol grip screw.



F3E. Ergo® AR Pistol Grip

Just like the name implies, this AR15/M16 pistol grip is ergonomically designed to improve grip and comfort for the shooter. *Now available in a rubber coated Sure Grip design!*

- F3E: Right hand**
- F3EL: Left hand**
- F3EA: Ambidextrous**
- Your Choice: \$25⁰⁰**
- F3ESG: Rubber coated Sure Grip \$30⁰⁰**



AC5. The "Gapper" Rubber Trigger Guard Plunger

An inventive product manufactured by Falcon Industries (manufacturers of the fine Ergo Grip products), the gapper fills a genuine need, and a genuine space. This comfortable small rubber plunger inserts into the space between the back or the trigger guard, and the front of your pistol grip. Installs with ease before or after pistol grip installation.



AC5
\$39⁵ ea.



ACRKS: \$13⁰⁰
Accessory rails can be cut to any length.

Accessory Rail Kit: Attaches to standard military style handguards. Gives your handguards a picatinny rail for the mounting of all sorts of accessories, including the VPG!



AC2L-3P



AC2-3P



AC2-2P



AC2

AC2L

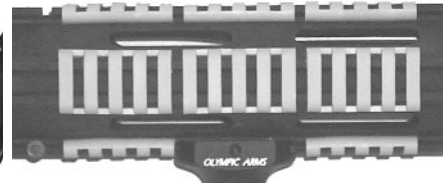

AC2 Rail Panel Covers

NOTES: It takes 3 single panel AC2's to fully one rail of a carbine length handguard. One dozen individual panels will cover an entire carbine handguard. One AC3-3P will do the same job s 3 AC2's. The AC2L-3P can be cut to any custom length with any utility knife.

AC2 Rail covers are a pliable, yet rugged vulcanized rubber panel cover for any standard Picatinny rail system. They work especially well on the FIRSH handguards! *Now available in Black, OD Green, or new Coyote Brown! Save by the dozen!* Please specify color when ordering.

- AC2 \$3⁰⁰⁰ ea.**
- AC2D \$3²⁰⁰ (dozen count)**
- AC2L. \$3⁰⁰ ea.**
- AC2L-3P \$9⁰⁰ ea. (3-panel size)**
- AC2LD \$3²⁰⁰ (dozen count)**
- AC2-2P \$6⁰⁰ ea. (2-panel size)**
- AC2-3P \$⁰⁰ ea. (3-panel size)**
- A2VP: \$3²⁰⁰ (variety pack)**



AC2VP: Variety Pack. Enough to cover a full carbine length FIRSH handguard giving you a variety of options for covering your handguard.
\$32⁰⁰

AR-15/PCR PARTS

NEW ESpring TECHNOLOGY

New spring technology has been sought and Olympic Arms has provided that technology - **ESpring** Technology. **ESpring**® technology combines the latest in engineering expertise and metallurgy. New metal alloys are now available allowing results never before imaginable. These springs may cost more than you are used to paying for similar parts, but it is a small price to pay for the security and piece of mind that these products will give you.



MAGAZINE ESpring

This Titanium magazine spring will not take a set or collapse under pressure. Leave your mags loaded for years without worry. **Load 'em and forget 'em!** Only available in 30 round configuration.

ESMAG \$15⁰⁰ ea.
-or- \$140⁰⁰ per doz.

(spring only, does not include 30 round magazine body.)

ESpring 223/5.56 Ejector Spring



Made from a proprietary alloy material, this ejector spring is absolutely the best available. Tested by the military in the most adverse and stressful situations imaginable, this ejector spring never failed, even after 9,000 rounds of sustained fullauto fire!

ESEJ \$5⁰⁰ each **ESEJD \$54⁰⁰ per dozen**

UNIVERSAL COMPRESSION WASHER

This compression washer replaces the need for the expensive and sometimes hard to use peel washers needed to install flash hiders and muzzle brakes that require indexing. Use the UCW with any muzzle brake or flash hider, thread the unit on, align it as needed, and you are done!



Reusable multiple times even after being torqued on! **AR42C \$4⁰⁰ EACH**
AR42CD \$45⁰⁰ doz.

THE ERING ONE-PIECE GAS RING

More ESpring® Technology! This one-piece gas ring is made from a proprietary material that will withstand the most torturous conditions. The ERing's® single piece construction prevents gas ring alignment (allowing for gas pressure leakage), making any AR16/M16 more reliable.



AR11B.
\$720

Guaranteed for 10,000 rounds!

EXring Polymer Extractor Assist

The EXring is a vast improvement over similar products. The EXring is "X" shaped (see cut out photo to the left) and will give that extra strength to your extractor many ARs need. If you are having extraction problems, this is the answer.



EXRING \$15⁰⁰ each
25 for \$24⁰⁰

HTU KIT

Called the High Tech Upgrade (HTU) kit, this bag of small parts will make a significant improvement



in any AR's reliability. Contains the following:

- 1ea. Universal Comp. Washer (AR42C)
- 2ea. ESpring 223/5.56 Ejec. Spr. (ESEJ)
- 2ea. ERings 1-piece gas rings (AR11B)
- 5ea. EXring poly extractor buffers (EXRING)

HTU \$30⁰⁰



Pictured here installed on an extractor spring.

THE TRI-POD GRIP

It's a tri-pod. No, it's a vertical pistol grip. No. It's both!

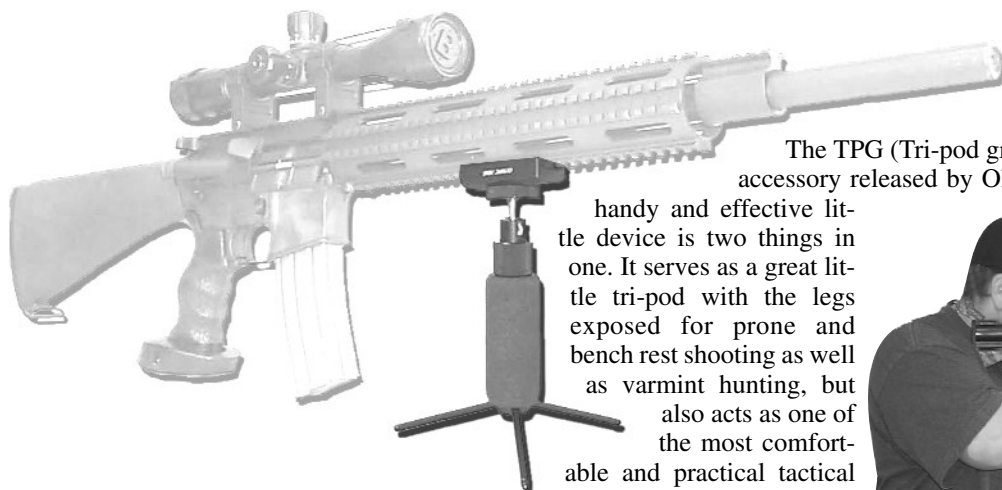

handy and effective little device is two things in one. It serves as a great little tri-pod with the legs exposed for prone and bench rest shooting as well as varmint hunting, but also acts as one of the most comfortable and practical



vertical pistol grips available on the market today. Shown here supporting a (ghosted) PCR-1P rifle, the TPG is strong and dependable as a tri-pod, and works just as well as a vertical pistol grip. At right we see the other use for the TPG; that of a vertical pistol grip. Shown here with Olympic Arms sales person Don Teague utilizing the TPG on an in-house demo-model K23B Stubby "SD" model outfitted with a Holosite provided by Industry Partner Bushnell® (also notice the excellent Bushnell Tactical optic on the PCR-1P above). In this case the TPG is mounted to a FIRSH rail handguard using the supplied rail mount. This mount is machined from a solid aluminum extrusion, and attaches via 2 hex-head set screws.

THE TPG HAS SOME AMAZING FEATURES:

- Retractable legs that store inside the body of the grip
- Steel ball-joint for strength
- All aluminum body construction for light weight
- Fully adjustable for panning, articulation & elevation adjustments all with one lock!
- Adjustable tensioner for full lock, or loose for manual target compensation adjustments *while shooting*
- Knurled locking collar for secure locking
- 360 degree adjustability!
- Comfortable foam rubber grip



These photos only begin to show you the versatility of the TPG's. The top pic shows the TPG folded, neatly tucked out of the way underneath the barrel assembly of a PCR-1P rifle. The other photos simply show you how the legs of the TPG fold up and then slip securely into the body of the TPG itself, completely out of the way, but ready for deployment at the snap of your rifle! The TPG is a must have for any AR owner.

TPG-S Short Model



TPG-L Long Model



Your Choice:
\$59⁹⁵

Get your choice of either the BPM bi-pod mount, or the SSM (side sling mount) when ordering your TPG. Either model will work splendidly for mounting your TPG. The BPM also doubles as a full size bi-pod mount for the Harris models, and comes with a bi-pod stud attachment. SSM mount does not come with bi-pod stud. No discounts when no mount is requested. Sold separately on page 38.

With standard 1/4x20 threads, the TPG also makes an excellent tripod for cameras, video recorders and spotting scopes!



ACE® BRAND SPECIALTY STOCKS



ACE LTD. USA
High Performance Firearm Parts & Accessories Lifetime Warranty

Bob Weir CEO of Ace Ltd. USA is the creator and innovator of the skeletonized “FX” stocks on the market today. At Olympic Arms, we carry only the

original Ace® brand products. No copies, no foreign imports. All original Ace® products with a lifetime warranty. Simply the best.



Shown above: CAR-97M4 with Ace® FX Stock part #T32

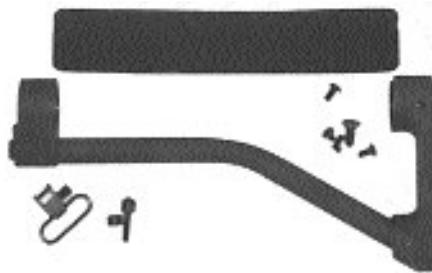

T32. Ace Stocks “FX” AR15 butt-stock. Bolts directly onto any AR rifle or carbine with A2 stock assembly.

\$79⁹⁵

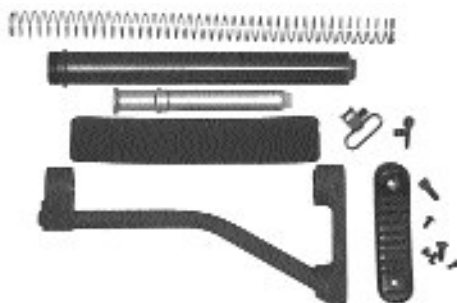

T32A. Ace “FX” Stock assembly. All the parts you need to switch from a collapsible stock, or to outfit a stripped receiver.

\$99⁹⁵



Shown above: StubbySD with Ace® “FX” Stubby Stock Part #T32S

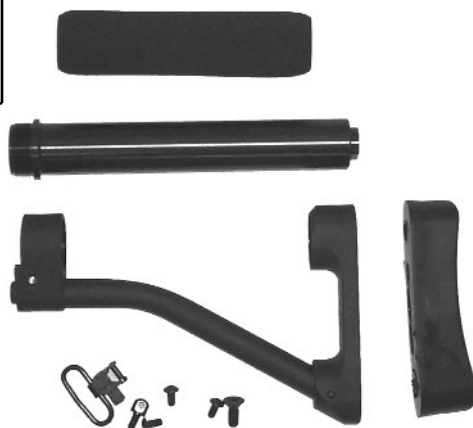

T32S. Ace “FX” Stubby Stock. Same as part #T32, but in a short “entry” length.

\$99⁹⁵

T32SA. Ace FX Stubby stock with recoil buffer & spring. Full assembly for stripped lower.

\$119⁹⁵



Shown above: CAR-97M4 with Ace® Ultralight Stock Part #T32UL



T32UL. Ace Ultralight Stock for lower with A2 stock.

\$74⁹⁵

T32ULA. Ace Ultralight stock; full assembly with receiver tube, recoil spring and buffer.

\$99⁹⁵



Shown above: CAR-97M4 with Ace® Ultralight Stubby Stock Part #T32ULS



T32ULS. Ace Ultralight Stubby stock. Short entry length lightweight stock.

\$89⁹⁵

T32ULSA. Full ULS assembly with recoil spring and buffer.

\$104⁹⁵

PROP-GUN & PRO TRAINING AIDS

In today's firearms market there is a great trend towards training and security. There is also a growing market base in the Hollywood movie prop gun business. Olympic Arms has been supplying true firing weapons, blank firing weapons, and movie prop-guns for years. You probably have already seen some of our product such big-screen features as *Clear and Present Danger*, *Eraser*, *Batman Returns*, *Bad Boys*, *The Professional*, *The Rock* and more. We hear frequent comments from those studios that rent and purchase our firearms for their unique quality and ruggedness. As a matter of fact, Hollywood's biggest prop rental house Independent Studio Services prefers the Olympic prop-guns over any they have ever used! To meet this ever growing replica demand, Olympic Arms is not cataloging some standard prop-guns.

Prop-guns also make great replacements for the replica blue guns. Our prop guns give you the feel, looks and weight of the real thing without tying you down to FFL transfers. Great for trade shows and catalog photo shoots, when packing a real firearms can prove to be logistically difficult if not impossible. Olympic Arms prop guns are now being used by such companies as *Blackhawk Industries*®, *Quake Industries*®, *Falcon Industries*®, *Laser Devices*® and many more.

These are non-firing museum quality replicas. They are non-guns and do not require an FFL for purchase or transfer. They make great wall hangers and conversation pieces for those people who do not want to own the real thing, or simply like to collect replicas. They don't get any more detailed than these, without actually working!

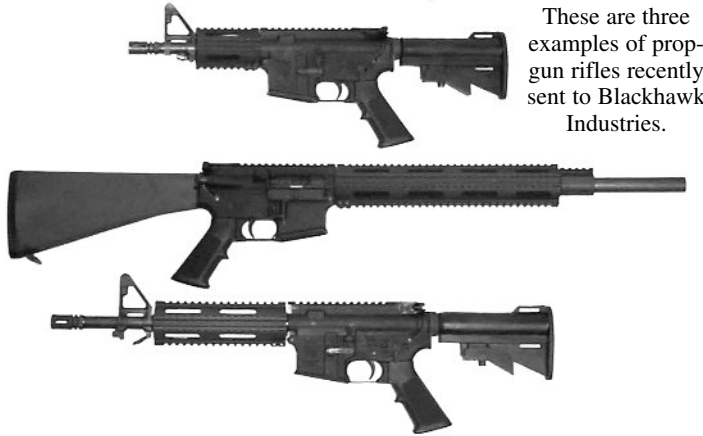

These are three examples of prop-gun rifles recently sent to Blackhawk Industries.

Almost any imaginable option available!

Because of the specialized uses of prop-gun replicas, almost any option is available, as well as the installation of customer supplied parts (some modifications may be necessary).

Pricing varies based on the required options of the replica. As an example, here are some basic standardized prices:

CAR-15	\$395⁰⁰	Call for price quotes based on your needs.
Standard M16A2 replica	\$425⁰⁰	
M16-M4A3	\$595⁰⁰	

Training Aids

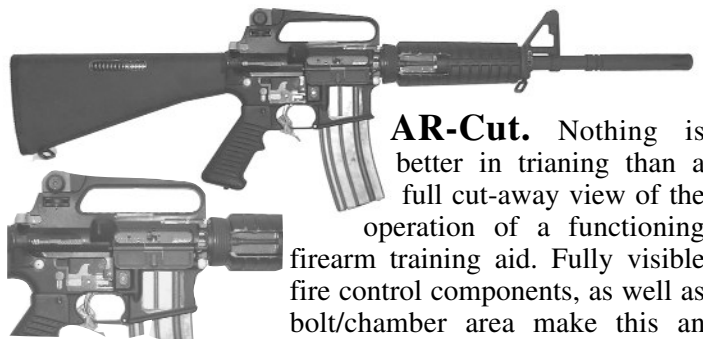

AR-Cut. Nothing is better in training than a full cut-away view of the operation of a functioning firearm training aid. Fully visible fire control components, as well as bolt/chamber area make this an excellent training aid for any

agency or department. Cut-away, yet fully functional, this is an FFL transferable weapon.

\$1,375⁰⁰

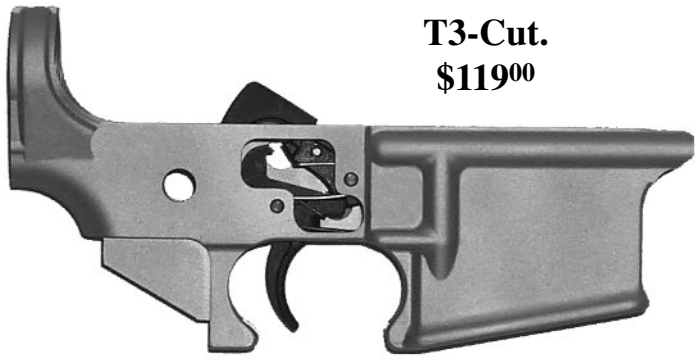

T3-Cut.
\$119⁰⁰

T3Cut. The T3-Cut is a training aid cut-away blank (*non-gun*) lower receiver forging that has been milled to accept the fire control components for training with regards to hammer/disconnector/trigger engagement, as well as for fitting and tuning of custom triggers. Drilled to mil-spec dimensions with regards to trigger components. *No FFL required.*



1911 Cutaway
\$1,245⁰⁰
(series 70)

1911-Cut. As detailed and functionally beautiful as the AR-Cut, this fully functional training aid is the only way to teach the 1911 handgun to beginners and pros alike.

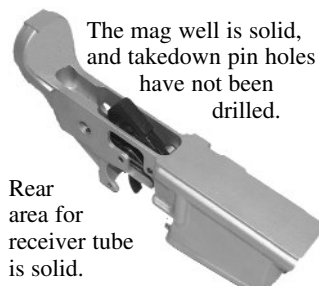

Rear area for receiver tube is solid.



The mag well, and takedown pin holes have not been drilled.

A-2 REAR SIGHT ASSEMBLY T-15

Sold as a unit on page 27. For individual small parts, see below:

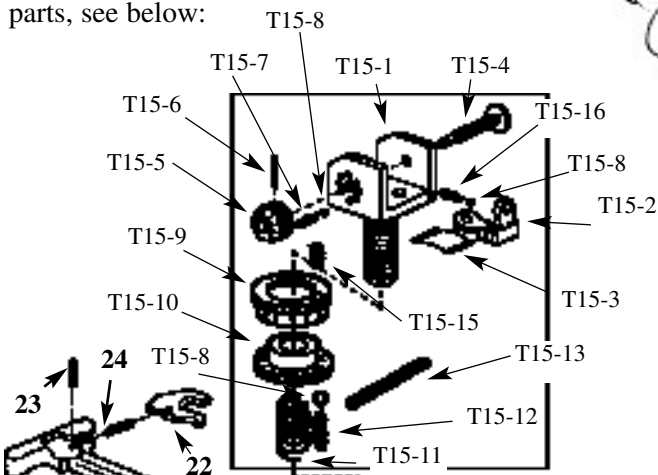

BOLT AND BOLT CARRIER ASSEMBLY

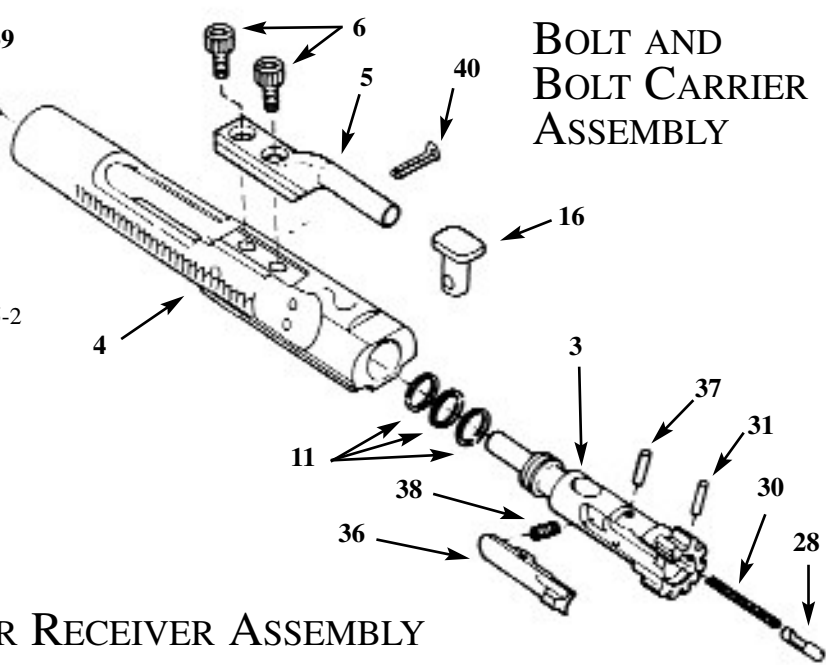

UPPER RECEIVER ASSEMBLY

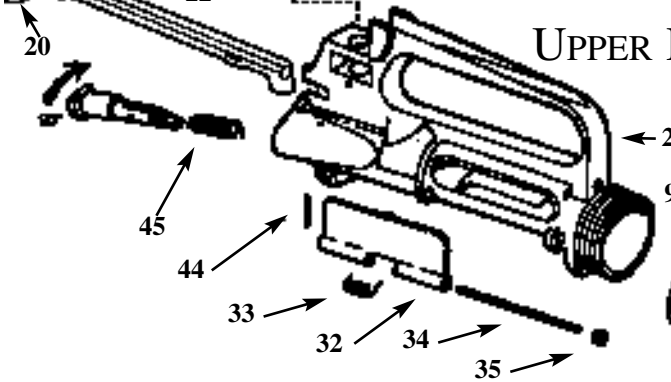

BARREL ASSEMBLY

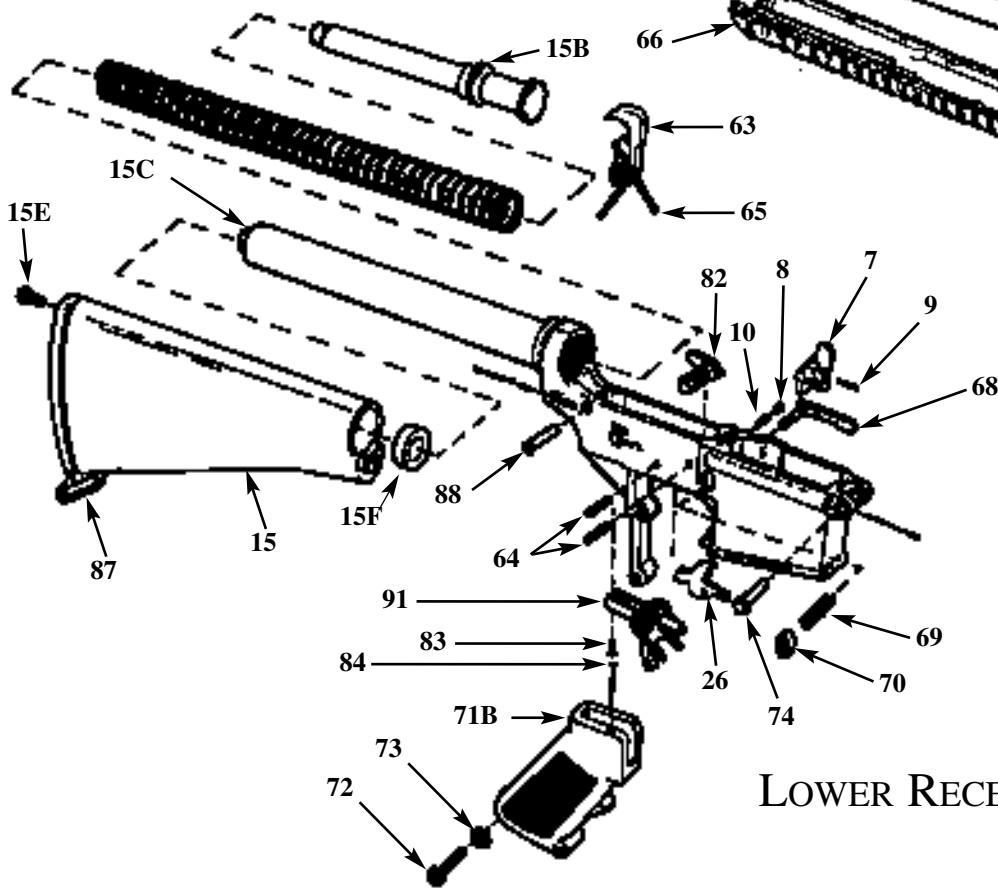
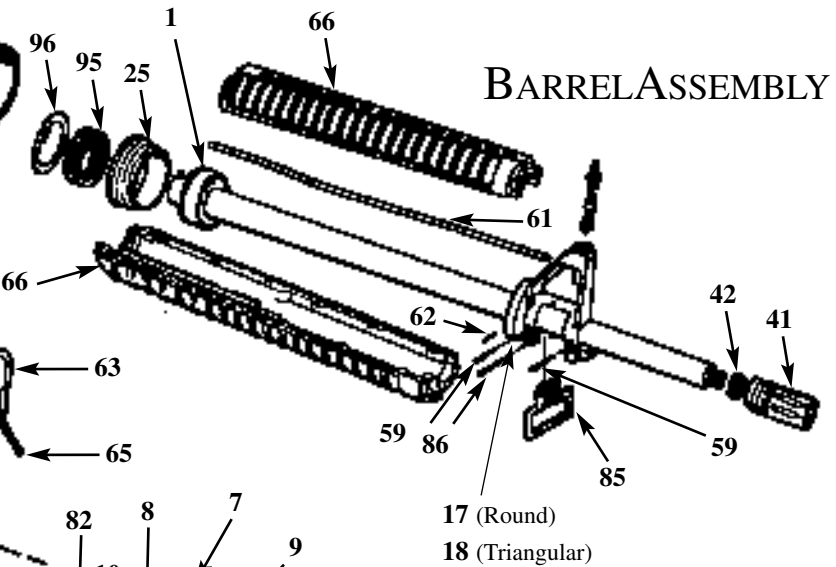

LOWER RECEIVER ASSEMBLY

AR-15 STYLE REPLACEMENT PARTS

AR1	Barrel nut.....	\$14.00	AR62.	Gas tube roll pin.....	.80
AR2	A2 Upper receiver, stripped.....	93.00	AR63.	Hammer.....	13.00
AR3	Bolt, complete (223/5.56 cal).....	52.00	AR64.	Hammer & trigger pin.....	1.00
AR3-9/10/40/45			AR64-H15	H/T pins; Anti-walk type (per set of 2).....	5.00
	Bolt, complete, pistol caliber.....	78.00	AR65.	Hammer spring.....	1.20
AR3-310	Bolt, Complete, 7.62x39.....	62.00	AR66.	Handguards (CAR) round w/o liners.....	11.00
AR4	Bolt carrier,.....	52.00	AR66A.	Handguard (CAR) round with liners.....	18.00
AR4FA	Bolt Carrier; Full-auto configuration.....	53.00	AR67.	Handguard snap ring.....	1.00
AR5	Bolt carrier key.....	11.00	AR68.	Magazine catch.....	5.40
AR6	Bolt carrier key screw.....	.75	AR69.	Magazine catch spring.....	1.00
AR7.	Bolt catch.....	7.00	AR70.	Magazine catch button.....	2.40
AR8.	Bolt catch plunger.....	1.00	AR71A.	Pistol grip assembly A2 stowaway.....	10.00
AR9.	Bolt catch roll pin.....	.80	AR71B.	Pistol grip (A2) only.....	9.00
AR10.	Bolt catch spring.....	.80	AR71C.	Pistol grip A2 (GI style).....	9.00
AR11.	Bolt gas rings, set.....	3.00	AR72.	Pistol grip screw.....	1.00
AR11B.	ERing 1 Piece gas ring.....	7.00	AR73.	Pistol grip screw washers.....	.80
AR12.	Buffer detent.....	1.50	AR74.	Pivot pin, front.....	6.00
AR13.	Buffer detent spring.....	.80	AR75.	A1 Rear sight.....	7.00
AR14A.	Butt stock buffer (CAR).....	14.00	AR76.	A1 Rear sight adjusting screw.....	3.00
AR14B.	Buffer spring (CAR).....	5.00	AR77.	A1 Rear sight detent spring.....	.80
AR14C.	Receiver ext. tube (CAR).....	22.00	AR78.	A1 Rear sight detent.....	.80
AR14C1.	Extra long (1") CAR receiver ext. tube		AR79.	A1 Rear sight leaf spring.....	.80
	4 position.....	30.00	AR80.	A1 Rear sight windage drum.....	4.00
AR15.	Butt stock (standard) complete.....	72.00	AR81.	A1 Rear sight windage drum roll pin.....	.80
AR15A.	Butt stock (standard) trapdoor.....	42.00	AR82.	Safety selector.....	13.00
AR15B.	Butt stock buffer (standard).....	20.00	AR83.	Safety detent.....	1.20
AR15C.	Receiver ext. tube (standard).....	20.00	AR84.	Safety spring.....	.80
AR15D.	Buffer spring (standard).....	5.00	AR85.	Swivel, front.....	5.00
AR15E.	Butt stock screw.....	1.80	AR86.	Swivel pin.....	.80
AR15F.	Stock spacer, A-2.....	1.80	AR87.	Swivel, rear.....	5.00
AR16.	Cam pin.....	5.00	AR88.	Takedown pin, rear.....	6.00
AR16A.	Cam pin, chrome.....	N/A	AR89.	Takedown pin detent, rear.....	.80
AR17.	Cap. handguard front (round).....	5.00	AR90.	Takedown pin detent spring, rear.....	.80
AR18.	Cap. handguard front (Tri.).....	5.00	AR91.	Trigger.....	13.00
AR20/T23.	Charging handle, complete.....	24.00	AR92.	Trigger guard.....	6.00
AR22.	Charging handle latch.....	5.00	AR93.	Trigger guard pin.....	.80
AR23.	Charging handle latch roll pin.....	.80	AR94.	Trigger spring.....	1.20
AR24.	Charging handle latch spring.....	.80	AR95.	Weld spring.....	6.00
AR25.	Delta ring.....	11.00	AR96.	Lock ring.....	6.00
AR26.	Disconnecter.....	5.00	AR97.	Receiver plate.....	3.00
AR27.	Disconnecter spring.....	.80			
AR28.	Ejector.....	4.00	A-2 SIGHT ASSEMBLY PARTS LIST		
AR30.	ESEJ Ejector spring.....	5.00	T15-1	A-2 Sight base.....	9.69
AR31.	Ejector roll pin.....	.50	T15-2	A-2 Sight aperture.....	5.49
AR32.	Ejection cover.....	11.00	T15-3	Leaf spring.....	1.10
AR33.	Ejection cover spring.....	.80	T15-4	Windage srew.....	2.39
AR34.	Ejection cover hinge pin.....	1.20	T15-5	Windage knob.....	3.59
AR35.	Ejection cover hinge pin clip.....	.80	T15-6	Windage knob roll pin.....	.50
AR36.	Extractor.....	12.00	T15-7	Windage knob spring.....	.50
AR37.	Extractor pin.....	1.20	T15-8	Ball bearing.....	.90
AR38.	Extractor spring; HD w/o insert.....	1.80	T15-9	Elevation wheel cap.....	4.20
AR39.	Firing pin, new.....	8.00	T15-10	Elevation adjustment wheel.....	4.20
AR40.	Firing pin retaining pin.....	.80	T15-11	Elevation base spring.....	.90
AR41.	Flash suppressor (A-2bird cage).....	5.50	T15-12	Elevation wheel ball-bearing spring.....	.25
AR42.	Flash suppressor lockwasher.....	1.80	T15-13	Sight base elevation lock roll pin.....	.50
AR42C	Universal Compression Washer.....	4.00	T15-15	Elevation wheel lock screw.....	.75
AR44.	Forward Assist. retainer pin.....	.80	T15-16	Sight base constant alignment spring.....	.50
AR45.	Forward Assist. spring.....	1.00			
AR55.	Front sight base.....	20.00			
AR56.	Front sight detent.....	1.80			
AR57.	Front sight post.....	4.00			
AR57A.	Square front sight post.....	5.00			
AR58.	Front sight post detent spring.....	1.00			
AR59.	Front sight taper pin.....	1.00			
AR60/F4A.	Gas tube (CAR).....	13.00			
AR60-PT.	Gas Tube; Pig-Tail type.....	42.00			
AR61/H4B	Gas tube (standard).....	16.00			

HIGH TECH UPGRADE PARTS:

HTU Kit	Full kit if high tech upgrade parts.....	30.00
ESEJ	Military tested 10K round ejector spring.....	5.00
AR11B	ERing 1-piece gas ring.....	7.20
EXRing	Poly X-ring extractor tensioner.....	1.50
ESMAG	Titanium 30 round magazine spring.....	14.00

Manuals

Military "TM's" Training Manuals

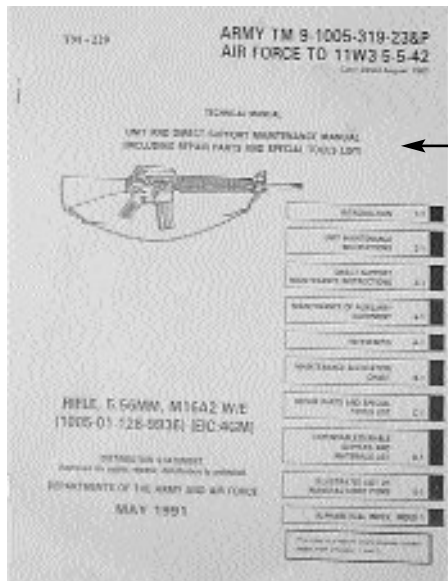

TM-220. A combo Army/Air Force manual. This manual, as with all military TM's is very detailed. Covers just the M16A2 standard issue rifle. **\$1200**

TM-225. A composite of Army TM 9-1005-319-23&P and the Air Force TO 11 W3-5-5-42. This is a very comprehensive manual and covers both the M16A2 and the M16A4 Carbine. **\$1500**

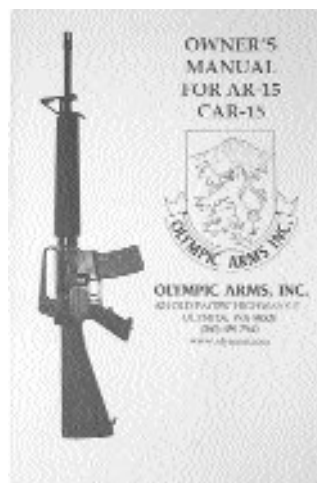
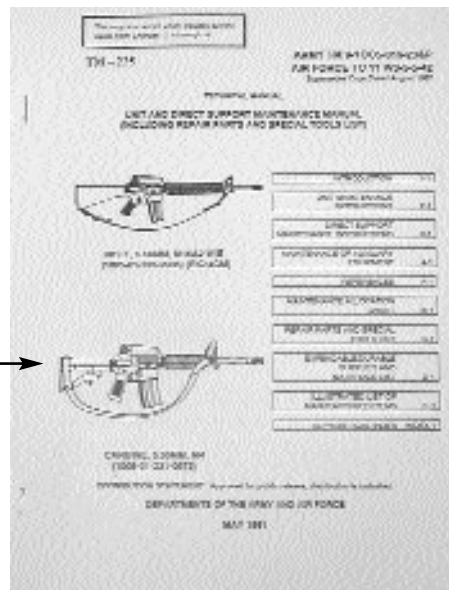

Man1. Olympic Arms Official AR/PCR Owners manual. This manual covers the basics of operations and ownership responsibilities. Reviews home maintenance, cleaning, upkeep etc. This is the same manual that ships with each and every rifle Olympic Arms manufacturers. No Oly owner should be without one. Great manual for new owners of used ARs as well. **\$400**



H7. Marine Corp Manual

A reprint copy of the USMC Technical manual. All you'll ever need to know about the AR15 series, from complete and total disassembly and reassembly to torque specs and beyond. If you own an AR you **NEED** this! **Only \$900**



Man2. Owner/operator manual for the Olympic Arms pistol caliber upper conversions.

This is a brief manual that covers the basic ins and outs of operating, maintaining and cleaning of the Olympic pistol caliber units. Has schematic diagram of pistol caliber parts, as well as references to out-dated magazines and blocks as well as other notable remarks. A must have for all owners of Olympic manufac-

tured pistol caliber conversion units.

\$300



Man3.

When Olympic first introduced the OA-93 pistol back in 1993, it took the market by storm, and still captivates those who own such a system, as well as those that desire to. This manual contains all the original OA-93 information including blow-up parts schematic with part numbers and descriptions, and contains all the references to most of the OA-93 series of weapons including the fixed magazine OA-96 model.

Same manual that ships with OA-93 uppers and OA-98 pistols today. **\$500**

PCR/AR GUNSMITHING TOOLS

H5. HEADSPACE GAUGES

A must have for any serious AR owner.

- H5A Go
- H5B No-Go
- H5C Field



Each **\$19⁰⁰**
 Set of 3 **\$50⁰⁰**

H20 ARMORER'S BLOCK KIT FOR AR-15 RIFLES -

Eliminates any possibility of damage to the upper receiver or barrel unit during torquing on or off of the barrel nut. Securely holds the upper receiver assembly in a polymer shell. Also includes a poly receiver insert to prevent possible receiver pinching. Works on either A2 uppers or A3 style picatinny flat tops. A must have for any serious AR shooter.

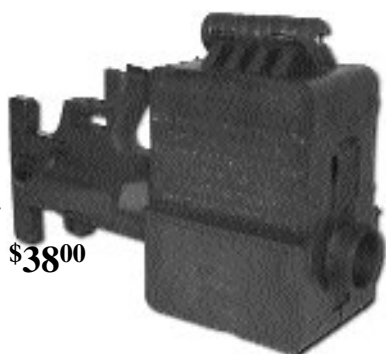

\$38⁰⁰

H3. COLLAPSIBLE CAR-15 STOCK WRENCH

A must have tool to tighten the lock ring on your collapsible stock receiver tube. Also works as a 1911 bushing removal tool.

\$4⁰⁰



This is no wimpy little wrench that's only good for one use, and then throw it away. This is a good strong little wrench.

H28 UNIVERSAL BARREL WRENCH

This wrench, designed and manufactured by Olympic Arms, is quite simply the best on the market at any price. The H28 has an integral handle for easy removal of barrels with either barrel nut, or a free float tube assembly. Equipped with the multi point head as well as a strong 3 point design. Machined with a 1/2" port for torque wrench for exacting specs. Notched for A1 or A2 flash hiders and receiver extension tubes. The H28 is capped with a collapsible stock spanner wrench and screw driver.



\$22⁰⁰

H2. Dual Slot Vise Jaw Blocks

Manufactured from an aluminum extrusion and designed to accept heavy or standard barrels. Will not accommodate bull barrels.

\$10⁰⁰



AC1. An excellent tool to add to your armorer's kit, or just to have around the bench. This specially designed AR15 chamber cleaning kit is just the ticket for quick, effective chamber cleaning.

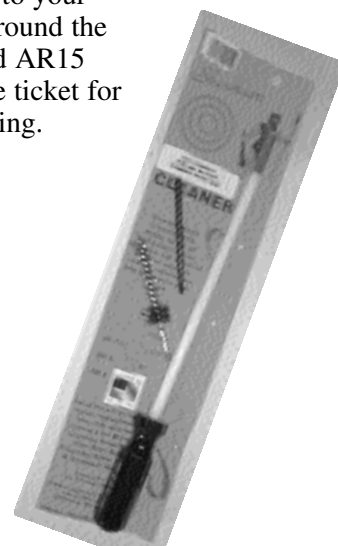

\$13⁹⁵

Sight Tools/Takedown Pin Punch

New Lower Price! **\$6⁵⁰ ea.**



- H4 SIGHT TOOL
(Specify 4 or 5 prong)
- H4A. 4-prong
- H4B. 5-prong

Full Size sight tools and Takedown Pin Punch

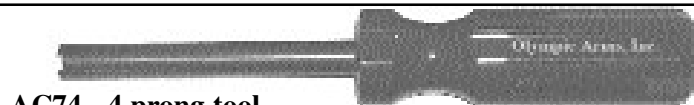

AC74 - 4 prong tool
\$11⁹⁸



AC75 - 5 prong tool
\$11⁹⁸

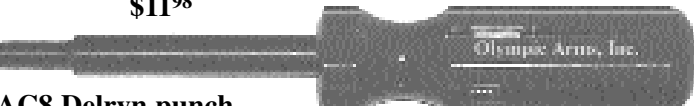

AC8 Delryn punch
\$6⁹⁸

PCR/AR GUNSMITHING TOOLS

FP-10 PRODUCTS



We just can't say enough good things about this product. It has a military stock number (NSN 6850-01-408-4351 4oz. bottles), and performed better than all other issued lubricants in the recent Iraqi conflicts. It meets all EPA standards (which some well known products do not), is used by Picatinny Arsenal, is a two time winner a *Gold Medal Best Value Award* by the Defense Supply Center, Richmond, VA. (DSCR), and has been in the USPFO system since 1998. FP-10 is so amazing, it is now recommended and sold by Cleanbore! (see testimonial below right)

"FP-10 is an amazing product. It is so much more than just an excellent cleaner and lubricant. It is the perfect product for barrel break in as it is a metal treatment (bonding to the barrel steel), and not just a lubricant. Even dry, FP-10 allows your weapon to function flawlessly. The most amazing thing that I found from my personal testing is that FP-10 reduced my shot string velocity variations by almost 80%! That is an amazing feat, and a very important factor in long range accuracy shooting of any type."

Tom Spithaler
Sales & Marketing Director
Olympic Arms, Inc.



FP-10 PRODUCT PRICING:

FP10-4	\$4.99	FP-10; 4oz. bottle/per each.
FP10-4C	\$55.20	FP-10; 4oz. bottles/case lot of 12 bottles
FP10-16	\$12.99	FP-10; 16oz. bottle/per each
FP1016C	\$127.99	FP-10; 16oz. bottles/case lot of 12 bottles
FP10-SP	\$1.49	FP-10; 16oz. bottle sprayers

Free sprayers with case lot purchase of 16oz bottles.

Free Sample!

We at Olympic Arms and MPC (the manufacturers of FP-10) are so confident that FP-10 is the best cleaner, lubricant, protectant that you will ever use, that we want to send you a free sample! That's right, absolutely 100% FREE of charge.

When you place your next order with Olympic Arms, just tell us you want your free sample of FP-10, and we will include that with your order FREE of charge!

We are confident that once you use it, and see the benefits of FP-10 first hand, that you will never use another CLP type "ointment" ever again!

[Even though FP-10 comes in a familiar looking packet, we do not recommend using it as a condiment.]



Testimonial

"After several months of field and laboratory testing in cooperation with both US forces domestically and overseas, and testing with local troops in the harsh, hot dusty desert conditions in Kuwait, Iraq and the United Arab Emirates we have arrived at the conclusion that FP-10 is a substantially better product than it's many rivals. FP-10 has performed flawlessly for us, and at every stage of the thorough evaluation process FP-10's performance was impressive. In the desert, the 'boundary film' technology allowed weapons to be fired 'dry' preventing sand and dust adherence, whilst still providing a 'boundary film' preservative coating to inhibit corrosion."

Brian Goldie
Chief Executive Officer
Cleanbore Ltd.
25 October 2003

OLYMPIC ARMS ACCESSORIES

OA7. OLY ARMS OD GREEN HARD CASE. Oly Arms proprietary Dorskocil Single rifle gun case. Upgraded for 2004! Emblazoned with the Olympic Arms name and logo, Molded in an military style Olive Drab green.



\$21⁹⁵

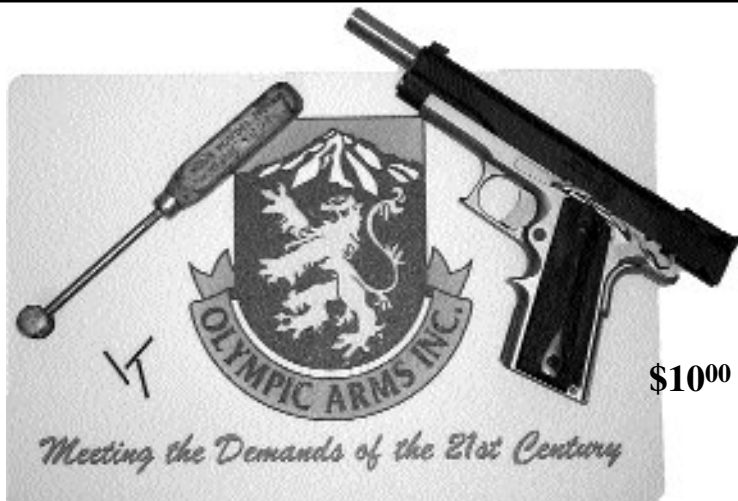

\$10⁰⁰

OA2. PATCHES

Four-color custom patch with lion logo.



\$3⁰⁰

OAM-7. OLYMPIC ARMS PIN
Our lion logo engraved in pewter.



\$4⁰⁰

OA4. Olympic Arms Counter/Armorer's Mat

Also can be used as a (big) mouse pad. 5mm Neoprene backing with static free polymer face. Full Color Olympic Arms logo. 10"x13" in size.

T-SHIRTS

OA5. T-Shirts

Quality, all white, 100% cotton heavy weight, with Full Color Olympic Arms logo on the chest. Check for sizes on hand. **\$15⁰⁰**



3 Styles available:
Standard: Text reads, "Meeting the Demands of the 21st Century".
Stocking Dealer: Only available to licensed FFL Dealers (see left).
Dealer Distributor: Text reads "Dealer Distributor". Only available for Oly Dealer Distributors.

\$3⁰⁰

AR-15/PCR PARTS

F1. BARREL ASSEMBLY UNIT

This complete barrel assembly is just what you need for your tired out AR, or one that just needs a configuration change. All the parts necessary to do a complete rebarrel job from the receiver forward. Available in pre or post ban configuration, and a variety of lengths, contours and configurations. Button rifled barrels only.

For more information about Olympic Arms barrels please visit <http://www.olyarms.com/bblinfo.html>



Also available in pre-ban configurations:

with either a threaded muzzle and bayonet lug, or CAR bbl (11.5" bbl with permanently attached 5.5" flash hider) shown to the right.

Assemblies include:

1. New barrel with 1x9 twist
2. Front sight with base, complete with front sight post, detent and spring. Mounted with taper pins.
3. New barrel nut, hard plastic handguards, gas tube, gas tube roll pin, delta ring assembly, handguard cap, front sling swivel and pin,
Heat Shields Optional on 16" kit (ADD \$5⁰⁰).

F1A.	16" 4140 steel bbl	\$179⁰⁰
F1B.	16" SS bbl	\$221⁰⁰
F1C.	CAR bbl 4140 steel	\$239⁰⁰
F1D.	CAR bbl 416 SS	\$281⁰⁰
F1E.	20" 4140 steel barrel	\$197⁰⁰
F1F.	20" 416 SS	\$239⁰⁰
F1G.	FAR-15 lightweight	\$234⁰⁰
F1H.	16" M4 contour SS	\$234⁰⁰
F1HB.	16" M4 w/M4S Handguards	\$342⁰⁰
F1J.	Eliminator bbl	\$239⁰⁰
F1K.	Eliminator bbl SS	\$281⁰⁰

**PRE-BAN BARREL ASSEMBLIES ALSO AVAILABLE
PLEASE SPECIFY WHEN ORDERING**

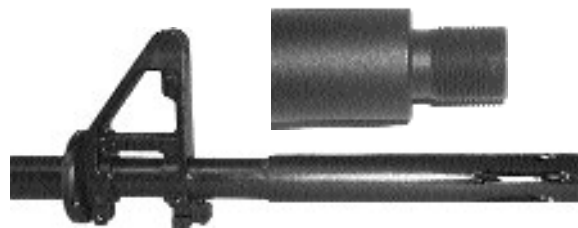

The famous K23B "Stubby" barrel assembly.



F1-23 6.5" heavy bbl **\$215⁰⁰**
w/stubby aluminum handguard and pig-tail gas tube.

F1-23 for use on legally registered pre-ban AR15 style pistols, and BATF registered shot barreled rifles only.

Note: You must specify pre-ban or post-ban at the time of the order. If no specification is made, we will ship all orders as post ban by default, at the purchasers expense.

PCR RIFLE AND CARBINE KITS



Complete Carbine Kits

Prices Starting at:

\$449⁰⁰ pt#PCR-CK

Complete Rifle Kits

Prices Starting at:

\$479⁰⁰ pt#PCR-RK

DEALERS! A Dealer FET Collection Indemnification Form must be on file with Olympic Arms before you are eligible to purchase AR/PCR kits. This form is required by Olympic Arms in order that all dealers fully understand the laws regarding the collection of Federal Excise Tax when rifle kits are sold or assembled. To receive your form, please ask your sales rep, or it can be downloaded from our web site at: <http://www.olyarms.com/kitform.html>.

PCR Kits Include: Fully assembled head-spaced and test fired A2 or flat-top upper receiver unit, bolt carrier assembly, charging handle, buttstock assembly, pistol grip assembly, and an all new complete lower receiver parts set (hammer, trigger, selector, springs, detents etc.). This kit includes 100% of all parts needed to finish a stripped lower receiver into the complete PCR/AR rifle or carbine of your customers choosing.

CARBINE KIT UPGRADE PACKAGES: ADD

M4P: M4 Carbine package. Includes M4 barrel, picatinny flattop upper, detachable carry handle and M4 style handguards **\$159.00**

M4TP: M4 Tactical Package. Includes M4 barrel, picatinny flattop upper, detachable carry handle F8R FIRSH rail handguard, VPG vertical pistol grip, and 12 panel covers (your choice from stock) **\$310.00**

VCP: Varmint Carbine package. Includes 16" Bull barrel (black 4140 1x9), picatinny gas block, picatinny flattop, F8 aluminum free floating handguard, and Ergo® brand pistol grip **\$108.00**

INDIVIDUAL OPTIONS:	ADD
16" M4 contour barrel (stainless steel)	\$50.00
Eliminator barrel (see page 10)	\$50.00
FAR-15 barrel (Featherweight barrel)	\$33.00
416 Stainless Steel barrel	\$25.00
CAR-97 stock (fixed collapsable)	\$30.00
Satin SS finish in SS barrel	\$10.00
F8 Aluminum Free float handguard	\$35.00
F8R FIRSH Rail Handguard	\$65.00
F8RLC (Long Carbine FIRSH handguard)	\$125.00
F7 Free float handguard for 20" barrels	\$42.00
F7R FIRSH Rail Handguard	\$129.00
A3 Picatinny Flattop upper	N/C
Detachable Carry Handle for A3	\$79.00
Muzzle Brake	\$25.00
AC4 Pneumatic Recoil Buffer	\$79.00

RIFLE KIT UPGRADE PACKAGES: ADD

VRP. Varmint Rifle Package. Includes 20" SS Bull barrel, F7A aluminum free float handguard assembly, picatinny gas block, Ergo® brand pistol grip, picatinny flat top upper receiver unit. **\$134.00**

UVRP. Ultra-Varmint Rifle Package. Includes 20" SS Bull barrel, F7A aluminum free float handguard assembly, bi-pod stud, picatinny gas block, picatinny flat top upper receiver, SR1 custom scope rings, Harris Bi-pod, and Ergo® brand Tactical pistol grip. **\$339.00**

TCSP. Tactical Counter Sniper Package. Includes 20" SS bull barrel, picatinny gas block, picatinny flat top upper receiver, F7R FIRSH rail handguard, SR1 custom scope rings, BPM bi-pod mount, Harris S-Series bi-pod, 2-Stage trigger assembly, and Ergo® brand Tactical pistol grip. **\$598.00**

Individual Options Continued:

Picatinny gas block (w/standard handguards)	\$62.00
Picatinny gas block (w/Free float handguards)	\$42.00
Bull Barrel (requires picatinny gas block and free float handguard)	\$60.00

WARNING: Olympic Arms cannot be held responsible for the fit, feed and or function of firearm(s) not fully assembled at the factory. As with any mechanical device, some fitting may be required. If you are not an experienced gunsmith, do not attempt the assembly of any firearm without professional assistance. If you require technical assistance in assembling your PCR/AR kit, please feel free to call us at 800-228-3471. We will be happy to help.

PCR/AR-15 BUTTONED BARRELS

ARB. AR-15 HEAVY MATCH BARREL (pre-or post ban available)

These are new production AR-15 barrels made from 4140 chromemoly steel. They are precision button rifled with 6 lands and grooves, and standard with a 1x9 twist. They come complete with new barrel nut, complete front sight base assembly, handguard cap and are standard with a HMG profile*.

*Bull barrels are delivered stripped, and do not come with a front sight base, barrel nut, handguard cap or gas block.

For more information about Olympic Arms barrels please visit <http://www.olyarms.com/bblinfo.html>

TO ORDER:

Specify length (16", 20", 24")

Caliber (5.56 NATO 1x9 twist standard)

(6mm = 1x10 standard)

(300 Fireball = 1x8 standard)

+F Fluted

+SS Stainless steel

Please indicate Pre- or Post-Ban at the time of the order.

Post-ban rifles cannot legally be fitted with threaded barrels.

1x7, 1x12, 1x14 twist subject to availability on 5.56 NATO chamberings only. Alternate twist/special order only. Add \$45.00 to the cost of the barrel.

All barrels will be shipped as post ban 4140 chromemoly barrels unless otherwise specified at the time of order.

Barrel Pricing:

ARB-FAR	16" Lightweight barrel	\$187⁰⁰
ARB16	16" AR Barrel	\$145⁰⁰
ARBCAR	16" Pre-Ban CAR barrel	\$162⁰⁰
ARBM4	16" M4 Contour AR Barrel (SS Only)	\$187⁰⁰
ARBELM	16" Eliminator AR Barrel (SS Only)	\$187⁰⁰
ARB20	20" AR Barrel	\$163⁰⁰
ARB24	24" AR Barrel	\$211⁰⁰

Options:

Pre	Pre ban style (threaded w/bayo lug.)	N/C
SS	Stainless Steel	Add \$42⁰⁰
Bull	Bull Barrel Dia.	N/C
Alt.	Alternate Twist (1x7, 1x8, 1x12)	Add \$54⁰⁰

Alternate Calibers Available:

6PPC, .17 Rem, 6x45, 7.62x39 & .300 Fireball Add **\$54⁰⁰**
 (Alternate caliber barrels are not available in all configurations)

Custom Shop Options and Charges

Any barrel ordered with custom shop options, or made to customer-supplied specifications is subject to the Custom Shop charge, plus additional option fees.

CUSTOM SHOP FEE	\$60⁰⁰
FLUTING	\$90⁰⁰
CUSTOM LENGTH, CONTOUR OR THREAD	\$42⁰⁰

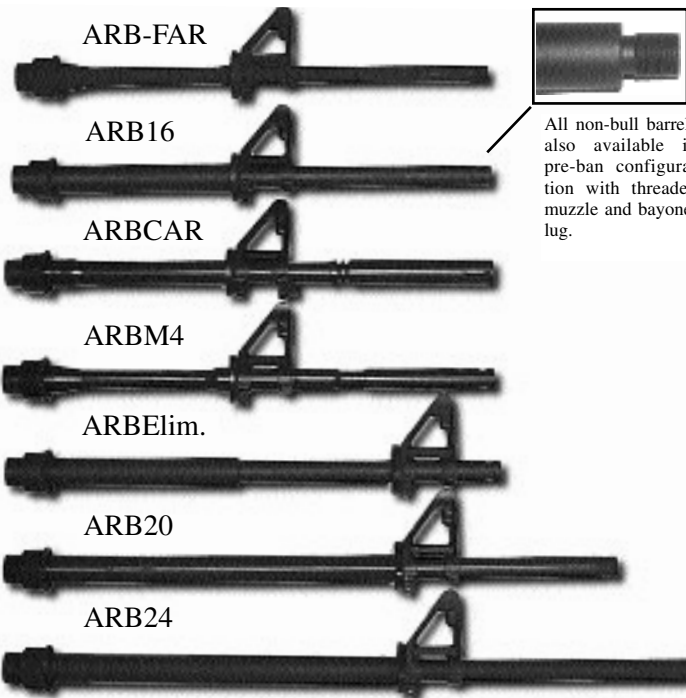

All non-bull barrels also available in pre-ban configuration with threaded muzzle and bayonet lug.

ARB16Bull

ARB20Bull

ARB24Bull



ARB20 Fluted



ARB24Bull Fluted

(Shown with satin bead-blast finish.)



SUM20 Fluted

Fluted AR Barrels are available in both the button rifled and broach cut (Ultramatch/SUM) styles.

All barrels are fluted with six 1/4" wide grooves. This end-mill cut method increases surface area by 105%, which increases cooling during rapid fire and adds barrel rigidity. Barrel weight is reduced approximately 12 to 14 ounces (on 20" barrels) and rigidity increases 20 to 25%.

Standard Match barrels are fluted full length (in front and behind the front sight), while SUM (Ultramatch) barrels are fluted behind the front sight base only.

Please allow a minimum of 90 days for delivery on all fluted barrels if not in stock at the time of order.

PCR/AR-15 ULTRAMATCH BARRELS

THE MOST ACCURATE AR BARRELS AVAILABLE!

SUM (STAINLESS ULTRA MATCH) BARRELS

All SUM barrels are broach-cut from 416R stainless steel bar stock to the GI specified National Match 4 lands and 4 grooves bore. Each blank is double heat stress relieved and air-gauged for consistency. These are the **BEST** AR barrels money can buy. *Unless otherwise specified, all SUM barrels will be delivered as a post-ban (non-threaded) barrel, in a 1x10 twist with a black oxide coating.*

For more information about Olympic Arms barrels please visit <http://www.olyarms.com/bblinfo.html>

TO ORDER:

Specify length (16", 20", 24", 26")

Specify twist (1x10 or 1x8)

+F Fluted

Please indicate Pre or Post ban at the time of the order

SUM OPTIONS:

1x8 1x8" twist

Pre Threaded muzzle w/bayo lug N/C

+F Fluting See Custom Shop Options

16" - \$229⁰⁰

20" - \$239⁰⁰

24" - \$272⁰⁰

26" - \$308⁰⁰

Also available in Pre-Ban configuration with Threaded Muzzle and Bayonet Mount.

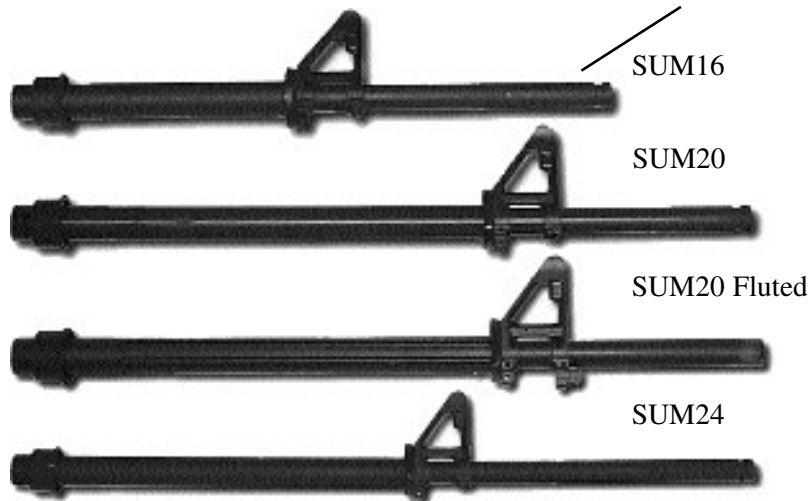

Ultramatch® Bull Barrels



"I have purchased over 500 Ultramatch barrels over the years...I've only ever received 2 bad ones. When you buy another manufacturers non-broach cut barrel, you may get a screamer, or a lemon, or one just good enough that you can't send it back, but yet will never satisfy a quality shooter. It's a crap shoot. With an SUM barrel, there are no variables. One of the two barrels I've sent back had a very bad galling mark on a groove, it was what I'd call a bad barrel, yet it still grouped ragged holes! I guess what I'm saying is that with the manufacturing consistency and tolerances of a Oly SUM barrel, that the potential to be a one-hole barrel is built in to every barrel! I guaranty sub MOA with all of my custom AR's, and Oly is the only company I can trust to provide that every time. Truthfully, I expect 1/4 moa or better, and if an SUM barrel won't do that, it's a bad one. My point is this; if my history is proof, you have a 99.996% chance of the SUM barrel you buy of being a screamer! That's just plain hard to beat."

Mike Milli: Proprietor
Dedicated Technology
Bemidji, MN
10 year + Oly Arms customer
Top 10 Dealer Distributor

Picatinny Rail Gas Blocks



These gas blocks are machined from solid aluminum extrusions. They are available for both standard contour heavy barrels (.728") and standard Bull barrels (.928"). Cut with standard picatinny rails, they will accept all picatinny standard hardware including detachable A-Frame style front sight bases and globe sights.

GB. \$42.00 ea. *Please specify diameter when ordering.*

MAXHARD

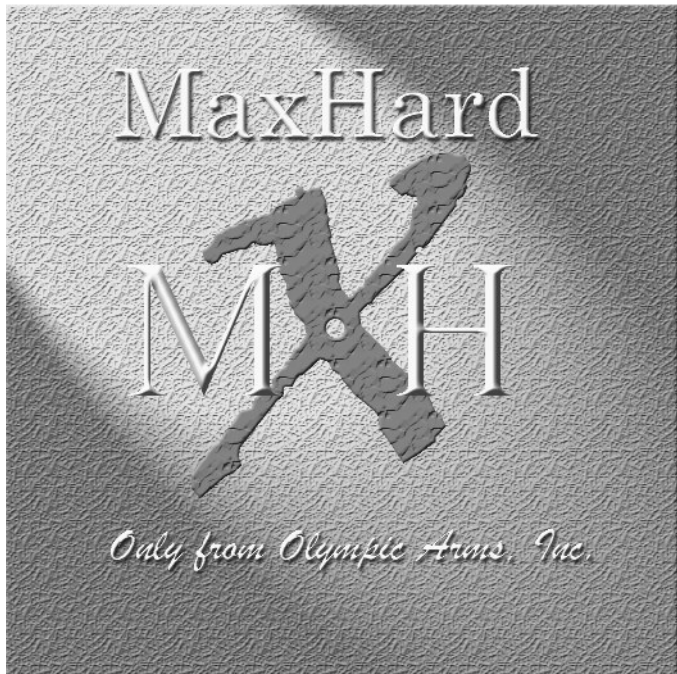

When MaxHard was re-introduced to the public 3 years ago, it was immediately faced with consumer scrutiny. The basic questions were this; Is this just the latest fad in the AR-15 style rifle market? Was this just a marketing gimmick? Does MaxHard have a real benefit? And perhaps most importantly, What is Maxhard? All good questions which we will answer here, but my first point is this; Maxhard is not new! When we started to once again offer Maxhard to the public in 2000, Olympic Arms already had 10 years or more experience with the process. It has been used, and it has been proven.

So, this begs the question, If this is true, and MaxHard was first released over 10 years ago, why was it stopped if it was so good? Great question. The answer is, it never was stopped. The MaxHard process, to be explained below, was being used in dozens of other applications, and was also being tested by many government and military agencies because of its excellent qualities. It is only now that we fully understand its amazing benefits, and are able to finally pass all of those benefits on to you.

WHAT IS MAXHARD? Maxhard is a proprietary chemical heat bath process that is used to harden a particular metal, in this case, 4140 carbon steel, 416 stainless steel, and 7076 T6 aluminum. The MaxHard hardening process *dramatically increases the tensile strength and Rockwell hardness of a material*. It is a surface treatment that is *virtually impervious to corrosion* (even under the most severe conditions), and *tremendously increases the materials ability to dissipate heat*. The MaxHarding process allows for complete control over the depth of hardness and degree of hardness allowing for variances based on the material base and the application of product. The process was first developed in the late 80's and was used with much success. Now, with the process even further perfected, the benefits are almost too great to imagine.

EFFECTS ON ALUMINUM

A normal aluminum receiver may not even produce a Rockwell (hardness) reading. If it does, it would register 1 or 2 on the "Rc" scale. Once an aluminum receiver has been through the Maxhard process it becomes up to 20 times harder, producing an Rc reading of up to 20 a score equivalent to that of mild steel!

Maxhard treatment will give you a smoother, black surface finish that will be harder and more scratch resistant than a standard hard anodized finish. MaxHard receivers will be more corrosion resistant, will be more lubrous than, and reduce friction better than any other aluminum receiver made by anyone.

Expensive trigger jobs will last because the hammer/trigger pin holes will not wear. Tight fitting receivers will stay tight because the take down pin holes will not wear. What you get is a receiver with *the strength of mild steel*, yet the light weight of aluminum.

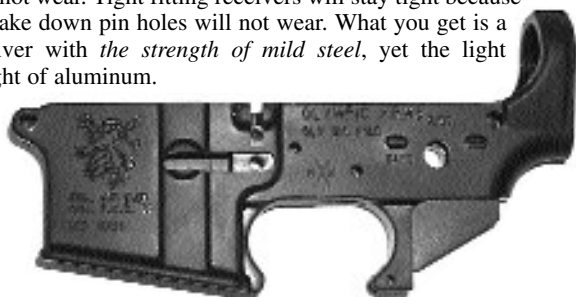

EFFECTS ON STEEL

Maxhard effects on steel have been nothing short of radical. Tests on MaxHard products conducted by the military have found that a MaxHard treated bolt ran for over 9,000 rounds of sustained full auto fire without a failure, whereas the standard bolt of the M16M4 was lucky to last 1,000 rounds fired. Additionally, barrels treated with the MaxHard process showed a fantastic ability to dissipate heat, virtually eliminating the possibility of a cook off.

When tested, our chromemoly steel barrels delivered a Rockwell score of 28-30 Rc. After having been treated to th MaxHard process, the barrels then registered at an amazing 58 Rc almost doubling their hardness without becoming brittle! The Rc on the stainless steel barrels tested were raised to 62 Rc!

With Military testing still on-going, and all of our production headed in that direction, we are not offering MaxHard barrels to the general public as of yet. We are concentrating now on the availability of aluminum receivers.



NOTE: The Maxhard process is only available on factory new products. Maxhard is not available for the treatment of customer supplied materials and products.

BLAK-TAC

Blak-Tac

THE FUTURE OF FIREARMS METAL TREATMENTS

Armour

Owning an Olympic Arms Blak-Tac treated product ranks you among the most discriminating firearms connoisseur in the world. The Blak-Tac process enhances metal in many ways, and creates one of the strongest, longest lasting, most corrosion resistant finishes on the planet. Blak-Tac, only available from Olympic Arms, is a chemical heat bath process that changes the surface of the metal being treated by adding strength (increasing the materials Rockwell hardness), and changing the molecular structure of the surface of the metal to produce a smooth, lubrous surface that is virtually impervious to corrosion.

couche 880 HV 0,025 à 25 microns sous la couche 500 HV 0,1

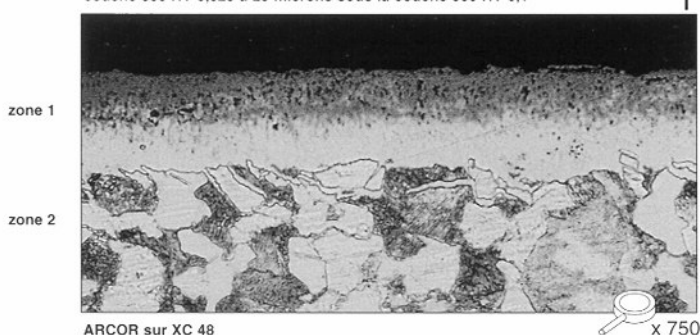

Shown at a magnification level of 750X, the photo to the left reveals the results of Blak-Tac metal treatment to steel bar stock. Creating 2 zones in the metal, the surface becomes more dense, harder, smoother, and and virtually impossible to chip, crack, or flake or break. Being much more smooth than before treatment, the likelihood of galling in any metals is practically eliminated, and friction is reduced dramatically.

Blak-Tac is a treatment that combines thermochemical diffusion in hot chemical baths, with a finishing treatment (a passive impregnation of an organic sealant) to produce a surface having exceptional resistance to wear, scuffing, galling, corrosion and fatigue.

Blak-Tac is a duplex process that heat-treats the metal while at the same time treating its surface. This replaces what is normally a two-step process with a one-step process that is much more efficient and effective. Blak-Tac also eliminates any risk of failure due to Hydrogen embrittlement, a major problem with many other applied metal coatings.

Blak-Tac creates no dimensional difference, and is totally controllable with regards to depth of treatment and hardness. Dependent on the material being treated, Blak-Tac can penetrate from as little as 10, to as much as 25 microns, and with some materials, much deeper yet.

Blak-Tac will be used by Olympic as a complete replacement for hard chrome finish. Notice the bore of the bolt carrier to the left. After 7 days in a 30% salt solution and 170 hours of natural exposure to the elements, the center bolt carrier (a new parkerized carrier with a chrome bore) is rusted inside and out! The bolt carrier to the left, and SS 1911 barrel to the right (both treated to the Blak-Tac process) are completely rust free.

Places where galling, scuffing, wear, seizure or corrosion are encountered, Blak-Tac is an ideal metal treatment. You can consider Blak-Tac a complete replacement for popular metal coatings such as hard-chrome, nickel, cadmium, zinc, Teflon and more.

Blak-Tac treated bolt carriers are currently being used as standard equipment in all Olympic Arms AR15 and M16 products. No more chrome lined bolt carriers to chip and crack. No more broken gas rings due to failing chrome linings in your bolt carrier. Blak-Tac is also available in our 1911 series as the Blak-Tac Matchmaster. Blak-Tac; the future of firearms metal treatments.



(What little discoloration that is seen on the Blak-Tac treated barrel and bolt carrier is nothing more than residue that has chemically electrolyzed from the untreated carrier onto the other parts in the same bath. These deposits wiped right off with out fingers!)

OLYMPIC ARMS' & SCHUETZEN PISTOL WORKS 1911 SERIES PISTOLS



In 1987 Olympic Arms incorporated Safari Arms, and began production of 1911 handguns in the form of the now famous Matchmaster and Enforcer pistols. Because of technological and quality advancements made along the way, the current production models bear only a superficial resemblance to the original handguns produced prior to those now manufactured in Olympia, Washington.

This year, in 2004, the management at Olympic Arms has made another decision in the evolution of their 1911 handgun production. From this point on, the Safari Arms name will no longer be used in order that all of the 1911 handguns now produced will carry the more familiar Olympic Arms name and logo.

In 1993 the 'Schuetzen Pistol Works' was created to differentiate between the standard production 1911 handguns being produced here in house, and the new, custom built offerings now being made available.

You will find that some 1911 pistols will carry the SPW markings, and some will not, but all will be labeled as Olympic Arms pistols. Regardless of the name or logo on your pistol, rest assured that all the 1911's that leave the factory with the SPW custom shop logo, and the standard production Olympic Arms brand are both the highest quality 1911's you may find anywhere in their price range.

All custom order 1911's will be marked with the SPW markings. Olympic Arms 1911 production is overseen by Richard Niemer of Detonics fame. He and Assistant Pistolsmith, Mike Hadley, are 2 of the most experienced and skilled pistolsmiths in the country.

In addition to the standard Olympic Arms offerings, the Street Deuce and Journeyman Premium Grade pistols from the SPW shop are top-notch, high-end pistols that are as good or better than any other 1911 at any price! But what makes the SPW product so special is that you can have your custom 1911 handgun made just for you. Simply talk to Richard in the pistol shop, and he'll take your order.

We are often asked if we provide an accuracy guaranty with our handguns. Well, the answer is essentially, no; we do better than that. Not only do all of our 1911's come with a limited lifetime warranty, we offer a 60 day 100% Satisfaction Guarantee. What this means is that within 60 days of the date of purchase, if you are not 100% satisfied with your Safari Arms/SPW purchase, you can have your dealer return the handgun to us for a full refund.

Our promise to you is simple. We are confident that we build the best in 1911 45 caliber handguns, and we are willing to stand behind that with the best product warranty in the business. Plain and simple, we are taking over!

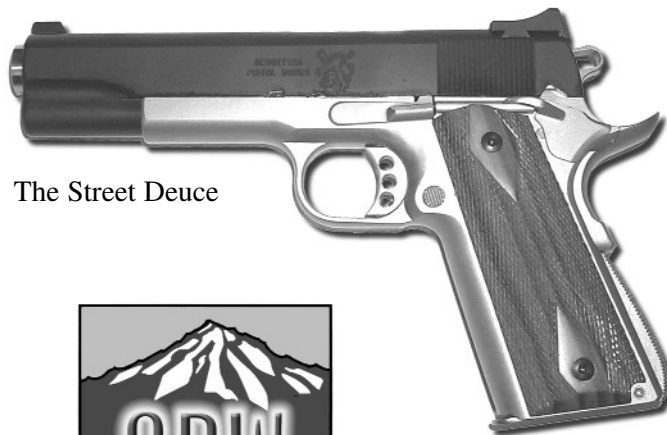

The Street Deuce



The new Schuetzen Pistol Works logo, introduced in November 2003.

THE MATCHMASTER

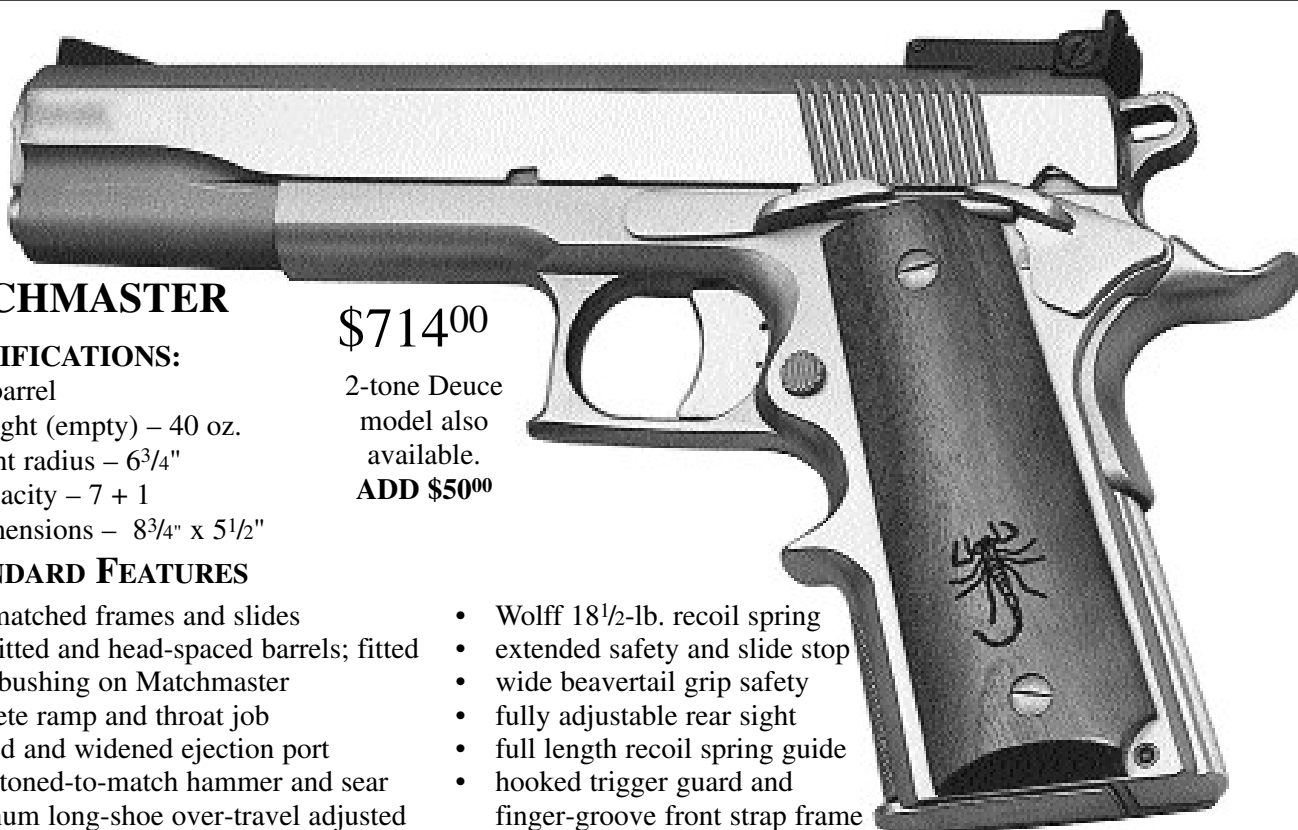

MATCHMASTER

SPECIFICATIONS:

- 5" barrel
- Weight (empty) – 40 oz.
- Sight radius – 6³/₄"
- Capacity – 7 + 1
- Dimensions – 8³/₄" x 5¹/₂"

STANDARD FEATURES

- hand-matched frames and slides
- hand-fitted and head-spaced barrels; fitted barrel bushing on Matchmaster
- complete ramp and throat job
- lowered and widened ejection port
- hand-stoned-to-match hammer and sear
- aluminum long-shoe over-travel adjusted trigger
- trigger pull set 5 to 6 pounds
- shaped and tensioned extractor

\$714⁰⁰

2-tone Deuce model also available.
ADD \$50⁰⁰

- Wolff 18¹/₂-lb. recoil spring
- extended safety and slide stop
- wide beavertail grip safety
- fully adjustable rear sight
- full length recoil spring guide
- hooked trigger guard and finger-groove front strap frame
- smooth, laser etched walnut grips
- full function test-fired with ball, LSWC and JHP
- choice of stainless, black parkerized carbon steel, or deuce configuration

← **6" Barreled Long Slide!!** →

SAFARI ARMS MATCHMASTER™ 6"

SPECIFICATIONS:

- 6" barrel
- Capacity – 7 + 1
- Dimensions – 9³/₄" x 5¹/₂"
- Weight (empty) 44 oz.
- Sight radius – 7³/₄"
- *Same Features as 5" Matchmaster above, less full length recoil spring guide.*

\$774⁰⁰

Also Available with standard GI Frame



BIG DEUCE
\$834⁰⁰

THE ENFORCER & COHORT

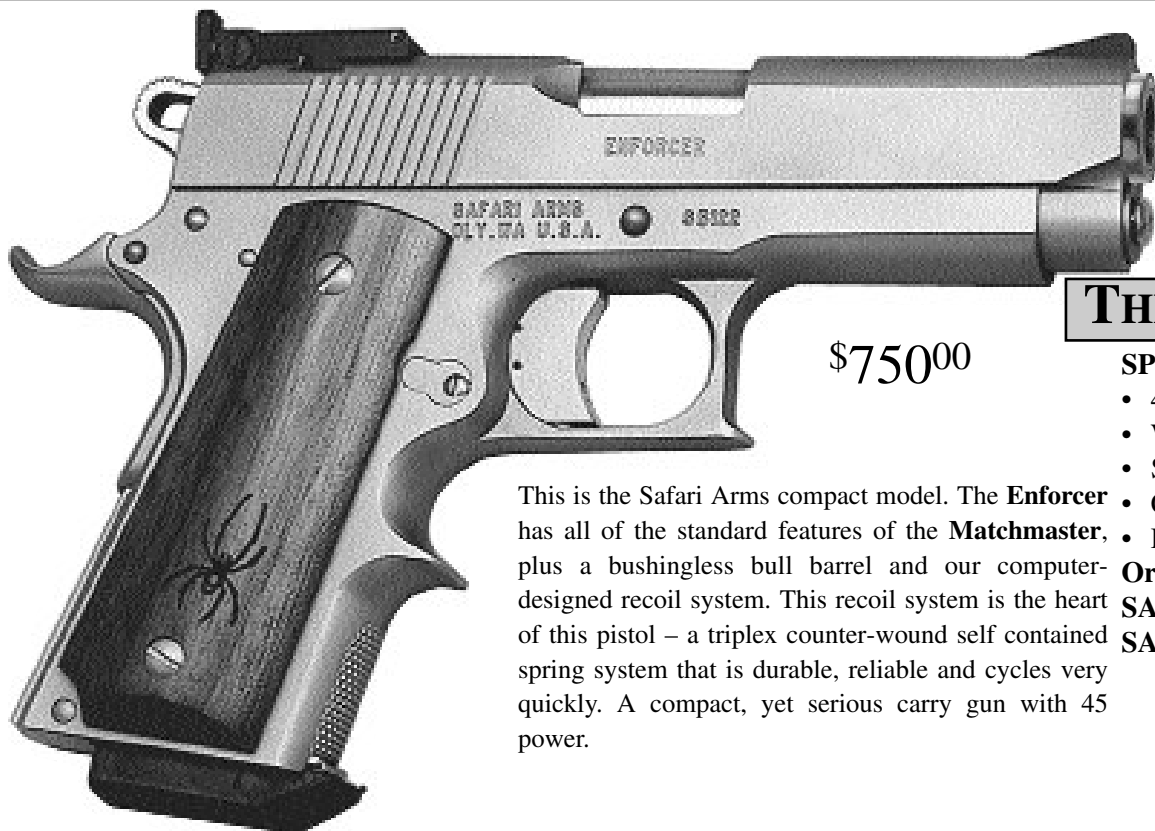

\$750⁰⁰

THE ENFORCER

SPECIFICATIONS:

- 4" bull barrel
- Weight (empty) – 36 oz.
- Sight radius – 5 3/4"
- Capacity – 6 + 1
- Dimensions – 7 3/4" x 5"

Order No:

- SAE-1 A. Stainless Steel**
- SAE-1 B. Steel**

This is the Safari Arms compact model. The **Enforcer** has all of the standard features of the **Matchmaster**, plus a bushingless bull barrel and our computer-designed recoil system. This recoil system is the heart of this pistol – a triplex counter-wound self contained spring system that is durable, reliable and cycles very quickly. A compact, yet serious carry gun with 45 power.



EFRS. The heart of the Safari Arms 4" pistols. This captured recoil spring assembly was CAD designed to allow for maximum performance. The EFRS system must be fitted to your handgun if used as a replacement or upgrade part. **\$7200**



THE COHORT

SPECIFICATIONS:

- 4" bull barrel
- Weight (empty) – 38 oz.
- Sight radius – 5 3/4"
- Capacity – 7 + 1
- Dimensions – 7 3/4" x 5 1/2"

\$779⁰⁰

The **Cohort** combines the short **Enforcer** top end and recoil system with a full-size **Matchmaster** frame. Standard with the rounded trigger guard, it is sure to fit into any of the quality holsters for mid-length pistols. All the same standard features as all the Safari model 1911's.

THE WESTERNER SERIES



\$834⁰⁰



*TRUE case color
hardened 1911
handguns. Each
one a collectable
work of art.*

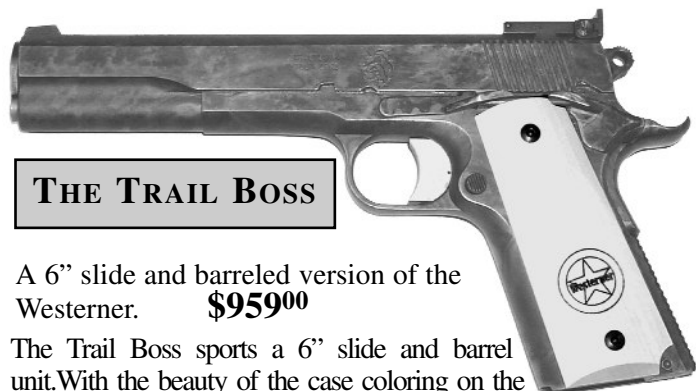

THE TRAIL BOSS

A 6" slide and barreled version of the Westerner. **\$959⁰⁰**

The Trail Boss sports a 6" slide and barrel unit. With the beauty of the case coloring on the extra length of slide assembly, the Trail Boss really takes your breath away. Standard with laser engraved stocks.

Building from the great success of the Westerner pistol introduced in 2003, Olympic Arms has decided to expand its line of true case color hardened 1911 offerings by two new models. Truly, the awe inspiring colors of these unique case color hardened handguns is lost in black and white print. The pistols, case colored the old fashioned way, are vibrantly brilliant with beautiful shades of blue, violet, crimson and patina. These are definitely not your Daddy's old 45's. *These are truly heirloom quality all the way.*

The beauty of these 1911's is honestly so inspiring that you will be tempted to put it in your safe never to be shot. But the fact remains that each one of these pistols is very carefully hand assembled and is fully functional handgun of excellent quality. Extremely reliable and capable of supreme feats of accuracy, the results of the case color hardening will give you a handgun that will virtually never wear! Each one hand fitted, then case colored and re-assembled, *these handguns are uncompromising works of art.*

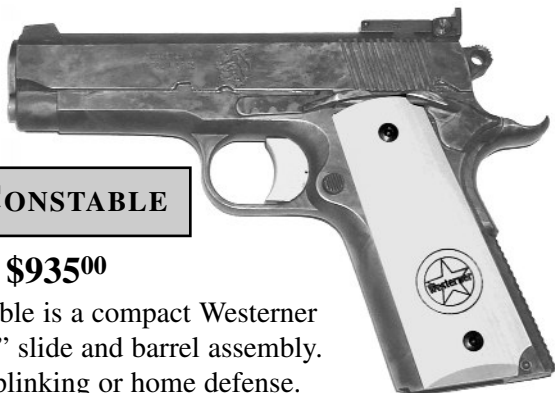

THE CONSTABLE

\$935⁰⁰

The Constable is a compact Westerner with a 4.25" slide and barrel assembly. Fitting for plinking or home defense. Standard with a laser engraved badge on each set of stocks.

"My Trail Boss is absolutely beautiful, and shoots as well as it looks. It is unbelievably accurate and a real joy to shoot."

Kris Kindschuh
Proprietor: Bullseye Shooters Supply, LLC
Tacoma, WA
Olympic Arms Dealer Distributor



Schuetzen Pistol Works

Street Deuce & Journeyman

Technical Data



Photo credit: Mr. Dave Workman

Standard Features:

- Stainless Steel Frame
- Carbon Steel Match-Hard Slide
- Lowered and Widened Ejection Port
- Hand Shaped and Tensioned Extractor
- Polished Ramp and Throat
- Stainless Steel NM Bushingless Bull Barrel (individually chambered and hand matched to the slide & frame)
- SPW Hi-Ride Beavertail with PDR (Positive Disengagement Ridge)
- Beveled Magazine Well
- Hand Matched Sear and Commander Hammer
- Custom Trigger Adjusted for Over-Travel
- Raised Front Strap
- Extended Thumb Safety
- Double Diamond Checkered Rosewood Grips
- Triplex Counter Wound Recoil Spring (Journeyman Only)

Choices:

Some standard feature choices are available to you at no additional cost. These can be mixed and matched as you desire.

- Flat or Arched Mainspring Housing (checkered 20LPI)
- LPA Adjustable rear site, or Heinie Slant Pro fixed rear sight

OPTIONS:

Options are available on either the Street Deuce or Journeyman models.

- Heinie Straight 8™ Tritium Sights (front and rear) \$125⁰⁰
- Heinie Tritium Front Sight Only \$65⁰⁰
- Serrate Rear of Slide to Match Sight \$40⁰⁰
- Custom Serial Number \$50⁰⁰
- Extended Mag Catch \$20⁰⁰
- Ambi Safety \$75⁰⁰
- Friction Tape Front Strap \$20⁰⁰
- Fast Action Safety \$200⁰⁰



Schuetzen Pistol Works The Specialty Shop



STREET DEUCE

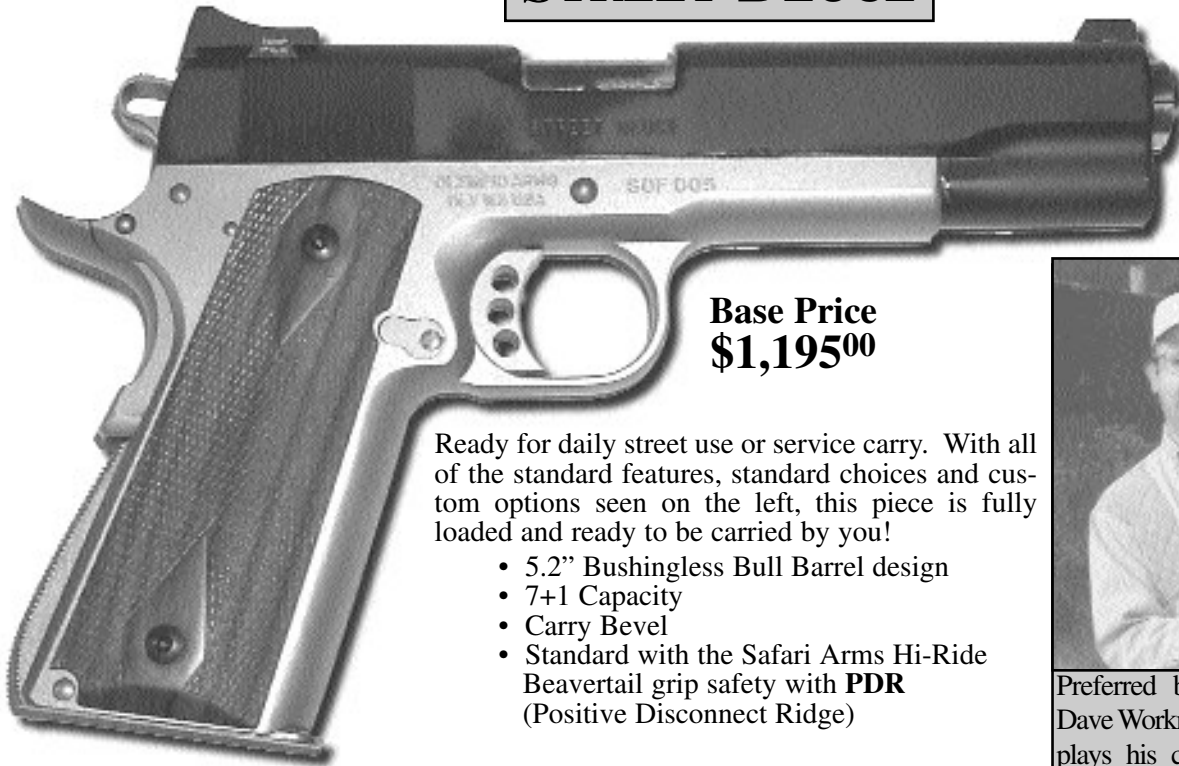

**Base Price
\$1,195⁰⁰**

Ready for daily street use or service carry. With all of the standard features, standard choices and custom options seen on the left, this piece is fully loaded and ready to be carried by you!

- 5.2" Bushingless Bull Barrel design
- 7+1 Capacity
- Carry Bevel
- Standard with the Safari Arms Hi-Ride Beavertail grip safety with **PDR** (Positive Disconnect Ridge)

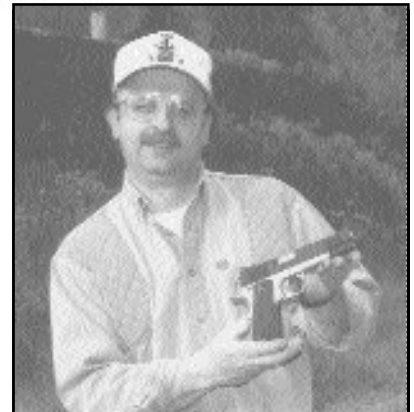

Preferred by popular gun author Dave Workman, here he proudly displays his custom made Schuetzen Pistol Works Street Deuce.

JOURNEYMAN

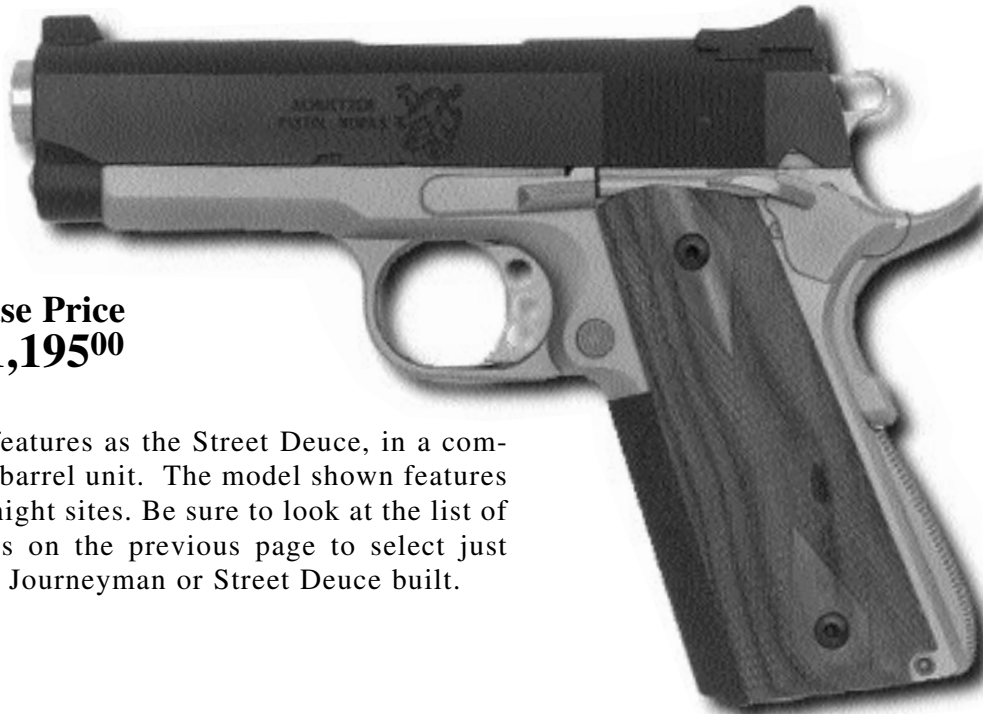

**Base Price
\$1,195⁰⁰**

Same outstanding features as the Street Deuce, in a compact 4.2" slide and barrel unit. The model shown features the Heinie® fixed night sites. Be sure to look at the list of options and choices on the previous page to select just how you want your Journeyman or Street Deuce built.



Schuetzen Pistol Works The Specialty Shop



BLAK-TAC



\$875⁰⁰



Read more about the Blak-Tac Armour treatment on page 55

Blak-Tac gives you:

- *No Slide wear!*
- *No Frame wear!*
- *No fear of galling!*
- *Unmatched corrosion resistance!*
- *Self lubricating action!*
- *Tough as nails attractive matte black finish!*

The Olympic Arms Blak-Tac process has been being used on all of the bolt carriers produced by Olympic Arms for the past year and more. The Blak-Tac Matchmaster was introduced in 2003, but but has been seriously upgraded for 2004 in appearance and configuration in order to fit the Tactical implications of its name.

The frames and slides of each Blak-Tac Matchmaster are hand-fitted and the pistols are fully assembled, then and only then do we proceed with the Blak-Tac processing. Why? Because once we have treated the frames and slides to the Blak-Tac process, they become so hard, that fitting is no longer an option!

The Blak-Tac Matchmaster is an awesome piece of mechanical functional reliability with unmatched longevity, mixed with a beautiful appearance. Designed around the standard Matchmaster by Olympic Arms, this pistol begins with all the same features such as a 416 true National Match barrel made here by Olympic Arms. It is also standard with things like a widened and lowered ejection

port, complete ramp and throat job, tuned and tensioned extractors, 18.5 lb Wolff brand recoil spring, full length recoil spring guide and more. But it is then outfitted with the Blak-Tac standard package which includes:

- Blak-Tac treated frame and slide
- Round trigger guard with finger groove front strap
- High-ride Olympic Arms beavertail with PDR
- Low Profile combat style sights
- Front and rear slide serrations
- Your choice of arched or straight main spring housings
- Custom engraved slide emblazoned *Blak-Tac*
- Low Profile combat style sights
- Front and rear slide serrations
- Adjustable automatch trigger

This is a great deal of 1911 for the money. With features that would cost you literally hundreds of dollars more elsewhere, plus the Blak-Tac treated frame and slide only available from Olympic Arms! *All with the standard Olympic Arms Lifetime Warranty.*



OLYMPIC ARMS
SCHUETZEN PISTOL WORKS



MATCHMASTER 5" SLIDES

Round top, available in stainless steel or carbon steel.

SAS-1A. 5" SS Slide

SAS-1B. 5" Carbon steel slide
(in the white)

Your Choice: \$159⁰⁰



ENFORCER/COHORT 4" SLIDE

Available in stainless steel or carbon steel (front serrations not available).

SAS-2A. 4" SS Slide

SAS-2B. 4" Carbon steel slide
(in the white)

Your Choice: \$169⁰⁰

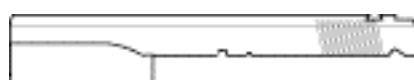

MATCHMASTER 6" SLIDES

Available in stainless steel or carbon steel.

SAS-6A. 6" SS Slide

SAS-6B. 6" Carbon steel slide.
(in the white)

Your Choice: \$179⁰⁰

Slide Options:

- LPA rear sight cut is standard on all slides.
- .320"x60 front sight dovetail cut standard on all slides.
- All other sight cuts are special order.
- Front serrations available on all 5" and 6" slides only.
- All slides are available with your custom sight cuts, or no sight cuts at all *as a Special Order*.
- All Special Orders are produced in the Specialty Shop.

**When ordering stripped frames or slides,
PLEASE
specify Stainless or Carbon Steel.**

SAFARI ARMS 1911 COMPLETE TOP ENDS

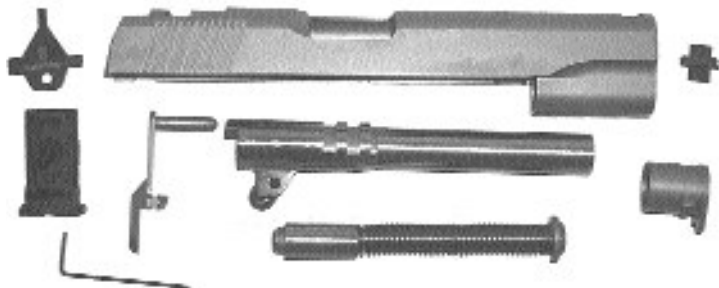

SA100. This unit is a complete, unassembled 1911 top end. Various lengths and configurations available. Comes with all parts for the slide assembly including:

Bushing, Slide Stop, CNC Machined Slide, 416 SS National Match Barrel, 1 pc Recoil Assembly, LPA Adjustable sight set, firing pin stop, firing pin, firing pin spring and extractor.

- SA100-5A.** 5" Slide Assembly; SS **\$359⁰⁰**
- SA100-5B.** 5" Slide Assembly; Carbon Steel **\$359⁰⁰**
- SA100-4A.** Enforcer Style Slide Assembly; SS **\$474⁰⁰**
- SA100-4B.** Enforcer Style Slide Assembly; Carbon Steel (in the white) **\$474⁰⁰**
- SA100-6A.** 6" Slide Assembly; SS **\$383⁰⁰**
- SA100-6B.** 6" Slide Assembly; (carbon steel in the white) **\$383⁰⁰**
- SA100-5DA.** 5" "D" Type Bull-Barrel Slide Assembly; SS **\$419⁰⁰**
- SA100-5DB.** 5" "D" Type Bull-Barrel Slide Assembly; Carbon Steel (white) **\$419⁰⁰**

Options:

+P Parkerized carbon steel slide assembly. **\$30⁰⁰**

NATIONAL MATCH BULL BARRELS ONLY

ENFORCER/COHORT/JOURNEYMAN 4.25" BARRELS
.45 ACP Only

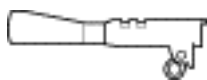

D-Type Barrels:
\$125⁰⁰
(fitting required)

STREET DEUCE 5" BARRELS
Modified cone/bull barrel
.45 ACP Only



1911 Slides available in: S = Stainless Steel or C = Carbon Steel

+KS = Insert Kit, slide. 5". All parts for 1911 top-end <i>less the slide itself</i>	\$179⁰⁰
+KSE = Insert Kit, slide, Enforcer 4". All parts for Enforcer top end <i>less the slide itself</i> .	\$238⁰⁰
+ P = Parkerized (Carbon Steel Only) Slide	\$30⁰⁰



OLYMPIC ARMS
SCHUETZEN PISTOL WORKS



STRIPPED MATCHMASTER FRAMES (1911 SERIES 70)

M1.
Hooked
trigger
guard & finger
groove front strap.

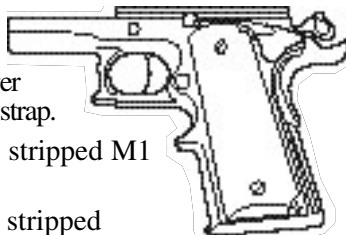

SAF-M1A. stripped M1
frame; SS.

SAF-M1B. stripped
M1 frame; carbon steel
(in the white).

M2.
Square
trigger
guard & finger
groove front strap.



SAF-M2A. stripped M2
frame; SS

SAF-M2B. stripped M2
frame; carbon steel (in
the white).

M3.
Round
trigger
guard & finger
groove front strap.

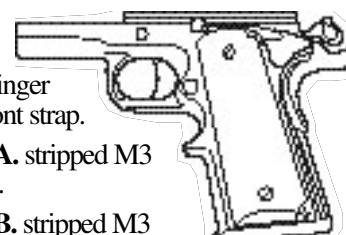

SAF-M3A. stripped M3
frame; SS.

SAF-M3B. stripped M3
frame; carbon steel (in the
white).

Your Choice Only \$139⁰⁰ Please Specify Stainless or Carbon Steel

CRF1.
Standard GI type frame with
round trigger guard & straight front strap.

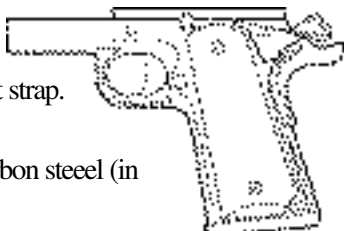

CRF1A. stripped CRF1 frame; SS

CRF1B. stripped CRF1 frame; carbon steel (in
the white)

CRF2.
Square trigger guard & straight
front strap.

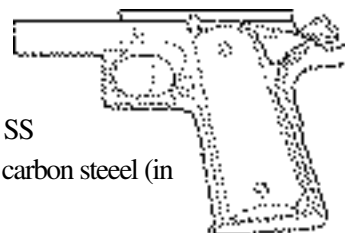

CRF2A. stripped CRF2 frame; SS

CRF2B. stripped CRF2 frame; carbon steel (in
the white)

All Matchmaster & CRF frames are standard 7-round mags.

STRIPPED ENFORCER FRAMES (1911 SERIES 70)

E1.
Hooked
trigger guard &
finger groove
front strap.

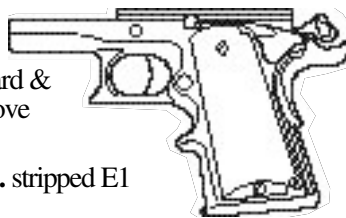

SAF-E1A. stripped E1
frame; SS.

SAF-E1B. stripped E1 frame; carbon steel
(in the white)

E2. Square
trigger guard
& finger groove
front strap.

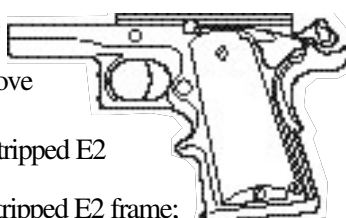

SAF-E2A. stripped E2
frame; SS.

SAF-E2B. stripped E2 frame;
carbon steel (in the white)

E3.
Round
trigger
guard & finger
groove front strap.

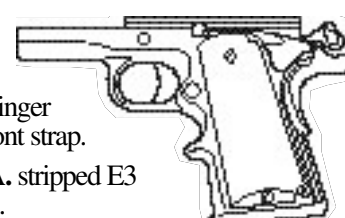

SAF-E3A. stripped E3
frame; SS.

SAF-E3B. stripped E3
frame; carbon steel (in the white)

Your Choice Only \$139⁰⁰ Please Specify Stainless or Carbon Steel

E4. Square trigger guard &
straight front strap.

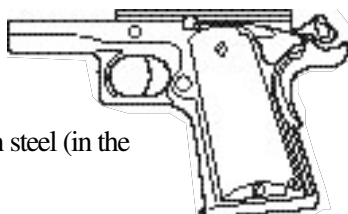

SAF-E4A. stripped E4 frame; SS.

SAF-E4B. stripped E4 frame; carbon steel (in the
white)

E5. Round trigger guard &
straight front strap.

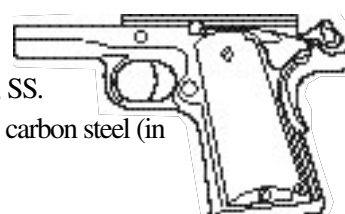

SAF-E5A. stripped E5 frame; SS.

SAF-E5B. stripped E5 frame; carbon steel (in
the white)

All Enforcer frames use 6-round Officer model mags.

1911 Frames available in: S = Stainless Steel or C = Carbon Steel

+KF = Insert Kit for frame. All parts for 1911 frame less the frame itself	\$179 ⁰⁰
+P = Parkerized	\$42 ⁰⁰
+L = Loaded Frame, includes the installation of the ejector, plunger tube, and grip screw escusions.	\$42 ⁰⁰



OLYMPIC ARMS
SCHUETZEN PISTOL WORKS

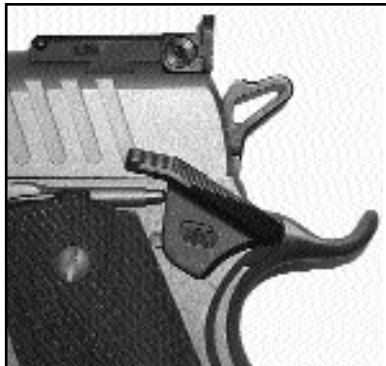

FAS FAST ACTION SAFETY

Belgian Manufactured Quality!

Now available on all of our Safari Arms, and Schuetzen Pistol Works Specialty Shop 1911s. The Fast Action Safety System is a hammer/safety fire control system that allows the pistol to carry a round in the chamber, with the hammer down, with all safeties engaged as shown at left. When ready to fire, simply disengage the thumb safety and the hammer snaps back to its full cock, ready to fire position. No more need to carry with the hammer back on a live round. Excellent for Law Enforcement and personal protection use alike.

FAS INSTALLED - \$200⁰⁰

FAS STAND ALONE - \$125⁰⁰

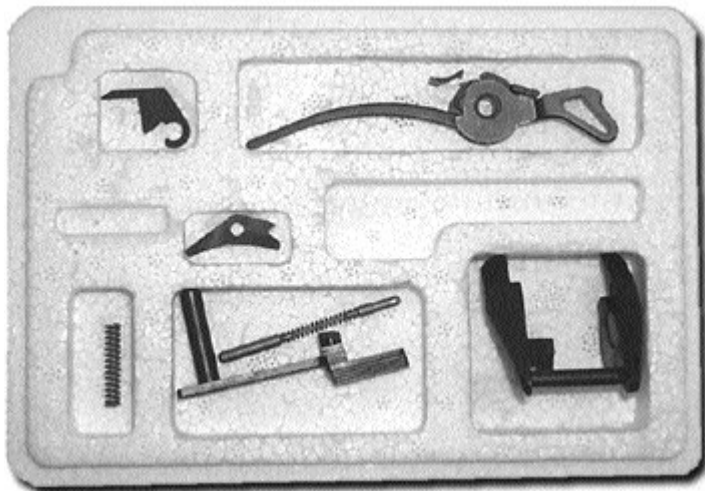

FAS.

The Fast Action Safety system is available as a stand alone package as shown at left. This system must be installed by an expert pistolsmith, and turns a standard single action 1911 into a “politically/socially-correct” handgun.

Kit comes complete with all replacement parts needed, including a new ambidextrous extended thumb safety, and instruction and installation manual.

Will work on all full-size 1911 series 70 and series 80 pistols.

\$150⁰⁰

HOW THE FAS SYSTEM WORKS:

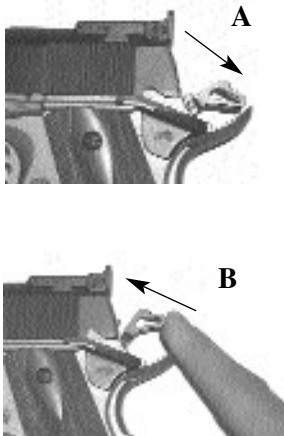

Once installed, the FAS system is simple and safe to use. As with any new device it is always best to function check the system in a gun with no magazine, and an empty chamber. Once you have properly unloaded the pistol, rack the slide to the rear, and then slide it forward as if you were loading a round into the chamber. Once you have done this the hammer will be cocked as in photo A. Then, simply push the hammer forward as shown in photo B. The safety then pops up, and the hammer will be resting forward in a “half-cock” position as shown in photo C. At this point, all safeties

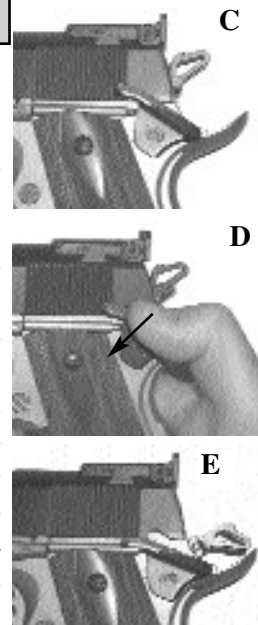

are engaged and the hammer is forward. This allows for carrying a live round in the chamber of your 1911 with the hammer down. The hammer and slide are both locked in position, with the firing pin blocked. When ready to fire simply disengage the safety in a normal 1911 fashion by pushing down on the thumb safety as shown in photo D. You will find that when you do this, unlike any other 1911 safety system anywhere, your hammer will *instantly* cock itself to the rear into a fully cocked position and is now ready to fire as shown in photo E. All this is accomplished in the blink of an eye!

This is a great system at any price. Try it once, and even the most staunch traditionalists will be converted.



OLYMPIC ARMS
SCHUETZEN PISTOL WORKS



SA46. EXTENDED THUMB SAFETY

- A. Black
- B. Stainless



\$22⁰⁰

Specialty Shop Section

Shop rate **\$45⁰⁰** hr. Plus parts
Special Order fee **\$50⁰⁰**

Complete safety check:

Includes detail strip, inspection, test fire and written evaluation.

\$90⁰⁰

SA50. AMBIDEXTROUS SAFETY

- Extended **\$47⁰⁰**
- A. Black
- B. Stainless



STOCKS (Grips)

PH B2 with Black Widow (Enforcer) **\$30⁰⁰**

PH B3 with Scorpion (Matchmaster) **\$30⁰⁰**



EB-2 ROSEWOOD GRIPS

Double-diamond checkered wooden grips made exclusively for us. **\$29⁰⁰**

SA55. COMMANDER HAMMER

- A. Black **\$26⁰⁰**
- B. Stainless



SA52 5" GUIDE ROD \$23⁰⁰



STAINLESS MAGAZINES

MATCHMASTER - MM01 7 rnd. **\$29⁰⁰**
ENFORCER - EEM-01 6 rnd

EXTENDED MAGAZINE CATCH

SA53 .100" longer than standard. **\$18⁰⁰**



C4551. LARGE BUTTON MAG CATCH

- A. Black
- B. Stainless **\$24⁰⁰**



SA47. EXTENDED SLIDE STOP

- A. Black
- B. Stainless **\$22⁰⁰**



SA48. SPW HIGH RIDE BEAVERTAIL W/ P.D.R.

- (Positive Disconnect Ridge)
- B. Stainless (only) **\$35⁰⁰**



SA49. SAFARI BEAVERTAIL GRIP SAFETY

- A. Black **\$24⁰⁰**
- B. Stainless



AS 1. ALLEN HEAD GRIP SCREWS

A = Black B = Stainless

AS 1-4A Blister pak set of 4 with wrench (steel)

AS 1-4B Blister pak set of 4 with wrench (stainless)



\$6⁵⁰

\$6⁰⁰

MAINSRING HOUSINGS

C4536 Aluminum Mainspring Housing for Gov't, Matchmaster **\$30⁰⁰**

C4536B Aluminum Mainspring Housing for Enforcer, complete **\$48⁰⁰**

C56SA: Smith & Alexander Checkered Mainspring Housing. Checkered to 20LPI. Available arched or flat. **\$42⁰⁰**

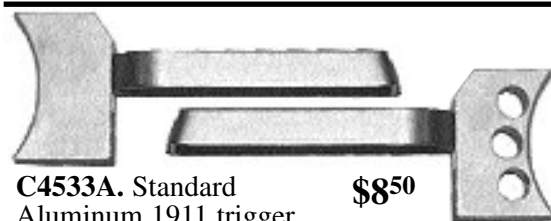

C4533A. Standard Aluminum 1911 trigger. **\$8⁵⁰**

C4533V. Adjustable Auto-Match 1911 trigger. Aluminum trigger, stainless steel bow. Complete with adjustable over-travel hex head screw and hex head wrench. **\$15⁵⁰**

LPA ADJUSTABLE SIGHTS Black serrated

- LPA-1A** White 3-Dot **\$50⁰⁰**
- LPA-2A** Adjustable Sight **\$50⁰⁰**
- LPA-3A** Front Sight **\$8⁵⁰**



4509-B. 45 BARREL LINK SET \$11⁰⁰ (PACK OF 5)

Kit Includes: #1 .268 ctr. to ctr. #2 .273 ctr. to ctr. #3 .278 standard centers #4 .284 ctr. to ctr. #5 .288 ctr. to ctr.

HHP-1 HARDENED HAMMER AND SEAR PINS \$15⁵⁰

These pins are heat-treated and ground to maximum diameter on the 1911 part print to allow for precise fitting of the hammer and sear (set of 2).

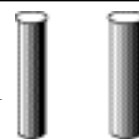



OLYMPIC ARMS
SCHUETZEN PISTOL WORKS



The Last 2 digits of the part number refer to the part number on the schematic

C4504	Extractor.....	16.20
C4505	Firing Pin.....	7.56
C4506	Firing Pin Spring.....	1.63
C4507	Firing Pin Stop.....	5.40
C4509	Barrel Link – Black.....	3.24
C4510	Barrel Link Pin.....	2.16
C4511A	Barrel Bushing – Black.....	16.20
C4511B	National Match Bushing	29.00
C4511C	Barrel Bushing – Stainless	22.00
C4511D	Stainless National Match Bushing	29.00
C4512	Recoil Spring (Wolff brand).....	11.00
C4513	Recoil Spring Guide – Gov’t	8.65
C4514A	Recoil Spring Cap – Black.....	8.65
C4514B	Recoil Spring Cap – Stainless.....	11.00
C4515	Ejector – Gov’t.....	6.48
C4516	Ejector Pin.....	1.30
C4517	Disconnecter.....	17.25
C4518	Sear.....	17.25
C4520	Hammer Strut.....	4.32
C4521	Hammer Strut Pin.....	1.30
C4522A	Slide Stop – Gov’t.....	16.20
C4522B	Slide Stop Stainless/Gov’t.....	5.30
C4523A	Magazine Catch – Black	16.00
C4523B	Magazine Catch – Stainless	17.30
C4524	Magazine Catch Spring.....	1.30
C4525	Magazine Catch Lock	3.75
C4526	Hammer Pin	1.30
C4527	Sear Pin	1.30
C4528A	Plunger Tube – Black.....	8.65
C4528B	Plunger Tube – Stainless.....	9.60
C4529	Slide Stop Plunger.....	1.36
C4530	Plunger Spring.....	1.65
C4531	Safety Plunger	1.65
C4532A	Thumb Safety – Black	17.30
C4532B	Thumb Safety – Stainless.....	19.45
C4533A	Aluminum Trigger.....	8.35
C4533V	Adjustable Match Trigger	15.00
C4535	Sear Spring	3.75
C4536A	Mainspring Housing – Black	28.00
C4537	Mainspring Cap Pin	1.30
C4538	Mainspring Cap	1.30
C4539	Mainspring	1.65
C4540	Mainspring Retainer.....	1.30
C4541	Mainspring Housing Retainer Pin.....	1.30
C4543	Grip Screw – Black.....	1.30
C4543A	Grip Screw – Stainless	1.30
C4544	Grip Screw Escutcheon – Black	1.30
C4544A	Grip Screw Escutcheon Stainless.....	1.30

Wholesalers and Manufacturers:
Call for OEM Quantity Discounts

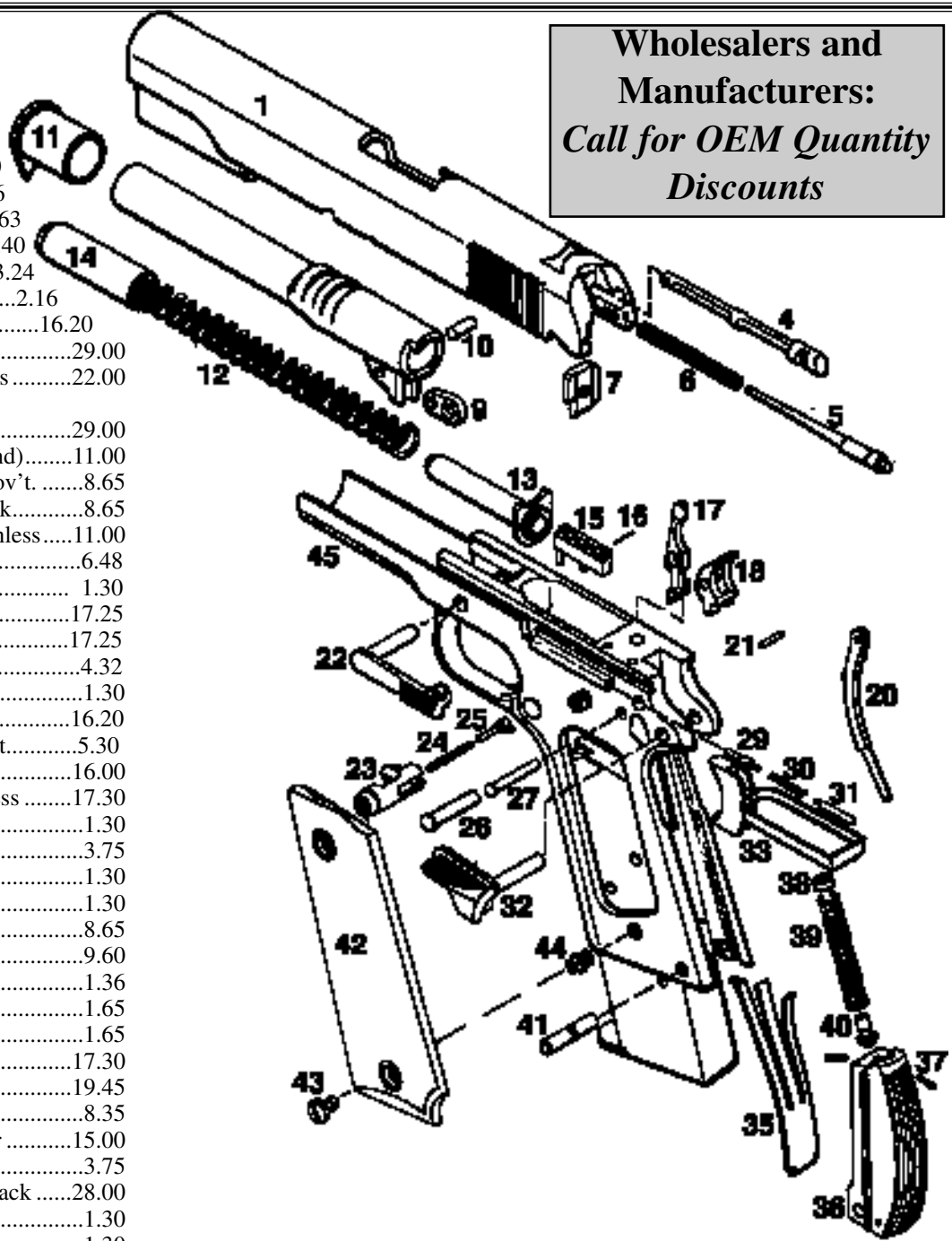

Parts Kits:
Parts kits include all parts necessary to finish a stripped slide or frame (less magazine and grips).
Frame Kit (please indicate stainless steel or black).....\$148⁰⁰
Slide Kit (please indicate stainless steel or black).....\$148⁰⁰

60 DAY SATISFACTION GUARANTEE AND LIFETIME WARRANTY



OLYMPIC ARMS
SCHUETZEN PISTOL WORKS



Olympic Arms is truly one of the world's premier barrel manufacturers. Whether we are talking about rifle or pistol barrels, Olympic's quality is hard to match anywhere. All Oly Arms pistol barrels are made from 416 stainless steel bar stock, not forgings, and are made right here in house. We do not rely on other people supplying us with blanks from which to build our barrels, we make everything right here, from scratch. The quality of or barrels speak for themselves. But just in case you are a "need to know" kind of person, over the years we have produced OEM (Original Equipment Manufactured) barrels for many brand name manufacturers including such famous names as Springfield Armory, Volquarzen, Wilson, and Caspian. Choose from any of the models and calibers you see below. Also, check in with us from time to time as we are always adding more options and models to the list throughout the year.

	Caliber	45 ACP	9mm	38 Super	357 Sig	40 S&W	10mm	Extra Length
Pistol Model								
1911		X	X	X	X	X	X	X
Glock								
17			X					X
19			X					
20						X	X	X
21		X						X
22			X		X	X		X
23			X		X	X		X
24			X		X	X		X
26			X					X
27			X		X	X		X
30		X						
29							X	X
31			X		X	X		X
32			X		X	X		X
34			X					X
35			X		X	X		X
Browning HP			X		X	X		X
Sig Sauer								
220		X						X
226			X					X
228			X		X	X		X
229			X		X	X		X
239			X					X
Beretta/Taurus								
92			X		X	X		X
96			X		X	X		X
H&K								
USP-9			X					X
USP-40					X	X		X
USP-45		X						X
HKC-9			X					X
HKC-45		X						X



ALL PISTOL BARRELS

\$114⁰⁰ea.

ADD \$20.00 FOR

.357 SIG



ALL PRICES AND SPECIFICATIONS SUBJECT TO CHANGE WITHOUT NOTICE • CALL 1-800-228-3471 • www.olyarms.com

ULTRAMAG

BARRELED ACTIONS AND CUSTOM RIFLES

ULTRAMAG Actions, Barreled Actions and Custom Rifles are available from Olympic Arms. The BBK-01 action is a super heavy weight Mauser style, double square bridge action, suitable for heavy magnum "Safari" calibers up to .505 Gibbs. Many options are available. See page 19 for barrel options. Select calibers are available with broach-cut National Match barrels. Call your sales representative for pricing and availability.



\$59400 Barreled actions starting
Action only at:
BBK-01 **\$95400**

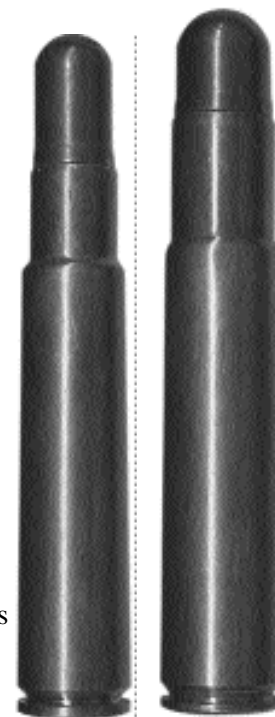

.416 Rigby (right) .505 Gibbs (far right) shown actual size.

- Features:**
- 3 Position Safety, Winchester Type
 - Fully Adjustable Timney Trigger
 - Mauser Claw Extractor
 - C Internal Ring
 - Controlled Round Feeding
 - Uncut Double Square Bridge
 - Magazine Capacity 6 Rounds .375 H&H
 - Magazine Length 3.85"
 - Bolt Face Cut to .532
 - Receiver: 4140 Chromemoly steel
 - Barrel Thread 1.10" x 12 T.P.I.

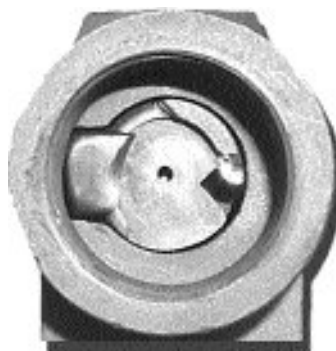

Ultramag bolt face showing it's huge size and built in strength. (above)

UMA-01. The BBK Ultramag Action is the starting point for some of the world's finest quality Safari Grade rifles made anywhere. Large enough to chamber up to the .505 Gibbs cartridges, and strong enough for more, the actions have been used to take dangerous game all over the world.

Constructed of high quality castings and manufactured of 4140 chromemoly steel, these actions are standard with a 3 position Winchester® style safety, positive claw extractors, and controlled round feed bolt system making them as reliable and safe as any action ever made.

Available as actions only (in the white), or assembled barreled actions in a variety of calibers. Call our rifle shop for all of the details. Please allow minimum 4-6 weeks delivery for actions, and minimum 90 days for barreled actions.

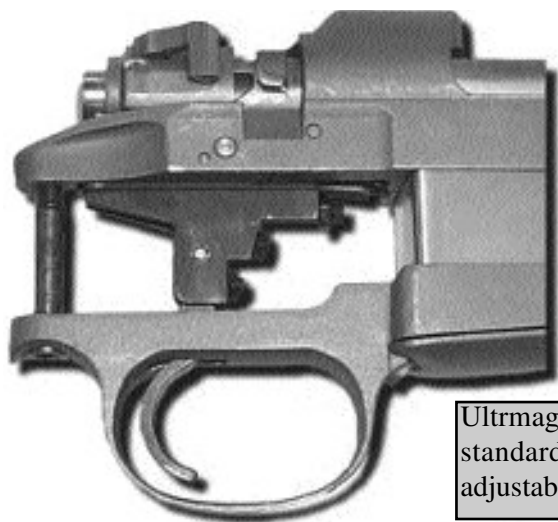
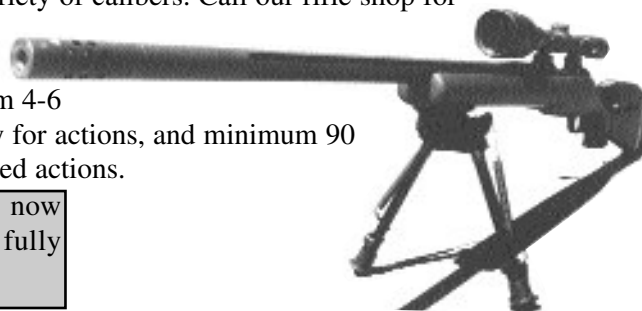

Ultrmag Magnum Action now standard with Timney fully adjustable triggers. (left)

ULTRAMAG

ACTIONS AND BARRELED ACTIONS

ULTRAMAG actions and barreled actions are available from **Olympic Arms**. The BBK-01 action is a super heavyweight Mauser style, double square bridge action, suitable for heavy magnum "Safari" calibers up to .505 Gibbs.

This action is a controlled round feed action with positive claw extractor, that is investment cast of 4140 chromemoly steel. These actions are delivered in the white

and are ready for bluing or parkerizing. These actions are used by Safari Game hunters around the world. Superior quality and strength for half the price of many competitors actions.

Many options are available. Select calibers are available with broach-cut National Match barrels. Call your Oly sales representative for pricing and availability.

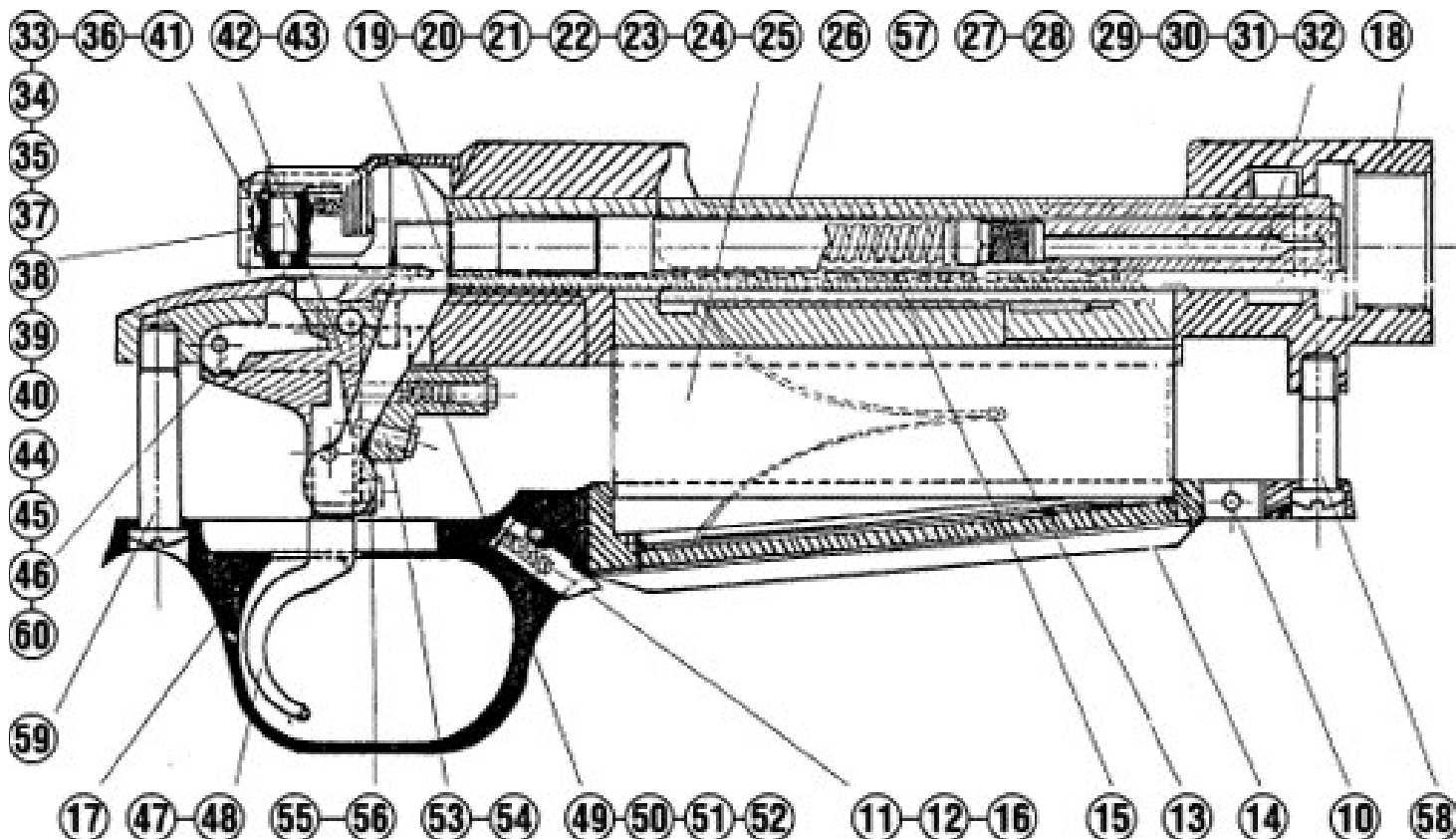

BBK PARTS LIST

BM-1057 Box magazine	\$22.50	BM-1012 Spring, floor plate latch retainer	\$ 1.50	BM-1032 Nut, knurled firing pin	7.80
BM-1058 Screw, front guard	5.65	BM-1013 Spring, magazine follower	11.00	BM-1033 Shroud, striker	51.00
BM-1059 Screw, rear guard	5.65	BM-1014 Cover, floor plate	39.00	BM-1034 Cocking piece, striker	15.00
BM-1018 Receiver body	* *	BM-1015 Follower, magazine	10.20	BM-1035 Lever, safety	15.00
BM-1019 Arm, ejector	10.25	BM-1016 Latch, floor plate	7.80	BM-1036 Pin, cocking piece to firing pin	1.10
BM-1020 Spring ejector	1.50	BM-1017 Guard, trigger	58.20	BM-1037 Screw, safety lever to shroud	1.20
BM-1021 Ball, ejector	1.50	BM-1026 Bolt body	* *	BM-1038 Spring, safety lever	1.50
BM-1022 Stop, bolt	20.00	BM-1027 Collar, extractor	9.00	BM-1039 Plunger, safety lever	5.40
BM-1023 Pin, bolt stop pivot	3.00	BM-1028 Extractor, cartridge	27.00	BM-1040 Ball, shroud detent	5.40
BM-1024 Spring, bolt stop	1.50	BM-1029 Pin, firing	39.00	BM-1041 Spring, shroud detent	1.55
BM-1025 Pin, ejector pivot	3.00	BM-1030 Spring, firing pin	9.00	BM-1048 Trigger, Timney	54.00
BM-1010 Pin, floor plate pivot	1.50	BM-1031 Locking collar, firing pin	5.40	BM-1102 Pin, trigger to receiver	3.00
BM-1011 Pin, floor plate latch retainer	1.50				



OLYMPIC ARMS
SCHUETZEN PISTOL WORKS



Whitney Wolverine



\$279⁰⁰

Shown here is a photo of an actual new, pre-production Whitney Wolverine from Olympic Arms.

Available for delivery Spring 2004.

New Features:
Black polymer frame
Vented Rib
Dove tail rear sight

Here it is again. We have been touting the return of the Whitney Wolverine pistol for years, and here it is to begin shipping in 2004. Not flood, nor fire nor earthquake could keep this pistol from seeing the light of manufacturing day.

The original Whitney Wolverine pistols first went into production in 1956. They were a huge hit with the consumers. Its radical "space age" design was easy on the hand ergonomically, and pointed quite well for most shooters. With new technology in cast aluminum available after WWII, the Wolverine was a very lightweight and strong handgun design. Its shape alone attracted many consumers.

However, the Wolverine pistol quickly went out of production because of distribution problems, and because a rival pistol was shortly introduced afterwards that sold for just a few dollars less.

With years of development now behind it, the Whitney is readying itself for release. The new Wolverine pistol

will first be manufactured with a high-strength polymer frame. It is lightweight and very durable, and molded in an attractive black color.

The 22 LR ammo will be delivered through an all metal magazine body that houses 10 rounds. Current production magazine will be 100% interchangeable with earlier production Whitney pistols.

Easy disassembly of the barrel unit allows for the use of interchangeable barrels. Barrels can be swapped without the use of tools in only seconds! Add a longer barrel, or ported barrels that will be made available at a later date.

This once highly sought after pistol has not lost its desirability amongst some old time shooters, and will now attract a whole new generation to its following.

Once called, "*The most reliable, best shooting, best pointing little .22 pistol I've ever handled*" by the late Rex Applegate, the Whitney Wolverine makes a great plinker, farm hand, or hoke defense pistol.

60 DAY SATISFACTION GUARANTEE AND LIFETIME WARRANTY



OLYMPIC ARMS
SCHUETZEN PISTOL WORKS



• Widely acclaimed as one of the best-pointing, easiest-shooting handguns ever made, the Wolverine is the perfect training and target pistol. A ten-round magazine of .22 LR make it an inexpensive and enjoyable gun to carry any day, anywhere. The parts seen listed below are new production Whitney wolverine parts manufactured for the new Olympic Arms Whitney Pistol. While most parts are made to be fully interchangeable with original Whitney Wolverine pistols

PART #	PART NAME	PRICE	PART #	PART NAME	PRICE
JLM-004	Magazine Assembly	\$32.35	JLM-020	Trigger	10.75
JLM-005	Barrel	\$62.40	JLM-021	Sear Bar	13.15
JLM-006	Barrel Seat	3.72	JLM-022	Magazine Shell	**
JLM-007	Side Plate	9.00	JLM-023	Magazine Bottom	**
JLM-008	Nut	6.60	JLM-024	Magazine Follower	**
JLM-009	Tube	29.50	PART # PART NAME		
JLM-010	Breech Block	32.00	JLM-025	Magazine Bottom Lock	**
JLM-011	Extractor	5.95	JLM-026	Magazine Insert	**
JLM-012	Firing Pin	10.75	JLM-027	Cocking Piece	\$15.50
JLM-014	Breech Pin	3.54	JLM-028	Strut	3.54
JLM-015	Firing Pin Lock	3.00	JLM-029	Hammer Spring Plunger	3.50
JLM-016	Frame	N/A	JLM-030	Trigger Spring Plunger	2.50
JLM-017	Action Frame	22.74	JLM-031	Magazine Catch	5.95
JLM-018	Hammer	19.00	JLM-032-1	Mainspring	7.15
JLM-019	Sear	7.80	JLM-032-2	Extractor Spring	1.50
			JLM-032-3	Hammer Spring	1.50
			JLM-032-4	Magazine Spring	1.50
			JLM-032-5	Trigger Spring	1.50
			JLM-032-6	Cocking Plunger Spring	1.50
			JLM-033-1	Sear Pin	1.50
			JLM-033-2	Strut Pin	1.50
			JLM-033-3	Magazine Catch Pin	1.50
			JLM-033-4	Hammer Pin	1.50
			JLM-033-5	Safety Lock Pin	1.50
			JLM-034	Extractor Plunger	1.50
			JLM-035	Trigger Connector	1.50
			JLM-036	Sear Spring	3.90
			JLM-037	Trigger Pin	1.50
			JLM-038	Barrel Key	3.00
			JLM-039	Ejector	6.30
			JLM-040	Pistol Grips	27.00
			JLM-041	Screw, Pistol Grip	2.70
			JLM-042	Screw, Side Plate	2.70
			JLM-043	Magazine Disconnect	5.70
			JLM-044	Hammer Spring Seat	1.80
			JLM-045	Barrel Locking Plunger	2.10
			JLM-046	Magazine Cross Lock	POR
			JLM-047	Rear Sight	5.40
			JLM-048	Spring Seat Pin	1.50
			JLM-049	Magazine Shell Assembly	POR
			JLM-050	Safety	9.50

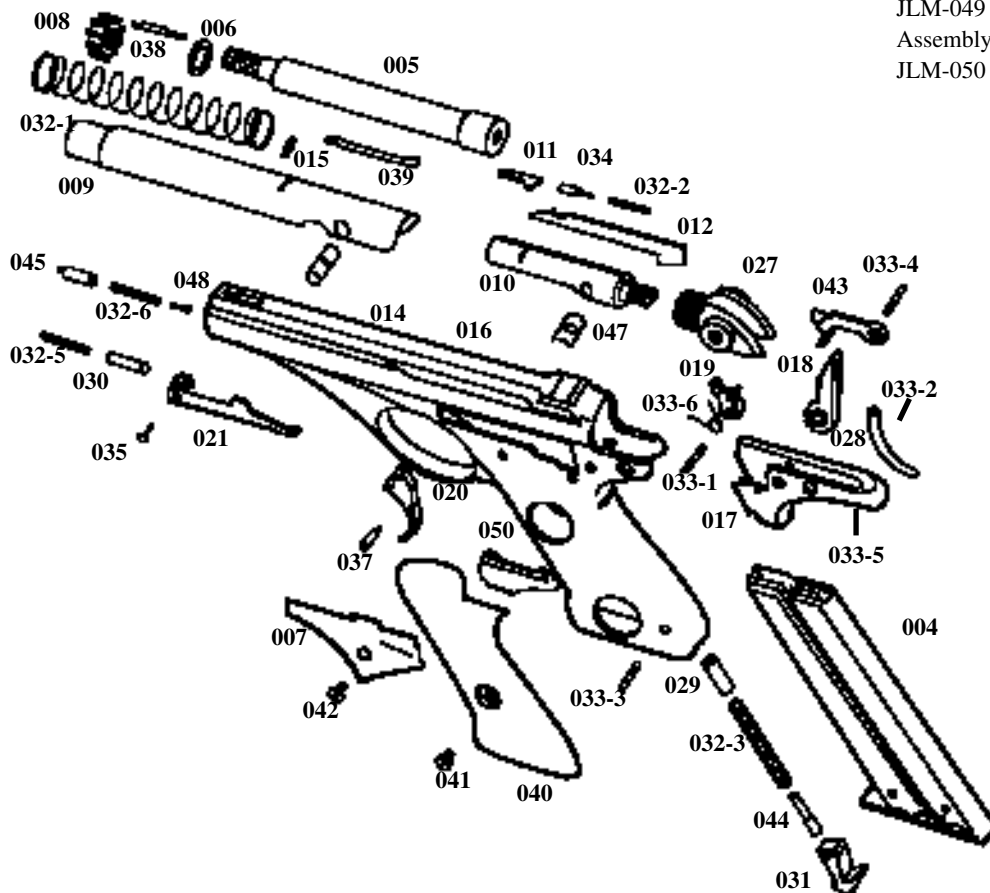

ALL PRICES AND SPECIFICATIONS SUBJECT TO CHANGE WITHOUT NOTICE • CALL 1-800-228-3471 • www.olyarms.com