

Catalog 2004 V.1



**Bushmaster
CARBON 15
Rifles & Pistols**

Bushmaster Firearms



**New Bushmaster BAR-10
.308 Rifle & Carbine**

For fastest order processing, visit our Website and order direct from our online catalog at...

<http://www.bushmaster.com>

Telephone Orders 24 Hours: **1-800-998-7928**

Fax Orders: **1-207-892-8068**

Customer Service: **1-800-883-6229**

(Customer Service Phone Hours: 8:30 - 6:00 Monday thru Friday E.S.T.)

Bushmaster Firearms, Inc. • 999 Roosevelt Trail • P.O. Box 1479 • Windham, Maine 04062 • U.S.A.

E-mail Directory: Customerservice@bushmaster.com Techsupport@bushmaster.com

Export@bushmaster.com Webmaster@bushmaster.com

**Introducing the Bushmaster "LADY"
Carbon 15 Rifle**



**For Orders 24 Hours
Call 1 800 998 7928
Or see us on the Internet at:
<http://www.bushmaster.com>**



999 Roosevelt Trail, Windham, ME 04062

- Bushmaster Rifles & Carbines
- Bushmaster Carbon 15 Rifles & Pistols
- Bushmaster Modular Accessories
- Bushmaster DQM Competition Rifle
- Competition Parts & Accessories
- AR15/M16 Parts & Accessories
- Scopes, Sights & Mounts
- Gunsmithing Tools & Supplies
- Tactical Shotgun Accessories

**All the Quality, Accuracy and Durability
you've come to expect from
Bushmaster.
Now, just MORE OF IT!**



BAR-10 .308 Cal.
A3 Type Rifles and
Carbines are fitted with
a three Rail Gas Block to
avoid interference with optics,
and to offer accessory mounting
points.

The new Bushmaster BAR-10 .308 Caliber 20" Barrelled Rifle is available in either a flat-top Picatinny Railed A3 configuration (shown here), or the A2 Type Carry Handle Receiver configuration. The 16" Barrelled BAR-10 Carbine is also configured in the A3 flat-top and A2 Handle Type (as shown below). Both are fitted with the solid A2 Trapdoor Buttstock. The forend on the rifle is a standard full-length ribbed composite type; the carbine features a mid-length handguard.

Scope shown on
.308 Rifle is
optional.
See Pg. 65

**BUSHMASTER BAR-10
.308 Win./7.62 NATO Cal.
RIFLE FEATURES...**

- Forged 7075-T6 Aluminum Upper and Lower Receivers for strength and durability
- Alloy Steel Barrel - Button Rifled 1 in 10" R. H. Twist - 4 Lands/Grooves - with AK74 Muzzle Brake
- Functional Controls Similar To AR15 Type Rifle offering Excellent Ergonomics and Familiarity
- Ambidextrous Magazine and Bolt Release Controls For Ease Of Use and Flexibility
- Over 50% of BAR-10 Parts are Common to the AR15 for Simplicity and Availability
- Accepts Readily Available FN-FAL Magazines for Economy and Reliability - shipped with 20 Round
- Overall Length - 20" Bbl. Rifle - 42.75" [108.5 cm]
- Weight w/o Mag. - 20" Bbl. Rifle - 9.57lbs. [4.35 kg]

BUSHMASTER BAR-10 .308 RIFLE - Law Enforcement / Military Models

- Bushmaster BAR-10 RIFLE - A3 Type (BCWA3S 308 20AK) Suggested Retail Price... \$1785.00**
- Bushmaster BAR-10 RIFLE - A2 Type (BCWA2S 308 20AK) Suggested Retail Price... \$1760.00**
- Bushmaster BAR-10 CARBINE - A3 Type (BCWA3S 308 16AK) Suggested Retail Price... \$1775.00**
- Bushmaster BAR-10 CARBINE - A2 Type (BCWA2S 308 16AK) Suggested Retail Price... \$1750.00**

BUSHMASTER... the Best By a Long Shot! 1 800 998 7928

Letters/Correspondence to: P.O. Box 1479 / Windham, Maine 04062 U.S.A.

All Packages to: 999 Roosevelt Trail / Windham, Maine 04062 U.S.A.

E-mail Directory:

Customerservice@bushmaster.com
Export@bushmaster.com

Techsupport@bushmaster.com
Webmaster@bushmaster.com

Orders by FAX: 207-892-8068



Previews of "Coming Attractions" from Bushmaster

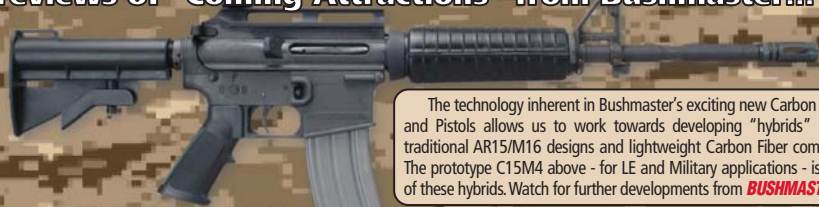

The technology inherent in Bushmaster's exciting new Carbon 15 Rifles and Pistols allows us to work towards developing "hybrids" between traditional AR15/M16 designs and lightweight Carbon Fiber components. The prototype C15M4 above - for LE and Military applications - is the first of these hybrids. Watch for further developments from **BUSHMASTER**...

Order Toll-Free 24 Hrs.: 1 800 998 7928 or on the Internet: www.bushmaster.com

Configurations for every Law Enforcement need...



20" Bbl. M16A2 Type Rifle

RCWA2S 20 M.S.R.P. - \$950.00

Semi-Auto 5.56mm - .223 Rem. Cal. / Solid A2 Buttstock
30 Rd. Mag. / 20" Heavy Bbl. / 39.5" overall length
weight without magazine - 7.43 lbs.



Patrolman's Carbine - A3 Type

RCWA3F 16M4 M.S.R.P. - \$1080.00

Semi-Auto 5.56mm - .223 Rem. Cal. / Telestock / 30 Rd. Mag.
16" M4 Profile Bbl. / Includes A3 Removable Carry Handle
32.5" length (retracted stock) / weight w/o mag. - 6.7 lbs.



16" Bbl. A2 Type Carbine

RCWA2F 16 M.S.R.P. - \$950.00

Semi-Auto 5.56mm - .223 Rem. Cal. / Telestock / 30 Rd. Mag.
16" Heavy Bbl. / 32.5" overall length (retracted stock)
weight w/o mag. - 6.93 lbs.



M4/A3 Type Carbine

RCWA3F 14M4 M.S.R.P. - \$1080.00

Semi-Auto 5.56mm - .223 Rem. Cal. / Telestock / 30 Rd. Mag.
14.5" Bbl. / Includes A3 Removable Carry Handle
30.875" length (retracted stock) / weight w/o mag. - 6.57 lbs.



11.5" Bbl. Entry Carbine

RCWA2F 11.5F

Semi-Auto 5.56mm - .223 Rem. Cal. / Telestock / 30 Rd. Mag.
11.5" Bbl. / 27.75" length (retracted stock)
weight w/o mag. - 6.46 lbs.



Bushmaster Rifles and Carbines are available with either A2 (Solid Carry Handle) configuration, or in the A3 Type configuration with Removable Carry Handle (shown right - off receiver). Due to post height, A3 type sights are 1/2 M.o.A. with elevation range to 600 yards.



Orders: 1-800-998-7928 • Fax: 207-892-8068
E-mail: LE@bushmaster.com • www.bushmaster.com

Bushmaster Law Enforcement Products Orders: 1 800 998 7928



The last year has brought many changes to our country, the world, and our perceptions of it all. With so many distractions, we need to make sure not to lose sight of the basic strengths upon which our nation and our business community were built.

For 26 years, BUSHMASTER has been dedicated to building the highest quality products... for Defense – for Law Enforcement – for Competition – for the enjoyment of the shooting public. And our continued growth is still predicated on supplying our fine customers with products that deliver Accuracy, Reliability, and Value. The fact that we've become known for superb Customer Service should indicate our dedication to those basics.

This past summer, Bushmaster opened a completely new division in Lake Havasu, Arizona, and in these pages you'll find the exciting new Carbon 15 Rifles and Pistols that are produced there. The Receivers, Buttstocks, Forends and some small parts of these lightweight firearms are molded of incredibly strong and durable Carbon Fiber composite. When combined with accurate Stainless Steel Barrels and proven Bushmaster AR components, they create a new form of the AR type rifle that brings exciting new developments to the Defense, Law Enforcement, and sport shooting markets. "The Lady" is one of those unique new products - dedicated specifically to the growing numbers of women shooters today.

Along with opening a new plant, we've developed the BUSHMASTER .308 Caliber Rifle, – an exciting new large caliber venture sure to be of interest to all Bushmaster shooters. So, you see we haven't been resting on our laurels.

As always, you can order from this catalog, or by phone, or the fastest method – online at www.bushmaster.com Many Internet orders are processed and shipped the day they are received. Customer Service and Technical Support inquiries can also be handled quickly and efficiently by e-mail. Bushmaster Gift Certificates can now make it easier to please the shooters in your family (see details below).

Thanks again to all our customers for making Bushmaster your first choice – for defense – for competition – for Law Enforcement – for the highest quality AR15 type rifles.



Member - National Association of Sporting Goods Wholesalers



Member - Sportsman's Alliance of Maine



Member - National Shooting Sports Foundation



Member - National Defense Industrial Association

Made with Pride in the U.S.A. and Proud to be Helping our Armed Forces



- Bushmaster Carbon 15 Rifles, Pistols & Accessories 2
- Bushmaster Rifles & Carbines 5
- Bushmaster Bullpup 13
- DCM Rifle & Competition Parts 15
- Bushmaster Receivers & Parts 20
- Upper Receiver/Barrel Assemblies 26
- Bushmaster Barrels 32
- Muzzle Brakes & Flash Suppressors 37
- Parts Reference Schematic 40
- Magazines & Mag Accessories 42
- Pistol Grips & Buttstocks 46
- Handguards & Accessories 52
- Slings & Bipods 55
- Gunsmithing Tools & Supplies 57
- Tactical Shotgun Parts & Accessories 62
- Sights, Scopes and Mounts 64
- Bushmaster Modular Accessories System 70
- Bushmaster Apparel & Accessories 74
- Customer Service / Exchanges / Warranty 77
- Mail Order Form 78
- Ordering Instructions 79
- Bushmaster Law Enforcement Models 80

BUSHMASTER FIREARMS, INC.

999 Roosevelt Trail • P. O. Box 1479

Windham, Maine 04062

Orders: 1-800-998-7928

Fax: 207-892-8068

E-mail: Info@bushmaster.com

Customerservice@bushmaster.com

LE@bushmaster.com

Export@bushmaster.com

Webmaster@bushmaster.com

Orders: 1 800 998 7928
www.bushmaster.com

Major Credit Cards Accepted



Bushmaster Gift Certificates can be the ultimate gift for the shooter in your life – give them the freedom of choice with a Bushmaster Firearms Gift Certificate (available in any amount above \$10). Redemption of these certificates is very flexible – easily accomplished through our website, or by phone, fax or mail order. Just be sure to provide us the Certificate Number when placing your order (the actual certificate is not required - just the Certificate number from its lower right corner).

• **Phone Orders** – When ordering through our 800 number (1 800 998 7928), please tell our sales representative that you have a Gift Certificate and would like to use it, and provide us with the Gift Certificate Number. If your purchase total is higher than the Gift Certificate amount, you'll be asked for a Credit Card Number, Expiration Date and billing address so that we can charge any difference to your Credit Card.

• **Mail and Fax Orders** – When ordering via Mail or Fax, just write the Certificate Number next to the payment method.

• **Internet Orders** – choose Gift Certificate as your Payment Method and enter the Certificate Number in Certificate # Box.

Note: Bushmaster Gift Certificates can only be redeemed for Merchandise (not redeemable for cash), and are valid for one year from date of issue. See complete details on the internet, www.bushmaster.com or call 1 800 998 7928



Bushmaster Carbon 15 Rifles & Pistols...

Featherweight 5.56mm/.223 Caliber Rifles with Carbon Fiber Components & Stainless Steel Barrels

Bushmaster's Carbon 15 Rifles and Pistols boast features not found in any other AR15 type firearm...

Carbon 15 Components... Carbon 15 is an incredibly durable carbon fiber composite material - 40% stronger and 40% lighter than the aircraft aluminum used in other versions of these firearms. Initially developed in the aerospace industry to create parts for jets and spacecraft, Bushmaster molds it to produce the Upper and Lower Receivers; Buttstock; Forend; Charging Handle and other small components of the Bushmaster Carbon 15 line. This Carbon 15 composite is so light that complete rifles can weigh as little as 3.9 lbs., and our pistol tips the scale at only 46 oz. yet it has plenty of strength to withstand the powerful 5.56mm/.223 Rem. cartridge. Also, unlike anodized aluminum, Carbon 15 is the same matte black throughout and has no surface finish that can wear off.

Stainless Steel Barrels... All Bushmaster Carbon 15 Rifles and Pistols feature Match Grade 416 Stainless Steel Barrels. They are precision machined, polished, and button rifled 1 turn in 9" to offer optimum accuracy with the wide range of 5.56mm and .223 Remington ammunition available. The corrosion resistance and durability of stainless steel will provide the shooter with years of satisfaction. On some models, the barrels are fluted to further reduce weight and improve cooling capabilities by increasing the surface area. In addition, the grooves in fluted barrels serve as mounting points for several of the light and laser mounts offered as accessories to these rifles and pistols.

The Carbon 15 Rifles...



Overall Length - 35"
Weight without magazine
or compensator - 4.3 lbs.

**HIGH TECH...
Carbon Fiber 15
Molded Receivers
& Components**

- 16" Stainless Steel Match Grade Barrel - 1 x 9 twist - Fluted
- Quick Detach Compensator
- Hogue® "OverMolded" Pistol Grip
- Chrome Plated Bolt Carrier
- Full Length Picatinny Optics Mounting Rail
- Integral Dual Aperture Rear and Blade Front Sights - adjustable for windage and elevation
- Ambidextrous Safety Machined from Aluminum Alloy
- Tactical "Multi-Carry Mode" Black Nylon Sling included

Bushmaster Carbon 15 Type 97S Rifle... Part# AZ-C15R97S

Manufacturers Suggested Retail Price... **\$1192.00**



Overall Length - 35"
Weight without magazine
or compensator - 3.9 lbs.

**STAINLESS STEEL...
Match Grade Barrels
with or without Fluting**

- 16" Stainless Steel Match Grade Barrel - 1 x 9 twist - Fluted
- Quick Detach Compensator
- Hogue® "OverMolded" Pistol Grip
- Chrome Plated Bolt Carrier
- Safety Controls Marked on Both Sides of Receiver
- Receiver Length Picatinny Optics Mounting Rail

Bushmaster Carbon 15 Type 97 Rifle... Part# AZ-C15R97

Manufacturers Suggested Retail Price... **\$1039.00**



Overall Length - 35"
Weight without magazine
or compensator - 4 lbs.

**FEATHERWEIGHT...
Rifles - less than 4 lbs.
Pistols - 46 oz.**

- 16" Stainless Steel Match Grade Barrel - 1 x 9 twist
- Quick Detach Compensator
- Safety Controls Marked on Both Sides of Receiver
- Receiver Length Picatinny Optics Mounting Rail

Made With Pride
In The U.S.A. 

Bushmaster Carbon 15 Type 21 Rifle... Part# AZ-C15R21

Manufacturers Suggested Retail Price... **\$916.00**

Lockable Carrying Case included... a \$16.95 Value Bushmaster Rifles are shipped with 10 Round Magazine, Operation & Safety Manual, Case & Warranty Card



Bushmaster Quality... This innovative and high tech product line has undergone extensive development to be worthy of the Bushmaster name. We have modified the Receivers so that conventional AR15 type rifle components will interchange with the Carbon 15 line. We have incorporated superior quality Bushmaster Bolts; Barrel Extensions; Hammers; Triggers and other Lower Receiver parts into our Carbon 15 firearms to assure the purchaser of the highest quality, most durable, rifles and pistols possible.

Bushmaster Warranty... We're confident of the superior quality and durability of these fine firearms, and we back the Bushmaster name on these rifles and pistols with the our One Year Warranty.

The "Lady" – a special Bushmaster Carbon 15 model...

The Bushmaster Carbon 15 Rifles – because they are so lightweight, easy to handle and soft recoiling – are particularly well suited to the needs of women and smaller statured shooters. To appeal to the women, we have developed the "Lady" – a special Bushmaster featuring a one-of-a-kind pattern reminiscent of what the company chairman has seen on designer handbags. Add to that the bright touches of nickel plating on some receiver controls and pins, a chrome plated bolt carrier, and a comfortable rubber recoil pad color-coordinated to match the rifle's decorative pattern, and you have the most unique Bushmaster on the range. At only 4 lbs., its a pleasure to shoot and handle, yet is all Bushmaster in terms of quality, durability and value. An optional foam lined fabric carrying is available (shown below) - also color coordinated to the "Lady" - in chocolate brown with white webbing handles and white zipper. The Bushmaster "Lady" – available only through FFL Dealers – is shipped with a 10 round magazine, Operation / Safety Manual and Warranty Card in a Bushmaster carrying case.

Carbon Fiber 15 Molded Receivers & Components
Stainless Steel Match Grade Barrel

Bushmaster "Lady"... (Part# AZ-C15R21C)
 Manufacturers Suggested Retail Price... **\$989.00**
Matching Fabric Carrying Case... (AZ16902) **\$39.95**



The "Lady" Specifications:

Caliber 5.56 mm / .223 Rem.
 Overall Length 35 inches
 Barrel Length 17" w/ muzzle brake
 Weight w/o mag. 4 lbs.
 Operating Mode Gas Operated - Semi-Automatic

Bushmaster Carbon 15 Pistols...

These unique Handguns... utilize the same Carbon 15 technology and rugged features as the Bushmaster Carbon 15 Rifles – which make for an incredibly light, durable and power-packed handguns. The Upper and Lower Receivers; Receiver Extension; Charging Handle and other small components are all molded of the featherweight but durable Carbon 15 composite. The 7.25" 5.56mm/.223 Rem. caliber barrels of these Pistols are Match Grade 416 Stainless Steel – polished, and button rifled 1 turn in 9", and on the Type 97 model, the barrel is fluted for weight reduction and increased cooling. The fluted barrel grooves will allow attachment of the special light and laser mount accessories (shown on next page). Fixed Ghost Ring Rear and Blade Front Sights are fitted to both Carbon 15 model pistols. The same Quick Detach Muzzle Brake as found on the Carbon 15 Rifles is utilized with great effectiveness to control muzzle rise and felt recoil in these pistols. Its spring loaded, ball detent locking collar is simply pulled forward to release the brake from the barrel. The Safety Lever (operated from the left side) has clear, bright markings – Fire or Safe – on both sides of the Receiver. As with other AR15 type firearms, the Carbon 15 Pistols feature easy takedown and cleaning by sliding out the two receiver pins - front and rear. Bushmaster's Carbon 15 Pistols – available only through FFL Dealers – are shipped with a 10 round magazine, Operation / Safety Manual and Warranty Card in a foam lined cardboard case.

Bushmaster Carbon 15 Type 97 Pistol Part# AZ-C15P97



**High Tech Carbon Fiber
 Molded Receivers
 & Components**

Overall Length - 20"
 Weight without mag.
 or compensator
 46 ozs.

- 7.25" Stainless Steel Match Grade Barrel - 1 x 9 twist - Fluted
- Quick Detach Compensator
- Hogue® OverMolded™ Pistol Grip
- Chrome Plated Bolt Carrier
- Ghost Ring Rear and Blade Front Sights

Manufacturer's Suggested Retail Price... **\$892.00**

Stainless Steel Barrels / Gas Operated Semi-Automatic Operation

Bushmaster Carbon 15 Type 21 Pistol Part# AZ-C15P97

- 7.25" Stainless Steel Match Grade Barrel - 1 x 9 twist
- Quick Detach Compensator
- Ghost Ring Rear and Blade Front Sights
- Standard A2 Pistol Grip

Manufacturer's Suggested Retail Price... **\$825.00**



Overall Length - 20"
 Weight without mag.
 or compensator
 47 ozs.

Bushmaster Carbon 15 Rifle & Pistol Accessories...



Made With Pride In The U.S.A.

A. Silent Sling...\$39.95 (AZ723) This quality tactical sling – though standard on the Type 97S Rifle - will fit any other Bushmaster Carbon 15 Rifle. Made of durable, black ballistic nylon, it is easy to attach with its Velcro straps and offers multiple carry modes.

B. Picatinny Optics Mounting Base for Carbon 15 Pistols... \$49.95 (AZ716) Machined from anodized aircraft aluminum, this Picatinny Rail Mount attaches by sliding onto the Pistol Upper, then locks in place with a screw. It provides a rock solid base for any standard optics and will remain true to zero when removed and reinstalled. With this see-thru design mount in place, the iron sights on the pistol remain functional.

C. Extra Length Optics Rail with Integral Sights (as on Carbon 15 Type 97S Rifle)... \$139.95 (AZ15198) This Picatinny configuration rail can be added to either the Carbon 15 Type 97 or Type 21 Rifles as a factory installation (some drilling / tapping required) to offer the best of both integral iron sights and unlimited optics mounting options. Machined from aircraft aluminum, and finished with matte black hard anodize. The rear sight is an AR type dual aperture flip-up with windage adjustment, and the front sight is an AR standard elevation adjustable post.

D. Recoil Pad for Carbon Buttstock... \$18.95 (2698828) This molded black rubber recoil pad offers extra shooting comfort and a slip-on fit for all Carbon 15 buttstocks.

E. Carbon 15 Youth Sized Buttstock... \$24.95 (AZ15279) Perfectly sized for the younger shooter, or smaller woman, this Carbon 15 molded buttstock easily replaces the standard stock on all Bushmaster Carbon 15 rifles by releasing the receiver locking lever. It's 8 1/4" overall length yields an 11 1/4" trigger pull length.

F. Carbon 15 Ambidextrous Safety and Safety Lever... The complete **Ambidextrous Safety Assembly** (AZ724) **\$31.60** can be purchased as a spare or replacement part for your Carbon 15 firearm, or just the Lever can convert existing safeties on Type 21 or 97 Pistols and Rifles to achieve ambidextrous functioning in "weak hand" mode. Machined of aircraft quality aluminum – black anodized. **Safety Lever only** (AZ724L) **\$11.95** is molded of Carbon 15.

G- H- I. Light & Laser Mounts... These Mounts clamp to the barrel fluting on Type 97 Pistols and Type 97 / 97S Rifles to offer a solid mounting point for the various lights and lasers listed. The **SureFire Mount – G.** (AZ718) **\$24.95** takes 1" diam. flashlights (they recommend their #650 Universal Weapon Light). The **Mag-Lite Flashlight Mount – G.** (AZ717L) **\$24.95** holds 3/4" diam. lights, and the **Laser Mount – I.** (AZ719) **\$24.95** accepts 3/4" diam. laser sighting units. All mounts are machined from aluminum, include allen head locking screws and are black anodize finished.

Bushmaster Desert Camo Carbine...



Specifications:

Caliber 5.56 mm / .223 Rem.
Overall Length 34.875 inches (88.6 cm)
Barrel Length 16.5" (41.9 cm) w/brake
Weight w/o mag. 6.59 Lbs. (2.99 kg)
Operating Mode Gas Operated - Semi-Automatic

Bushmaster's new Desert Camouflage Pattern is available on our popular XM15 E2S M4 Type Post-Ban Carbine. The Buttstock, Pistol Grip and Forend feature a permanently applied Desert Camo pattern unique to the AR15 market, and this model is available in either the A3 Type configuration (shown above) with Removable Carry Handle, or the Solid Carry Handle A2 Type. This Carbine features a 14.5" M4 barrel (chrome lined in both bore and chamber) machined in the distinctive M4 profile with permanently attached Mini Y Comp muzzle brake. Total barrel length – with muzzle brake – is 16.5" to comply with Post-Ban regulations. Bushmaster's Desert Camo Carbine is shipped in a hard plastic, lockable storage case complete with Black Web Sling, 10 Round Magazine, Operating and Safety Instruction Manual and One Year Warranty, and is available through FFL dealers.

Bushmaster M4A3 Type Desert Camo Carbine... (PCWA3S 14M4MYDC) Suggested Retail Price... \$1100.00

Bushmaster M4A2 Type Desert Camo Carbine... (PCWA2S 14M4MYDC) Suggested Retail Price... \$1200.00

Bushmaster RealTree® Camo Rifle...



Specifications:

Caliber 5.56 mm / .223 Rem.
Overall Length 38.25 inches (97 cm)
Barrel Length 20" (51 cm)
Weight w/o mag. 8.2 Lbs. (3.72 kg)
Operating Mode Gas Operated - Semi-Automatic

BUSHMASTER'S REALTREE® GREY HARDWOODS PATTERN CAMO RIFLE... Our 20" barreled Target Model above is camouflaged with a RealTree® Grey Hardwoods pattern Buttstock, Pistol Grip and Forend. The 5.56mm/.223 caliber, chrome lined, 1 x 9 twist barrel delivers all the accuracy for which Bushmaster has become famous, and this unique rifle is available in A2 or A3 Type configurations (the A3 Type includes the Removable Carry Handle with 1/2 M.o.A. rear sight). Shipped with 10 round magazine, sling and manual in a Bushmaster lockable carrying case.

Bushmaster RealTree® Camo Rifle - A2 Type (PCWA2S 20C) Suggested Retail Price... \$1055.00

Bushmaster RealTree® Camo Rifle - A3 Type (PCWA3S 20C) Suggested Retail Price... \$1155.00

Bushmaster – The Best by a Long Shot! Here's why...

Barrels: We machine our Barrels from either the best grade Chrome-Moly Vanadium Steel, or 416 Match Grade Stainless Steel. Our heavy profile Barrels (standard on most models) step down from 1" diam. at barrel nut to .750" at the sight base to improve heat dissipation and decrease barrel whip. The majority of our barrels are button rifled - right hand twist - 1 turn in 9", as we've found that the 1 in 9" twist gives optimum accuracy results with a broad range of ammunition, and will stabilize bullets up to 75 grains. DCM Competition Rifles are 1 in 8" twist for the very heavy bullets used in high power competition.

Chrome Lined Bore & Chamber:

A chromed bore and chamber - as in most of our Chrome Moly Steel Barrels - can double the barrel's life if proper care and regular maintenance procedures are observed. The chrome protects against corrosion, and as it is harder than the barrel steel, it reduces friction, increases velocity, and aids in chambering and ejection. Chrome lined barrels also clean up easier because lead, copper and powder fouling simply does not adhere as easily to the chrome lining - so you'll spend less time cleaning after a day at the range. Note: With any chrome lined barrel, you should avoid leaving ammonia based solvents, bore cleaners, or pastes in long term contact with the chrome lining (i.e. over-night soakings) as the ammonia can react with the chrome to cause oxidation. Regular session cleaning will ensure proper barrel care and long life. We apply a Manganese Phosphate finish to our barrels, and other critical steel parts, to protect against corrosion and rust and to produce a matte black, non-reflective surface color. We do not paint any of our parts. Finally, Bushmaster rifles and carbines are laser boresighted at the factory to assure that the accuracy inherent in our barrels works in coordination with the sights that we put on them.

The Bushmaster Varminter...



Varminter Specifications:

Caliber 5.56 mm / .223 Rem.
Overall Length 42.25 inches (107.3 cm)
Barrel Length 24" (60.9 cm)
Rifling R.H. twist; 1 turn in 9"
Weight w/o mag. 8.4 Lbs. (3.81 kg)
Operating Mode Gas Operated - Semi-Automatic

(Scope and Bipod not included.)

The Bushmaster Varminter is a varmint hunter's dream, and has been a runaway success since its 2001 introduction. Built around our superb DCM Competition Barrel, it includes all the options for the varmint specialist – such as...

24" Fluted Extra Heavy Varmint Barrel in 5.56mm / .223 Rem. caliber; 4150 chrome moly vanadium steel; full 1" diameter under the forend; 11° competition crowned muzzle; 1 in 9" twist for optimum performance with most varmint cartridges; full length fluting for increased cooling and reduced weight; machined to same tight specifications as our DCM Competition Barrel with tolerances twice as tight as our standard barrels. **Bushmaster Competition Trigger** - a smooth, two stage, 4 1/2 lb. pull helps focus the shooter's attention on the target. **V Match Vented Tubular Forend** which "free-floats" the barrel from the receiver forward and includes special cooling vents for increased barrel heat dissipation, and a bipod stud installed for easy mounting of most bipods. **Custom Rubberized Pistolgrip** in an ambidextrous, ergonomic design with a comfortable non-slip textured surface. **Bushmaster Modular Accessories System Mini-Risers** which add 1/2" height to scope mounting on the flat-top receiver for correct sight picture and comfortable "cheek-weld" on the stock. **Controlled Ejection Path** - shell ejection from the receiver has been modified so as to drop them all in the same place - a convenience for the reloader. **5 Round Magazine** - legal for hunting in most states. **Shipped in a Lockable Hard Case** - with "egg crate" foam padding for protection.

The Bushmaster Varminter... Available from your FFL Dealer **M.S.R.Price... \$1245.00** (PCWVMS 24FVAR9)

The Bushmaster Stainless Varmint Special...



Stainless Varmint Special Specifications:

Caliber 5.56 mm / .223 Rem.
Overall Length 42.25 inches (107.3 cm)
Barrel Length 24" (60.9 cm)
Rifling R.H. twist; 1 turn in 9"
Weight w/o mag. 8.84 Lbs. (4.01 kg)
Operating Mode Gas Operated - Semi-Automatic

(Shooting Rest not included.)

New in 2002, and building on the success of our first Varminter, the Stainless Varmint Special combines elements the serious varmint hunter would specify – including a polished, **416 Stainless Steel, 5.56mm/.223 Rem. Caliber 24" Barrel** - button rifled (1 in 9" right hand twist). This highly accurate barrel is free-floated in a **vented, tubular aluminum forend** and mated to our "flat-top" V Match Upper Receiver. The vented free-floater aluminum forend is supplied with a **Bipod/Sling Mount Stud** already installed. Two **Bushmaster Modular Accessories System Scope Riser Blocks** are mounted on the flat-top's Picatinny rail to raise your scope 1/2" for a proper sight picture. The lower receiver features a **Competition Two-Stage Trigger** and an **A2 Standard Buttstock** with buttplate storage compartment. An **Adjustable Palm Swell Tactical Pistol Grip** offers great shooting comfort and correct trigger pull angle. Bushmaster's "Stainless Varmint Special" ships complete with **Five Round Magazine**, and operator's manual in a **Bushmaster Lockable Gun Case**. Available through your FFL Dealer.

The Stainless Varmint Special... Available from your FFL Dealer. **M.S.R.Price... \$1245.00** (PCWVMS 24-9SS)

The Bushmaster 16" Bbl. Modular Carbine...

Free-Floater Four Rail Handguard • Fluted Lightweight Barrel • Skeleton Stock • Flip-up Sights

Bushmaster 16" Bbl. Modular Carbine
(PCWVML 16F) M.S.R.P... \$1650

Bushmaster's 16" Modular Carbine combines many of the new Bushmaster Modular Accessories. This unique carbine is designed around an A3 type "flat-top" Upper and has a 16" Chrome Lined Chrome Moly Steel fluted barrel with a milled gas block. It includes the "Skeleton Stock" – featuring a comfortable rubber buttplate and a quick detach sling swivel mount that can be positioned to either the left or right side of the carbine. A neoprene foam sleeve covers the buffer tube to provide a comfortable cheek weld and deaden the operational sounds of the buffer/action spring.

A Bushmaster Modular Accessories System (B.M.A.S.) Four Rail Free-Floater Tubular Forend combined with the A3 type "flat-top" Upper Receiver provide all the Picatinny rails necessary for mounting a variety of sight, scopes or accessories. "Free-floating" the barrel (from the barrel nut forward) avoids any possibility of barrel deflection or accuracy degradation. Molded Rubber Rail Sure Grips snap over the rail sections on the handguard to add comfort and rail protection. The dual aperture B.M.A.S. rear flip-up sight is a detachable unit with a windage knob calibrated to 1/2 Minute of Adjustment. The B.M.A.S. front flip-up sight clamps around the milled front gas block. It folds down with the touch of a button to allow scope use and incorporates an elevation adjustable M16A2 front sight post. The ergonomically contoured Pistol Grip is an ambidextrous design molded of urethane with a stipple finish to provide a solid non-slip grip. Bushmaster's Modular Carbine – available only through FFL dealers – is shipped with 10 Round Magazine, Operating and Safety Instruction Manual, and a Black Web Sling in a Bushmaster lockable, foam lined carrying case.



Specifications:

Caliber 5.56mm / .223 Rem.
Overall Length 34.5" [87.63 cm]
Barrel Length 16" [40.64 cm]
Rifling 1 turn in 9" R.H. twist
Weight w/o mag. 7.3 lbs. [3.31 kg]
Mode of Operation Gas Operated - Semi-Automatic

All Bushmaster Modular Accessory System (B.M.A.S.) parts are available as accessory additions for your rifle.
See the B.M.A.S. Section of this catalog (Pgs. 70 – 73) for complete descriptions and photos.

Bushmaster – The Best by a Long Shot! Here's why...

Receiver Features: Our Receivers are either high tensile strength 7075T6 aircraft quality aluminum forgings (not castings which can contain flaws and/or air bubbles), or injection molded Carbon 15 composite. Bushmaster Upper and Lower Receivers fit tightly with two "captivated" push pins (which can't fall out and become lost). No-tools are needed for field take down. Receivers incorporate a brass deflector for ejected shell control, and a raised area around the magazine catch button (to prevent accidental magazine release). For long wear in the upper receiver, we apply a baked dry-lube film, and for protection against corrosion, the receivers are Hard Anodize finished, with a Nickel Acetate final seal coat.

Handguards, Buttstock and Pistol Grip: Our handguards are molded of black thermoplastic (carbine length) or fiberglass (full length) respectively, and include aluminum heat shields to dissipate barrel heat. Pistol grips are molded of the same material, and have a finger groove, checkered side panels and a serrated back for ergonomic comfort and a solid, non-slip grasp. On standard models, the A2 style Buttstock is fitted (5/8" longer than the original A1 version, with a trigger pull of 13.5 inches), and it includes a trapdoor storage compartment for a cleaning kit or small parts. Our new BATF approved, fixed length "Tele-Style" stock offers the military look of the original collapsible carbine telescopic. Both stocks include sling loops.

Front & Rear Sights: Bushmaster uses only steel forgings for the front sight base - far superior to castings in tensile strength. We use the standard M16A2 Dual Aperture Rear Sight. It features adjusting knobs for windage and elevation - eliminating the need for a sight tool (as with the A1 sight). The beauty of the dual aperture flip-up is that the same sight can offer both quick target acquisition (field aperture) and fine distance sight picture (with the target aperture). Windage adjustment is 1/2 inch incremental at 100 yards instead of the older version which offered only 1 inch increments. Elevation increments are 1 Minute of Adjustment on our standard A2 sight, and 1/2 M.o.A. on our A3 Type Removable Carry Handle. On the DCM Competition Rifle you can order a 1/4 M.o.A. rear sight.

Bushmaster M4 Type 16" Post-Ban Carbine...

M4 Profile Barrel • Mini Y Comp Muzzle Brake • Fixed length BATF Approved Tele-style Stock

Mini Y-Comp
Muzzle Brake

M4A2 Type Post-Ban Carbine

BATF Approved,
Fixed Position, Tele-Style
Buttstock

M4A3 Type
Post-Ban Carbine
includes A3
Removable Carry Handle
as shown at right

A very popular model since its introduction in 2001, the Bushmaster XM15 E2S M4 Type Post-Ban Carbine features a lightweight 14.5" Barrel machined in the distinctive M4 profile with a permanently attached Mini Y Comp muzzle brake. This configuration yields a total barrel length of 16" to comply with Post-Ban regulations. A BATF approved, fixed length tele-style buttstock is added to complete the military look of this versatile carbine. Per BATF requirement, it is pinned and fixed in an "open" position (i.e., its length cannot be changed).

The barrel is chrome lined in both bore and chamber for maximum longevity and ease of maintenance, and the button rifling, in a 1 x 9" right hand twist, will stabilize a wide range of currently available ammunition with bullet weights up to 75 grains. On the A2 Type, the M16A2 dual aperture, rear sight system offers both windage and elevation adjustments. Elevation is calibrated from 300 to 800 meters. The dual aperture flip-up rear sight offers a short range, quick target acquisition sight picture, or a smaller diameter opening for long distance accuracy.

The A3 Type Carbine includes our Removable Carry Handle (see inset photo) with 1/2 Minute of Adjustment Rear Sight - calibrated from 300 to 600 meters. The handle clamps onto the Upper Receiver's full length Picatinny rail which will accept an wide array of scopes, red dot sights, accessories, and night vision equipment.

As with all other Bushmasters, the forged 7075T6 aircraft quality aluminum receivers are finished in a non-reflective mil. spec. hard anodize for durability, and include all M16A2 design improvements such as cartridge case deflector, last round bolt hold-open and raised ribs for magazine release button protection. The safety selector has position markers on both sides of the receiver for an extra margin of safety. A manganese phosphate coating insures complete protection against corrosion or rust on barrel and other exposed steel parts. The M4 Type 16" Carbine - available only through your FFL Dealer - is shipped in a lockable, hard plastic case complete with 10 round magazine, carrying sling, and Operator's Safety and Instruction Manual.

Specifications:

Caliber	5.56 mm / .223 Rem.
Mag. Capacity	Shipped with 10 round (accepts all M16 type)
Overall Length	34.875 inches (88.6 cm)
Barrel Length	16.5" total w. Mini Y Comp (40.6 cm)
Rifling	R.H. twist; 1 turn in 9"
Weight w/o magazine	A2 Type - 6.59 Lbs. (2.99 kg)
Mode of Operation	Gas Operated - Semi-Automatic

- M4A2 Type Post-Ban Carbine (PCWA2X 14M4MY) M.S.R.Price... \$1065.00
- M4A3 Type Post-Ban Carbine (PCWA3X 14M4MY) M.S.R.Price... \$1165.00



Bushmaster Rifles are shipped in a lockable, foam lined, hard plastic carrying case. ... \$16.95 Value

Bushmaster's M4 Type Carbine is available in kit form - including all parts except the stripped lower.

Many options are available - consult with your Bushmaster salesperson. Stripped Lower must be purchased from an FFL Dealer.

Bushmaster - The Best by a Long Shot! Here's why...

.223 Remington or 5.56mm... We've had numerous inquiries about .223 Rem. versus 5.56mm NATO ammunition. **The short answer is that all Bushmaster barrels are chambered for the 5.56mm cartridge.** Most of our barrels are stamped 5.56 NATO - usually just ahead of the front sight. Despite the fact that our Lower Receivers are stamped CAL.223-5.56MM, our chambers, barrels, and bolts are designed to withstand the higher pressures of the 5.56mm cartridge. We do this for the safety of our customers, and because our rifles have always been built following the military pattern. **In any of our barrels, the .223 Remington cartridge can be fired safely.**

So, what's the difference between the two cartridges? They have basically the same exterior dimensions and length, but the 5.56 is usually loaded to produce higher velocity and chamber pressures. It has thicker case walls for the extra strength needed to handle those higher pressures. The difference comes in the chambering of the rifle, and that difference is in "Leade" (more commonly known as the throat) which is the portion of the barrel directly in front of the chamber where the rifling has been removed to allow room for the seated bullet. In a 5.56mm chamber the throat is typically .162" - in a .223 chamber it's usually .085" (about half that dimension). The result of firing a .223 cartridge in the Bushmaster 5.56mm chamber is a slight loss of velocity when measured against the 5.56mm cartridge. **However, if you own other (non Bushmaster) rifles specifically chambered for the .223 Remington, you should not use 5.56mm ammunition in them as it is considered by SAAMI (Small Arm and Ammunition Manufacturers Institute) to be an unsafe ammunition combination*.**

*This 5.56mm/.223 Rem. information from Bushmaster Gunsmithing and the Winchester Law Enforcement Ammunition Website.



Bushmaster SuperLight Carbines...

Slim Profile Barrels with either the BATF approved Tele-style Stock or "Stubby Stock"

A3 Type Carbines include the A3 Removable Carry Handle

A3 Type SuperLight Carbine with Fixed Tele-style Stock



Caliber: 5.56mm / .223 Rem.
Overall Length - Tele-Style: 34.5"
Overall Length - Stubby-Style: 31.25"
Barrel Length: 16"

Weight w/o magazine...
SuperLight with Tele-Style: 6.25 lbs.
SuperLight with Stubby: 5.80 lbs.
Gas Operated - Semi-Automatic

- SuperLight A2 Type Carbine with Fixed Tele-style Stock (PCWA2X 16SL) Suggested Retail Price... \$1010.00
- SuperLight A3 Type Carbine with Fixed Tele-style Stock (PCWA3X 16SL) Suggested Retail Price... \$1110.00
- SuperLight A2 Type Carbine with Stubby Stock (PCWA2Y 16SL) Suggested Retail Price... \$985.00
- SuperLight A3 Type Carbine with Stubby Stock (PCWA3Y 16SL) Suggested Retail Price... \$1085.00

These Bushmaster lightweights feature the Chrome Lined SuperLight 16" Barrel (turned from .670" to .565" diameter under the handguard, .625" diameter under the sight base, and .570" diameter out to the muzzle; button rifled 1 turn in 9", right hand twist, with six lands and grooves). This slim profile barrel, in combination with either the permanently Fixed Tele-style Stock or the short "Stubby" Stock make a sweet handling, easy to shoot carbine. They are available in either A2 type (Fixed Carry Handle and Stubby Stock shown above) or A3 Type with Removable Carry Handle (shown above top with Tele-style stock). The Stubby Style buttstock - designed originally for body armored Law Enforcement officer use - is 3.25" shorter and .47 lbs. lighter than the Fixed Tele-Style stock. Bushmaster SuperLight Carbines are shipped in foam lined, lockable hard cases complete with with Black Web Sling, 10 Round Magazine, Operating and Safety Instruction Manual. Available only through FFL Dealers, and Law Enforcement models in Pre-Ban configurations (with bayonet lug and flash suppressor) can be ordered by Departments and Gov't. agencies.

Bushmaster Dissipator Carbines...

16" Barrel with Full Length Forend and Special Gas Block Placement

A3 Type Dissipator Carbine includes A3 Removable Carry Handle



Caliber: 5.56 mm
.223 Remington
Overall Length
34.5 inches
Weight w/o mag
(A2 Type) 7.69 lbs.
Gas Operated -
Semi-Automatic

- Dissipator A3 Type 16" Bbl. Carbine (PCWA3S 16D) M.S.R.Price... \$1095.00
- Dissipator A2 Type 16" Bbl. Carbine (PCWA2S 16D) M.S.R.Price... \$995.00

This versatile carbine is unique in the Bushmaster XM15 family in that it's operating system gas block is located behind the front sight base and under the rifle length handguards, and the rifle length placement of the front sight allows for optimal use of the full sight radius designed into the M16A2 adjustable sight system. The 16" heavy profile barrel - chrome lined in both bore and chamber - offers excellent accuracy and long life. Forged aluminum receivers, standard A2 "trapdoor" buttstock, forged steel front sight base, and black composite plastic pistol grip are all standard features of the Dissipator models. They are available to law enforcement officials and governments in Pre-Ban / L.E. configurations (with bayonet lug, telescoping buttstocks and flash suppressor). Barrel Fluting is an available option at \$50.00 extra. The XM15 E2S Dissipator Carbine is shipped in a lockable, plastic carrying case with a 10 round magazine, Operator's Safety and Instruction Manual and Black Web Sling - available only through your FFL Dealer.

Bushmaster SuperLight and Dissipator Carbines are available in kit form including all parts except the stripped lower. Many options are available - consult with your Bushmaster salesperson. Stripped Lowers must be purchased from an FFL Dealer.

Bushmaster XM15 E2S 16" Barreled Carbines...

A3 Type Carbine
includes A3 Removable
Carry Handle



**Specifications:
XM15 E2S 16" Bbl.
A2 Type Carbine**

Caliber 5.56 mm / .223 Rem.
Magazine 10 rounds
Overall Length 34.5 inches (87.63 cm)
Barrel Length 16" total (40.64 cm)
Rifling R.H. twist; 1 turn in 9"
Weight w/o magazine 7.16 Lbs. (3.25 kg)
Mode of Operation Gas Operated -
Semi-Automatic

These Bushmaster Carbines offer light weight, compact size, balanced swing weight, and great accuracy from their chrome lined, Chrome Moly steel barrels (16" length above and 14.5" Bbl. length in the AK Carbines below). With permanently attached AK type muzzle brakes, the AK Carbines have an overall barrel length of 17", making them BATF legal Post-Ban models (BATF considers barrel and muzzle brake to be an integral unit). A2 solid buttstocks, Bushmaster forged aluminum receivers and carbine length "shorty" handguards round out the features of these versatile carbines.

The M16A2 sight system is fitted - featuring dual aperture rear sights (windage adjustable to 1/2 M.o.A. and 1 M.o.A. for elevation, with a 300 - 800 meter range). In the A3 Type carbines, the Removable Carry Handle (included) has a rear sight graduated from 300 to 600 meters, but of finer thread pitch to yield 1/2 Minute Adjustments. Front sights are all of the elevation adjustable A2 front post type. The Picatinny Rail on the Upper Receiver of the A3 Type Carbines allows versatile attachment of a variety of sights, scopes or night vision optics. Optional fluted barrels are available at \$50 extra.

Bushmaster's XM15 E2S Carbines (available only through FFL Dealers) include 10 Round Magazine, Operators Safety and Instruction Manual, and Black Web Sling - all shipped in our lockable, Bushmaster hardsided carrying case.

For Law Enforcement applications, these models are available to law enforcement officials and governments in Pre-Ban configurations (with bayonet lug, flash suppressor and telescoping stocks).

Bushmaster XM15 E2S "AK" Carbines...

A3 Type AK Carbine
includes A3
Removable Carry Handle

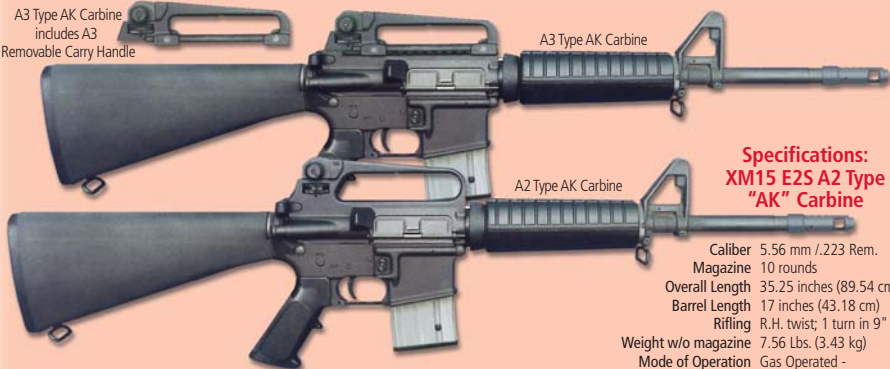

**Specifications:
XM15 E2S A2 Type
"AK" Carbine**

Caliber 5.56 mm / .223 Rem.
Magazine 10 rounds
Overall Length 35.25 inches (89.54 cm)
Barrel Length 17 inches (43.18 cm)
Rifling R.H. twist; 1 turn in 9"
Weight w/o magazine 7.56 Lbs. (3.43 kg)
Mode of Operation Gas Operated -
Semi-Automatic

- 16" Bbl. Carbine A3 Type (PCWA3S 16) Mfg. Suggested Price... \$1085.00
- 16" Bbl. Carbine A2 Type (PCWA2S 16) Mfg. Suggested Price... \$985.00
- AK Carbine A3 Type (PCWA3S 14AK) Mfg. Suggested Price... \$1105.00
- AK Carbine A2 Type (PCWA2S 14AK) Mfg. Suggested Price... \$1005.00



Tele-Style Stocks available... Ask about ordering your Bushmaster carbine with this popular BATF approved, Post-Ban legal, fixed length stock. ...\$25.00 Additional

Post-Ban Muzzle Brakes available:

Izzy Brake
(IZ-102660-PSTF)
\$25.95

Mini Y COMP
(YHM-259P)
\$29.95

AK Muzzle Brake
(MMT-001ZPB)
\$25.95



See Page 37 - Muzzle Brakes/Suppressors.

These Bushmaster Carbines are available in kit form - including all parts except the stripped lower.

Many options are available - consult with your Bushmaster salesperson. Stripped Lower must be purchased from an FFL Dealer.

Bushmaster Target Model Rifles...

available with Chrome Lined, Chrome Moly Steel Barrels or Stainless Steel Barrels...

A3 Type Removable Carry Handle is included with A3 Model Rifles.

A3 Type 20" Barrel Target Rifle

A2 Type 20" Barrel Target Rifle

A3 Type 20" Stainless Barrel Target Rifle

A2 Type 20" Stainless Barrel Rifle

Bushmaster A2 / A3 Type Target Rifles are available through your FFL Dealer.
Shipped with 10 Round Magazine, Sling and Operator's Manual in a Lockable Hard Case.

SPECIFICATIONS:

XM15 E2S - 20" Bbl. RIFLE

Caliber 5.56 mm / .223 Rem.
Mag. Capacity 10 rd. (accepts all M16 type)
Overall Length 38.25 inches (97 cm)
Barrel Length 20 inches (51 cm)
Rifling R.H.; 1 turn in 9" [22.8 cm]
Weight w/o mag. 8.2 Lbs. (3.72 kg)
Mode of Operation Gas Operated - Semi-Automatic

- **A3 20" Chrome Lined Bbl. Target Rifle** (PCWA3S 20) **M.S.R.Price... \$1095.00**
- **A2 20" Chrome Lined Bbl. Target Rifle** (PCWA2S 20) **M.S.R.Price... \$995.00**
- **A3 20" Stainless Bbl. Target Rifle** (PCWA3S 20SS) **M.S.R.Price... \$1155.00**
- **A2 20" Stainless Bbl. Target Rifle** (PCWA2S 20SS) **M.S.R.Price... \$1055.00**
- **A3 24" Chrome Lined Bbl. Target Rifle** (PCWA3S 24) **M.S.R.Price... \$1105.00**
- **A2 24" Chrome Lined Bbl. Target Rifle** (PCWA2S 24) **M.S.R.Price... \$1005.00**
- **A3 24" Stainless Bbl. Target Rifle** (PCWA3S 24SS) **M.S.R.Price... \$1165.00**
- **A2 24" Stainless Bbl. Target Rifle** (PCWA2S 24SS) **M.S.R.Price... \$1065.00**

The Target Models qualify as the "standards" of our line, and in 2002, Bushmaster introduced Stainless Steel Barrels to these fine rifles. Both A2 and A3 type rifles feature heavy profile match grade barrels machined from either Chrome Lined Chrome Moly Steel or Polished 416 Stainless Steel. They are button rifled (1 in 9", R.H. twist) to stabilize a wide range of popular bullet weights and available in 20" or 24" barrel lengths.

The A2 Type Rifle's Upper Receiver features the fixed carrying handle design of the standard military rifle with an integral rear sight. Knobs adjust the sight for windage and elevation. The A3 Type uses an Upper Receiver created from a different forging - incorporating a Picatinny rail on the top of the receiver. Often called a "flat-top", this upper receiver's mounting rail allows easy attachment of accessory scopes, sights, and optic devices. With the A3 Type Rifle, a removable carry handle is included, and the dual aperture rear sight in that handle has 1/2 Minute of Adjustment gradations in elevation and windage. The handle is machined from an aircraft aluminum forging, hard anodize finished, and includes two thumbscrews which clamp it onto the rail in seconds with no loss of zero.

Note: Complete Rifles are available to law enforcement officials and governments in Pre-Ban configurations (with bayonet lug, flash suppressor and telescoping stocks).

Bushmaster Target Rifles are shipped in a lockable, clamshell type hard case - complete with 10 Round Magazine, Operating and Safety Instruction Manual, and a Black Web Sling.

...a \$16.95 Value



Post-Ban Muzzle Brakes available:

Izzy Brake
(IZ-102660-PSTF)
\$25.95

Mini Y COMP
(YHM-259P)
\$29.95

AK Muzzle Brake
(MMT-0012PB)
\$25.95



See Page 37 - Muzzle Brakes/Suppressors.

Ask your salesperson about Bushmaster Rifle Kits - which include all parts except the stripped lower.
Many options are available - consult with your Bushmaster salesperson. Stripped Lower must be purchased from an FFL Dealer.

Bushmaster V Match Rifle & Carbine...

The V Match flat-top Upper Receiver and "free-floater" handguard make these models a great choice for the competitive shooter or the varmint hunter. Heavy profile, match grade, chrome-moly vanadium steel, chrome lined barrels consistently deliver match winning accuracy. Barrel lengths of 16", 20" or 24" are available, and the barrel, and other steel components, are manganese phosphate coated for complete protection against exterior corrosion or rust. The forged 7075T6 aircraft aluminum receivers incorporate all M16A2 design improvements. The Upper Receiver's precision machined Picatinny type rail allows mounting of a wide variety of scopes, sights and optics, and the tubular aluminum V Match knurled handguard lets the barrel "free float" for optimum accuracy. The handguard is black hard anodize finished and machine checkered for optimum control and a non-slip grip. Though we show the front sling loop mounted to the sight base (our normal manufacturing procedure), if you competitively shoot with a sling, we recommend the addition of our optional sling stud so as not to deflect the free floating barrel in any way. Our front sight bases are available in either the "full sight" version (see inset below) or a milled off "no sight" version (shown) for those using scopes or other sights. The XM15 E2S V Match Rifles and Carbines are shipped complete with 10 round magazine, instructional manual, sling and carrying case.

Note: Complete Weapons are available to law enforcement officials and governments in Pre-Ban configurations (with bayonet lug, flash suppressor and telescoping stocks).



V Match 20" Barrel Rifle

V Match 16" Carbine

When ordering V Match rifles or carbines, please specify either the full front sight and base (right), or the "milled" base (as shown in photos above). Also, see our Barrel Parts Section for a variety of optional factory installed muzzle brakes.

All Bushmaster Rifles and Carbines are shipped in a hard plastic, lockable case...
A \$16.95 value!



SPECIFICATIONS:
V MATCH 20" Bbl. RIFLE

Caliber	5.56 mm / .223 Rem.
Magazine Capacity	10 rd. (accepts all M16 type)
Overall Length	38.25 inches (97 cm)
Barrel Length	20 inches (51 cm)
Rifling	R.H. twist; 1 turn in 9"
Weight w/o magazine	7.99 Lbs. (3.62 kg)
Mode of Operation	Gas Operated - Semi-Automatic



Bushmaster's A3 Type Removable Carry Handle is an optional extra for V Match models. It features a 1/2 Minute of Adjustment Rear Sight. (Part # 9349063-9) **\$99.95**

Bushmaster V MATCH Rifle and Carbine Models... Shipped with 10 Rd. Magazine, Sling and Operator's Manual in Lockable Hard Case. **Barrel Fluting is available - \$50.00 extra**

- 16" Bbl. Carbine (PCWVMS 16) M.S.R.Price... \$1045.00
- 20" Bbl. Rifle (PCWVMS 20AH) M.S.R.Price... \$1055.00
- 24" Bbl. Rifle (PCWVMS 24AH) M.S.R.Price... \$1065.00

Bushmaster Modular Accessories System Flip-Up Front Sight for V Match Models...

\$99.95 (YHM-9360K) Slips over milled front sight bases and clamps around barrel. Locks up or down with the push of a button - use with flip-up style rear sights or the A3 Removable Carry Handle.

See Pages 70 - 73 for the complete Bushmaster Modular Accessories System.



Ask your salesperson about Bushmaster V Match Rifle Kits. They include all parts except the stripped lower.

The Bushmaster DCM Competition Rifle... With the exception of custom engraving, this is the same rifle selected for Club Sales by the Civilian Marksmanship Program, and used successfully in N.R.A. sanctioned High Power Competition Matches all around the country.



The Bushmaster DCM Competition Rifle...

Ready for National High Power Competition - Right out of the box!

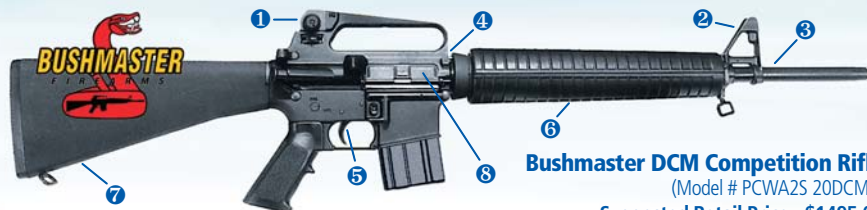

Bushmaster DCM Competition Rifle

(Model # PCWA2S 20DCM8)

Suggested Retail Price - \$1495.00

(Must be purchased through an FFL Dealer)



The 600 Yard Range at Camp Perry -- Home of the National High Power Matches and "Birthplace" of the Bushmaster DCM Rifle.

Bushmaster Firearms has designed a rifle for the serious DCM Competition shooter. In keeping with DCM Competition rules, this rifle looks like a stock "AR15" type rifle but includes competition modifications that will give you the winning edge – right out of the box.

This highly accurized rifle features:

① An A2 Rear Sight specially modified to accept interchangeable "micro-aperture" peeps. Its windage and elevation mechanisms feature either 1/2 or 1/4 Minute Adjustments with each click of the windage knob or elevation dial. Precision machined micro-aperture inserts are available in four sizes: .036" - .040" (standard, and most commonly selected by competition shooters) - .046" and .052" sizes. **Please specify when ordering.**

② A Competition Front Sight Post specially ground on three sides for optimum visual clarity - available in your choice of two different widths (.052" or .062" width. **Please specify when ordering.**) This post is secured within the front sight base by a set screw to avoid the possibility of any movement once you have established your zero.

③ A 20" Bushmaster Extra Heavy Competition Barrel - a full 1" in diameter under the handguard - with an 11° crowned competition muzzle. Precision button rifled in a 1 x 8" right hand twist, they are machined from Chrome-Moly Vanadium barrel steel, lapped and hardened to Rockwell C26 to 32 - superior to stainless barrels! The chamber is machined to SAAMI specifications. **Note: These barrels are shipped well oiled. For your safety, they should be thoroughly cleaned before shooting. Follow all break-in & maintenance instructions included with your rifle.**

④ In the Upper Receiver, the Bolt is matched to the Barrel Extension for positive lockup and optimum accuracy.

⑤ The Lower Receiver houses a finely honed Competition Trigger that is factory set for a DCM legal 4.5 lb. pull. The 1st Stage is 3.5 lbs., and the letoff (2nd Stage) is 1 lb.

⑥ The forearm uses stock style outer handguards over a "free floater" tube that does not contact the barrel. A sling swivel is attached to the leading edge of the tube so as to avoid any possibility of barrel deflection when using a sling.

⑦ The buttstock has been improved for competition with the addition of a 3.62 lb. lead counterbalancing weight which can be trimmed by the competitor to achieve proper balance, and adds to the solid feel of this special competition model. The overall weight of the rifle totals 13.5 pounds.

⑧ "Controlled Ejection Path" - Ejection of spent cases from the receiver has been engineered so as to drop them all in the same place - a great convenience for the reloader, and a courtesy to fellow competitors next to you on the line.

Any of the accurizing parts built into the Bushmaster DCM Rifle can be ordered as accessory additions for your rifle. For more information, call or go online to: www.bushmaster.com or consult us by email: Sales@bushmaster.com

Bushmaster DCM Competition Rifle Package...

(Model # PCWA2S 20DCM8)



The Bushmaster DCM Rifle...

As described in detail on the previous page, the DCM ships complete with two 10 Rd.

Magazines; a Chamber Checker Safety Device; Web Sling; Operating and Safety Instruction Manual; and Maintenance Instructions that are specific to the DCM Rifle and its unique barrel - all shipped in Bushmaster's lockable foam-lined carrying case.

Bushmaster DCM Rifle Package must be purchased through an FFL Dealer... Suggested Retail Price - \$1495.00

Bushmaster DCM Competition Upper Receiver/Barrel Assembly... Snap this Upper/Barrel

Assembly on your lower and you're ready to win!

Includes: • **Extra Heavy Competition Barrel** (full 1" diameter under the handguard) with Bolt matched to the barrel extension at factory.

• **Competition Front & Rear Sight System...** Specify: Your choice of 1/2 or 1/4 Minute of Adjustment Sight; one of 4 Micro-Apertures and one of 2 Competition Front Post Widths (see next page).

• **Free-Floater Competition Handguard** (hand-guard tube / barrel nut combination) with sling loop.

• **Bushmaster Upper Receiver...** complete with bolt, carrier and charging handle - all headspaced and test-fired at the factory. **DCM barrels must be cleaned thoroughly before firing - follow all break-in instructions.**

DCM Competition Upper Receiver/Barrel Assembly... \$765.00 (PURA2B 20CG8)

DCM Competition A2 Upper Receiver Assembly with A2 Competition Rear Sight...

Includes forward assist assembly, ejection port cover assembly and one competition sight Micro-Aperture in your choice of four "peep" sizes - please specify (see descriptions next page).

- **DCM Competition A2 Upper Receiver with 1/2 Minute Rear Sight... \$209.95** (Part # A2URCG2)
- **DCM Competition A2 Upper Receiver with 1/4 Minute Rear Sight... \$209.95** (Part # A2URCG4)



DCM Competition Lower Receiver Assemblies...

All Include our DCM Two-Stage Competition Trigger...

• Complete DCM Lower Assembly...

Bushmaster DCM Lower Receiver with A2 Buttstock, Competition Buttstock Weight, Pistol Grip and Two Stage Trigger (shown at right). (Part# A LOW STD W/CGWT)

Suggested Retail Price (avail. only through FFL dealers) - **\$415.00**

• **DCM Lower Assembly...** Same assembly above less Buttstock Weight.

Suggested Retail Price - \$390.00 (Part# A LOW STD W/CG)

• **DCM Lower Receiver Assembly minus Buttstock...**

Includes Pistol Grip and DCM Two Stage Trigger.

Suggested Retail Price - \$315.00 (Part# ALOW W/OSTK W/CG)



Bushmaster Competition A2 Rear Sight Assembly... Bushmaster offers these super-accurate Rear Sight Assemblies - and individual parts for them - to the serious competition shooter. The elevation and windage mechanisms on these fine sights feature either 1/2 or 1/4 Minute of Adjustment with each click of the windage knob or elevation dial. The long distance aperture has been machined to allow screw-in installation of one of four different interchangeable Micro-Apertures (one aperture of your choice is included with each complete sight or flip-up assembly). These precision machined flip sight inserts are available in four aperture sizes measuring: .036" / .040" (Standard - 9 out of 10 shooters find the .040" standard aperture works best, your eyes may differ) / .046" or .052"



- 1/2 M.o.A. Rear Sight (with choice of aperture size). \$114.95 (9349072CGA2)
- 1/4 M.o.A. Rear Sight (with choice of aperture size). \$114.95 (9349072CGA4)

Bushmaster DCM 1/4 Minute Windage Competition Rear Sight Conversion Kit... \$19.95 (ar 1/4min convk) Convert your old A2 sight to 1/4 Minute of Adjustment windage configuration with these competition parts. Kit includes 1/4 M.o.A. drum, pin, detent springs and balls.

A2 Competition Front Sight Post... \$12.95

A quality sight post that is surface ground on three sides for optimum visual clarity - easily replaces your existing sight post.

Available in 2 widths - Specify...

.052" (9349056CG52) / .062" (9349056CG62)



A2 Competition "FLIP" Sight... \$24.95

with one micro-aperture...

- Choose: .036" (CGF36);
 - .040" (std.) (CGF40);
 - .046" (CGF46);
 - or .052" (CGF52)
- aperture sizes.



"The Hood"... (9349075CGH) \$14.95 A Competition Rear Sight Shroud, (shown center in photo) this tubular, threaded insert for our competition flip-up eliminates all glare and improves your sight picture. Internally threaded for the micro-aperture of your choice.

"The HOOD KIT"... \$37.95

Includes our Competition Flip-up; the "Hood" Sight Shroud and your choice of one Competition Aperture (sizes at right). Part numbers below indicate the size of the aperture opening. **Choose from...**

CGF36HK / CGF40HK / CGF46HK / CGF52HK



Extra Competition Sight Apertures*... \$9.95 ea.

Choose from: .036" (CGI36) / .040" (Std.) (CGI40) / .046" (CGI46) / .052" (CGI52). These thread directly into the flip-up in your Competition Sight. Your vision determines which micro-aperture suits you best (most shooters prefer the .040" standard).

***Any Three Apertures can be purchased as a set - \$24.95** Select from sizes above.



Bushmaster Two Stage Competition Trigger... For the Serious High Power Competitor... \$119.95 (8448592-SCGK) This finely honed competition trigger includes all the specially modified parts shown plus instructions - ready for installation in your lower receiver. This trigger can be set for a 3 1/2 lb. DCM legal 1st Stage and a 1 lb. (2nd Stage) letoff. **NOTE: This Trigger will not fit in Colt Lowers with "Block" over Safety and is not designed to work with large Colt pivot pins.**

Also Available... Two Stage Competition Trigger with an Ambidextrous Safety... \$139.95 (8448592-SCGKA)

Bushmaster DCM "Free-Floater" Kit... A Barrel Nut / Free-Floater Tube / Handguard Combination:

(9349059CGA) \$149.95 Designed to meet all DCM regulations, this competition forend allows the barrel to free float from the barrel nut forward for maximum accuracy. A sling swivel loop is mounted to the bottom-front of the tube, and the delta ring, weld spring, snap ring and a special gas tube are all included in this kit.



DCM Free-Floater Tube & Custom Gas Tube set...\$124.95 (2698823) (Standard handguards require minor modification to fit.)



Bushmaster DCM Competition Heavy Barrel with Factory Matched Bolt and Front Sight Base... \$295.95 (9349054-20CGA)

This lapped 20" Barrel, button rifled in 1 x 8 twist, features an 11° competition type muzzle crown and SAAMI Spec. chamber. Machined from finest Chrome-Moly Vanadium Steel with a Manganese Phosphate finish, it is a full 1" diameter from the barrel extension forward to the sight base step. **These parts require gunsmithing assembly.**

We recommend assembly by an experienced AR15 gunsmith to bring out the accuracy designed into this extra heavy competition barrel.

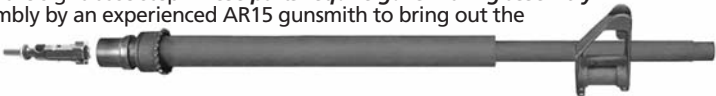

A2 Buttstock Balance Weight... \$19.95

(9349119SW) Fits snugly in the standard A2 buttstock compartment without rattle - a 3.62 lb. chunk of lead that can be trimmed to help achieve a perfectly balanced rifle. Its wedge shape and rubber pressure pad ensure a tight, rattle-free fit.



Competition Handguard Balance Weight...

\$29.95 (GPSS-HBW) This lead balancing weight fits inside the bottom half of the standard A2 handguard to add forend weight to your competition rifle (a companion to the buttstock weight above). Weighs approx. 3.5 lbs., it can be cut down for perfect balance. (Handguard half is shown for reference only - not included.)

Top Loading Single-Shot Magazine Follower...

\$12.95 (SS-FOL) A blue plastic follower that installs in seconds inside either Pre- or Post-Ban magazines. It allows single shot loading of extra heavy bullet competition handloads that won't function in regular magazines. (Shown separate and installed - magazine not included.)



AR15 Bolt Release Extention...

\$44.95 (SSP-1) A finely machined aluminum lever to help High Power Competitors get back on target faster by keeping the forearm hand in place. After inserting a fresh mag, simply push the lever with the trigger finger to snap the bolt forward - no more reaching over the rifle. It slips over the bolt catch release, and locks in place with supplied set screw and Allen wrench.



Moly-Slide™ Lubricating Paste...

\$7.95 (MS-100) Works great on competition triggers! A 60% Molybdenum Disulfide (MoS2) lubricating paste for wear resistance, anti-seizing and anti-galling on cams, bushings, press fit assemblies, and other sliding surfaces. Moly-Slide™ has a very wide working temperature range with minimal evaporative loss. The 1 oz. jar will usually last the average shooter/gunsmith for years - a little Moly-Slide™ goes a long way!

AR15/M16 Lower Receiver Safety Block...

\$6.95 (SB16) This bright yellow safety block locks into the magazine well when the bolt is retracted and indicates a safe weapon. We use them regularly here at the Bushmaster factory!



Lower Receiver Safety Block with Flag...

\$7.95 (SB16F) Similar to the safety block above, this improved model adds a safety flag that shows out of the open ejection port. A competition and range safety must!



Chamber Checker Safety Flag... \$1.95

(CC Chamber Check)

This tough yellow plastic flag slips into the chamber. Close the bolt on it, and it clearly shows your rifle's range-safe status (shown separately, and installed, above).

Turner Saddlery AWS Competition Sling...



\$69.95 (TS-NMSRS)

A high quality sling designed for use with the DCM High Power Competition rifle, it is made of a new all weather synthetic (AWS) material that requires no "break-in" and will not stretch. These are custom stamped with our Bushmaster logo. Black - 54-56" length - approved for use by CMP and NRA.

Bushmaster Sighting-in Targets...

\$2.95

(QP-015K)

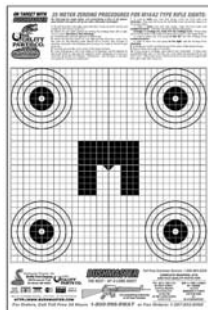

One Dozen 25 meter sighting-in targets with full instructions to help you get your rifle zeroed in right. Packaged in a plastic bag.

UVEX Sharp-Shooter Safety Eyewear - Includes Free Earplugs... These tough, sporty, and lightweight Uvex Shooting Glasses protect both your eyes and your ears! - they come with free earplugs. Polycarbonate uni-lens blocks 99.9% of harmful ultraviolet radiation from the sun, and is "Ultradura" hardcoated to guard against abrasion and scratching. They're tough enough to meet ANSI Z87.1-1989 and OSHA guidelines, and their wrap-around design provides excellent peripheral vision. Black polycarbonate frames feature adjustments for temple length and tilt for a custom fit. Each pair of Uvex glasses includes shooters earplugs warranted to reduce noise by 30 decibels (ANSI test S3.19-1974). Three different lens colors available: clear; amber, and espresso. Great eye and ear protection at a great price!



**UVEX Sharp-Shooter Safety Eyewear
Includes Free Earplugs...**

Clear Lens... \$11.95 (R-03511)

Amber Lens... \$11.95 (R-03512)

Espresso Lens... \$11.95 (R-03513)

Sindair International Sight and Muzzle Cover Set...

\$11.95 (14-200)



Popular protective covers often seen on the DCM ready line, these are molded from bright yellow vinyl to protect "sight zero" and to keep dirt out the muzzle. The set includes front and rear covers and two sizes of muzzle guards - one for Pre-bans with flash suppressor, another for Post-bans with plain crowned muzzle.

AO Safety Economy Hearing Protector... \$10.95 (AOS97035)

This quality set of "ear muffs" - by the makers of the famous Peltor line - offers light weight, rugged construction, and large earcup openings for better fit and comfort. They've been designed for an excellent noise reduction rating of 20 decibels (the range for existing hearing protectors runs from 0 - 30 db. The higher the number, the greater the effectiveness). Quality protection at a great price!



< AO Safety Economy Hearing Protector

Peltor President Hearing Protector...

\$17.50 (AOS97069) The President model from Peltor features exclusive liquid foam ear cushions that are designed for all day comfort. The padded stainless steel wire headband and generously sized earcups automatically self-align for perfect fit and protection. The

President offers a noise reduction rating of 24 decibels, and its earcups can be adjusted in height from the headband. The headband will fold down around the earcups to occupy minimal space when in storage.



Shooter's Scope Stand...

The most solid spotting scope stand you'll find, it features two 3/4" diam. solid 303 Stainless Rods with torque holes for easy dismantling. The stainless base spike has a tapered point and a groove to prevent rotation. The anodized aluminum base and legs (tightened to the base spike with a heavy T-handle bolt) fold out to 28" diameter. The anodize finish is available in red, black or clear. A 1 7/8"



Top Ball is standard and a unique scope mount allows rigid tightening without putting high torque on the hand knobs. Years of testing by High Power Shooters have led to the development of this superb stand. (Scope shown is not included.)

Shooter's Scope Stand...

Red Anodized \$189.95 (Part# FMC-R)

Black Anodized \$189.95 (Part# FMC-B)

Clear Anodized \$189.95 (Part# FMC-C)

BUSHMASTER XM15-E2S Complete Lower Receiver Assemblies...

Why Bushmaster Lower Receivers are the Best...

- Precision machined from high tensile strength 7075 T6 Aluminum Alloy Forgings – Bushmaster **DOES NOT** use castings.
- Bushmaster Receivers are guaranteed for fit and function to ensure that if you ever buy a second Upper Receiver/Barrel assembly, it will be completely compatible and interchangeable with your lower receiver.
- M16 A2 design reinforcement area around front pivot pin and reinforcing ridge over the receiver extension attachment area for extra strength.
- Protective finish: Hard Anodize Military A8625, Type III, Class II finish (lusterless, flat, approximate Black No. 37038 Table IX). We do not paint our receivers.
- Surfaces are bead blasted to a non-reflective matte finish prior to hard anodizing.
- A Nickel Acetate final seal coating protects against corrosion.
- Raised "ridge" around magazine catch button protects against accidental magazine release.
- Standard pivot pin design connects uppers and lowers with captivated front pivot pin and rear take down pin (so the pins can't fall out and become lost).



Bushmaster Lower Receiver Assembly with Pistol Grip
(Part# ALOW W/OSTK)
Complete & Assembled as shown above
(no buttstock parts included)
Suggested Retail Price... \$259.00

Complete Lower Receiver Assembly with A2 Trapdoor Buttstock, Pistol Grip and internal components.

These lowers are complete and assembled – ready to attach to an Upper Receiver and take to the range. The A2 Buttstock is 5/8" longer than the original A1 version for better trigger pull ergonomics, and includes a "trapdoor" storage compartment for cleaning kit, small parts, etc.



Suggested Retail Price... \$295.00 (Part# A LOW STD)
An FFL is required for the purchase of any Lower Receiver. Contact your local FFL Dealer, prices may vary.

Complete Lower Receiver Assembly with BATF Approved Fixed Length Tele-Style Stock, Pistol Grip, and all internal components.

BATF has approved the use of fixed length (non-collapsible) tele-style stocks with Post-Ban manufactured lower receivers, so you can build that military-look carbine you've wanted. You'll need an FFL to purchase this Lower/Stock combination, or you can order the Tele-style stock separately for addition to your post-ban lower - see our Buttstocks section.



Suggested Retail Price... \$339.00 (Part# A LOW PERMX)
An FFL is required for the purchase of any Lower Receiver. Contact your local FFL Dealer, prices may vary.

Bushmaster "Stripped" Lower Receiver... This is the premium quality basis for any Bushmaster Rifle for those who want to "build from the ground up". We recommend the Bushmaster Video or U.S. Gov't. M16 A2 Technical Manual (Gunsmithing Section in this catalog) for complete rifle buildup instructions. You'll need a Complete Lower Parts Kit - see details on next page, and your stock of choice from the Buttstocks Section.

Suggested Retail Price... \$184.00 (Part# 9349102-5)

An FFL is required for the purchase of any Lower Receiver. Contact your local FFL Dealer as prices may vary.



NOTE: BATF RULING PROHIBITS USE OF M16 COMPONENTS IN LOWER RECEIVER.

See Page 23 for an M16 / AR15 parts comparison if you have any doubt about parts in your rifle.
NOTE: Lower Receivers can only be sold through Federally Licensed Firearms Dealers. We've included Manufacturer's Suggested Retail Pricing here as a guide. Prices at your local F. F. L. Dealer may vary.

BUSHMASTER XM15-E2S Lower Receiver Parts & Kits...

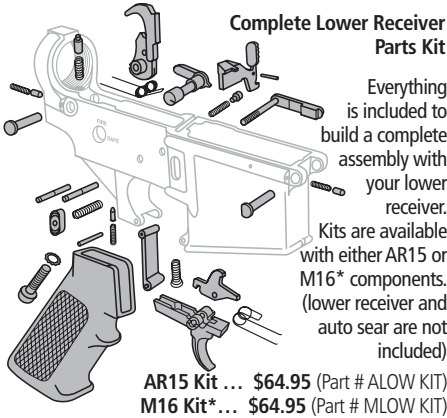

Complete Lower Receiver Parts Kit

Everything is included to build a complete assembly with your lower receiver. Kits are available with either AR15 or M16* components. (lower receiver and auto sear are not included)

AR15 Kit ... \$64.95 (Part # ALOW KIT)
M16 Kit*... \$64.95 (Part # MLOW KIT)

*NOTE: M16 parts require FFL or MG Tax Stamp.
M16 Parts are NOT Legal for Sale in California.

DCM Competition Complete Lower Receiver Parts Kit... \$159.95 (ALOWKITCOMP) All parts shown above plus our Adjustable Two Stage Competition Trigger - save \$25 over separately purchased parts.

Complete Spring Package... \$9.95 Every spring in the gun, including the Buffer Spring. Please specify if for Telesstock Carbine (Part # A COMP SPR PKG-C), or Standard Buffer Spring (Part # A COMP SPR PKG).

Reverse Offset Pin...

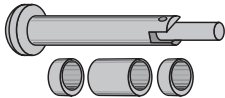

\$15.95 (WE-003)

Allows mounting a Colt Upper Receiver (with large pin holes) to push pin (small hole) style Receiver.

Offset Pin... \$5.95

(NES-06) Adapts a Colt Lower Receiver (with large hole) to M16 Forward Assist type Upper Receiver with smaller hole.



AR-AR Push Pin... \$9.95 (OAK-01)

Replaces the big two screw bolt in the front pivot hole on Colt receivers (will only fit Colt Sporters!) Converts to standard push pin takedown operation like the military version.

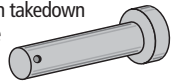

Complete AR15/M16 Pin & Detent Package...

\$6.95 (AR PIN PKG) Includes every pin and detent in the gun - a \$13 value if sold separately. Contains: 2 Hammer/Trigger Pins; 2 Front Sight Taper Pins; Firing Pin Retaining Pin; 2 Takedown Pin Detents; Safety Detent; Bolt Catch Plunger; Extractor Pin; Gas Tube Roll Pin; Front Sight Detent; Ejector Pin; Forward Assist Pin; Bolt Catch Pin; Buffer Detent; Trigger Guard Pin.

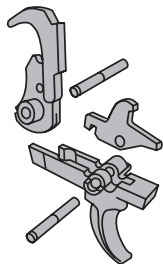

Individual Lower Receiver Parts for Late Model COLT AR'S... Hard to find parts for the late model Colts requiring the larger .172" diameter hammer & trigger pins!

Hammer... \$21.95 (8448612-SCK)

Trigger... \$19.95 (8448592-SC)

Disconnecter... \$6.95 (8448635-SC)

Hammer/Trigger Pin... \$3.00 (8448609-C)

For All 5 Parts in a Kit Package... \$49.95 (Part # AR COLT KIT)

Field Repair Kit... High breakage and loss items in a heavy zip-lock bag. Will fit in Stowaway Grip. Includes extractor, 2 extractor springs, 2 extractor spring insert, disconnecter, gas ring set, extractor pivot pin, firing pin, 2 firing pin retaining pins, cam pin and spring package of six springs. **\$29.95 ea. - Specify whether for...**

AR15 (Part #A FIELD) or M16* (Part #M FIELD)

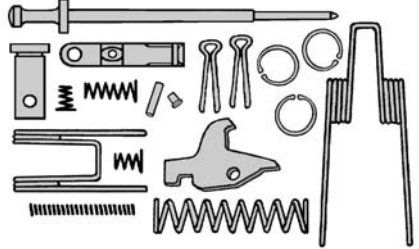

*NOTE: M16 Parts are NOT Legal for Sale in California.

Expandable Tensioning Pin For All AR15 Type Rifles...

\$34.95 (ARTP) These pins are designed to cure the looseness between older upper and lower receivers. Install and tighten with an Allen wrench, and this precision pin pulls the upper receiver down onto the lower for a rock hard custom fit. Improves accuracy in even the poorest fitting upper and lower receivers.

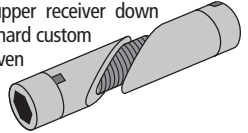

A Complete AR15 Spare Parts Kit... \$36.95 each

We've taken our Field Repair Kit, our Complete Spring Package, and our Complete Pin & Detent Package and combined them into one "super-kit" that will take care of all your AR15 rifle's spare parts needs. See the kit contents descriptions on this page for complete listings of all parts included. Specify your choice of:

Standard Buffer Spring Spare Parts Kit (Part # ARPARTSKIT)

Carbine Buffer Spring Spare Parts Kit (Part # ARPARTSKIT-C)



Tighten your Receiver's Action with Our Receiver Spring Package...

\$2.95 (Part # SM SPRING PACK)

Includes top quality Hammer, Trigger, Ejector, Extractor, Magazine Catch and Disconnecter Springs.

BUSHMASTER XM15-E2S Lower Receiver Parts & Kits...

AR15 or M16* Kit... \$33.95 ea. (A REHAB [for AR15] or M REHAB [for M16]) Hammer, Trigger, Safety Selector and Disconnecter. Specify whether for **Semi-Auto or Full-Auto**. *NOTE: M16 Kit must be used in a Title II Receiver for legality. An FFL or Tax Stamp is required. **M16 Parts are NOT Legal for Sale in California.**

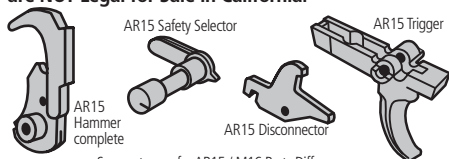

See next page for AR15 / M16 Parts Differences

Anti-Walk Pins... for XM15, AR15 and M16...

Set of 2... \$5.95 (WE-002) Designed to prevent trigger or sear pin walkout under rapid fire conditions. Steel with black phosphated finish.



XM15/AR15/M16 Emergency Survival Kit... Contains more parts than our Field Repair Kit - all packed in a handy O.D. web carrying case you can wear on a belt. Includes cam pin, extractor with 2 pins and 2 springs, firing pin, 2 firing pin retaining pins, disconnecter and spring, hammer with "J" pin and spring, hammer pin, trigger pin, trigger spring, safety detent and spring, magazine catch springs, gas rings (3), sight adjustment tool, and 2 armorer punches for field disassembly.

Specify: A1 type: (round front sight) **or A2 type:** (square front sight) **and AR15 (AR) or M16 (M) parts.** (Note: **M16 parts require an FFL or Form 4 for purchase.**)

Survival Kit with A1 Sight Tool... \$59.95

(AR EMERG A1 / M EMERG A1)

Survival Kit with A2 Sight Tool... \$59.95

(AR EMERG A2 / M EMERG A2)



AR15/M16 Accu-Wedge... \$5.95 (ACU1B)

Accu-Wedge eliminates play between upper and lower receivers for a more solid feel. Buffers the cycling system to reduce wear on the impacting surfaces.

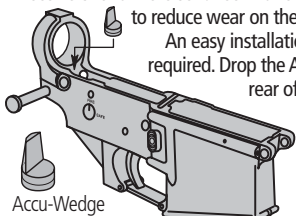

Accu-Wedge
Enlarged

An easy installation, no modifications required. Drop the Accu-Wedge into the rear of the lower receiver -

close the upper receiver, squeeze, and push the take-down pin into place.

M16*A2 Three Shot Burst Set... Installation of this set in your M16A1 machine gun will give you 3 shot burst capability as in the latest M16A2. New mil. spec. parts. FFL required for sale, or a copy of your Form 4.

Not legal for installation in anything but a licensed machine gun. (3SHOT BURST KIT) \$59.95

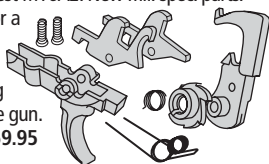

*NOTE: M16 Parts are NOT Legal for Sale in California.

Mil. Spec. M16* Full Auto Sear...

\$29.95 (8448595) Includes Pivot Pin, Bushing and Spring.

Note: Federal Firearms License or Tax Stamp is required for purchase.



AR15 or M16* Ambidextrous Safety Selector...

Don't be penalized for being left handed any longer. Installs easily into your lower receiver and enables activation of the rifle with either hand. Assembles with a button head Allen Screw. For the M16 part, a copy of your Form 4 is required for sale.

AR15 (Part# MMT-0007K) \$34.95

M16* (Part# MMT-0006K) \$34.95

(*NOT Legal in California)



Ambi Magazine Release... \$89.95 (8448638-ambi)

Now, release magazines from either side of the receiver - especially handy for lefties. This well made assembly is an easy replacement for your stock magazine release - uses the stock button and spring. No receiver modification is required, the design reduces the possibility of accidental release, and helps keep out sand and mud. All steel construction with a mil. spec. manganese phosphate finish. Made in U.S.A.



Bushmaster Competition Trigger - For the Serious High Power Competitor... (8448592-SCGK) \$119.95

A finely honed competition trigger including all the specially modified parts shown - ready for installation in your lower receiver. This trigger can be set for a 3 1/2 lb.

DCM legal 1st Stage, and a 1 lb. (2nd Stage) letoff.

ALSO available...

Our 2 Stage Competition Trigger with Ambidextrous Safety... \$139.95 (8448592-SCGKA)

NOTE: This Trigger will not fit in Colt Lowers with Block over Safety. Won't work with large Colt pivot pins.

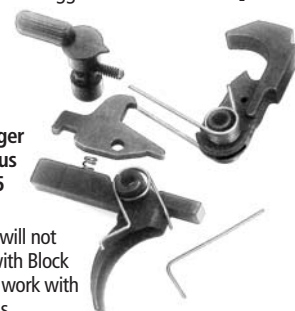

INDIVIDUAL PARTS FOR LOWER RECEIVERS...

Bolt Catch Assembly (A BCAT ASS) **\$5.95**
Bolt Catch (8448628) **\$4.95**
Bolt Catch Spring (8448633) **.50**
Bolt Catch Plunger (8448634) **.50**
Bolt Catch Pin (MS16562-119) **.50**
Buffer Detent (8448582) **\$1.50**
Buffer Detent Spring (8448583) **.50**
AR15 Disconnecter (9349114-S) **\$5.45**
M16 Disconnecter* (8448635) **\$5.45**
Disconnecter Spring (8448594) **.50**
AR15 Hammer w. J pin (8448612-SK) **\$13.95**
M16 Hammer w. J pin* (8448612-K) **\$13.95**
Hammer Pin (8448609), **Trigger Pin** (8448609), or **Sear Pin** (8448599) each... **.95**
Hammer Spring (8448611) **.95**
Magazine Catch Assembly (A MC ASS) **\$4.50**
Magazine Catch (8448638) **\$2.95**
Magazine Catch Button (8448636) **\$1.25**

Magazine Catch Spring (8448637) **.50**
Pistol Grip A2 (9349127) **\$11.95**
Pistol Grip Screw (AN501D416-18) **and**
Pistol Grip Screw Washer (MS35335-61) **.95**
Pivot Pin (Front) (8448621) **\$3.95**
Pivot Pin Detent (8448585) **.50**
Pivot Pin Spring (8448586) **.50**
AR15 Safety Selector (9381367-S) **\$9.95**
M16 Safety Selector* (9381367) **\$9.95**
Safety Detent (8448631) **.95**
Safety Detent Spring (8448516) **.80**
Take Down Pin (Rear) (8448584) **\$3.95**
Take Down Pin Detent (8448585) **.50**
Take Down Pin Spring (8448586) **.50**
Trigger for M16* (8448592) **\$10.95**
Trigger for AR15 (8448592-S) **\$10.95**
Trigger w. Spring for AR15 (9349115-S) ... **\$10.95**
Trigger Spring (8448593) **.95**
Trigger Guard Assembly (8448587) **\$4.95**

***NOTE: M16 Parts are NOT Legal for Sale in California.**

A BUSHMASTER STATEMENT REGARDING MACHINEGUN PARTS

BATF's position is that if your AR15 type rifle contains even one M16 component, it is a Machine Gun. If you own an AR15 from any manufacturer, check to make sure there are no M16 components in it's assemblies. If there are, remove them immediately. Machine them to AR configuration, or replace them and destroy the M16 components. Refer to the illustrations below to determine if you have M16 components in your assemblies. If you have any questions about your parts, give us a call and we'll be glad to supply you with the legally acceptable parts.

Sales of M16 components by Bushmaster/Quality Parts Co. will only be made to the following categories of customers: (1) Class 3 (NFA) Dealer. (2) Individual who has a registered NFA weapon. (3) Federal Firearms Licensee with a customer who has a registered NFA weapon.

Note the Differences* Between the Corresponding Parts in Each Drawing

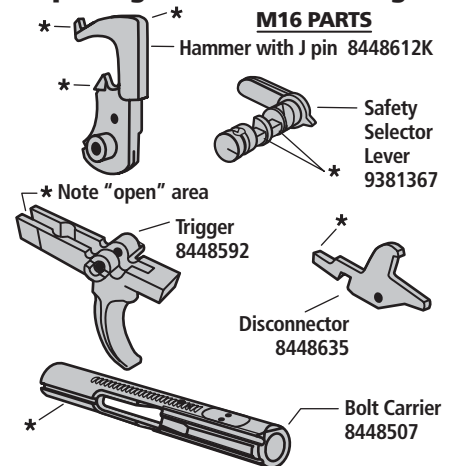
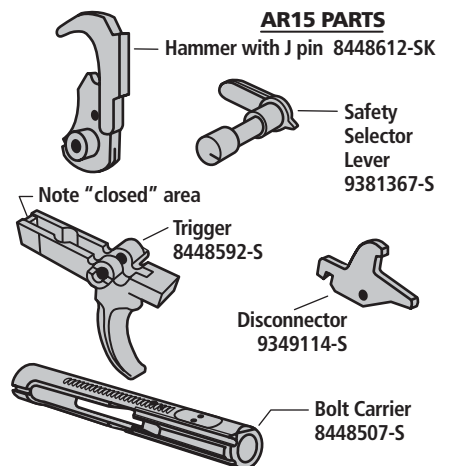

Uzi SMG Bolt... A full auto bolt machined from 4140 quality gun steel bar stock - not a weak or porous casting. Sear notch tolerance is held to +/- 1 degree to reduce sear wear and assure precise lockup.

\$150.00
 (MMT-Z-200)

Uzi Auto Recoil Spring...

A top quality spring assembly - tension tested to ensure a consistent cycle rate of 600 RPM.
\$19.95 (MMT-0009)

Bushmaster Upper Receivers...



Complete A2 Upper Receiver... \$174.95 (A2UR) Assembled with the A2 rear sight, ejection port cover, and forward assist assemblies. Bushmaster receivers, forged of 7075T6 aircraft quality aluminum, are machined to mil. spec. or better, and hard anodize finished to a dark gray non-reflective finish. They include the latest integral brass deflector and they are dry film lube coated inside for long wear and smooth carrier operation. Does not include charging handle.

Bushmaster A2 Stripped Upper Receiver... \$114.95

(9349063) This ready-to-assemble, fully machined, anodize finished and dry lubed forging is top Bushmaster quality. Start building your AR rifle with the best new stripped upper receiver available. Requires a rear sight; forward assist assembly and ejection port cover assembly for completion - all parts and tools to help assemble your Bushmaster Upper are available in this catalog. Also see our Parts Schematic on Pages 40/41.



Bushmaster A1 Upper Receivers...

The early AR15/M16 Upper Receiver differed from the current configuration in that its simpler rear sight did not include an elevation adjustment. The Forward Assist Assembly often utilized the "tear-drop" type button (although it is mechanically identical in function to the round type). Aircraft quality 7075T6 aluminum forgings are used for strength, and they include the integral cartridge case deflector.

The finish is a mil. spec., non-reflective hard anodize with an internal baked on dry film lube coating to ensure long wear and smooth carrier operation. **Complete A1 Upper Receiver Assembly... \$144.95** (Part# A1UR) (includes Forward Assist Assembly, Ejector Cover Assembly and A1 Sight Assembly).



Stripped A1 Upper Receiver Assembly... \$114.95

(8448524) Shown at right, this is a fully machined and finished forging ready for assembly - does not include the parts or assemblies listed above.



V Match Upper Receiver Assembly - with integral Picatinny optics mounting rail...

\$171.95 (Part # VUR) This is the popular A3 type "flat-top" Upper Receiver. It's Picatinny configuration rail allows mounting the wide variety of scopes, sight and optics available in the AR system. It has been carefully machined from a 7075T6 aircraft aluminum forging and is complete as shown with Ejection Port Cover and Forward Assist.



Stripped V Match Upper Receiver... \$141.95

(Part # 8448524-V) A fully machined and anodize finished forging ready for your parts - requires the ejection port cover and the forward assist.

Bushmaster Upper Receiver Parts...

Bushmaster Complete Bolt and Bolt Carrier Assembly... \$129.95

For AR15 - Part # 8448501-S

For M16* - Part # 8448501

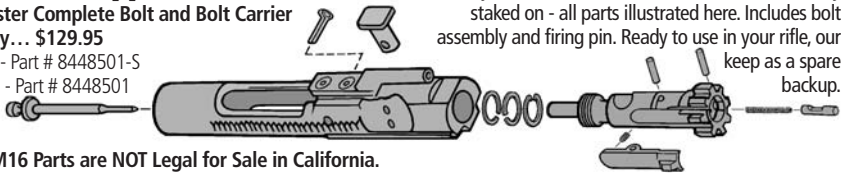

*Note: M16 Parts are NOT Legal for Sale in California.

AR15 or M16 Bolt Carrier Assembly with Key Staked on... \$86.95 each These are new bolt carriers machined of highest quality gun steel - not rewelds or remakes - and they are chrome lined for smooth bolt functioning and long life. The bolt carrier assembly is the "heart" of your rifle - with the most critical machining tolerances of any component in the weapons system. We manufacture to mil. spec. or better, and magnetic particle inspect to insure against cracks or flaws that could cause catastrophic failure or injury.

For AR15... \$86.95 (8448505-S)

For M16*... \$86.95 (8448505)

*NOTE: M16 Bolt Carriers must be used in Title II Receivers for legality.



AR15 or M16 Bolt Carrier without Key... \$73.95 each Same quality chrome lined Carrier as above without the key for the "do-it-yourselfer".

For AR15... \$73.95 (8448507-S)

For M16*... \$73.95 (8448507)

NOTE: Bolt Carrier Keys must be "staked" onto the carrier

for proper and safe functioning in your rifle. *M16 Parts are NOT Legal for Sale in California.

For information on this procedure, or any AR15 assembly/disassembly work, we recommend the Bushmaster Video or the U.S. Government M16 Technical Manual - see the Gunsmithing Section of this catalog.



Complete AR15 Bolt Assembly... \$52.95 (8448509)

Includes Bolt, Extractor Assembly, Pins, Gas Rings, Ejector Assembly, all top quality parts completely assembled, and ready for the field.

Parts detail illustration...



Bolt Carrier Converter... \$19.95 (MMT-0008) Adding this two piece unit to the semi-auto bolt carrier allows it to function as an M16* carrier. Manufactured of the same gun quality steel as the bolt carrier, and heat treated to the same specifications. Dimensions of this converter are designed so that it will cause no distortion of the carrier when installed.

NOTE: Must be used with a Title II Receiver for legality. An FFL or Tax Stamp is required for purchase. *NOT Legal for Sale in State of California.



For AR15... (8448503-S) \$6.95

For M16... (8448503) \$6.95

Titanium Firing Pin... \$39.95 (13-7015) 40% lighter than steel for faster lock time and greater accuracy. Precision machined and patented. Increases your safety by reducing the possibility of a "slam fire".

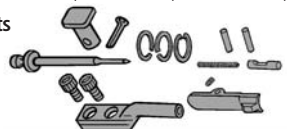

Bushmaster Upper Receiver Parts...

Forward Assist Assemblies... \$19.95 ea.

"Teardrop" or Round Style

These assemblies are machined from 4140 ordinance steel - heat treated to mil. spec. to avoid gouged bolt carrier problems or wear on the pawl tip - finish is Manganese Phosphate.



Teardrop Style... \$19.95 (9349086-TD KIT)

Round Style... \$19.95 (9349086 KIT)

AR15/M16 Charging Handle Tactical Latch... \$19.95

(1005-249-02) Improves on the standard charging handle latch - allows easy weapon charging and left hand operation when using a scope or other optics. Sturdy steel construction. Installation is a simple replacement - don't lose your existing latch spring or pin when you change over to this latch on your charging handle.



Charging Handle Assembly... \$24.95
(Part # 8448517)



These are not steel stampings that might bend or distort from heat buildup. Precision machined from 7075T6 aircraft quality aluminum forgings, they are hard anodize finished per U. S. mil. spec. - with latch installed.

Ambidextrous Tactical Latch for the AR15/M16 Charging Handle... \$19.95 (ambi-tac) Cycle the charging handle with left or right hand - especially useful on scoped rifles. A right-handed thumb and forefinger pinch releases the charging handle from the right side, or use a straight pullback from the left hand. Fits AR15/M16, AR10,

or SR-25 rifles. Black finish.



INDIVIDUAL PARTS FOR UPPER RECEIVERS... See Pages 40/41 for complete Parts Diagram

Bolt Cam Pin (8448502) \$3.95

Bolt Carrier Key with screws/must be staked (AR BC KEY/SCREW) \$14.95

Bolt Gas Rings (set of 3) (8448511K) \$2.95

Ejector Assembly (A EJECT ASS) \$2.95

Extractor Assembly (A EXTRAC ASS) \$13.95

Extractor (8448512) \$12.95

Extractor Pin (8448513) \$.95

Extractor Spring (8448755SP) \$1.30

Extractor Spring Insert (8448754)75



Firing Pin (8448503 or 8448503-S) \$6.95

Firing Pin Retaining Pin (8448504) \$.95

BUSHMASTER UPPER RECEIVER/BARREL ASSEMBLIES...

Swap them out as needed on your lower receiver to appreciate the versatility designed into the Bushmaster system! Bushmaster Upper Receiver/Barrel Assemblies offer the benefit of the years of AR15/M16 design, materials and finish improvements. Either our Chrome-Moly Vanadium Steel Barrels with hard chrome lining in both bore and chamber, or our Stainless Steel Barrels, are the finest available. The latest M16A2 sight systems; integral brass defectors and hard anodize finish are incorporated into the receivers. These assemblies are all factory headspaced, test fired, and shipped completely ready to use. They include charging handle, bolt and bolt carrier assemblies, handguards and forends. They can also be purchased without charging handle, bolt and bolt carrier assemblies if you already have those parts in another rifle. Just swap them over - that's the beauty of the Bushmaster weapons system.

NOTE: The sale of assemblies in "Pre-Ban" configuration (i.e. with bayonet lugs, flash suppressors, telescoping stocks) are intended for use as repair parts only. Such assemblies MAY NOT BE USED TO CREATE NEW ASSAULT WEAPONS as defined by the Gun Legislation of 1994.

Bushmaster Upper Receiver/Barrel Assemblies are available with Flash Suppressor  and Bayonet Lug,  but with those options, are legal *only* on a Pre-Ban lower receiver or rifle.

OPTIONS for Bushmaster Upper Receiver/Barrel Assemblies...

We manufacture hundreds of different combinations - add the options below to the price of the assembly you choose. If you have any questions about the function, compatibility or legality of the various configurations, please consult with your Bushmaster salesperson.

For Fluting - available on most Bushmaster barrels (Some exceptions. Add F as suffix to Part #) **Add \$50.00**

For Assemblies with V Match "flat-top" Upper Receiver (Substitute A3 for A2 in part #) **No Addtl. Charge**

For A1 Upper Receiver Assembly with A1 Rear Sight (Substitute A1 for A2 in part #) **Subtract \$30.00**

Note: Our A3 Removable Carry Handle is optionally available with V Match Uppers (9349063-9) **Add \$99.95**

For Assemblies with V Match round aluminum Free-floater Forend (SGW-01/02) **Add \$40.00**

For Assemblies with Varminter vented aluminum Free-floater Forend (VAR-01) **Add \$60.00**

See our Barrel Parts Section for details on a variety of optional Muzzle Brakes and Flash Suppressors...



Izzy Brake

A2 Birdcage

Y Comp

Mini Y Comp

AK Brake

Phantom

Bushmaster Upper Receiver/Barrel Assemblies...

New... "Modular Carbine" Upper Receiver/Barrel Assembly...



\$910.00 (# PURVMB 16FMC)

Due to popular demand, Bushmaster now offers the upper receiver/barrel assembly from our 16" Modular Carbine. This Upper has a 16" Chrome Lined Chrome Moly Steel fluted barrel with a milled gas block. A Four Rail Free-Floater Tubular Forend combines with the A3 type "flat-top" Upper Receiver to provide all the Picatinny rails necessary for mounting a wide variety of sights, scopes or accessories. Molded Rubber Sure Grip Rail Covers snap over the rail sections on the handguard to add comfort and protection as a heatshield. The B.M.A.S. Rear Flip-up Sight is a dual aperture detachable unit with a windage knob calibrated to 1/2 Minute of Adjustment. The B.M.A.S. Front Flip-up Sight clamps around the milled front gas block. It folds down with the touch of a button to allow scope use and incorporates an elevation adjustable M16A2 front sight post. The forged, lightweight, 7075T6 aircraft quality aluminum receiver includes brass deflector, dust cover and forward assist. Complete, assembled, and ready for your lower receiver.

The Bushmaster "Varminter" Upper Receiver/Barrel Assembly...



\$725.00 (PURVMB 24FVAR9)

The complete upper half of our very successful - and very accurate - Varminter features a 24" Fluted Extra Heavy Barrel in 5.56mm/.223 Rem. caliber with 11° competition crown; full 1" diameter under the handguard; SAAMI spec. chamber; 1 in 9" twist for optimum performance with most varmint cartridges and fluting for increased cooling and reduced weight. It is machined to same tolerances as our DCM Competition Barrels and sold complete with Bolt, Bolt Carrier and Charging Handle to ensure accuracy. The Varminter's shell ejection path has been modified to drop all your brass in the same place as a convenience for the reloader. A vented forend free-floats the barrel from the barrel nut forward, and a bipod/sling stud is installed for mounting of most bipods. Finally, our B.M.A.S. Mini-Risers add 1/2" to scope height on the flat-top receiver for correct sight picture and comfortable cheek weld.

"Varminter Special" Stainless Upper Receiver/Barrel Assembly...



\$725.00 (PURVMB 24-9SS)

From our Stainless Varmint Special Rifle, this complete assembly features a finely machined and polished 24" Stainless Steel Barrel (5.56mm/.223 Rem. caliber) free-floated within our vented aluminum tubular forend. The barrel is button rifled in a right hand 1 in 9" twist to offer superb accuracy with a wide range of varmint cartridges. As a safety and convenience feature, the shell ejection path has been designed to drop all cases in the same place and on the "flat-top" Upper Receiver Picatinny rail, we've added 1/2" B.M.A.S. Mini-Risers to help mount your scope properly for correct sight picture and comfortable cheek weld. A bipod stud is installed on the forend for easy addition of most bipods or a sling.

Same Assembly without Bolt Carrier Assembly and Charging Handle... **\$585.00** (PURVM 24-9SS)

Bushmaster DCM Competition Upper Receiver/Barrel Assembly...



\$765.00
(PURA2B 20CG8)

For the serious High Power Competitor - this Upper Assembly features all the "bells and whistles" needed to win! See Pages 15/16 in our Competition Section for complete details on this highly accurate 5.56mm/.223 Remington Competition Upper Receiver/Barrel Assembly.

Bushmaster Upper Receiver/Barrel Assemblies...

ARMS S.I.R. System - available as complete Bushmaster Upper Receiver/Barrel Assemblies...

Complete Bushmaster Upper Receiver/Barrel Assemblies with the ARMS S.I.R. System installed and ready for use...

Commercial (Post-Ban) Model... \$935.00 (Part # PURA3B 16SIR)

16" A3 ARMS S.I.R. Upper

Receiver/Barrel Assembly shown is complete and ready to snap on to your lower receiver. Note: the "Pre-Ban" Military model (shown below) includes flash suppressor and bayonet lug, and can only be used with Pre-Ban lower receivers.

See additional ARMS S.I.R. Systems in our Scopes/Sight Mounts Section of this catalog.

Military (Pre-Ban) Model... \$935.00 (Part # BURA3B 16SIR)

Note: Other barrels can be ordered with the ARMS S.I.R. System. Consult your Bushmaster salesperson.

11.5" Upper Receiver/Barrel Assembly

\$535.00 (BURA2B 11.5)



Without Bolt, Bolt Carrier Assembly & Charging Handle
\$395.00 (BURA2 11.5)

An ideal package for the law enforcement professional, its compact size offers easy handling in close quarters and squad cars. Pre-Ban features and the short barrel length require that these uppers be used on full automatics, or registered short barreled rifles. Configurations with the A3 "flat-top" upper receiver are also available at no extra cost (see *Options - Pg. 26*). Other flash suppressors are also available as factory installed options.

11.5" Upper Receiver/Barrel Assembly with 5.5" Flash Suppressor...

\$535.00 (BURA2B 11.5/5.5)



Without Bolt, Bolt Carrier Assembly & Charging Handle
\$395.00 (BURA2 11.5/5.5)

Our 5.5" CAR 15 Extended Flash Suppressor is pinned onto this 11.5" barrel, and welded to meet 16" total barrel length requirements. (Note: flash suppressors are legal for use only on Pre-Ban lower receivers or rifles.) Choose either the A2 "handle style" upper receiver or the A3 "flat-top" upper - at no difference in cost (see *Options - Pg. 26*), and specify either a full front sight base and sight, or the milled version.

14.5" Heavy Upper Receiver/Barrel Assembly...

\$535.00 (BURA2B 14.5)



Without Bolt, Bolt Carrier Assembly & Charging Handle
\$395.00 (BURA2 14.5)

This lightweight carbine upper can be ordered with either the A2 Upper Receiver or the A3 "flat-top" style upper (see *Options - Pg.26*). The barrel is full heavy profile and chrome lined in both bore and chamber. The A2 birdcage suppressor is standard. The bayonet lug and barrel length make this a Pre-Ban Upper legal for use only on weapons registered as pistols or full-automatic rifles. Other flash suppressors / muzzle brakes are available as optional installations.

Bushmaster Upper Receiver/Barrel Assemblies...

14.5" M4 Post-Ban Upper Receiver/Barrel Assembly with Fixed Mini Y Comp... **\$570.00** (PURA2B 14M4MY)



Without Bolt, Bolt Carrier Assembly & Charging Handle
\$430.00 (PURA2 14M4MY)

By permanently pinning/welding our Mini Y Comp Muzzle Brake to the popular, light weight, 5.56mm/.223 Rem. caliber M4 type barrel, we've received BATF approval to use these assemblies with Post-Ban lower receivers. They are perfect for home protection, Three Gun Matches, or Saturday plinkin' at the sandpit. As shown above, they can be ordered in either A2 (carry handle) or A3 (flat-top) receiver versions (see *Options - Pg. 26* for ordering information).

14.5" M4 Type Upper Receiver/Barrel Assembly...



\$535.00 (BURA2B 14.5M4)
Without Bolt, Bolt Carrier Assembly & Charging Handle
\$395.00 (BURA2 14.5M4)

This "Pre-Ban" Assembly is legal for installation only on weapons registered as pistols or full-automatic rifles. The light weight, chrome lined barrel has the M4 "cutout" profile and will mount the M203 Grenade Launcher. The A2 Upper Receiver/Barrel Assembly with standard birdcage flash suppressor is shown - see *Options* for ordering A3 versions (flat-top/less handle).

Patrolman's Carbine 16" M4A2 Type Upper Receiver/Barrel Assemblies...



With a light weight, M4 profile barrel - stretched to 16" length - the Patrolman's Carbine is available in either Pre-Ban or Post-Ban models, and is popular as a personal duty carbine with many L.E. Officers. To comply with regulations, the Pre-Ban model may only be used on Pre-Ban Lower Receivers. See our *Options* listings for ordering A3 "flat-top" versions (no extra charge).

16" M4 Upper Receiver/Barrel Assembly... **\$545.00** (Pre-Ban: BURA2B 16M4 / Post-Ban: PURA2B 16M4)
Without Bolt Carrier Assembly & Charging Handle... **\$405.00** (Pre-Ban: BURA2 16M4 / Post-Ban: PURA2 16M4)

Dissipator 16" Upper Receiver/Barrel Assembly... **\$535.00** (Postban: PURA2B 16D / Preban: BURA2B 16D)



A2 Type Post-Ban Assembly shown. A3 Type Receivers also available. Pre-Bans also available.

Introduced in '94 and unique in the Bushmaster line - this 16" Barrel configuration features full length handguards with aluminum heatshields to dissipate heat quickly. The front sight is placed so as to obtain the full sight radius designed into the M16A2 sight system. The Dissipator barrel is hard chrome lined in both bore and chamber. A3 "flat-top" configuration assemblies are available at no extra charge (see *Options - Pg. 26* for ordering information).

Without Bolt Carrier Assembly & Charging Handle... **\$395.00** (Postban: PURA2 16D / Preban: BURA2 16D)

Bushmaster Upper Receiver/Barrel Assemblies...

16" Carbine A2 Upper Receiver/Barrel Assembly... \$535.00 (Postban: PURA2B 16) (Preban: BURA2B 16)



16" Carbine
A2 Type Assembly

16" Carbine with A3 Type
"Flat-top" Upper

**Without Bolt Carrier Assembly
& Charging Handle... \$395.00**

(Postban: PURA2 16 / Preban: BURA2 16)

Bushmaster's 16" chrome lined, heavy profile, carbine barrels - all headspaced, test fired, and ready for your lower receiver - include short carbine handguards. These convenient and light weight assemblies are available with either A2 solid carry handle Upper Receiver or "Flat-top" (no carry handle) configurations (to order change Part # to A3). Also specify the full front sight base, or the milled (both shown above). Pre-Ban versions with bayonet lugs and A2 birdcage flash suppressors, are available (see Pre-Ban part numbers listed second).

AK Carbine Upper Receiver/Barrel Assembly... \$560.00 (Postban: PURA2B 14AK) (Preban: BURA2B 14.5AK)

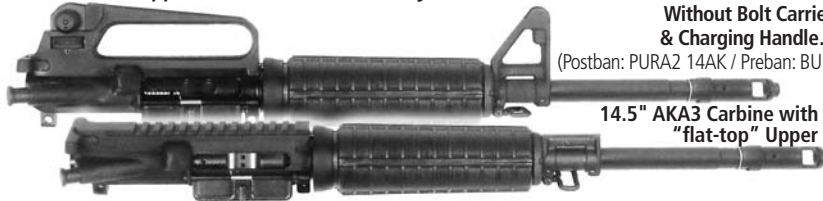

**Without Bolt Carrier Assembly
& Charging Handle... \$420.00**

(Postban: PURA2 14AK / Preban: BURA2 14.5AK)

14.5" AKA3 Carbine with
"flat-top" Upper

Bushmaster's AK Type Muzzle Brake has been permanently fixed (pinned and welded) onto this assembly's 14.5" barrel, making it the 16" minimum legal "Post-Ban" length. Order it with either the A2 solid carry handle Upper Receiver or the A3 "flat-top" Upper at no extra cost (A3 Carry Handle is not included). This heavy profile, 14.5" barrel is chrome lined and button rifled 1 turn in 9" - right hand twist. Pre-Ban versions can only be used on Pre-Ban lower receivers.

SuperLite Upper Receiver/Barrel Assembly... \$535.00 (Postban: PURA2B 16SL) (Preban: BURA2B 16SL)



**Without Bolt Carrier Assembly
& Charging Handle... \$395.00**

(Postban: PURA2 16SL / Preban: BURA2 16SL)

This assembly features the lightest 16" barrel we've ever offered - a complete A2 assembly weighs only 3.8 lbs. Available in A2 (solid carry handle Upper) or A3 "flat-top" Upper configurations (A3 carry handle is not included), this barrel is .625" in diameter from the chamber forward - similar to the original Vietnam era A1 barrel profile.

V Match Rifle & Carbine Upper Receiver/Barrel Assemblies... are defined by the "flat-top" Upper Receiver and a hard anodized, tubular, aluminum free-floater forend to offer accuracy and sight mounting versatility. Specify full or "milled" front sight base (milled shown).



20" Bbl. V Match Upper Receiver/Barrel Assembly... \$575.00 (Postban: PURVMB 20AH / Preban: BURVMB 20AH)

Without Bolt, Bolt Carrier Assy. & Charging Handle... \$435.00 (Postban: PURVM 20AH / Preban: BURVM 20AH)

24" Bbl. V Match Upper Receiver/Barrel Assembly... \$585.00 (Postban: PURVMB 24AH / Preban: BURVMB 24AH)

Without Bolt, Bolt Carrier Assy. & Charging Handle... \$445.00 (Postban: PURVM 24AH / Preban: BURVM 24AH)

16" Bbl. V Match Upper Receiver/Barrel Assembly... \$575.00 (Postban: PURVMB 16 Preban: BURVMB 16)

Without Bolt, Bolt Carrier Assy. & Charging Handle... \$435.00 (Postban: PURVM 16 / Preban: BURVM 16)

Bushmaster Upper Receiver/Barrel Assemblies...

20" & 24" National Match Target Model Upper Receiver / Barrel Assemblies...

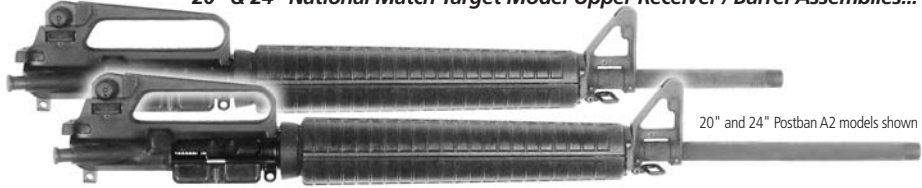

20" and 24" Postban A2 models shown

Rifled 1 turn in 9", these heavy profile, hard chrome lined barrels deliver Bushmaster accuracy for match competitors worldwide. The A2 Upper Receiver is complete with dual aperture rear sight, charging handle, forward assist, ejection port cover, bolt, bolt carrier assembly and handguards. These assemblies are headspaced, test fired, and ready to snap onto your lower receiver. Pre-Ban versions of these assemblies - with bayonet lugs and A2 birdcage flash suppressors are also available (see Pre-Ban part numbers below) but due to the Gun Legislation of 1994, they are legal for use only with Pre-Ban lower receivers.

20" Bbl. Target Model Upper Receiver/Barrel Assembly... **\$535.00** (Postban: PURA2B 20 / Preban: BURA2B 20)
 Assembly without Bolt Carrier Assembly & Charging Handle... **\$395.00** (Postban: PURA2 20 / Preban: BURA2 20)

24" Target Model Upper Receiver/Barrel Assembly... **\$545.00** (Postban: PURA2B 24 / Preban: BURA2B 24)
 Without Bolt Carrier Assembly & Charging Handle... **\$405.00** (Postban: PURA2 24 / Preban: BURA2 24)

20" & 24" A3 "Flat-top" National Match Target Model Upper Receiver / Barrel Assemblies... also available at no additional cost (see *Options* below). Specify full or milled front sight base.



20" Postban A3 w. milled front sight base shown

Bushmaster Stainless Steel Barrelled Upper Receiver Assemblies...



These Bushmaster Stainless Steel Barrels are machined to our strictest standards.

A2 Carry Handle configuration... (PURA2B 20SS)

These assemblies answer the many requests to build Bushmaster accuracy in Stainless Steel configurations - just snap this complete assembly on your lower receiver and you're ready for the high power range. Assemblies are complete with Bushmaster forged Upper Receivers with Match Grade Polished Stainless Steel Barrels (1 in 9" right hand twist, button rifled). Stainless Barrelled Assemblies are also available in A3 "flat-top" configurations at no extra charge. To order, change the A2 in Part # to A3. (Note: A3 flat-top Assemblies do not include A3 Removable Carry Handle.)

20" Upper Receiver/Barrel Assembly (shown above) - **\$585.00** (PURA2B 20SS)
 Assembly Without Bolt, Carrier or Charging Handle... **\$445.00** (PURA2 20SS)

A3 Flat-top configuration (PURA3B 20SS)



OPTIONS for Bushmaster Upper Receiver/Barrel Assemblies...

We manufacture hundreds of different combinations - add the options below to the price of the assembly you choose. If you have any questions about the function, compatibility or legality of the various configurations, please consult with your Bushmaster salesperson.

For Fluting - available on most Bushmaster barrels (Some exceptions. Add F as suffix to Part #) **Add \$50.00**

For Assemblies with V Match "flat-top" Upper Receiver (Substitute A3 for A2 in part #) **No Addtl. Charge**

For A1 Upper Receiver Assembly with A1 Rear Sight (Substitute A1 for A2 in part #) **Subtract \$40.00**

Note: Our A3 Removable Carry Handle is optionally available with V Match Upppers (9349063-9) **Add \$99.95**

For Assemblies with V Match round aluminum Free-floater Forend (SGW-01/02) **Add \$40.00**

For Assemblies with Varminter vented aluminum Free-floater Forend (VAR-01) **Add \$60.00**

See our Barrel Parts Section for details on a variety of optional Muzzle Brakes and Flash Suppressors...



Izzy Brake

A2 Birdcage

Y Comp

Mini Y Comp

AK Brake

Phantom

Bushmaster Barrels... are the finest AR15/M16 type barrels made - machined from Chrome-Moly Vanadium steel - Rockwell C26 to 33 hardened. We also offer 20"/24" Heavy Profile Barrels machined from Stainless Steel. Most Bushmaster barrels are hard chrome lined (except the Stainless Steel barrels) to offer corrosion resistance in the bore and chamber. Chrome is more than twice as hard as barrel steel and effectively doubles barrel life with proper care (exactly why the military specifies the process). Chrome's lubricity (i.e. "slipperiness") reduces friction, increases velocity, aids in chambering, extraction, and speeds barrel cleaning. Bushmaster barrels are manganese phosphate finished (again except the Stainless) to guard against exterior rust or corrosion, and to provide the same matte black, non reflective finish found on quality military arms.

Rifling... Bushmaster barrels are button rifled with 6 grooves and lands (right hand twist, 1 turn in 9", except for DCM barrels - 1 in 8"). The 1 in 9" twist offers optimal results with the widest variety of commercially available ammunition. Most barrels are heavy profile their full length - to improve accuracy and alleviate barrel whip.

Forged Front Sights... Our front sights are machined steel forgings offering superior tensile strength. We do not use castings, which may crack or break if you accidentally drop your rifle.

Headspacing... Barrel assemblies are headspaced at the factory and are shipped ready for assembly and use. Barrel assemblies can be ordered with either a stepped, crowned muzzle (for Post-Ban rifles) or a threaded muzzle for attachment of a flash suppressor or muzzle brake (legal for use only on Pre-Ban lower receivers). BATF rulings permit permanent factory installation of muzzle brakes on certain Post-Ban barrels if overall length equals at least 16". Ask your Bushmaster representative about muzzle brake options available for Post-Ban barrels, or see Pages 36 and 37.

"Barrel Only"... All Bushmaster barrels can be purchased as "Barrel Only" - which includes the barrel; barrel nut; handguard cap and complete front sight assembly with sight post and sling swivel. This offers a savings to those shooters who already have handguards. Pre-Ban configurations when sold as "Barrel Only" will include a bayonet lug on the front sight base. **"Barrel Only" assemblies do not include flash suppressors.**

Barrel Fluting... is the process of milling 6 lengthwise grooves into the barrel's surface to increase cooling capability by increasing the barrel's surface area. Depending upon barrel length, fluting increases surface area by as much as 180% - and can reduce barrel weight by as much as 20%. Because of the extensive machining involved, order fulfillment on fluted barrels can take longer. Ask your sales representative about availability when ordering fluted barrels. To order your Bushmaster barrel with fluting, simply **ADD \$50.00** to the price of the barrel (or assembly), and add an **"F"** to the end of the part number. **Note: Fluting is not available on some barrels, such as the A2 Gov't. Profile or the M4 Type Barrel. Fluting is included on our Varminter Barrel (see Page 35).**

Bushmaster "Short Barrelled" Assemblies...



These chrome lined Pre-Ban barrel assemblies may only be used on registered short barrelled rifles, or full auto models for legality. They include barrel, sight, gas tube, delta ring kit, handguards, heat shields and A2 birdcage flash suppressor. **11.5" Barrel Assembly (above left) \$219.95** (A BBL-11.5A) / **11.5" "Barrel Only" \$195.00** (A BBL-11.5)

("Barrel Only" includes barrel, barrel nut, handguard cap and front sight - no flash suppressor).

14.5" Heavy Barrel Assembly (above right) \$209.95 (A BBL-14.5A) / **14.5" Heavy "Barrel Only"... \$185.00** (A BBL-14.5) Assembly less handguards, gas tube, delta ring kit and flash suppressor.

Note: with a permanently fixed Phantom suppressor, the 14.5" Heavy Barrel Assembly becomes a legal 16" Pre-Ban barrel. Consult with your Bushmaster salesperson for details.

11.5" Heavy Barrel Assembly with 5.5" Flash Suppressor... \$209.95 (Pre-Ban Only: A BBL-11.5WA) A chrome lined 11.5" barrel with 5.5" Flash Suppressor permanently attached for a total length of 16" - making it legal for use on Pre-Ban lowers only. This assembly includes barrel, barrel nut, gas tube, front sight, handguards, heat shields, and 5.5" CAR 15 Extended Flash Suppressor.



11.5" Heavy Barrel Assembly with AK Muzzle Brake... \$239.95 (Pre-Ban configuration: A BBL-11.5WAKA / Post-Ban configuration - no bayonet lug: P BBL-11.5WAKA) A chrome lined 11.5" heavy barrel assembly with a 5.5" AK Muzzle Brake permanently attached for legality (makes a 16" length assembly). All parts from Upper Receiver forward - as shown - are included.

11.5" Heavy AK Barrel Only... \$215.00 (Pre-Ban: A BBL-11.5WAK / Post-Ban: PBBL-11.5WAK) Assembly less handguards, gas tube and delta ring kit.

Bushmaster Barrels & Barrel Parts...

14.5" M16 M4 Type Carbine Barrel Assembly... \$219.95 (A BBL-14M4A) This Law Enforcement / Military barrel is under the 16" legal minimum for semi-auto weapons, and can only be installed on registered full autos or legal short barreled rifles. It is machined for the addition of the M203 grenade launcher and has the narrow "government" profile under the handguards (like the original A1 rifle barrel).



Barrel Only... \$195.00 (A BBL-14M4) Assembly less handguards, gas tube, delta ring kit and flash suppressor.

Note: With a permanent Phantom suppressor, this becomes a legal 16" Pre-Ban barrel. With a permanent Izzy Brake less the bayonet lug, this would be a legal 16" Post-Ban barrel.

14.5" Post-ban M4 Type Barrel Assembly with Mini Y Comp... \$259.95 (P BBL-14M4MYA) BATF approves permanently pinned and welded muzzle brakes on barrels if the total length (brake & barrel) becomes 16" or over. Our 14.5" M4 Type barrel with factory Mini Y Comp meets those standards and is legal for use on your Post-Ban lower receiver. Includes barrel, sight, handguards, shields, gas tube, delta ring and Mini Y-Comp brake - ready to assemble into that perfect 3 Gun Match carbine, plinker or home defense special.



Also available with Izzy Brake.

14.5" Post-ban M4 Barrel Only... \$235.00 (P BBL-14M4MY) Assembly less handguards, gas tube and delta ring kit.

14.5" Heavy Barrel with AK Muzzle Brake... \$239.95 (Pre-Ban: A BBL-14.5AKA / Post-Ban: P BBL-14AKA) A chrome lined 14.5" heavy barrel with our AK style Muzzle Brake permanently attached for legality on semi-automatic weapons.

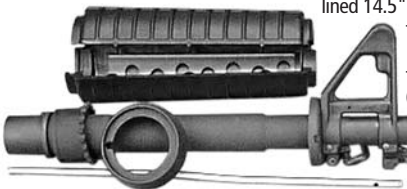

14.5" Heavy AK Barrel Only... \$215.00 Less handguards, gas tube and delta ring kit. Includes the AK Brake. (Pre-Ban: A BBL-14.5AK / Post-Ban: P BBL-14AK)

Note: With a permanent Izzy Brake less the bayonet lug, this would be a legal 16" Post-Ban barrel.

14.5" M4 Type Barrel with AK Muzzle Brake... \$239.95 (Pre-Ban: A BBL-14M4AKA / Post-Ban: P BBL-14M4AKA) A chrome lined 14.5" M4 type barrel with our AK type Muzzle Brake permanently attached for legality on semi-automatic weapons. Complete including all parts from upper receiver forward. The Pre-Ban version of this barrel (as shown here) has a bayonet lug and is for use only on Pre-Ban lower receivers. Ask for legal details.



14.5" M4 with AK Muzzle Brake - Barrel Only... \$215.00 (Pre-Ban: A BBL-14M4AK / Post-Ban: P BBL-14M4AK) Same assembly less handguards, gas tube and delta ring kit.

Patrolman's Carbine - M4 Type 16" Barrel Assembly... \$219.95 (A BBL-16M4A / P BBL-16M4A) This design features the light weight (2.14 lbs. for "Barrel Only") of the military M4 type carbine in a 16" length. With distinctive M4 profile, this assembly includes barrel, sight, handguards, shields, gas tube, delta ring kit and is available in Pre- or Post-Ban versions. Factory installed muzzle brakes for Post-Ban models are available. The Pre-Ban version (shown here) includes bayonet lug, threaded muzzle & birdcage flash suppressor.



Patrolman's Carbine - Barrel Only... \$195.00 (Pre-Ban: A BBL-16M4 / Post: P BBL-16M4)

Assembly less handguards, gas tube, delta ring kit, & flash suppressor.

A variety of optional Muzzle Brakes and Flash Suppressors are available for these Barrels - See Pages 36 & 37.



Izzy Brake
\$34.95



A2 Birdcage
\$5.95



Y Comp
\$45.95



Mini Y Comp
\$29.95



AK Brake
\$25.95



Phantom
\$34.95

Bushmaster Barrels & Barrel Parts...

16" Carbine Chrome Lined Heavy Barrel Assembly... \$209.95 (Pre-Ban: A BBL-16A / Post-Ban: P BBL-16A)

Complete including all parts from upper receiver forward: barrel, gas tube, handguards, shields, delta ring kit, sight, etc. This barrel is available with bayonet lug and flash suppressor - for use only on Pre-Ban lowers - ask for details.



16" Carbine Heavy Assembly Barrel Only... \$185.00

(Pre-Ban: A BBL-16 / Post-Ban: P BBL-16)

Assembly less handguards, gas tube, delta ring kit and suppressor.

Bushmaster Superlight 16" Barrel Assembly... \$219.95 (Pre-Ban: A BBL-16SLA / Post-Ban: P BBL-16SLA) As requested by many of our customers, this is the lightest 16" barrel we've ever offered. Diameter is .625" from the chamber forward - similar to the original Vietnam era A1 barrel profile. Headspaced at the factory, and ready for assembly. Due to barrel diameter, Post-Ban versions will not accept currently manufactured muzzle brakes.



Superlight 16" Assy. - Barrel Only... \$195.00

(Pre-Ban: A BBL-16SL / Post-Ban: P BBL-16SL)

Assembly less handguards, gas tube, delta ring kit and suppressor.

16" Dissipator Heavy Barrel Assembly... \$229.95 (Pre-Ban: A BBL-16DA / Post-Ban: P BBL-16DA) A unique chrome lined barrel with full length, heat shielded handguards for improved cooling capability and the full sight radius designed into the A2 sight system. Includes all parts forward of the



Upper Receiver: handguards; delta ring kit, gas tube; front sight, etc. Barrels available with bayonet lug and flash suppressor - for use only on Pre-Ban lower receivers.

16" Dissipator Assembly Barrel Only... \$205.00

(Pre-Ban: A BBL-16D / Post-Ban: P BBL-16D)

Assembly less handguards, gas tube, delta ring kit, and flash suppressor.

Bushmaster "Dissipator M4" 16" Barrel Assembly... \$229.95 (Pre-Ban: A BBL-16DM4A / Post: P BBL-16DM4A) We've lightened our unique Dissipator barrel design by incorporating the M4 profile, and retained the benefit of the full sight radius. Already headspaced at the factory, this assembly includes all parts forward of the



Upper Receiver.

"Dissipator M4" Assembly - Barrel Only... \$205.00

(Pre-Ban: A BBL-16DM4 / Post-Ban: P BBL-16DM4)

Assy. less delta ring kit, handguards, gas tube. (On Pre-Bans, flash suppressor is not included.)

M16A2 Gov't. Type 20" Barrel Assemblies... \$219.95 (Post-Ban: P BBL-20A2A / Pre-Ban: A BBL-20A2A)

These Gov't. profile barrels - light in weight and reduced in diameter under the handguards are ideal for restoring that older Pre-Ban rifle or building a light weight Post-Ban. Pre-Ban versions include bayonet lug and A2 type birdcage flash suppressor, and are legal for use only on Pre-Ban



Lower Receivers.

Complete barrel

assemblies includes all parts from upper receiver forward (handguards, gas tube, delta ring kit, etc.)

M16A2 Gov't. Type 20" Barrel Only (below)... \$195.00

(Post-Ban: P BBL-20A2 / Pre-Ban: A BBL-20A2)



"Barrel Only" assemblies do not include handguards, gas tube, delta ring kit or flash suppressors (in Pre-Ban configurations).

Bushmaster Barrels & Barrel Parts...

20" National Match Heavy Barrel Assembly... \$209.95 (Pre-Ban: A BBL-20A / Post-Ban: P BBL-20A) Chrome lined in both bore and chamber, 1 x 9" button rifling and heavy profile, this barrel is the "standard" of our line. The complete assembly includes all parts forward of upper receiver: handguards; gas tube; delta ring kit, front sight, etc. all ready for assembly onto your Upper. Pre-Bans with bayonet lug and birdcage also available.



Available with a variety of optional factory installed muzzle brakes. See details on next pages.

20" National Match Heavy Assembly - Barrel Only... \$185.00
(Pre-Ban configuration: A BBL-20 / Post-Ban configuration: P BBL-20)



Pre-Ban Barrels with bayonet lug and flash suppressor can only be used on Pre-Ban lower receivers.

A chrome lined 20" barrel same as immediately above, but without the handguards, gas tube or delta ring kit (Pre-Ban configurations do not include flash suppressor). Ask your sales representative about factory installed muzzle brakes.

24" National Match Heavy Barrel Assembly... \$219.95 (Pre-Ban: A BBL-24A / Post-Ban: P BBL-24A) A 24" barrelled assembly with same chrome lining, full heavy configuration as the 20" National Match Heavy above with all parts from upper receiver forward.



24" Assy. "Barrel Only"... \$195.00

Same assembly without handguards, gas tube and delta ring kit. (Pre-Ban: A BBL-24 / Post-Ban: P BBL-24)

Bushmaster 20" Stainless Steel Barrel Assembly... \$259.95 (P BBL-20SSA) Many of our High Power Competition customers have asked for Stainless Steel Barrels, and Bushmaster now manufactures this superbly accurate 20" heavy barrel. Machined of highly polished 416 Stainless Steel, in 1 in 9" twist, this Barrel Assembly comes complete with front sight, sling loop, handguard set, gas tube, delta ring kit and barrel nut - all ready to install on your Upper Receiver.



20" Stainless Steel Assembly - Barrel Only... \$235.00

(P BBL-20SS) Save money on a Stainless Steel Barrel upgrade - use your existing handguards, gas tube and delta ring.

24" Varminter Extra Heavy Fluted Barrel... \$369.95
...the heart of our very successful and accurate "Varminter" Rifle.



(Part #: P BBL-24FVAR9A)

Like our DCM Competition Barrel, it is machined from the finest Chrome-Moly Vanadium Steel with a Manganese Phosphate finish, and unlike our standard barrels, it is not chrome lined. It features 1 x 9" button rifling; SAAMI Spec. chamber and bolt; extra heavy diameter (1" diam. out to the gas block); deep, lengthwise fluting; an 11° competition muzzle crown and milled V Match sight base/gas block. We recommend assembly onto your Upper by an experienced AR15 gunsmith. Includes barrel, complete bolt and gas block - shipped unassembled.

Bushmaster DCM Competition Heavy Barrel with Factory Matched Bolt and Front Sight Base...\$295.95 (9349054-20CGA) This lapped 20" Barrel, button rifled in 1 x 8 twist, features an 11° competition muzzle crown and SAAMI Spec. chamber. Machined from finest Chrome-Moly Vanadium Steel with a Manganese Phosphate finish, it is a full 1" diameter from the barrel extension forward to the sight base step. Shipped unassembled.

We recommend assembly by an experienced AR15 gunsmith.

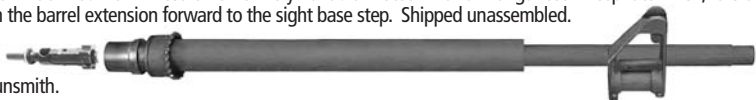

Bushmaster Barrels & Barrel Parts...

24" Stainless Varminter Barrel Assembly... \$309.95 (P BBL-24A-SS) A highly accurate 24" Barrel from our Stainless Varmint Special Rifle - polished 416 Stainless Steel, in 1 in 9" twist, this Barrel Assembly comes complete with vented aluminum freefloater forend set, sling stud, gas block, gas tube, and barrel extension. Shipped unassembled and ready for installation on your Upper.



24" Stainless Varminter "Barrel

Only" ... \$235.00 (P BBL-24SS) 24" Stainless Barrel with gas block, gas tube, and barrel extension

Bushmaster Barrel Parts... See Pages 40/41 for complete Schematic Parts Diagram

Gas Tubes... Quality materials and machining, properly bent for a perfect fit and flawless functioning in your rifle...

Gas Tube - RIFLE... (Standard) \$14.00 (Part # 8448567) / **Gas Tube - Carbine...** \$12.00 (Part # 1005-914-3504)

Gas Tube Pin... .40¢ (Part # MS16562-106)



A. B. Handguard Caps... \$5.95 each Manganese Phosphate finished steel in two different types for Standard or Heavy profile barrels...

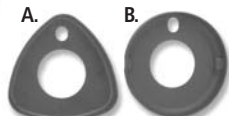

	For Standard Barrel	For Heavy Barrel
A. Triangular Handguard Cap...	(Part # SGW-10)	(Part # 9349053)
B. Round Handguard Cap...	(Part # SGW-09)	(Part # SGW-10F)

Delta Ring Kit... \$12.95 (8448712K) Includes aluminum delta ring, handguard weld spring, snap ring and gas tube pin.



Individual Parts...

- A. Aluminum Delta Ring... \$6.95** (8448712)
- B. Handguard Weld Spring... \$5.00** (8448555)
- C. Handguard Snap Ring... \$2.50** (MS16626-1137)
- D. Gas Tube Roll Pin... \$.40** (MS16562-106)

- A. Front Sling Swivel... \$2.95** (8448571)
- B. Front Sling Swivel Rivet... \$.75** (8448697)
- C. Barrel Extension... \$14.95** (9349054BE)
- D. Barrel Nut... \$11.95** (9349054BN)



Note: Bushmaster does not sell front sight bases separately due to the difficulties of drilling/fitting them to barrels.

Bushmaster Barrels for Uzis... The finest barrels you can buy for your Uzi - better than Israeli factory production. 9mm caliber - machined from Chrome Moly Vanadium barrel steel (Mil spec-s-11595) with Manganese Phosphate coating for rust protection. They are interchangeable in both semi- and full-auto UZI's, and are available with plain muzzles or threaded for the Mac Silencer Adapter (*T in Part # = threaded as shown on 7" & 10" barrels at right - \$5.00 additional).

- 4" Pistol Barrel... \$32.95** (BBLU4) / *\$37.95 (BBLU4T)
- 7" Pistol Barrel... \$39.95** (BBLU7) / *\$44.95 (BBLU7T)
- 10" Short SMG Barrel... \$46.95** (BBLU10) / *\$51.95 (BBLU10T)
- 16" Carbine Barrel... \$67.95** (BBLU16) / *\$72.95 (BBLU16T)
- 18" Carbine Barrel... \$71.95** (BBLU18) / *\$76.95 (BBLU18T)



Mac Adapter for Uzi Barrels ... \$10.95 (RAY-004) Allows installation of Mac silencer on Uzi threaded barrels. Internal threading for Uzi barrels 9/16 x 18 tpi - external Mac threading 3/4 x 10 tpi.



Uzi Barrel Shroud... \$44.95 (LE-200) For long barreled guns - easily installs as replacement for barrel nut. Heavy blued steel construction. Ventilated for maximum heat dissipation.



Ventilated Barrel Shroud/Handguard for Mini 14/Mini 30... \$12.95 (07-02-04) Molded of durable black polymer composite, this upper handguard snaps on easily to dissipate excess heat during rapid fire and reduce barrel whip. Fit either the Ruger Mini 14 or the Mini 30.



Ruger 10-22 Ventilated Barrel Shroud/Handguard... \$12.95 (07-02-02) Durable black composite, this guard snaps onto the barrel. Dissipates heat during rapid fire - extends barrel life - reduces barrel whip.



M1 Carbine Ventilated Barrel Shroud/Handguard... \$9.95 (CA20) A heavy blued steel guard to protect hands against barrel heat. An easy installation, simply snap it onto the M1 Carbine.



MUZZLE BRAKES / COMPENSATORS / FLASH SUPPRESSORS...

NOTE: BY THE GUN LEGISLATION OF 1994, IT IS ILLEGAL TO INSTALL A FLASH SUPPRESSOR ON A "POST-BAN" BARREL. FLASH SUPPRESSORS MAY ONLY BE USED WITH "PRE-BAN" LOWER RECEIVERS.

NEW from Bushmaster - The Izzy Brake... \$34.95 (Pre-Ban Part # IZ-102660-PRBF) or (Post-Ban Part # IZ-102660-PSTF) A new 5.56mm/.223 Caliber Muzzle Brake – designed by an employee here at Bushmaster – has now been production approved by the BATF. It features four gas ports and a machine turned ribbed design. It is manufactured of quality gun barrel steel with a manganese phosphate finish, and has proven to be very effective in controlling muzzle rise. Both a slip-on/pinned version for Post-Ban configurations, and the threaded model shown (for Pre-Ban or L.E. usage only), are available. 2 3/16" overall length.



Peel Washers / Crush Washers – For correct "timing" alignment of the gas ports on compensators and flash suppressors for any threaded Pre-Ban barrels, they must be installed with either a multi-layered Peel Washer or the newer design Crush Washer... **A2 Peel Washer... \$2.95** (9349052) or **A2 Crush Washer... \$2.50** (12991533B)

Y COMP and Mini Y COMP Muzzle Brake for POST-BAN Rifles... These highly effective compensators for the 5.56mm/.223 AR type rifle are CNC machined from quality bar stock steel - with manganese phosphate final finish. They slip over the muzzle on Post-ban AR's and are held in place with a steel taper pin. Drilling for the taper pin is required for installation. The Y Comp features three angled ports on each side for gas deflection, and adds 2 5/8" additional length to the Post-Ban barrel. The Mini Y Comp adds 1 3/4" additional length to the barrel and has two angled ports each side.

Note: Bushmaster will only warranty factory installations of these muzzle brakes. There is no charge for the installation of the brake if you buy it from us and have us install it.

Y COMP Muzzle Brake... \$45.95 (YHM-258P) or **Mini-Y COMP Muzzle Brake... \$29.95** (YHM-259P)



Y COMP and Mini Y COMP Muzzle Brake for PRE-BAN Rifles... Similar to the Post-Ban models above, these 5.56mm/.223 compensators are threaded to fit Pre-Ban AR barrels. The Y Comp overall length is 3 1/4" - the Mini Y Comp is 2 5/16" overall length. **Order either a Crush Washer or Peel Washer for installation (see above).**

Note: These muzzle brakes are for use on Pre-Ban threaded muzzle barrels only.

Y COMP Muzzle Brake... \$45.95 (YHM-258) or **Mini-Y COMP Muzzle Brake... \$29.95** (YHM-259)



Russian Design AK74 Muzzle Brake for Post-Ban AR15 Type Rifles/Carbines... \$25.95 (MMT-0012PB)

This brake - thought to be originally an American design - is a .223 caliber copy of the Russian Military brake found standard on the AK74 Assault Rifle. It is designed to reduce felt recoil by 70% and reduces muzzle rise by 90%. Muzzle climb is controlled by directing gas upward through three gas ports. Recoil is diminished by four ports which direct gas away at a 45° angle from the weapon, and a contoured flat at the end of the brake directs gas sideways. The two gas streams cancel each other and absorb the force of recoil. 3" overall length. **Note: A taper pin is included. This brake requires drilling for the taper pin and should be factory installed, or should be installed by a qualified gunsmith.**



AK74 Type Muzzle Brake for Pre-Ban Rifles... \$25.95 (MMT-0012A) Much like the Post-Ban model above, but this version screws onto Pre-ban (threaded muzzle) barrels and locks in place of the flash hider. A peel washer is included with this brake for correct timing during installation. An Allen head set screw locks the brake onto the threaded muzzle after timing. 3" overall length. **Fits only Pre-ban threaded muzzle barrels.**



MUZZLE BRAKES / COMPENSATORS / FLASH SUPPRESSORS...

5.5" AK74 Muzzle Brake for Carbines ... \$29.95 (MMT-0013) An excellent and very functional muzzle brake for the short barreled carbines. It's 5.5" overall length, when permanently installed on the 11.5" barrel, makes a legal 16" barrel length. It reduces felt recoil by 70% and muzzle climb by 90%. A peel washer is included for proper "timing" (positioning of the brake on the muzzle).



A2 Bird Cage Flash Hider... \$5.95 (9349051) The military standard 5 slot design for threaded muzzle Pre-Ban barrels (shown right). There are no bottom slots so it won't create a "dust signature" when firing from the prone position. Order a Peel Washer or Crush Washer for correct installation timing (see below).

A1 Bird Cage Flash Hider... \$5.95 (8448576) This original design, from the Viet Nam era, is slotted all around and therefore does not require specific slot timing during installation (use the **A1 Flash Hider Lock Washer** below).

A1 Flash Hider Lock Washer... .50¢ (8448577)

A2 Peel Washer... \$2.95 (9349052) For correctly timing (position of slot or gas ports) of suppressors or brakes when installing on Pre-Ban threaded muzzle barrels.

A2 "Crush" Washer... \$2.50 (12991533B) Replaces a peel washer for timing muzzle brake and suppressor installations (one time use only).



Phantom Flash Suppressor... \$34.95 (YHM-29) Precision CNC machined from quality gun steel and phosphate coated to military standards, the five gas slot Phantom Suppressor eliminates all flash and offers excellent performance with night vision equipment. This newer Phantom design offers strength far superior to the earlier forked type suppressor, and it won't "hang up" on brush or clothing. Overall length is 2 3/16" - use a flash hider lock washer when installing. **For Pre-Ban threaded muzzle barrels only.**

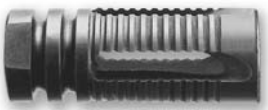

3 Versions of our CAR 15 Flash Suppressor... All top quality, manufactured in the U.S.A. The five slot design makes these very effective suppressors for your short barreled carbine.

Available for Pre-Ban threaded barrels only. Choose from:

(A) CAR 15 Extended Flash Suppressor... \$14.95 (MMT-500)
5.5" overall length - threaded for all Pre-Ban barrels.

(B) Shorty Look Slipover Flash Suppressor...

Internal threads allow installation onto barrel - giving your gun a "shorty" look without sacrificing accuracy 5" overall length.

For Standard Diameter (.610") Barrels... \$14.95 (MMT-0019)

For Heavy Diameter (.720") Barrels... \$19.95 (93495FSH)

(C) CAR 15 "Original" Flash Suppressor... \$14.95 (1005-914-3902)

This is the original 4.5" M177 carbine design.

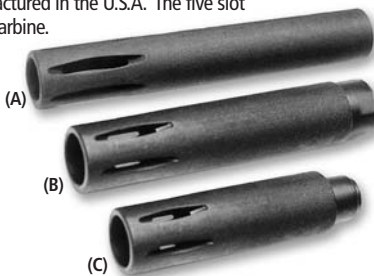

Gov't. Issue Type Blank Firing Adapter... \$14.95

(RAY-008) This device allows the AR15 type gas system to function with blank ammo. Made of heavy steel with a finish of bright red paint for safety. This assembly fits over the standard A2 birdcage flash suppressor.

WARNING!

Remove This Adapter BEFORE Firing Live Ammo!



Shoot-Away Muzzle Cap (RCL-10) .40¢ A red plastic muzzle cap designed to slip over AR15 Barrels. Keeps out dirt and moisture, but can be shot through safely.

Birdcage Type Flash Suppressor for AK's... \$9.95

(RAY-009) Like the A1 birdcage, this suppressor is slotted all around for excellent flash control - threaded left-hand metric (14 x 1) for easy installation on any Pre-Ban AK barrel with threaded muzzle.



Muzzle Brake for AK's... \$34.95 (MMT-0015A) A precision machined brake in 7.62 x 39 caliber for installation on Pre-Ban AK47 barrels. This has a metric left hand thread (14 x 1.25), and looks like the latest Russian AK74 design. Effectively reduces muzzle climb and absorbs recoil. Finished in black manganese phosphate.



REMEMBER: BY THE GUN LEGISLATION OF 1994, IT IS ILLEGAL TO INSTALL A FLASH SUPPRESSOR ON A "POST-BAN" BARREL. FLASH SUPPRESSORS MAY ONLY BE USED WITH "PRE-BAN" LOWER RECEIVERS.

MUZZLE BRAKES / FLASH SUPPRESSORS FOR RUGER MINI 14 & MINI 30...

Mini 14 "Birdcage" Flash Suppressor / Front Sights...

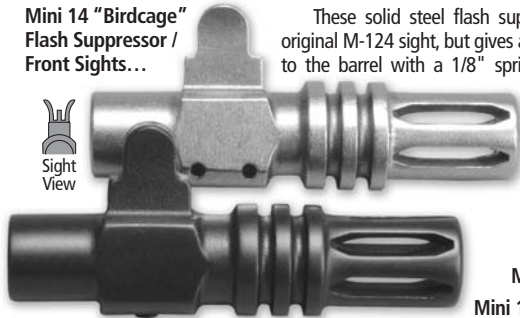

These solid steel flash suppressors include a front sight that looks like the original M-124 sight, but gives a much better sight picture. They attach permanently to the barrel with a 1/8" spring steel roll pin (included) like the original sight.

Complete instructions are included - a simple installation for any gunsmith. The suppressor's lower slots have been omitted to avoid kicking up dust with muzzle blast when you're shooting prone position. The muzzle end is enclosed to prevent snagging on underbrush. Available in Blued or Stainless Steel.

Mini 14 Suppressor/Sight - Blued \$44.95 (7-07-12)

Mini 14 Suppressor/Sight - Stls. Steel \$47.95 (07-07-13)

AK74 Type Muzzle Brake for Mini 14... \$29.95 (MMT-0018) A .223 caliber copy of the Russian Military brake from their AK74 - it slips on around front sight and pins in place (roll pin included). Muzzle climb is reduced by directing gas upward through three vertical gas ports. Recoil is diminished by four



45° ports directing gas away from the weapon, and a contoured flat at the end of the brake directs gas sideways. The two gas streams cancel each other and the force of recoil is absorbed as the brake redirects the gas pressure. Phosphate finished steel.

Mini 30 Slip-on Flash Suppressors... These heavy duty suppressors lock securely in place around the rifle's front sight (requires removal of front sight pin, new pin included) and hides flash while it reduces muzzle jump. Machined from Blued Steel or Stainless Steel.

Mini 30 Slip-on Flash Suppressor - Blued... \$29.95 (RM30)

Mini 30 Slip-on Flash Suppressor - Stainless... \$34.95 (RM30N)



OTHER RUGER MINI 14 / MINI 30 / 10-22 Parts...

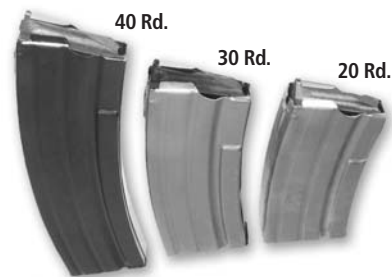

**Ruger 10-22
Factory 10 Rd.
Magazine...
\$17.95 (2213)**



**Ruger 10-22
Extended
Mag. Catch...
\$7.95 (2207)**



**Mini 14
Stripper
Clip
Guide...
\$6.95
(1408)**



Mini 14 Steel Magazines... Quality steel magazines guaranteed for reliability, functionality and durability. Quantities are limited - order now to ensure availability.

- 20 Round - Blued... \$14.95 (MG-0093)
- 20 Round - Nickel Finish... \$31.90 (MG-0197)
- 30 Round - Blued... \$19.95 (MG-0094)
- 30 Round - Nickel Finish... \$29.95 (MG-0198)
- 40 Round - Blued... \$29.95 (MG-0095)
- 40 Round - Nickel Finish... \$34.95 (MG-0199)

Muzzle Brake for SKS... \$14.95 (SKSHP-02) Reduces muzzle climb and recoil, allowing for rapid fire with minimal sight deviation. This muzzle brake is designed to replace the front sight, with a secure fit that won't shoot loose.



DISASSEMBLY VIEWS BUSHMASTER XM15 E2S RIFLE

BARREL, HANDGUARD and FRONT SIGHT COMPONENTS IN THIS DISASSEMBLY GROUP

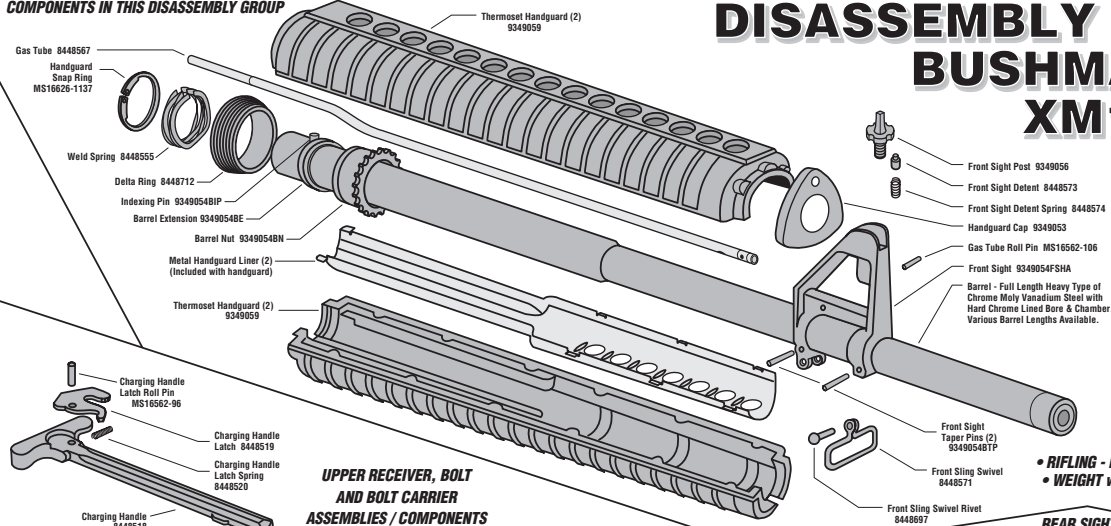

- CALIBER: Chambered for NATO 5.56mm. Also accepts .223 REM.
- MODE OF FIRE: SAFE / SEMI-AUTOMATIC
- 10 ROUND MAGAZINE
- 39.25" LENGTH OVERALL
- 20" BARREL LENGTH
- RIFLING - RIGHT HAND TWIST - 1 IN 9"
- WEIGHT w/o MAG. - 7.5 LBS. (3.4 KG)

UPPER RECEIVER, BOLT AND BOLT CARRIER ASSEMBLIES / COMPONENTS

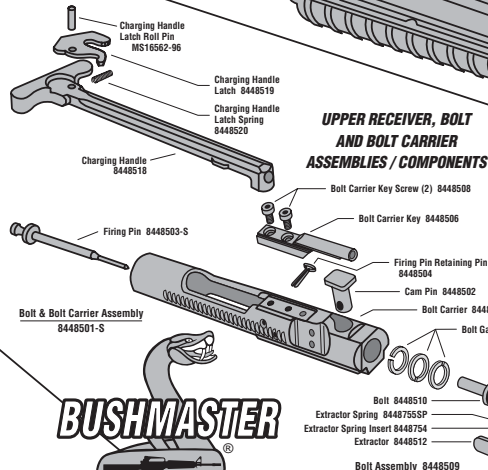

UPPER RECEIVER, BOLT, BOLT CARRIER, and CHARGING HANDLE and COMPONENTS IN THIS DISASSEMBLY GROUP



REAR SIGHT ASSEMBLY / COMPONENTS

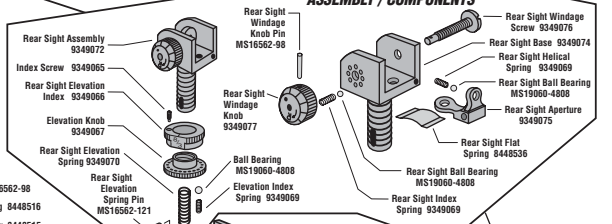

REAR SIGHT COMPONENTS IN THIS DISASSEMBLY GROUP

- Caliber 5.56mm .223 Rem.
- Mode of Fire: Semi-Automatic
- 10 Round Magazine
- 39.25" Length Overall
- 20" Barrel Length
- Rifling - Right Hand Twist - 1 in 9"
- Weight w/o Magazine 8.2 Lbs. (3.72 kg)



LOWER RECEIVER, PISTOL GRIP, BUTTSTOCK and MAGAZINE COMPONENTS IN THIS DISASSEMBLY GROUP

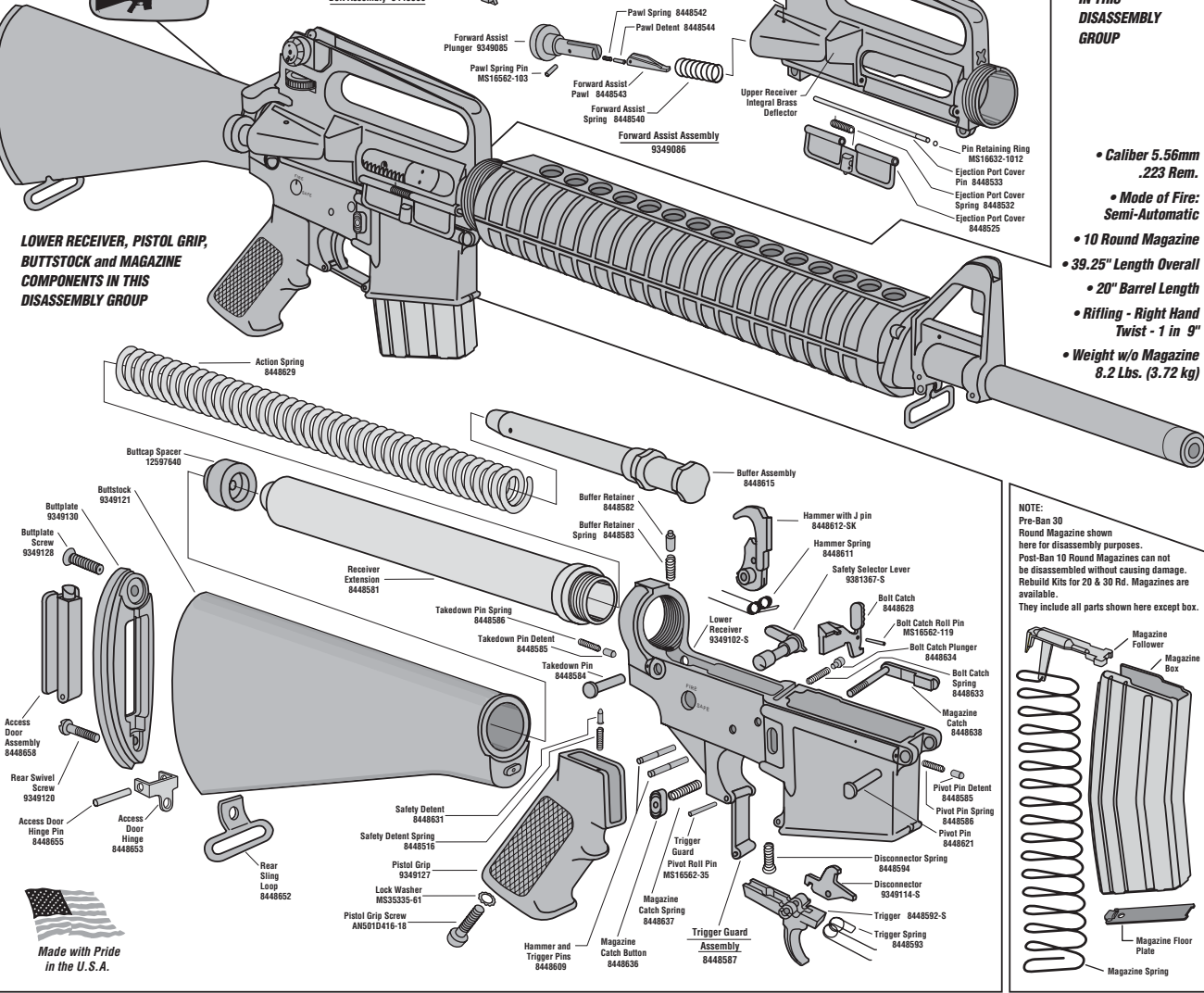

NOTE: Pre-Ban 30 Round Magazine shown here for disassembly purposes. Post-Ban 10 Round Magazines can not be disassembled without causing damage. Rebuild Kits for 20 & 30 Rd. Magazines are available. They include all parts shown here except box.



XM15 E2S "DISASSEMBLY VIEWS" POSTER - printed in a multi-color 18" x 28" size on 100# glossy stock. Great Framed! (QP-010) \$4.95 plus shipping

MAGAZINES & MAGAZINE ACCESSORIES...

Bushmaster 10 Round Magazine... \$14.95 (8448670-10) This Bushmaster manufactured magazine is top quality - exactly what we ship with all our new rifles. After extensive testing and development, it was approved for production by the BATF and meets their strictest requirements for the 10 Round Capacity legal limitation. We guarantee this magazine will provide excellent fit and function in all AR15 type rifles. It features mil. spec. manufactured components including a hard anodized aluminum box with a baked Teflon finish; standard green AR follower, and the Bushmaster Snake Logo molded into the base. This heavy black plastic base takes wear and tear but absolutely limits capacity to 10 rounds for legal compliance.

Note: Due to BATF's requirements, this magazine cannot be disassembled. Any attempt to do so will destroy the magazine. If the magazine gets dirty, it can be cleaned with a strong detergent/hot water solution. Then blow dry with compressed air while depressing the follower and spring. Relubricate as soon as it is dry.

Bushmaster 5 Round Magazine... \$19.95 (8448670-5) Similar to the 10 Round magazine at right but blocked to 5 rounds for hunting use (laws in many States limit magazine capacity to 5 rounds for hunting).



Bushmaster High Cap. Law Enforcement Magazines...

Post-Ban 20 and 30 round magazines are available to Law Enforcement Agencies and Departments, or for export only.

Qualifications for sale include a certification letter and purchase order. Contact our Law Enforcement Sales Department for details.



Bushmaster Magazine Rebuild Kits...

All Mil. Spec. parts to refresh your tired magazines - including New Spring, New Green Follower and Bushmaster Baseplate - use your own magazine bodies.

20 Rd. Mag. Rebuild Kit... \$5.95 (8448670-20K)

30 Rd. Mag. Rebuild Kit... \$5.95 (8448670-30K)

Bullpup M17S Magazine... \$14.95 (30-452) This quality, steel, 10 round magazine - made in the U.S.A. - has a black finish and black follower. Works great in the Bushmaster M17S Bullpup, but can be used in all AR type rifles - and its accepted for High Power Competition match use by the Civilian Marksmanship Program and National Rifle Association.



Bushmaster Green Magazine Followers...

20 Rd.

30 Rd.

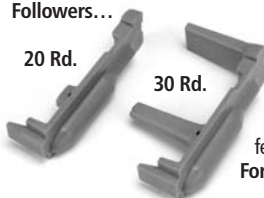

New, green plastic replacement parts to help your magazines feed and function better.

For 30 Rd. Magazines... \$1.75 (8448672)

For 20 Round Magazines... \$1.75 (8448672-20)

Blued Steel 40 Round Magazine

for AR15/M16... \$24.95 (MG-0007) Gloss black finish box with standard green follower.



Stripper Clip Guides...

Stamped steel with phosphate finish.95¢ ea. (EGSS-02)



Stripper Clip...

.30¢ ea. (EGSS-01)

Stripper Clips... in quantities of 25 or more. .25¢ each



Bushmaster Magazine Springs...

Highest quality steel tempered for long "memory" and positive feed. **20 Round - \$3.50** (8448671-20) **30 Round - \$3.50** (8448671)



Three Magazine Pouch...

Cordura nylon construction featuring a silent clasp, suspension ring, and two belt clips. (Mags are not included.)

Black... \$15.95 (6451)

Olive Drab... \$15.95 (6452)



MAGAZINES & MAGAZINE ACCESSORIES...

Mag-Lock - For all AR15 / M16's... \$14.95 (PAI-1)



This unique device looks like an AR15/M16 magazine, but is actually a safety lock. Insert it into the magazine well, lock it, (supplied with two keys) and it completely secures and disables the rifle. The Mag-Lock cannot then be removed - the bolt cannot be pulled back - the chamber is sealed - and the rifle cannot be fired. But once the Mag-Lock is unlocked, the device drops out like any magazine and you are ready for function. Makes a great gift for any AR owner, and a valuable security addition for the home!



"ShotLock" Cable Lock for AR15 / M16 \$7.95 (SLC3000)

This 13" cable system will ensure the safe storage of your rifle. It locks through the open ejection port and mag. well, and its vinyl covered cable prevents damage to finishes - useful on a variety of other rifles and pistols as well.

The Mag-Pull... \$9.95 / Set of 3 (MP-3)

A unique AR15/M16 magazine accessory developed from infantryman's ingenuity and the need to make fast magazine changes. GI's applied loops of duct tape or paracord to the bottom of the magazines to speed magazine interchange and to deaden the sound of mags in a storage pouch. This modern, molded black rubber Mag-Pull improves upon the original concept with rough exterior texturing for positive grip, a semi-rigid finger loop for fast removal, and a snug fit for all AR type mags. Sold in packs of three.



Buttstock Mag Pouches for the AR15... Strap on an extra magazine with these heavy duty pouches - models for either the full A2 buttstock or the CAR Telescoping stock. Black nylon webbing construction for durability and velcro straps for easy installation and removal.

A2 Trapdoor Buttstock Magazine Pouch... \$29.95 (TTMP)

Telescope Magazine Pouch... \$29.95 (TTTS)

(Magazines not included)



The EasyLoader... \$39.95 (8448670-EL223)

The EasyLoader - for Stripper Clips... \$39.95

(8448670-EL223SC) The EasyLoader works slick as a zipper! A pull of the handle loads all sizes of AR Magazines (and other .223 cal. magazines as well). The larger model (8448670-EL223) is designed for loose ammo - just drop the rounds in, close the cover and pull the slide. The smaller model (8448670-EL223SC) handles ammo that is already loaded in Stripper Clips. We started using them here at the factory, and found they save lots of time. Made in the U.S.A.



Model for
use with
loose ammunition.

Model for
use with
Stripper Clips.

The "L.U.L.A." Mag Tool... \$23.99

(Part # 8448670-LULA) L.U.L.A. is a

"Loader/Un-Loader Accessory" that will load a 30 rounder in about 35 seconds, and unload it in 5! With that speed, they've become very popular in the Bushmaster shooting room - and they're used by the Israeli Military as well. Fits all capacity AR/M16 type magazines including Thermolds and Orlites.



MAGAZINES & MAGAZINE ACCESSORIES...

Universal Magazine Tool... \$5.95 (UMT) A pocket sized tool that will load or unload any magazine on the market today - includes a key chain and instructions for use. Molded of heavy black plastic.



AR15/M16 Magazine Connector \$22.95 (51-08-01) Hold twice the ammo with this side by side magazine clamp - fits both 20 and 30 round mags. When you empty one magazine, drop them out, move over to the full one, and quickly reinsert. Made of heavy steel with flat black finish. Screw slot is sized for use with a coin. Works with AR 180 magazines as well.

(Magazines not included.)

First Samco Magazine Coupler... \$10.99 (FBS-MCUP1)

This plastic magazine coupler firmly joins two 30 rd. magazines. Molded of black plastic with steel clamping screws.



(Magazines not included.)



Triple Magazine Connector... \$24.95 (BC-100) Clamp three 30 rd. magazines together in this solid, black anodized aluminum mount to give you 90 rounds total. Clamps bolt together with Allen head screws.

(Magazines not included.)

AR15/M16 Magazine Dust Covers... \$6.95 (ATI15223) See-thru, flexible, molded rubber caps that snap over the magazine top to keep out dust and water. Sold in sets of four, designed to fit all standard AR15/M16 metal magazines.



AR Magazine Speedloader... > \$19.95 (2693829) A fast, belt mounted magazine loader - just insert any AR15/M16 magazine and push down a stripper clip of ammo from the top, and the magazine is loaded. Push the release button, the magazine drops out. Includes two stripper clips and a special mag. unloading tool - fits 2" wide belts.

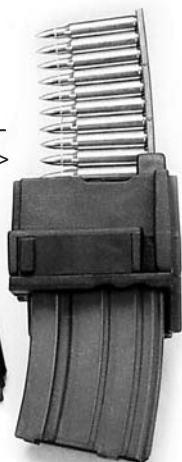

AR15/M16 Mag Grip for 20 or 30 Rd. Magazines... \$21.95 (MG-01) A heavy duty, black anodized aluminum dual clamp and screw kit designed to join both 20 and 30 round magazines. Offers the operator fast tactical reloads. Includes Allen wrench and instructions.

(Magazines not included.)

Redi-Mag Model A1... \$69.95 (RM-15A1)

with Bolt Release Button...

Carry your spare magazine and make quick swaps from an empty one to a full one. Just drop them out, move the fresh one over, and push the bolt release button to resume firing. Redi-Mag is made of sturdy steel and is finished to match your rifle.

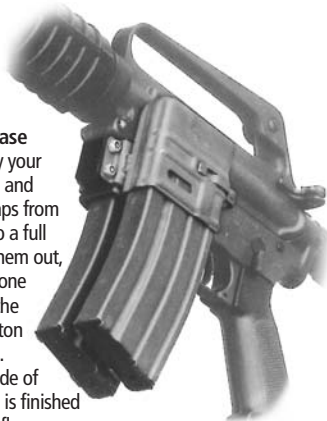

(Magazines not included.)

AK47 Magazine Dust Covers... \$6.95 (ATI0762) Specifically molded to fit AK magazines - similar to AR type shown at left. Sold in sets of four.

MAGAZINES & MAGAZINE ACCESSORIES...

These shell case defectors snap onto various AR15 models to keep hot brass away from your face and away from other competitors on the firing line. This product should be particularly appealing to left handers who've experienced "hot brass in the face"! These defectors will drop all the cases in the same place at your feet (very convenient for reloaders), and are allowed under NRA High Power Competition Rules. See below for models for A2's, Flat-tops, and the A3 Removable Carry Handle. **A. For A2 fixed Carry Handle... \$20.99** (Part # BD-A2)

B. For A3 flat-tops... \$20.99 (Part # BD-A3-flattop) / **C. For A3 Removable Handle... \$20.99** (Part # BD-A3 Handle)



Bag Style Brass Catcher... \$39.95 (2693828) A flexible black, Cordura nylon bag with an internal frame and a zippered opening on the underside for easy emptying of shell cases.

A 2" wide velcro strap wraps around the handguard to hold the bag and frame in place so that it fits flat-top and other AR15 type rifles.



Rigid Style Brass Catchers for the AR15/M16 and other Rifles... These hard plastic brass catchers hold a minimum of 60 casings. Molded of black, nylon reinforced plastic, they snap on and off your rifle easily.

Models available to fit various rifles - see listings at left.



For AR15/M16 Rifles & Carbines...

- For A2 Fixed Handle Rifles (upper photo)... **\$34.95** (EL-AR-001)
- For "Flat-top" Rifles without A3 Type Removable Carry Handle (lower right photo)... **\$34.95** (EL-AR-002)
- For Ruger Mini 14... (EL-M-14-001) **\$34.95**
- For Ruger Mini 30 & Ranch Model... (EL-M-30-001) **\$34.95**



- For .30 Cal. Carbine... **\$34.95** (EL-30-CAR-01)
- For AK47 Rifles... **\$34.95** (EL-AK-47-1)
- For FN-FAL/FNC... **\$34.95** (EL-FN-FAL-001)

M1 Carbine Jungle Clip... \$7.25 >

(MG-0183) Holds two 30-round magazines in side-by-side configuration under spring pressure. Heavy gauge blued steel clip - weighs 2.5 oz. (Magazines not included)



< Uzi 9mm Magazines for Carbine and Pistol...

32 Round... Blued Steel, shown in left photo. \$33.90 (UZI MAG 32)

25 Round... Steel with a Green Finish, shown in right photo. Has four numbered inspection holes marked 10 / 15 / 20 / 25 rounds. \$29.95 (UZI100)



< M1 Carbine Magazines...
30 Round... Blued Steel \$24.95 (SCH-004)
10 Round... Blued Steel \$12.95 (SCH-007)



FN 20 Round Magazine > \$19.95 (MAT-004)
 New, genuine FAL magazines.

Original Steel FN Magazine Loader (below) \$7.95(MAT-001)



AK Magazines... All 7.62 x 39mm < 30 Round... \$29.95 (100-005A)



< 5 Round \$10.95 (100-008A)

AK-47 Stripper Clip Guide... \$5.95 (100-001)



PISTOL GRIPS & BUTTSTOCKS...

A2 Standard Pistol Grip...

\$11.95 (9349127) Standard issue A2 hollow pistol grip of molded black plastic - features raised finger ridges, checkered panels and a ribbed backstrap.

Grip Screw & Washer .95¢

(AN501D416-18 and MS35335-61)



Pistol Grip Plug...

\$3.95 (SCH-5) Turns any standard A2 pistol grip into a

"stowaway" type for storage of small items. Molded of black rubber, it is a snug friction fit inside the grip cavity.

Hogue AR15/M16 Pistol Grip... \$29.95

(15000) We use this comfortable, ambidextrous, textured rubber grip on our Varminter. Its an easy, one screw installation on your AR15/M16 (don't lose the safety detent or spring when changing over).

Hogue also offers companion free-floater forends (see Handguards section).

Pistol Grip only \$29.95 (15000)

Rifle Forend only \$74.95 (15002)

2 Piece Set... (Grip and Forend)

For Rifle \$99.95 (15003)

For Carbine \$99.95 (15013)

Carbine Forend only...

(Includes special gas tube) \$74.95 (15004)

First Samco Tactical Stow Grip...\$23.99

(FBS-G27) This comfortable new ambidextrous "G27" grip is molded from a synthetic material proven to minimize slippage even when wet. An extended beavertail and finger ridges provide excellent control, and a coin locking insert seals the internal storage compartment.

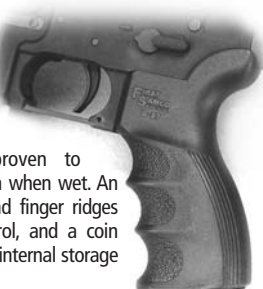

ErgoGrip Vertical Forend...

\$49.95 (ARG-FWD)

Mounts to all Picatinny rail and Weaver base type forends, this ergonomically designed forearm grip offers comfort and fire control. An aluminum mount block and its hex nut clamp the handle solidly onto the rail.



See the Bushmaster Modular Accessories System section of this catalog for additional accessories

HK91 Style Cushioned Sure-Grip for AR15/M16... \$24.95

(ARG-AMBISOFT) A pebble grained, contoured, cushioned urethane composite grip with finger grooves, palm swell and beavertail for control and comfort. Improves trigger finger placement to aid accuracy. Installs easily - new grip screw and plate included.

Also available... Sure Grip Plug

Makes this grip a "stowaway" type. >

\$4.95 (ARG4335)



AR15/M16 Tactical Grip... \$59.95

(ARG01) The ultimate tactical grip for the AR15, this adjustable palm swell style grip adapts easily to different sized hands and puts pressure in the palm of the hand to allow a deliberate and calculated trigger pull.

Molded of heavy black plastic, it installs easily on any AR15/M16.

Pachmayr "Vindicator" Grip... \$36.95

(04173) An ergonomically designed, hard rubber grip for the AR15 with a solid feel, fine checkering and finger grooves for excellent control and comfort. Non-slip even when wet. Installs easily with a long 3/16's Allen Wrench (not included).

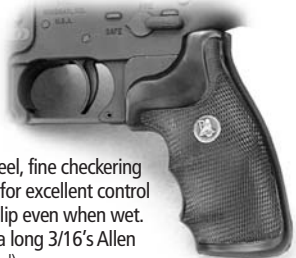

AR15/M16A2 Stowaway Grip... \$12.95

(56PT87SPG2)

This M16A2 configuration grip - with a serrated backstrap and finger groove - features a trap door storage compartment for cleaning gear or small parts.



The "Gapper" ... \$3.49 (SCH4085) Fills that blister causing void between the pistol grip and the back of the trigger guard - molded of flexible black polyurethane. Fits snugly, or can be glued in place. Greatly increases grip com-fort (shown separately, and installed).



PISTOL GRIPS & BUTTSTOCKS...

Forward Combat Grip... Mounts beneath the front sight to offer solid control of muzzle rise in rapid fire. Use on any rifle or carbine that has an unobstructed section of barrel for clamp-on attachment. For AR rifles, **Specify if for Forward Combat Grip for Standard or Heavy AR Barrel...**

Model with A2 Std. Pistol Grip... \$19.95
Standard Barrel [.610"]... (FWD GRIP-S)

Heavy Barrel [.720"]... (FWD GRIP-H)

Model with Stowaway Grip... \$26.95

Standard Barrel [.610"]... (FWD GRIP-WS-S)

Heavy Barrel [.720"]... (FWD GRIP-WS-H)



AR15/M16 Skeleton Stock... \$105.95

(Part #: SKELETON STOCK) This new stock represents a radically different approach to AR stock design. A comfortable neoprene foam sleeve and the stock's skeleton frame slide right on to the existing buffer tube of your rifle, and then clamp tight with a new buttplate screw and the skeleton frame screws. A comfortable rubber buttplate is included, and a quick detach sling swivel can be mounted forward left, or right, or on the bottom of the buttplate. This is a solid and functional addition for any AR - especially the carbines. Length 10.5" / Weight 14.03 oz. (Does not include buffer tube, buffer or spring - use already existing parts or buy kit below).



Skeleton Stock Kit for Changeover from a Tealstock... \$144.95 (SKELETON-STOCK-K) The Skeleton Stock is also available as a kit for those wishing to swap over from a tealstock. The Kit includes Skeleton Stock with Buttpad and Hardware (as above) plus a standard AR buffer tube, standard buffer and spring.



Replacement Foam Sleeves for Skeleton Stocks...

For Standard Length model above... **\$3.99 (SKEL-FOAM-OT-8.2)**, or for the Shorter Skeleton Stock shown at right **\$3.69 (SKEL-FOAM-OT-5.5)** Note: Installs easier with WD40.

Pistol Grips & Buttstocks

See the Bushmaster Modular Accessories System section of this catalog for additional accessories

Complete A2 Trapdoor Buttstock Assembly \$74.95 (A2 STK COMP)



The newer A2 design is 5/8" longer than the original A1 type for greater shooting comfort and a correct trigger pull length of 13.5". A convenient trapdoor storage space in the buttstock provides room for spare parts or a cleaning kit (see our Gunsmithing Section). This complete assembly includes buttstock with trapdoor buttplate, sling loop, buffer, buffer tube, buffer spring, spacer and vented buttplate screw.

Bushmaster Stubby Stock... \$64.95

(9349119-S-KIT)

This version of the standard A2 buttstock (3.25" shorter) makes the AR type rifle easier to carry in confined quarters as it is not much longer than a compressed tealstock. It's just long enough to be legal length with 16" barreled guns, and is also sized well for women and younger shooters. Comes complete with carbine length Buffer and Spring. A standard rear sling loop is mounted, and the solid buttplate (no trapdoor storage compartment) is smooth and comfortable on the shoulder. Length 7.25 inches / Weight 14.6 oz.



Shorty Skeleton Stock Kit including CAR Buffer and Spring... \$139.95 (SKEL-SH-STK-KIT)

This kit has all the features of the original Skeleton Stock in an overall length of 7 3/4" when installed. It weighs only 12.8 oz. The neoprene sleeve around the buffer tube offers a comfortable cheek weld. A 1/2" rubber recoil pad, a quick detach sling swivel (mounts on either left or right side, or on the buttplate base), a short Buffer Tube, a CAR Buffer and Spring, and all necessary screws are included for an easy swapover from any AR type rifle or carbine.



For those who already own the CAR Buffer and Spring, we offer the **Shorty Skeleton Stock** without those parts at **\$126.95 (SKEL-SH-STK)**.

PISTOL GRIPS & BUTTSTOCKS...

Skeleton Stock Extended Recoil Pad... (SKEL-1IN-BUTTPAD) \$12.95

This molded rubber Recoil Pad fits all the Skeleton Stocks including the new Shorty Model. It's one inch thickness adds extra shooting comfort - especially helpful for the larger shooter who needs a bit of extra trigger pull length. Installs easily in place of existing pad - screws are included. Weight 3.2 oz.



Complete Bushmaster Lower Receiver with

FFL Required for Purchase

Skeleton Stock... \$329.95 (Part # A LOW SKELETON) OR, Lower w. Stubby Stock... \$229.95 (A LOW STUBBY)

Rubber TeleStock Butt Pads... These molded rubber pads securely fit the buttplate of the telestock to offer comfort and a positive shouldering position.

Models available for new or old type telestocks... A) For new "ribbed" style telestocks - also fits all the new Carbon 15 Rifles...

\$18.95 (Part # 2698828)

(B) For old style Telestock...

\$15.95 (Part # 2698827)

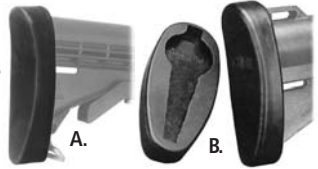

Extended Buttplate for AR15/M16... \$21.95 (16-09-02)

This glass-filled, black plastic composite buttplate adds 1 3/4" length to the standard issue AR15/M16 buttstock. It replaces existing buttplate using the same screws. It does however block access to the buttplate trapdoor.



Complete Fixed Position Tele-Style Stock Assembly... \$99.95 (1005-087-8988PEK)



This Tele-style stock from Bushmaster gives your post-ban carbine the military look. Because it is permanently fixed in an "extended" position, BATF has approved its use on Post-Ban Lower Receivers. It puts your carbine on target quickly, and its full length A2 Buffer Tube, Buffer and Spring will cycle your action reliably! The ribbed body is molded of tough black composite plastic and the whole assembly weighs approximately 1/10th lb. less than a standard A2 buttstock assembly. It includes a sling loop in the standard position, and a slot for alternate "top" mounting slings. All hardware is included for installation on your carbine. We recommend the use of one of our telestock wrenches for installation on the receiver extension - see our Gunsmithing Tools section.

Six Position Fiberite Telescoping Stock Assembly for Pre-Bans... \$99.95 (1005-087-8988-PK)

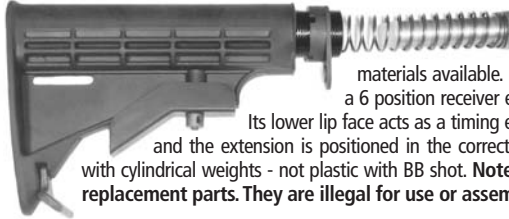

This new design - now upgraded with a 6 position telescoping assembly - is made of the toughest materials available. It features a new ribbed style body for extra strength, a 6 position receiver extension machined from a solid aluminum extrusion. Its lower lip face acts as a timing edge to insure that the buffer retainer is held correctly and the extension is positioned in the correct location. It includes an original design metal buffer with cylindrical weights - not plastic with BB shot. **Note: Functional Telescoping Stocks are sold only as replacement parts. They are illegal for use or assembly on new "Post-Ban" weapons**

Original Style Fiberite TeleStock Assembly for Pre-Bans... \$99.95 (ALEO-001K)

For those preferring the original style fiberite telestock body, we offer this assembly. It has the original 4 position telescoping aluminum extrusion extension tube, and includes an original design metal telestock buffer with cylindrical weights, and the carbine length buffer spring. Always use a telestock assembly wrench for tightening this assembly onto your lower - available in our Gunsmithing Section.



Remember: Telescoping Stocks are sold only as replacement parts for existing "Pre-Ban" rifles. They are illegal for use or assembly on new "Post-Ban" weapons.

PISTOL GRIPS & BUTTSTOCKS...



TeleStock Cheekpiece... \$34.95 (7000) This quality telestock cheekpiece allows the use of scope, laser, or night vision devices with comfort. Molded of tough black plastic, it snaps on to most older style fiberite telestocks with a secure pressure fit. Featuring a built-in watertight storage compartment (see screw-in type cap at top rear of the unit). This assembly will help take all the "rattle" out of fiberite telestocks. **Note: For use on Fiberite Telestocks only. This model only fits original type telestocks (as shown here).**

New Style TeleStock Cheekpiece... \$34.95 (7200) A new model cheekpiece, while similar to the one pictured, has been designed to fit the new "ribbed body" telestocks (like our new 6 position style above). It has the same quality features and storage compartment.

Delta Style Stock Cheekpiece... \$69.95 (6200) A quality addition for your A2 buttstock designed to improve accuracy by eliminating parallax problems. It shoulders easily and provides the proper cheekweld for telescopic sight use. Installs securely with no alteration to original butt cap or sling loop, and is designed specifically for the new style A2 stock (though it can be modified to fit the A1). Made in the U.S.A. and constructed of durable black polypropylene.



Delta-Pro Cheekpiece... \$74.95 (6600) A tough, light weight (6.6 oz.), black polypropylene, snap-on cheekpiece for the A2 buttstock, this unit installs easily and includes a watertight, o-ring sealed storage compartment for small parts. It locks in place onto the A2 stock with a small tab that replaces the original sling loop (a new sling loop is included). Made in the U.S.A.

"Hook" Style Buttstock for AR15/M16... \$41.95 (16-01-02) With one inch additional length of pull, this stock offers the eye relief of the newer M16A2 type stock. The stock's "hook" gives added stability to sandbag rest when shooting



with left hand across the body and into the hook. Molded of tough black fiberglass polymer - it easily replaces standard stocks. Uses G.I. issue standard buttplate but offers almost double the storage space.

Complete Buttstock Assembly with this "Hook Style" Buttstock... \$89.95 (AR STK ASSY CHO) Includes the stock, a trapdoor buttplate assembly, buffer, buffer tube, buffer spring, spacer and screw.

INDIVIDUAL A2 BUTTSTOCK AND TELESTOCK PARTS...

- A2 Trapdoor Buttstock** (9349119) **\$34.95**
- Trapdoor Buttplate Assembly A2** . (9381380) **\$19.95**
- Buffer - Standard** (8448615) **\$14.95**
- Buffer - Telestock** (1005-914-4578) **\$15.95**
- Buffer - Telestock** - heavy weight for the M16M4 machine gun) (8448730-M) **\$24.95**
- Receiver Extension - Std. A2** (8448581) **\$19.95**
- Car. Receiver Extension** (1005-914-2929-P) **\$24.95** (for the older style 4 position telestocks)
- A2 Buffer Screw** (9349128) **\$2.95**
- Buffer Spring (Standard)** (8448629) **\$4.95**
- Buffer Spring (Telestock)** (1005-914-4564) **\$4.95**
- Stock Spacer & Screw** (A2 STK SPAC/SCRW) **\$5.95**
- A1 Buttcap Screw** (8448627) **\$2.95**
- Telestock Locking Nut** (5310-917-1153) **\$6.95**
- Telestock Receiver Plate** (1005-914-2942) **\$6.95**
- Telestock Slide Locking Pin** .. (1005-914-3229) **\$5.95**
- Telestock Lock Pin Spring** (1005-916-9178) **\$.95**
- Telestock Latch** (1005-087-8987P) **\$6.95**
- Telestock Lock Pin Nut** (5310-917-1215) **\$3.95**
- Telestock Lock Pin Roll Pin** (MS16562-106) **\$.40**

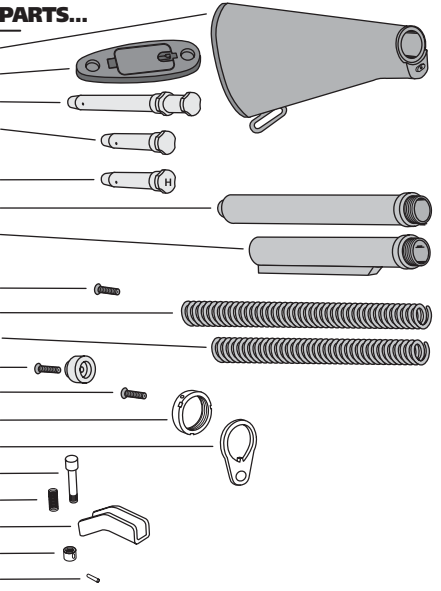

PISTOL GRIPS & BUTTSTOCKS...

See other Bushmaster Modular Accessories System components in the B.M.A.S. Section of this catalog.



Bushmaster Modular Accessories System Stock...

\$68.75 (Part # YHM-9569 Note: no receiver extension tube with this part #. Use your existing tube.)

A new lightweight buttstock design that features a strong shoulder piece affixed to a tubular "body". Slips over your existing receiver extension tube and locks in place with the standard buttplate screw. It is drilled and tapped in 7 locations for easy installation of a sling swivel stud such as the BMAS Swiveling Sling Stud (#YHM-9469). The tubular body of the stock is rubber covered for non-slip shooting comfort.

B.M.A.S. Stock with Receiver Extension Tube & Screw...
\$90.75 (Part# YHM-9569K)

Mini 14 / Mini 30 Replacement Stocks...



< Conventional Style...
\$64.95 (07-01-40)

Pistol Grip Style... \$69.95 (07-01-12)

thick non-slip rubber recoil pads, which increase the length of pull and improve shooting comfort. Both stocks include two 1" sling swivel loops, and both are simple drop-in installations. They are lifetime warranted by Choate.

The Conventional Style Stock is more streamlined and less bulky than the original wood piece.

The Full Length Pistol Grip Style reduces weight by skeletonizing the buttstock to a 3/8" thick "webbing" which in no way decreases strength or rigidity. The pistol grip allows you to hold the rifle in a more ergonomically comfortable position. This stock includes an off-hand notch feature in the buttstock, similar to the Russian RPK and HK21 Squad Auto - which allows you to hold the stock with your "off" hand when shooting with a bipod in the prone position.

Note: These stocks are made for 181 and newer series rifles only.

M1 Pistol Grip Stock... \$69.95 (08-01-02) A lightweight "skeleton" style stock complete with a 1" rubber recoil pad and 1" sling swivel, molded of black 20% glass filled polymer. This durable "drop-in" fit stock is many times stronger than wood. Manufactured in USA by Choate, and carries their lifetime warrantee.

Note: Fits military rifles only.



Note: Due to Pistol Grip design, this stock may not be legal for sale in California.

Ruger 10-22 Pistol Grip Stock...

\$69.95 (07-01-02)

Note: With Pistol Grip, this stock may not be legal for sale in California.



Molded of black 20% glass filled polymer, this durable, lightweight stock includes a comfortable 1" thick rubber recoil pad, two 1" sling swivels, and the ventilated handguard shown. Manufactured in USA by Choate - carries their lifetime warranty.

Ruger 10-22 and Mini 14 Buttpad...

\$21.95 (07-10-04)

This rubberized plastic butt-pad adds 1 inch to the overall stock length, improves trigger pull, and sticks to the shoulder to help get you on target fast. Also fits the Ruger 44 Magnum Carbine and the Ruger #3 Single Shot rifles.

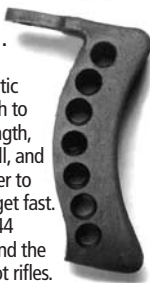

M1 Recoil Pad...

\$14.95 (CA501)

A sturdy, molded black rubber pad that helps take out recoil sting. Uses your existing single buttplate screw, but the pad should also be glued in place to prevent its rotation.



AK47 Adjustable Length Stock Extension...

\$29.95

(EL-AK-2) Adds 1 3/4"; 2 1/4" or 2 3/4" length to your AK buttstock for proper trigger pull. Made of high impact, glass-filled, black nylon. Includes a set of replacement screws for easy installation.



PISTOL GRIPS & BUTTSTOCKS...

SKS Dragunov Stock - Black...

\$89.95
(18-03-02)



Tough fiberglass-filled polymer composite stocks that install easily with common tools, these fine Choate stocks feature a matte textured finish on a "skeleton" design

for light weight. A Russian style steel sling mount pin is molded into the buttstock and a 1" thick deluxe rubber recoil pad is included for shooting comfort. Both models include handguards with cooling vents. The SKS model includes two 1/2" spacers for trigger pull length adjustment from 13" to 14" (See optional AK stock spacers below).

"Dragunov" Style Stocks for SKS or AK47 / MAK-90
AK47 / MAK-90 Dragunov Stock - Black
For rifles with milled receiver... \$54.95 (18-03-06)
For rifles with stamped receiver... \$54.95 (18-03-08)

These stocks may not be legal for sale in California. Consult with your Legislative Representative.

Optional Add-Ons for Choate Dragunov Stocks above...

Cheekrest - mounts either left or right side - Black... \$11.95 (18-04-02)

Buttstock Spacers for AK stocks... To achieve a comfortable custom fit and proper trigger pull Black rubber - 1/4" thick (18-05-03); 1/2" thick (18-05-05) or 3/4" thick (18-05-07) ... **\$3.50 ea.**

SKS Replacement Stock
\$59.95 (18-01-02)



A quality SKS replacement stock molded of durable black DuPont Rynite SST-35. Carries a Choate lifetime warrantee and features drop-in fit; a textured matte finish; and 13 5/8" trigger pull length (much longer than the original stock). Includes rubber recoil pad, grip cap, 1" sling swivel.

SKS Stock Butt Pad... \$14.95 (SKS01) Lengthens the standard wood stock by 1". Cut-away center allows access to the cleaning kit. Molded of heavy black rubber to increase comfort and maintain stock contour.

Bullpup Stock & Accessory Set for Ruger 10-22 / Mini 14 / Mini 30 / Marlin Camp Carbine... \$99.95 ea.

Upgrade the looks of your 10-22 (or other rifles listed) with this easily installed bullpup style stock. A scope mount and web sling are included in this package. All parts are molded of heavy black plastic.

Please specify your rifle:

- **Ruger 10-22...**
(Part # MWG-03)
- **Mini 14 / Mini 30...**
(Part # MWG-100)
- **Marlin 9mm Camp Carbine...**
(Part # MWG-200)



Note: This Stock Set is not legal for Sale in California

CM-2037 37mm Flare Launcher... For Standard Barrel Rifle... (701-20LSK) \$199.95 / For Heavy Barrel Rifle...

(701-19LSK) \$199.95 The ultimate signaling device for hunters, campers, boaters, etc. - it mounts under your AR15 or M16 rifle. Works on a sliding rail system with positive barrel lock. Easy to install, with all mounting hardware included (hardware available for standard or heavy barrels - please specify). Specifications: weight 4 lbs. 6 oz. (unloaded); steel components - black military finish; length 20 1/2" open - 15 1/2" closed; max. width 2 3/8"; smooth bore - includes cleaning brush. **WARNING: the CM-2037 Flare Launcher is NOT rated for Police Gas Canisters - Danger of Explosion!**

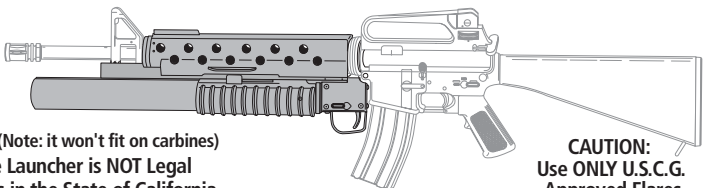
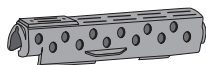

M203 Handguard
Included with this launcher (Note: it won't fit on carbines)
NOTE: The CM-2037 Flare Launcher is NOT Legal for use on Post-Ban Rifles in the State of California.

CAUTION:
Use **ONLY U.S.C.G.**
Approved Flares.

HANDGUARDS & ACCESSORIES... Bushmaster Varminter Tubular Vented Forend...\$89.95 (VAR-01K)

We use this vented, free-floating, three piece handguard on our popular Varminter Rifle, and it is now available to improve accuracy on your rifle. A finely machined barrel nut and its locking ring replace your existing barrel nut (front sight, gas tube and barrel nut removal required). The tubular aluminum free-floater screws on, and when correct "timing" of the 12 cooling vents is achieved, the locking ring holds it all in position. The center portion of the tube is knurled for a non-slip grip, and a standard stud is included for bipod or sling mounting. All three parts are machined of high quality aircraft aluminum, and black anodize finished to match your rifle.



Bushmaster V Match "Free-Floater" Tubular Aluminum Forends... \$59.95 each V Match Forends screw directly onto your upper receiver (replacing standard handguards, barrel nut and handguard cap). The hard anodized finished aluminum assembly fits over standard and match profile barrels - allowing your barrel to "free float" for optimum accuracy. **Note: Installation requires removal of the front sight base. (Will not fit Dissipator barrels.)**



For Rifles... (Part # SGW-02)
For Carbines... (# SGW-01)

Bushmaster M4 Type Handguards... \$39.95 (1005-914-4573) Similar to standard "shorty" handguards (and will replace them on any carbine), but the M4 type are fatter and more oval (taller) in cross-section, and have better barrel cooling capability. Molded of black thermoplastic composite material, they include heavy, black finished aluminum, internal heat shields.



A2 Standard Rifle Length Handguards...

\$19.95/pair (9349059) Compression molded of black composite polymer material to mil. spec. (not injection molded - these will not melt during full auto fire). Matte, non-reflective black finish, designed to fit rifles with either the triangular or round handguard cap. These handguard sets include internal aluminum heat shields that will help protect hands from barrel heat buildup under rapid fire. Carbine length handguards also available - see below.



< A2 Std. Carbine Handguards...
\$19.95/pair
(1005-914-4572)

See the Competition Parts section for DCM Competition "Free-Floater" Forends and "Free-Floater" Tube / Barrel Nut Combination.

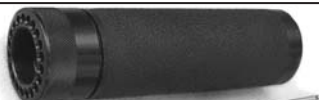

Hogue Free-Floater Carbine and Rifle Forends...

Hogue Carbine Forend & Gas Tube...

A unique aluminum free-floating forend with a central rubberized band for comfort and insulation against heat and vibration. Like our V Match tubes, Hogue forends require removal of the front sight and barrel nut. However, the Hogue two-piece forend **will** fit our Dissipator models. A companion pistol grip is also available (we use them on our Varminter).

Sold as a set with the Hogue Rubber Pistol Grip (shown right), or individually:

- Rifle Forend only \$74.95 (15002)
- 2 Piece Set / Rifle \$99.95 (15003)
- Carbine Forend only \$74.95 (15004)
- (Includes specially bent Gas Tube)
- 2 Piece Set / Carbine \$99.95 (15013)
- Pistol Grip only \$29.95 (15000)

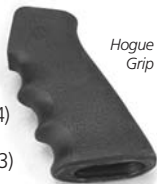

Hogue Grip

Now available... New, Carbine Length M203

Handguard... \$47.95 (12990563) This new shorter length M203 handguard is designed for carbine and M4 applications with the M203 Grenade Launcher. Gov't. issue, black nylon with aluminum heat



Rifle Length M203 Handguard \$29.95 (8448377)

New, original Gov't. issue black nylon handguard with inner aluminum heat shield designed for use with the M203 Grenade Launcher.



AR15/M16 Handguard Removal Tool... \$19.95

(Part # HGD-Tool) This handy tool provides the leverage needed to compress the weld spring inside the delta ring, and eliminates the need for a second person to help remove AR15/M16 handguards. We use this tool frequently at the Bushmaster plant. It is made from strong, powder coated, 1/4" round steel stock with protective vinyl coatings in all critical contact areas. Works equally well on both straight and tapered delta rings.



HANDGUARDS & ACCESSORIES...

Bushmaster Modular Accessories System (B.M.A.S.) Four-Rail Free Floater Forearms... Four solid Picatinny rails machined into these free floater forends offer your AR type rifle or carbine unlimited mounting options for sights, scopes, grips, lights, lasers, etc. Venting slots all around aid in barrel cooling, and rail front edges are drilled and machined to accept the B.M.A.S. Swivel Sling Stud (Note: That stud would not function as a bipod mounting point). These forends are machined from aircraft quality aluminum and hardcoat anodized to mil. specs. The rifle model fits 20" and longer barrels; the carbine version is designed for 16" barrels. Assemblies include forearm, barrel nut and jam nut. **Note: Barrel/front sight disassembly is required for installation.**

B.M.A.S. 4 Rail Forearm... For Rifle...\$199.95 (YHM-9480) / For Carbine... \$139.95 (YHM-9479)

Bushmaster (B.M.A.S.) 4 Rail Split Handguards...

\$179.00 (YHM-9670) This beautifully machined set of aircraft quality aluminum handguards will snap right in place of your standard carbine handguards, and offers four full length Picatinny configuration rails to allow mounting any flashlight/laser sight accessories you choose. The top handguard can be used in conjunction with an M203

Grenade Launcher. Finished in mil. spec. matte black anodize.



First Samco M-33 Handguard Set... \$89.99

(FBS-M33) The First Samco Two Rail Handguard set for carbines features integral Picatinny rails under removable covers. You can install this handguard set so as to position the rails vertically (12 & 6 o'clock) or horizontally (9 & 3). They're molded of high density black polymer, with stainless steel heat shields and comfortable rubber rail covers. The M-33 set is available for carbines only.

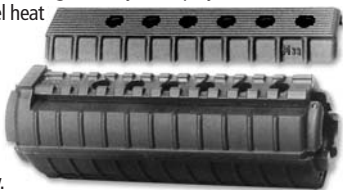

First Samco M44 Four Rail Handguard Set... For Carbine \$109.99

(Part#: FBS-M44S) / **For Rifle \$109.99** (Part#: FBS-M44L) First Samco's latest handguard set features 4 Picatinny rails hidden under removable rubber covers. The rails - positioned at 12-3-6-9 o'clock offer unlimited accessory attachment. The rubber covers add excellent grip comfort and protect the rails when not in use. Internal metal heat shields dissipate rapid fire heat. A handguard installation tool (see our HGD-Tool) is recommended for installation. **Photo shows Carbine set mounted with left side and bottom rubber covers removed.**

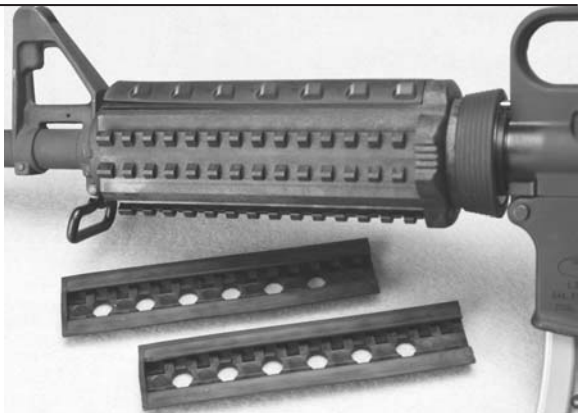

Sure-Grip Panels for Multi-Rail Forends...

These black rubber grip panels for Picatinny rail forends - with the Bushmaster logo molded into them - snap tightly onto the rails for protection and comfort. Two lengths available...

A. Sure-Grip Full Length Rail Cover... \$9.95 ea. (SCH-6L) 5 3/4" long for full length coverage on carbine forends. Covers fifteen rail slots. Black rubber with 3 molded Bushmaster logos.

B. Sure-Grip 1/3rd Length... \$3.00 ea. (SCH-6) 1 3/4" black rubber grip panel (covers five rail slots) for Picatinny rail forends with BFI logo.



HANDGUARDS & ACCESSORIES...

Bushmaster now offers 4 Models of the ARMS S.I.R. SYSTEM...

The ARMS S.I.R. (Selective Integrated Rail) System is a high quality technical forend for the AR15 Type Carbine that combines barrel free-floating, light weight, and a multitude of accessory attachment rails. Most models are intended to fit the A3 type flat-top Upper Receiver with the exception being this new Model 51C designed for the A1/A2 Solid Carry Handle Carbines (shown below). The new #51C Slimline model is approximately 1/4" narrower than the #45C or M models for a more comfortable grip. The S.I.R. Model 51C clamps solidly onto the fixed carry handle and the barrel nut to

provide an extended bi-level rail platform for scope and red-dot or holographic sights. Side and bottom rail segments provide mounting points for lasers, flashlights and forward pistol grips, and a side sling mount is included.

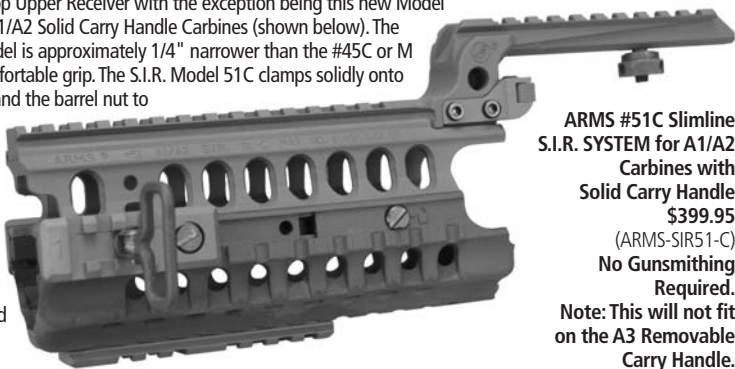

**ARMS #51C Slimline
S.I.R. SYSTEM for A1/A2
Carbines with
Solid Carry Handle**
\$399.95

(ARMS-SIR51-C)

**No Gunsmithing
Required.**

**Note: This will not fit
on the A3 Removable
Carry Handle.**

This new ARMS S.I.R. SYSTEM Model #50C - for the A3 flat-top Carbines... features the Slimline profile for

comfortable handling, and a Bi-Level rail system designed to accommodate optics and lasers. This model will co-witness with EOtech Sights.

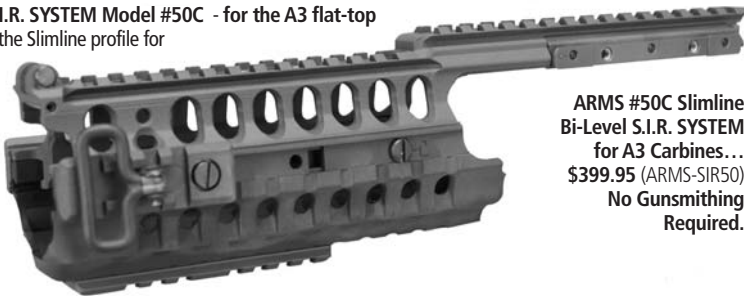

**ARMS #50C Slimline
Bi-Level S.I.R. SYSTEM
for A3 Carbines...**

\$399.95 (ARMS-SIR50)

**No Gunsmithing
Required.**

**ARMS S.I.R.
SYSTEM #45C
for flat-top A3
Type Carbines...**

**\$429.95
(ARMS-SIR45-C)
No Gunsmithing
Required.**



ARMS S.I.R. SYSTEM #45C

One of the original S.I.R. System models, the #45C fits A3 flat-top carbines with a "no-gunsmithing" installation which does not require removal of the Delta Ring for mounting.

**ARMS S.I.R.
SYSTEM #45M
for flat-top
A3 Type
Carbines...**

**\$429.95
(ARMS-SIR45-M)
Gunsmithing
Required / Delta
Ring removal.**



**ARMS S.I.R. System #45M
(Military) Model**

Clamps solidly onto A3 flat-top carbines with an additional lower support ring requiring removal of the Delta Ring for mounting.

NOTE: The ARMS #40 Flip-Up Rear Sight (see Sights/Scopes Section - Part # ARMS 40) is, by design, the only rear iron sight that will work with the ARMS S.I.R. System. It fits on the rail behind any of the S.I.R. models.

SLINGS & BIPODS...

Eagle Tactical Sling for AR15 / M16 Rifles... \$26.95 (TAS-1)

Quality tactical slings constructed of black 1" webbing. The rifle can be carried vertical position, then with an easy, one thumb release, it can be brought up to your shoulder. Features include a quick disconnect buckle, anti-noise padding at each end, and easy removal from the weapon.

Eagle Tactical Sling for CAR-15 & M4 Carbines... \$23.95 (TAS-3)

JFS Patrol Carry Sling... \$22.95
For Rifle or Carbine

Permits waist level carry and instant target acquisition with aimed fire from the shoulder. No modifications are required for use on either A2 Standard Buttstock or Telesstock. **Specify...**

For A2 Standard Stock... \$23.95 (STD - BP42-BK)

For Tele-stock Carbine... \$23.95 (CAR - BP52-BK)

High/Low Tactical Sling...

This sling brings the high carry - low carry advantages of the HK system to the AR15/M16.

A quick pull tab allows the transition from high to low carry. Installation is quick and easy. Sling ends attach to the weapon with no strap threading required.

For Fixed A2 Stock Rifle... \$26.95 (BP-43-BK) / For Tele-Stock Carbine... \$27.95 (BP-53-BK)

Gov't. Issue Sling... \$4.95 (12624561) Shown below, a 1.25" black nylon web sling (54" long) with two black buckles.



Quake Industries "Claw" Non-Slip Sling... \$36.95 (51000-0) A new, high quality 1" black webbing sling (shown below left) with a flexible, molded rubber shoulder pad that offers both silence and comfort - it won't slip or roll off your shoulder.



Turner Saddlery AWS Competition Sling... \$69.95 (TS-NMSRS) An extremely durable sling designed for DCM High Power Competition with the AR15/M16 rifle - approved for use by CMP and NRA. Made of a new All Weather Synthetic (AWS) material which requires no break-in, and will not stretch. These are custom stamped with a Bushmaster logo. Black (54-56") with steel hooks.



Padded Sling... For AR15/M16, or a variety of other rifles. Black webbing with a comfortable shoulder pad, and two black metal buckles. Specify 1" or 1.25" width:

1.25" wide Padded Sling...

\$12.95 (AS-60)

1" wide Padded

Sling...

\$12.95 (AS-60-1)



SLINGS & BIPODS...

Sling Mount Loops... For vertical carry mounting

of a variety of slings, the front loop mounts onto the sight assembly. For application on the buttstock, attach the loop onto the stock's rear sling loop. Phosphate finished - heavy spring steel wire.

Front & Rear Set - Two Loops...

\$7.95 (2698877K)

Or, Sold Individually...

\$4.95 each (2698877)



New BMAS Tactical Sling Adapter... \$9.95 (Part# 1005-914-2942-T)

This newly designed Bushmaster Modular Accessory System Tactical Sling Adapter is made for attaching various types of tactical slings. It allows mounting either web type slings or those that have "lobster claw" type clips. This phosphate finished steel adapter plate replaces the receiver end plate of your telescopic, and allows ambidextrous sling mounting on either the primary, or offside shoulder position for a comfortable "tactical" carry of the weapon. Removal of the stock and receiver extension is necessary for adapter installation. See other fine Bushmaster Modular Accessory System items in the B.M.A.S. Section of this catalog.



Harris Ultralight Bipods... Versatile, sturdy, light, and fast - Harris Bipods are real quality. Folding legs have completely adjustable spring-return extensions. The sling swivel attaches to the clamp. Quality manufactured with heat treated steel and hard alloys - all black anodized finish. These bipods swivel 45° for instant leveling on uneven ground and the hinged base has a tension adjustment and buffer springs to eliminate looseness. No gunsmithing is required - see mounting adaptors listed below. Extended Leg Length = 13" / Retracted Leg Length = 9"

Harris Model L for XM15 / AR15 / M16 and others... \$89.95 (HE-002)

Harris Bipod Adaptors - required for mounting on various rifles...

AR15 Adapter - Handguard mount type... \$19.95 (HE-001)

Mini 14 Adapter - Fits only Mini 14... \$19.95 (HE-004)

Universal Adapter - Barrel clamp-on style for most rifles \$19.95 (HE-006)



A2 Buttstock Sling Stud... \$13.95

(KNS-5) This phosphate finished steel stud replaces the old rear sling loop on standard A2 solid buttstocks. Unscrew the lower screw in the buttplate, then slip this in the loop cavity and replace the screw. Accepts any standard Quick Detach type sling swivel (as shown at right).



Quick Detach Sling Swivels... \$11.95 / pair

(KNS-4) These 1 1/4" Loop Quick Detach Sling Swivels (sold by the pair) are heavy steel with a phosphate finish to eliminate reflection. A screw locking knob ensures that the sling can't work loose from the rifle. Useful on all firearms that have standard sling swivel studs installed.



First Samco Equipment Mount... \$29.99

(FBS-BP1) The First Samco Equipment Mount has a standard dimension stud for mounting a sling or a bipod. Molded of high density black polymer, it slides onto any Picatinny or Weaver type rail, and locks on with a spring loaded push button mechanism.



Bushmaster Sling/Bipod Stud... \$5.00

(B-0807) As used on our Varminter, these universal bipod mounting studs will also mount any standard Q.D. type sling swivel. 3/8" shaft is threaded 10/32 - use a #21 drill bit before tapping.



See the Bushmaster Modular Accessory System Section (B.M.A.S.) of this catalog for additional Bipod Studs and Mounting Adapters.

Side-Sling Adapters... These adapters allow side mounting of slings to the barrel for easier ready position carry. The Aluminum version (left) fits standard diameter barrels (.625"), and will not fit a heavy profile barrel. The Steel version is adaptable to both standard and heavy barrels

(.75" diam.) by flipping the double concave lock plate when installing. This is the same mount as used in the original M203 grenade launcher kit.

< Aluminum Side-Sling Adapter... \$14.95 (NES-09K)

> Steel Side-Sling Adapter... \$32.95 (12598617K)



BUSHMASTER GUNSMITHING...

Our company policy is to offer gunsmithing assembly at no charge when parts are purchased from us (with the exception of sight bases). We will also offer our professional gunsmithing services to any customers who care to ship us their AR15 Type firearms or assemblies for repair or buildup - and we will work on brands other than Bushmaster. Gunsmithing time is charged at \$40.00 per hour, and we charge a flat \$15.00 fee for return shipping of your rifle, upper or parts. For an estimate on your gunsmithing needs, call 1-800-998-7928 during business hours or E-mail to: Techsupport@bushmaster.com

BUSHMASTER STANDARD ARMORER'S TOOL KIT...\$79.95 (A1 ARM KIT / A2 ARM KIT) A standard selection of indispensable tools for all AR15 assembly, disassembly and maintenance procedures (choose from A1 or A2 version - tools differ). Kit includes: Dual Slot Barrel Vise Jaw Blocks; Drift Punches; Barrel Wrench; Receiver Push Pin Tool; Technical Service Manual; Sight Tool; Cleaning Kit; Spring Package w/Standard Buffer Spring; and Assorted Pins; Screws; and Caps.

DELUXE ARMORER'S TOOL KIT... \$169.95 (A1 DARM KIT / A2 DARM KIT) A complete tool kit for all necessary repairs and installations (choose from A1 or A2 version - tools differ). Kit includes: Dual Slot Barrel Vise Jaw Blocks; Drift Punches; Armorer's Barrel Wrench; 200 Page Technical Manual; Sight Tool; Cleaning Kit; Heavy Duty Tele-Stock Wrench; Go/No-Go and Field Gauges Headspace; Firing Pin Protrusion Gauge; Receiver Push Pin Tool; Spring Package w/Standard Buffer Spring; and Assorted Pins; Screws; and Caps.

MASTER ARMORER'S TOOL KIT... \$299.95 (A MARM KIT) Total AR assembly and disassembly tools for the professional! Includes: Armorer's Action Block Kit; Lower Receiver Vise Block; Heavy Duty 223/308 Armorer's Wrench; Barrel Vise Jaw Blocks; Drift Punch Set; Rifle Cleaning Kit; .223 Headspace Gauges; Go/No-Go/Field; Firing Pin Protrusion Gauge; A1 and A2 Sight Tools; Heavy Duty TeleStock Wrench; Receiver Push Pin Tool; 200 page M16 A2 Marine Corp. Technical Manual; M16 A1 Technical Manual; Armorer's Video; Tetra Gun Care Kit; 2 complete spring packages (with carbine & rifle buffer springs), and assorted of pins, detents, screws and caps for fast and foolproof assemblies and installations. A great value - cost of components purchased separately would exceed \$325!

Mag-Brush... Keeps your magazine well and mags clean - which will help keep your firing chamber clean.
For Rifles... AR15, Mini 14 & 9mm UZI \$5.95 (MAG206)
Mag-Brush for .22; 10 mm; .38 Super... \$5.95 (MAG204)

Headspace Gauges... \$20.95 ea. High quality machined steel gauges for all .223 Caliber rifles and carbines - complete with instructions for use. Also available, a set for .308 Caliber rifles... (see part #s at right).



.223 Cal. Go-Gauge... \$20.95 (HGO223G)
 Used to determine adequate headspace. Chamber depth enough or oversized bolt.
.223 Cal. No-Go Gauge... \$20.95 (HGO223N)
 Used to determine excess headspace. Chamber depth too much or undersized bolt.
.223 Cal. Field Gauge... \$20.95 (HGO223F)
 Used to determine overly excessive headspace due to chamber and bolt wear.

.308 Cal. Go-Gauge... \$20.95 (HGO243G)
.308 Cal. No-Go Gauge... \$20.95 (HGO243N)
.308 Cal. Field Gauge... \$20.95 (HGO243F)

See Pages 40/41 for a complete Bushmaster XM15 Disassembly Diagram / Parts Reference

AR15/M16 Handguard Removal Tool... \$19.95



(Part # HGD-Tool) This handy tool provides the leverage needed to compress the weld spring inside the delta ring, and eliminates the need for a second person to help remove AR15/M16 handguards. We use this tool frequently at the Bushmaster plant. It is manufactured from strong, powder coated, 1/4" round steel stock with protective vinyl coatings in all critical contact areas. Works equally well on both straight and tapered delta rings.

Barrel Vise Jaw Blocks...

\$14.95 (AMER-001)
 A dual slot design for the installation of barrels, front sight removal rear sight work, cleaning, or any job that requires immobilization of the rifle - just insert into them into your vise. These heavy aluminum blocks are not limited to AR15/M16 service work - they make an excellent all-around gunsmithing tool, and they will not mar the finish of the rifle.

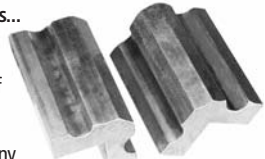

Receiver Push Pin Tool... \$6.95 (IMP-1) This handy tool will help push out tough Takedown and Pivot Pins in your lower receiver - and helps install the small pivot pin detent and spring. Conveniently fits into either the stowaway grip or the buttstock compartment.



U.S. Government Tech Manuals...

Complete maintenance, repair and troubleshooting info for either the A1 or A2 model (the A2 version is shown here).

A2... \$10.95 (TM9-1005-319-23P)

A1... \$10.95 (TM9-1005-249-24P)

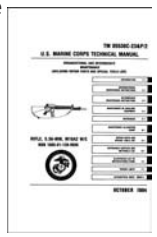

BUSHMASTER GUNSMITHING...

The Bushmaster DVD... \$23.95 (ADS-002)

Covers complete assembly/disassembly of the XM15/AR15/M16 rifle. This live, 60 minute, digitally photographed DVD will help you understand the complete system in extensive step by step detail. Our armorer describes the tools needed for every operation, shows the details of all subassemblies, and demonstrates functions, specifications, and uses of gauging equipment - all in sharp, digital close-ups. A brief history of the rifle's development is included, along with an overview of the wide variety of customizing parts and accessories available. Safety rules, and armorer's tips from our 40 years of knowledge and experience with the AR15 rifle system will walk you safely through any maintenance or repair work.

It's a "must-see" for any shooter, dealer or armorer.



Also available...

The Bushmaster Video... \$19.95 (ADS-001) All the live video instruction and information above, plus lots more in standard VHS format - 60 minutes.

Drift Punch Set... \$19.95 (STA PNCHSET) A set of four excellent Starret Punches - 1/16", 3/32", 1/8", 5/32" - all the necessary sizes for any work on the AR15/M16 rifle as well as other gunsmithing and mechanical projects.



Extra Heavy Duty Armorer's Wrench... \$29.95 (223-WRENCH) A sturdy wrench providing easier installation and removal of all AR15/M16 barrels up to 1" in diameter, with either encapsulated or peg style barrel nuts. Extra long handle has smooth contoured edges for comfortable use. Includes 1/2" square drive opening for torque wrench application; 5/8" and 3/4" slots fit receiver extensions and A1/A2 flash suppressor. Heavy steel construction with "hammered" black/grey finish - 12" overall length.



Extra Heavy Duty Tele-Stock Wrench... (above) \$19.95 (223-TELEWRENCH) Companion to the Armorer's Wrench above, and designed for easy installation/removal of all AR15/M16 telestocks. Heavy steel - 9" overall length - black/grey hammered finish.

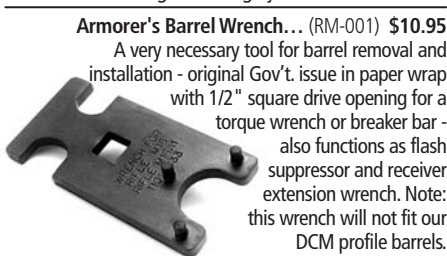

Armorer's Barrel Wrench... (RM-001) \$10.95

A very necessary tool for barrel removal and installation - original Gov't. issue in paper wrap with 1/2" square drive opening for a torque wrench or breaker bar - also functions as flash suppressor and receiver extension wrench. Note: this wrench will not fit our DCM profile barrels.



Bushmaster Manual... \$2.95 (BFIMANA20P)

56 Pages of information on XM15/AR15/M16 field stripping; cleaning, maintenance, with parts diagrams, safety tips and sight zeroing.



AR15/M16 Gas Tube Wrench... \$29.95 (MBC-01)

This tool eases the installation or removal of the rifle's gas tube. 5 1/4" long with black plastic handle. Also fits works on AR10 / SR25 rifles.



Bolt Carrier Carbon Scraper... \$29.95 (MBC-02)

A sturdy workbench tool for the AR15/M16 gunsmith. Makes quick work of cleaning out carbon buildup inside the bolt carrier. A few quick twists of the wrist can have your bolt carrier cleaned out and back to perfect function.



Field Bolt Carrier Carbon Scraper... \$19.95 (BC01)

This tool steel scraper quickly removes carbon buildup in all AR15/M16 bolt carriers. Just slide a section of cleaning rod into the hole in the end, insert in your carrier, and twist. And, it is small enough to fit into the buttstock storage compartment.



Sight Adjustment Tool... Front & rear sight adjustment tool in the original Government configuration. Machined steel - fits in the stow-grip or buttstock compartment.

For A1 Rifles... (Round Sight Post) \$7.95 (RAY-006)
For A2 Rifles... (Square Sight Post) \$7.95 (RAY-005)

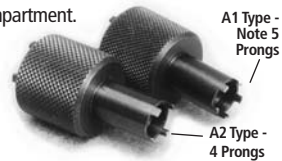

Tele-Stock Wrench for new style (ribbed) stocks... \$5.95 (223-telewrench2) This economical tool will keep the locking nuts tight on our newer type telestocks - both fixed and collapsible. Three lugs accurately engage the indents on the lock nut, and an additional hole fits the end of the receiver extension tube for assembly or disassembly. Stamped steel construction with vinyl coated handle for comfortable use.



BUSHMASTER GUNSMITHING...

Bushmaster Armorer's Action Clamp for all AR15/M16 type rifles... \$38.95 (OM-003) Bushmaster has built an improvement over our earlier Action Block. The new Armorer's Action Clamp works with all models of AR type rifles (even early A1's), including the popular A3 "flat-top" Upper Receiver - even when its Carry Handle is in place! Used in conjunction with an Armorer's Barrel Wrench (available from our Catalog or Website), it eliminates barrel vise jaw blocks for removing or replacing barrel assemblies, and is necessary when installing tubular aluminum V-Match handguards or competition "free-floating" tubes.

(Upper receiver is not included)

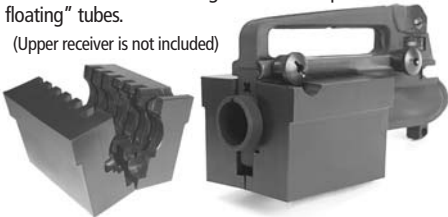

Firing Pin Protrusion Gauge...\$14.95 (MMT-0005) Check your firing pins for minimum (.028") and maximum (.036") protrusion. Excess pin protrusion can pierce the primer - causing the rifle to blow up. Insufficient protrusion results in rifle's failure to fire. Use this gauge to measure pin protrusion on the AR15 - XM15 - M16 or on any center fire rifle.



Otis Tactical Cleaning System... \$44.95 (750)

A 23 component cleaning system packed into a round black nylon soft-pak. It will clean barrels from .177 cal. to 10 gauge and includes 5 brass bore brushes; 3 forged brass tips; 3 memory-flex rods; a t-handle; a shotgun adapter; all caliber patches and patch savers; 1/2 oz. bottle of bore solvent; a NATO adaptor for military brushes; a bore reflector; and a cleaning manual.



Sight Adjustment Tool for Mini 14... Heavy blued steel. \$7.95 (ray-003)

Lower Receiver Vise Block... (OM-006) \$29.95 Clamp it in a vise, and it's magazine shape locks into the magazine well of any AR15-XM15-M16 lower receiver for assembly or maintenance work. Use in either normal or inverted positions. High density urethane will not distort or harm the receiver's finish.



(Vise, and Receiver shown are not included.)

Dewey Delrin Cleaning Rod Guides...

Maintain the original accuracy of your rifle by protecting the all important muzzle of the barrel - use these guides with all types of cleaning rods. Dewey Delrin Guides direct your cleaning rod straight into the barrel and prevent it from contacting the muzzle - some models have brass inserts for better rod wear protection. **Models for:**

AR15/M16 Postban... (.700" barrel - as are all current Bushmasters) \$8.95 (DEWEY-1100)

AR15/M16 PreBan... \$6.95 (DEWEY-300)

M14 & M1A... \$6.95 (DEWEY-500)

M1 Garand... \$6.95 (DEWEY-400)

Mini 14... \$6.95 (DEWEY-600)

Mini 30... \$6.95 Also fits Bullpup (DEWEY-700)

Ruger 10-22... \$6.95 (DEWEY-800)



Dewey AR15/M16 Breech Rod Guide...

\$19.95 (DEWEY-1000) For all M16's / AR 15's. Guides cleaning rod straight into barrel from breech end. O-Ring seal prevents oil and debris from coming back into the action. For barrels 24" and longer, we recommend using a 36" rod with this rod guide (see Dewey- 22CM-36 on the next page).



BUSHMASTER GUNSMITHING...

Dewey Coated Rods... These top quality rods feature sturdy one-piece construction; a large, unbreakable ball bearing handle and are 8-32 female threaded to accept standard brushes or other manufacturer's accessories. Each rod includes a universal style brass patch loop, and the rod's nylon coating protects delicate rifling and preserves your barrel's accuracy.



Dewey 22CF-24" - for barrels to 20" \$24.95 (Part # DEWEY-100)

Dewey 22CF-30" - for barrels to 24" \$24.95 (Part # DEWEY-200)

Dewey 22CM-36" - 8-32 male threaded with adapter - use with Breech Rod Guide in barrels 24" or longer. \$26.50 (Part # DEWEY-22CM-36)

Gun Cleaning Manual... \$5.95

(2000) All the techniques, tips, and correct information you'll need to keep your weapons clean and in top functioning condition. 52 pages of procedures with illustrations for rifles, shotguns, military cleaning, revolvers and autoloaders.



AR15 Multi-Tool... \$11.95 (Part # BT-MCT)

This handy tool packs several "AR" related functions into a compact package lighter than 2 rounds of ammo. The Multi-Tool is a (1) front sight adjustment tool; (2) a bolt face cleaning tool (removes residue and powder fouling); (3) a disassembly punch (large one for the take down pin, the smaller for lower receiver pins - neither will mar the finish of your rifle); (4) a tool useful as a Phillips screwdriver or a scraper; and (5) it includes a lanyard loop to tie it to your wear gear or tool bag. The high carbon stainless steel insert is heat treated to a Rockwell of 48-50 for long life.



Dewey Cleaning Rod Adaptor... \$2.95 (DEWEY-22-M-ADPT)

A machined brass adaptor threaded (female 8-36 / male 8-32) to accept the military type cleaning brushes - allowing them to be used with Dewey and other commercial cleaning rods.



Gov't. Issue M16 Cleaning Kit... \$9.95 (A CLEAN)

This complete kit includes a T-Handle; a 4 piece rod; swab holder; bore and chamber brushes. Will fit in the standard buttstock compartment of the AR15, XM15 or M16 rifle. All threading is the military 8-36.

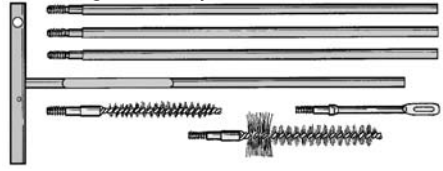

Cleaning Kit Case... \$7.95 ea. New Gov't. Issue nylon cases with snaps and velcro closures. Available in **Black** (PO303B), or **Olive Drab** (shown here) (PO303OD).

Cleaning Kit Combo... The Gov't. Cleaning Kit shown above packed in the nylon Cleaning Case Kit. >
Black... \$15.95 (cleankitB)
Olive Drab... \$15.95 (cleankitOD)



Buttstock Storage Cleaning Kit... \$43.95 (224-2)

A comprehensive, lifetime guaranteed, 15 component, 5.56mm cal. cleaning kit for the AR15/M16 packed in a wedge shaped Cordura pouch that is designed to fit in the rifle's buttstock compartment.



.223 Rem. / 5.56mm Caliber Chamber & Bore Brushes... High quality necessities for AR15/M16 maintenance and barrel cleaning...

Chamber Brush... \$1.50 (BR-001)

Bore Brush... \$1.50 (A190)



Threading is Military 8-36

TetraGun ProSmith™ Cleaning Rods...

These sturdy 3/16" diameter rods will fit the bore of everything from .22 rimfire and .223 on up to big bore magnums. Made from #416 heat-treated stainless steel, and Corvel M coated for maximum barrel protection, ProSmith™ rifle cleaning rods are equipped with a free-spinning Delrin handle with screw-on bushing and brass collar. These rifle rods may be used with most commonly available 8-32 thread brushes, jags and other cleaning tools. Order the Dewey adaptor above to use military (8-36) threaded brushes. Specify rod length...

TetraGun ProSmith™ Cleaning Rod 29" Length... \$23.95 (920-C)

TetraGun ProSmith™ Cleaning Rod 36" Length... \$24.95 (925-C)



GUNSMITHING LUBRICANTS & CLEANERS...

The Tetra Gun Cleaning Pack... \$19.99 (5337100802)

A superior firearms maintenance and preservation system based on a revolutionary breakthrough in synthetic polymer technology that will fight corrosion - reduce friction - reduce wear - improve performance - and make gun cleaning easier. **Tetra's Gun Cleaning Pack Contains...**

- **1 oz. Tetra Gun Lubricant:** A synthetic, polymer based lubricant and conditioner for action and all moving parts.
- **1 oz. Tetra Gun Grease:** Synthetic polymer based white grease for use on all metal to metal contact surfaces.
- **3.75 oz. Tetra Gun Spray:** Synthetic polymer based cleaner and light lubricant - removes dirt, combustion residue, old lubricants and solvents, and offers corrosion protection.
- **4 oz. Tetra Copper Solvent:** Concentrated copper, lead, powder, and plastic remover. Removes stubborn fouling from barrels and provides fast, effective cleaning without "barrel etching".



TETRA FIELD KIT... \$7.45 (TETRAFIELDKIT) All the necessities to keep your gun functioning on the range or in the field. Includes: 1 oz. tube Tetra Gun Grease and 1 oz. plastic bottle Tetra Gun Oil.

TETRA GUNSMITH'S KIT... \$29.95 (TETRAKIT) Professional quantities of high quality Tetra products: 2 - 1 oz. tubes of Tetra Gun Grease / 8 oz. Tetra Gun Oil / 8 oz. Tetra Gun Spray.

Tetra Gun Blue & Rust Remover... \$4.99 (5337100001) 3 fl. oz.

Removes old bluing and rust quickly and effectively without damage to base metal - necessary before rebelling or browning.

Tetra Gun Liquid Gun Blue... \$4.99 (5337100002) 3 fl. oz. A great product for touch-up or complete re-bluing of firearms. Fast-acting cold liquid yields a non-streaky, uniform blue-black finish to steel (**won't work on stainless steel, aluminum or nonferrous metals**).



Tetra Gun Copper Solvent... \$7.99 (5337100501)

Removes stubborn fouling without "barrel etching". All-in-one copper, lead, powder and plastic remover in concentrated liquid form. 4 fl. oz. bottle.

CLEANING PATCHES... \$4.99 (923)

Bag of 100... Sized for the AR15/M16 rifle bore, 100 soft white cotton flannel cleaning patches - a necessity for all firearms maintenance!

INDIVIDUAL TETRA PRODUCTS...

Tetra Gun Grease...

1 oz. Tube \$4.95 (5337100005)

Tetra Gun Oil...

1 oz. \$3.99 (5337100006)

4 oz. \$7.25 (5337100303)

8 oz. \$12.25 (5337100304)

Tetra Gun Spray Cleaner...

3.75 oz. \$6.99 (5337100201)

8 oz. \$10.99 (5337100202)



Firepower FP-10 "CLP" Type Lubricant... A Cleaner, Lubricant, and Preservative for Weapons & Weapons Systems, Firepower FP-10 is a semi-synthetic CLP specifically formulated for the serious Shooter, Soldier, Law Enforcement Officer, Sportsman and Professional Armorer. It's extraordinary abilities to clean, remove lead, lubricate, guard against extreme pressure and wear, and protect from corrosion - all in one product - make it the ultimate for the total care of all firearms, and other sporting goods.



< 1 oz. bottle... \$3.95 (FP-10-1)

4 oz. bottle... \$5.95 (FP-10-4)

16 oz. bottle... > \$13.95 (FP-10-16)



BIRCHWOOD CASEY

BIRCHWOOD CASEY HIGH QUALITY GUN REFINISHING PRODUCTS...

Birchwood Casey Super Black Touch-Up Pens... \$6.50 ea. Touch-up nicks, and scratches on black anodized aluminum, polished and matte finished alloy gun receivers, trigger guards, scopes or black painted surfaces - a fast drying, lead-free paint with superior adhesion and durability for gunsmithing uses. The felt tip chisel point touch-up pen holds 1/3 fl. oz.

For Gloss Black Finish... \$6.50 (Gloss - 15101) / or For Flat Black Finish... \$6.50 (15102)

Birchwood Casey Aluminum Black Metal Finish... (15125) \$7.95 3 fl. oz. This room temperature chemical is used by gunsmiths and the metal industry to blacken aluminum parts and to restore scratched or marred areas quickly. A fast acting liquid, it's easy to apply, and makes no dimensional changes to the part. Final color will vary from deep gray to black depending on the alloy of the aluminum part it is applied to.

SHOTGUN PARTS & ACCESSORIES...

Remington Pistol Grip Stock...



For 870,
1100 or 1187

12 Gauge
Only

Remington Pistol Grip Stock... \$69.95 (01-01-02)

These polycarbonate stocks are durable, heat resistant, require no modification of the gun and install with simple tools. Follow up shots are easier - recoil and muzzle climb are reduced. The non-slip buttplate offers storage space for cleaning gear, etc. Stock has two 1" sling swivels mounted, a third is included for top sling mounting. Carries Choate's unconditional warrantee.

For Remington 870, 1100 or 1187 only.

Tactical Pistol Grip Forends for Remington & Mossberg... \$32.95

Easier to point, aim and control in rapid fire situations, and slide operation is in a more natural angle for the hand. Lifetime guaranteed, this black fiber-reinforced polymer grip is waterproof and impervious to temperature extremes. Installs with supplied key - no special tools necessary.

Shotgun Barrel Heat Shields - \$19.95 ea. Made of heat resistant nylon to fit 12 gauge pump shotguns without vent rib or rifle sights. Installs easily without modification to the weapon.

Specify if for:

Mossberg (BW11A)

Remington (BW11C)

\$19.95 each



rough treatment test. Each comes with spring and installation instructions, and a sling swivel base clamp has been included with each extension for additional support. No alterations or special tools are needed. 7 Shot models are for 18" barrels and 8 Shot models are for 20" barrels. Remington models are available in a Parkerized finish.

7 & 8 Shot Magazine Extension Kits... \$41.95 ea. (Includes sling swivel base clamp kit described below.)

9 & 10 Shot Magazine Extension Kits... Increase capacity by 100% from 5 shots to 10 shots. These have the same features as our 7 and 8 shot extensions and a sling swivel base clamp is included with each extension to support the added length. The 9 shot extension is made for 22" barrels; the 10 shot is made for 26" barrel lengths. Blued steel finish.

9 & 10 Shot Magazine Extension Kits... \$47.95 ea. (Includes sling swivel base clamp kit described below.)

Part Numbers for Magazine Extensions...

Rem. 870/1100/1187 / Winchester 1200

7 SHOT... (01-04-02) (03-04-02)

8 SHOT... (01-04-03) (03-04-03)

9 SHOT... (01-04-04) (03-04-04)

10 SHOT... (01-04-05) (03-04-05)

Extra Magazine Extension Springs... \$4.95 ea.

If you leave your shotgun loaded, you will need fresh springs every 3 to 4 months as springs stored fully depressed lose their tension (this is why the military doesn't clip up their ammo before they go to war).

Please Specify...

7-8 Shot Magazine Extension Spring (60-09-11)

9-10 Shot Magazine Extension Spring (60-09-12)

Choate Mark 5 Adjustable Pistol Grip Stock...

Includes Two
1/2" Butt
pad
Spacers...
\$69.95



This black polycarbonate molded pistol grip stock is ideal for Law Enforcement Officers and hunters as well. Reduce your felt recoil and muzzle climb to make second shots faster and more accurate. Two 1/2" butt pad spacers and extra screws are included to allow length of pull adjustment from 13" to 14" (or special order additional spacers in 1/4", 1/2" and 3/4" thicknesses).

For Remington 870 (01-01-02-B)

For Remington 1100/1187 (01-01-34-B)

For Mossberg 500/600 (02-01-02-B)

For Mossberg 5500/9200 (02-01-07-B)

\$69.95

each

12 ga.

only



For Remington 870...
\$32.95 (01-02-04)

For Mossberg 500/600...
\$32.95 (02-02-04)

7 and 8 Shot Magazine Extensions...

Quality extensions made of solid blued steel to match your factory finish - they've passed every abuse and

Sling Swivel Base / Extension Clamp Kit...

These units add strength to the magazine extension - they're included in all of the extension kits sold above. Blued finish steel, a wood screw swivel is included for use on the buttstock. **Fit Remington and Winchester 12 Gauge Shotguns...**

For use with 1" slings... **\$9.95** (55-08-01)

For use with 1 1/4" slings... **\$9.95** (55-08-04)

NOTE: Not for use on Browning A5 or other reciprocating barrel shotguns.



SHOTGUN PARTS & ACCESSORIES...

Shotgun Shell Sling...

\$17.95 (SS-15L) Snap 15

rounds of additional

capacity onto your scattergun in seconds. Fastex spring hooks mount this 2" black nylon webbed sling to your existing standard sling swivels. Made with 1 1/2" wide elastic to hold the shells firmly in place. Lifetime Guaranteed.



Shotgun Bandoleer... \$26.95 (BDL-56) Carry plenty of extra shotshells with this quality bandoleer. It is designed to be worn over the shoulder and draped around the body, and holds 54 shells in heavy 1 1/2" wide elastic webbing on a 2 1/4" wide, black web belt.

Speed Loader Shot Shell Caddy...\$18.95 (60-09-22) This

black plastic, belt mounted shell carrier holds six extra 2 3/4" - 12 gauge shells to offer shotgun shooters easy accessibility and fast reloading.



Open Style Shotshell Carrier... Mounts to your shotgun stock with heavy black elastic straps and velcro. The shell carrier then velcros onto the straps so shells can be stored until needed in the field.

Open Style Shotshell Carrier...

\$19.95

(GSAC-12)

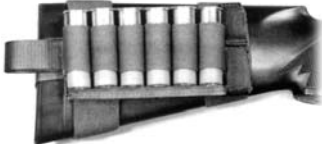

Closed Style Shotshell Carrier... Same tough black Cordura construction buttstock shell carrier as above model, but includes a velcro closure flap to protect shells against dirt, dust and rain.

Closed Style Shotshell Carrier...

\$23.95

(GSAC-12W)



Remington and Mossberg Shell Followers...

These high visibility followers protect

your magazine spring. If, under stressful firing conditions, you lose count and try to force in one too many shells when reloading, you can over compress the magazine spring. The coils then overlap and tangle. With this bright orange Shell Follower this can never happen - you'll see instantly whether the gun is loaded or not, and you'll avoid damaging the magazine spring.

For Remington 870/1100/1187 \$5.95 (01-05-02)

For Mossberg (12 Gauge only) \$5.95 (02-05-02)



Spare Shell Holder...

\$4.95 (60-09-50)

Carry two extra 12 gauge shells almost anywhere with this tough shell holder. Molded of black fiberglass filled plastic - mount it on a sling, wear it on your belt or screw it onto your boat's seat.

Remington 1100 Combat Bolt Handle...

A larger handle for the Remington 1100 bolt - allows you to reach over the gun and operate the bolt with your "off" hand, while keeping your other hand near the trigger. Fits Remington 1100 only.

\$8.95 (01-10-02)

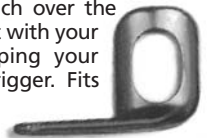

Remington Steel Spring Follower...

\$6.95 (01-05-03) Remington 870 and 1100 shotguns come with a light, hollow plastic, spring follower. When this follower breaks, your magazine spring will enter the receiver and hopelessly jam the action. To eliminate this problem, we offer this high quality steel replacement spring follower.

Fits Remington 870 and 1100 shotguns only.



BUSHMASTER SIGHT PARTS...



A2 Square Front Sight Post...
\$4.95 (9349056)
Standard M16A2 square design.



A1 Round Front Sight Post...
\$3.50 (8448572)
Original M16A1 round post.

(See our Competition Section for Competition Sight Posts)

A2 Square Front Sight Post for flat-top Colts... \$4.95 (9349056-M) Colt A3 Removable Carry Handles are taller than A1 & A2 handles and require this taller .040 Front Sight Post.



Front Sight Replacement/Repair Parts...

Front Sight Detent... \$1.25 (8448573)

Front Sight Detent Spring... \$.80 (8448574)

Front Sight Taper Pin... \$.95 (9349054BTP)

KNS Precision Front Sights... Quality replacement front sights for the AR15/M16 offering .010 diam. crosshair wires for a precise sight picture and hooding for reduced glare. The Tactical Model Dual Range sight (right) offers an adjustable elevation dot for close range targets below the long range crosshairs. It adjusts with an Allen wrench, and includes a spare vertical crosshair.

Standard Model...

\$35.95 (KNS1)

Wide Hood Model...

\$35.95 (KNS2)

Tactical Model...

\$49.95 (KNS3)



Trijicon Luminous Tritium Front Sight Post... \$51.00 (CP-25F)

This AR type front sight post (shown right) is functionally identical to the standard front sight post and fits either A1 or A2 models. Illumination from the Tritium insert is guaranteed for 10 years by Trijicon.



Trijicon Rear Sight Aperture... \$28.90 (CP-25R)
This quick, effective ghost ring style flip-up aperture for the AR type rifle houses two Tritium inserts in the larger aperture. Illumination is guaranteed for 10 years.

Trijicon Tritium Sight Set... \$71.40 (CP-25)

Both front and rear sights as shown above.

Williams Fire Sight for AR15/M16... \$39.95

(9349054F5B-WFS) This front sight design incorporates a light gathering element to improve the sight picture in low light situations (see the tubular piece that mounts along front edge of the AR sight base). The assembly is fully elevation adjustable, and all sight pieces are CNC machined of black finished aluminum. No drilling or tapping is required for installation on your front sight base.



See Pages 40/41 for a complete AR16 Type Rifle Schematic Parts Diagram



Complete XM15 E2 Rear Sight Assembly... \$49.95 (AR A2 RSA)

Latest M16A2 design with dual apertures and knob adjustment for elevation and windage. Dial in targets out to 800 meters - in 100 meter increments.

Also available, a complete 1/2 M.o.A. Rear Sight Assembly for the A3 Removable Carry Handle... \$49.95 (AR A3 RSA)

A2 Rear Sight Replacement/Repair Parts...

Rear Sight Elevation Index... \$6.95 (9349066)

Rear Sight Elevation Index Screw... \$.95 (9349065)

Rear Sight Elevation Knob... \$5.95 (9349067)

Rear Sight Elevation Spring... \$1.95 (9349070)

Rear Sight Elev. Spring Pin... \$.50 (MS16562-121)

Rear Sight Helical Spring... \$.50 (9349069) [3 used]

Rear Sight Ball Bearing... \$.50 (MS19060-4808) [3]

Rear Sight Windage Knob... \$5.95 (9349077)

Rear Sight Windage Screw... \$3.95 (9349076)

Rear Sight Windage Knob Pin... \$.50 (MS16562-98)

Rear Sight Flat Blade Spring... \$.50 (8448536)

Rear Sight Flip-up Aperture... \$7.95 (9349075)

Rear Sight Base... \$19.95 (9349074)

A1 Rear Sight Parts... Highest quality sight parts for those who prefer the simplicity of the original A1 design.

A1 Rear Sight Assembly... \$11.95 (A1 RSITE ASSY)

The original M16A1 configuration - adjustable with our A1 sight tool (see Gunsmithing) or with bullet tip.

A1 Windage Screw... \$2.95 (8448534)

A1 Windage Drum... \$2.95 (8448535)

Rear Sight Flat Blade Spring...

\$.50 (8448536)

A1 Windage

Drum Detent...

\$.50 (8448537)

A1 Windage Drum

Roll Pin...

\$.50 (MS16562-96)

A1 Drum Detent Spring...

\$.50 (8448538)

A1 Sight Aperture...

\$5.95 (8448539)

Adjustment Knob for A1 Rear Sight... \$9.95

(LMT-001K) This knob converts the A1 rear sight to the latest M16A1E1 configuration.

The phosphate finished steel knob is knurled for quick adjustment (no sight tool needed) and more precise half-click calibration. Knob only - use existing roll pin for changeover.



Complete A1 Rear Sight Assembly with our A1 Adjustment Knob... \$14.95 (A1-RSIGHT-KIT)

BUSHMASTER SIGHTS, SCOPES & MOUNTS...



The I.O.R. Bucuresti 4 x 24mm M2 .223 Tactical Model... \$349.00 (IOR-B-4x24-M2) I.O.R Bucuresti is one of Europe's oldest and largest optical factories. Versions of this scope have been in military service for over 30 years - all made to strictest military standards. It has a bullet drop compensated cam calibrated for the .223 cal. 62 grain projectile in ranges from 200 to 800 meters. For low light shooting, the seven stage battery powered reticle will assist target acquisition as it glows green. Batteries are the readily available 2032 3V Lithium type. The I.O.R. M2 .223 Tactical model features:

- a battery illuminated NATO Style Range-finding Reticle; an adjustable diopter; 30mm tube diameter; and a 29' field of view at 100 yards.

- a Carl Zeiss developed T3 lens coating system, with full multi-coating and anti-reflection treatment to eliminate glare and maximize light transmission

- "0" ring sealed 6061 T6 Mil.

Spec. alloy housings

- Superior optical glass made by Schott Glasswerk of Germany

- Nitrogen Filled / Waterproof / Fogproof / Shockproof



Representation of I.O.R.'s NATO Style Rangefinding Reticle

I.O.R. Bucuresti Quick Detach Rings... Mount these fine I.O.R. scopes with the matching I.O.R. 30mm heavy steel scope mount rings. Available in either medium or high versions, they feature sturdy quick-detach levers and four clamping screws on each ring assure a rigid mount with removability and a guaranteed return to zero. The High ring set (pictured here) is designed for the A3 type flat-top upper receivers.



- **I.O.R. Bucuresti Quick Detach Rings... Medium (1/2" rise)...** \$69.00 /pair (IOR-B-QD-Ring-Me)

- **I.O.R. Bucuresti Quick Detach Rings... High (3/4" rise)...** \$89.00 /pair (IOR-B-QD-Ring-Hi)

- **I.O.R. Bucuresti Ring Inserts...** (Not Pictured) Precision machined steel inserts for mounting 1" scopes in the 30mm ring sets shown. ...per set of 4... \$19.95 (IOR-B-1in-Insert)

The EOTech HOLOgraphic Diffraction Sight (HDS) is the first system to apply holographic technology to small arms. When used in Close Quarter Battle (CQB) environments, this revolutionary optic delivers amazing speed and accuracy gains, an uncompromised use of peripheral vision, and leaves no muzzle side operator signature.

When the situation is critical, fast, accurate target acquisition can make the difference. The HDS delivers speed gains for the initial weapon presentation, in multiple target situations, and in conditions where either the operator or the threat(s) are moving rapidly. Engaging around physical barriers or in awkward shooting positions are now made with ease while ensuring rapid reticle to target lock-on. The HDS locks onto the target as fast as your eyes do.

The HDS has been designed and tested to provide consistent, reliable performance even in the most hostile operational environments. It is waterproof, fogproof, shockproof, and temperature proof. The Heads Up Display is constructed with a 3 layer, shatterproof laminate glass that is 3/16" thick for added durability. Additional protection of the Heads Up Display is provided with a "roll bar" ruggedized hood. The HDS does not emit any muzzle side position revealing light signature... the projected reticle pattern is visible only to the operator.

EOTech 510 HDS Sight... \$338.95 (EOT-510) N Battery powered with 1 M.o.A. aiming dot.



Representation of EOTech Reticle

BUSHMASTER SIGHTS, SCOPES & MOUNTS...

EOTech's Model 552 Holographic Diffraction Sight (HDS) features the rugged quality of all their models, but incorporates the convenience of common AA battery power. In normal operation, there are 20 reticle brightness settings in either 4 or 8 hour auto-shutdown modes. With "heads-up display" technology adapted from F-14 Tomcat Fighters, the Holographic Diffraction Sight is the first electro-optic sighting system to apply holographic technology to small arms.

The Model 552 features a night vision mode capability which can only be used with night vision equipment such as ANSPV7 Goggles or ANSPV14 Night Vision Scope/Goggle. With this system, 1 M.o.A. groupings can be achieved out to 300 yards. Windage and Elevation can be adjusted in 1/4 M.o.A. increments.

EOTech uses state of the art digital electronics design, and is waterproof, fog proof and shockproof. Twenty brightness levels ensure proper brightness control in either low light or bright sunlight. A microprocessor provides automatic battery check indicator, up/down brightness scrolling and programmable auto shut down features. All electronics are encapsulated in shock absorbing resin compound, and the HDS has been extensively tested on recoil simulators. The sight's tubeless design provides an unobstructed field of view for two-eyes-open shooting. Simply look through the 1/4" thick shatterproof laminate window, place the reticle image on the target and shoot. 1 M.o.A. aiming dot reticle patterns are instantly visible in even the lowest light, instinctive to center regardless of the shooting angle or position, and remain in view between shots. Additionally, anti-glare coatings on the optical surface eliminate any muzzle side reflective signature, and a rugged "roll-bar" hood protects the display. The EOTech HDS will mount to any Picatinny configuration rail.

EOTech Model 552* HDS Sight (shown above)... \$429.95 (EOT-552) ...AA Battery Powered with Night Vision Mode (*must be used with night vision equipment to achieve full Night Vision Mode compatibility - but can be used as a normal holographic sight).

The Simmons AETEC 2.8-10x44mm Scope... \$149.95

(2101) The aspherical lens system was first used on expensive binoculars and cameras, and Simmons has adapted this technology to the rugged AETEC scope - allowing a wide field of view with a completely flat image and edges that are as bright as the center. The AETEC 2.8-10x44mm scope offers longer eye relief than conventional wide angle systems and features a fully multi-coated lens system and 1/4 min. adjustments. It is waterproof, fog proof and shockproof. (Does not include the rings or flat-top mount pictured here.)



Trijicon ACOG TA01NSN Special Forces Sight... \$956.25

(TA01NSN) The Trijicon ACOG TA01NSN fits the AR15/M16 "flat-top" rifles and includes the TA51 flat-top mount shown here. ACOG is an acronym for Advanced Combat Optical Gunsight - and this one is the choice of many Special Forces groups. It has been designed to withstand shock, vibration, temperature extremes, water, dust, sand and hard surface drops. Unique modifications to this model include an integral rear ghost ring aperture and a tritium glow-in-the-dark front sight for close combat back-up sighting. This model's TA51 mount also works with the Trijicon TA01 and is sold separately. See next page for more Trijicon products.



EOTech Model 552 HDS Sight... \$429.95 (EOT-552)



BUSHMASTER SIGHTS, SCOPES & MOUNTS...

The Trijicon Advanced Combat Optical Gun Sight...

Trijicon A.C.O.G. for AR15/M16... \$807.50 (TA01)

The finest optical design, 100% U.S. made components and Mil-C-14806A multi-layer coated glass elements make the ACOG the ultimate telescopic sight. Tritium elements cause the black daytime reticle in the ACOG 4x32 to glow red at night and in low light. A forged aircraft aluminum housing is precision machined and hard anodized to match the finish of the M16. To the ACOG's unique internal adjustment system (only the prism housing moves) makes this the most rugged scope available - it will withstand exposure to temperature extremes, salt spray, fog, fungus, humidity, sand, dust, shock, vibration and aerospace seals make the ACOG waterproof. A see-through channel in the integral base permits use of the iron sights while the scope is mounted. Attachment to the rifle's carry handle is with one or (optionally) two screws. Trijicon ACOGs are adaptable to H&K; Sig 550; Beretta AR 70/90 with various A.R.M.S. adaptors. Dovetail adaptors for popular hunting/target rifles are available.



Trijicon TA51 Mount for ACOG... \$61.20 (TA51) Knurled thumbnuts allow quick installation and removal on any mil. spec. flat-top model. The ACOG scope mounts into the center channel with two screws - use Loctite to keep it from "shooting loose".



Trijicon Reflex Gun Sight for AR15/M16 with 4 Minute of Angle Sight Dot...

Military evaluation trials have proved that "this sight is a winner" - a rugged system with no switches to turn off, or batteries to change. The fluorescent fiber optic system glows brightly during the day and varies in brightness automatically according to target area ambient light. The aiming dot is illuminated by light from the target area and from a tritium lamp, providing optimum target contrast at all times while eliminating the need for battery power. The reflex sight aids the human sense of balance while aiming with both eyes open. Hunters and competition shooters will also appreciate how quickly this sight puts you "on target". The AMBER aiming dot is far superior to traditional red dots because of the human eye's sensitivity to amber. The 4 MoA dot is small enough to avoid covering too much target at distances but large enough for close range, quick target acquisition.

- **4 M.o.A. Dot Reflex Sight** with Amber Dot Reticle and mount for flat-top type Receivers (shown left)... **\$402.90 (RX05-14)**
- **4 M.o.A. Dot Reflex Sight** with Amber Dot Reticle and mount for A2 Carry Handle Receivers... **\$424.15 (RX05-10)**



Additional Trijicon Reflex Sight Models...

- **6.5 M.o.A. Reflex Sight** with Amber Dot Reticle and AR15/M16 Carry Handle Mount... **\$475.00 (RX01-10)**
- **6.5 M.o.A. Reflex Sight** with Amber Dot Reticle and AR15/M16 Flattop Mount... **\$455.00 (RX01-14)**
- **4 M.o.A. Reflex Sight for M4A1...** Custom designed for the M4A1 and supplied to U.S. Special Forces with Amber Dot Reticle, flattop adaptor, polarizing filter, and dust cover... **\$469.00 (RX01NSN)**
- **4.3 M.o.A. Reflex II Sight** with Amber Dot Reticle and AR15/M16 Carry Handle Mount... **\$545.00 (RX07-10)**
- **4.3 M.o.A. Reflex II Sight** with Amber Dot Reticle and AR15/M16 Flattop Mount... **\$525.00 (RX07-14)**

Reflex Sight Accessories... These genuine Trijicon accessories will fit all Reflex models with sunshades (like the model shown above).

- **Polarizing Filter for Reflex...** **\$13.60 (RX20)**
- **Lens Dust Cover for Reflex...** **\$5.95 (RX21)**
- **Anti-Glare Filter for Reflex...** **\$51.00 (RX22)**

First Samco Tactical Light Mount... This simple mount will accept 1" or 15/16" diameter flashlights and hold them solidly with an internal rubberized pad-clamp. It slides onto the First Samco M33 Handguard rail - or any Picatinny type rail - and locks in place with a rugged push button mechanism. Molded of high density black polymer.



- **First Samco 15/16" Tactical Light Mount...** **\$29.99 (FBS-FAS-3)** For Streamlight Scorpion and other 15/16" diameter flashlights.
- **First Samco 1" Tactical Light Mount...** **\$29.99 (FBS-FAS-2)** For Surefire & other 1" diameter tactical flashlights.

Snap-on Forearm Light Mount \$29.95 (HPM3)

This is a heavy plastic base with molded detents that grip the vent holes in the standard type forearm (shown here installed, and separately). On this side is a Picatinny style base that will accept scope rings or other rail type mounts allowing you to clamp on a variety of flashlights.



A.R.M.S. SIGHTS, SCOPES & MOUNTS... See the **A.R.M.S. S.I.R. System** in our **Handguards Section**.

A.R.M.S. #2 Scope Mount for M16A1/A2... \$59.95 (5855-01-299-777) An excellent "handle mount" style scope platform for the AR15/M16 family of rifles. It features the Swan universal mounting platform which accepts most all current military and police sighting systems, including NATO Stanag and Weaver type rails, without the need for adaptors. Other features include:

- "See thru" channel - enables existing iron sight use
- Fast positioning with fixed toggle bolt
- Self-locking thumbnut - will not loosen
- Repeatable zero hold
- Same tough finish as on your rifle



A.R.M.S. #19 Weaver/Stanag Throw Lever Mount... \$140.00 (ARMS 19) Mount scopes, sights, etc. directly onto the A3 flat-top receiver with guaranteed repeat zero or, with an ARMS#2 carry handle mount, interfaces to M16A1/A2/M4.

< A.R.M.S. #5 MultiBase... \$59.95 (ARMS 5) A quick detach, multiple eye relief mount featuring a spring loaded clamping bar and Nato Stanag & Weaver rail fastening. Easily mounts to Picatinny/Weaver type rail or flat top receiver with locking, captivated thumbnuts.

A.R.M.S. #19A Throw Lever Channel Mount for ACOG Sights... \$150.00 (ARMS 19 A) The center "channel" mounts Trijicon ACOG Scopes to mil. spec. Picatinny/Weaver style rails with the convenience of A.R.M.S. repeat zero throw levers (positioned to the left side so as not to obstruct the rifle's ejection port). A mounting crossbar assures perfect repeat positioning.



A.R.M.S. #40 Low Profile Stand Alone Flip-Up Rear Sight... \$99.95 (ARMS 40) The A.R.M.S. Stand Alone Flip-Up Sight utilizes the same concept as the rear sight on the Swan Sleeve system (just below). This U.S. Patented sight locks down with a quick release lever when not in use (Shown in both deployed and lock-down positions). When the sight is deployed, its stainless steel, spring loaded mechanism will always keep it available - even when going through brush, or if the rifle is dropped. Its flip-up combines a 250-300 meter close combat aperture and a 500-600 meter aperture with a horizon line feature that helps lead distant targets. The automatic zero stainless steel retention plate and clamping bar/pin won't rust, and the entire sight is matte black finished - fits any mil. spec. flat-top Picatinny rail. The newest design of this sight includes a low-profile windage adjustment knob. **Note: By design, this sight is the only rear flip-up that fits with the A.R.M.S. S.I.R. System forends shown on Page 54. Also, due to the aperture height of this sight, you should order the .040 higher front sight post shown on Page 64 (9349056-M).**

A.R.M.S. Swan Sleeve... An Optical Platform with Integral Flip-Up Rear Sight for the M4A3 Carbine; M16A3; or any mil. spec flat-top model. The Swan Sleeve, patented by A.R.M.S., Inc., provides a platform for various scope/sight mounts via the A.R.M.S. standard mil. spec. dovetail type rail system. The spring loaded flip-up rear sight (shown in "up" position) aligns with the existing front sight (use .040 taller front sight post - see Pg. 57) ; always stays in battery and can't be knocked down by accident. This rear sight provides an A2 type windage adjustment with standard 250-300m range zero and a new 500m horizon line setting. Swan Sleeves, currently in service with U. S.

Armed Forces, are manufactured of strong, anodized aluminum alloy in three lengths with provisions to accept a wide variety of additional attachment rails, lasers or optics. **Specify:**

- **Super Extended Length (14" - includes "brush breaker")... \$180.00** (ARMS 38s-ex)
- **Extended Length (8.46")... \$165.00** (ARMS 38ex)
- **Standard Length...(shown) \$150.00** (ARMS 38std)

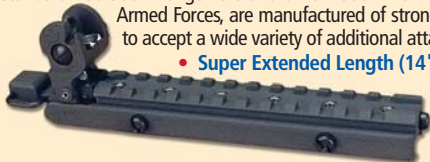

A.R.M.S. #22 Throw Lever Rings... \$89.95 per pair Patented 30mm steel rings secured with A.R.M.S. dovetail system to an extruded aluminum platform. Built in "No-Mar" Pads protect the rail, and spring loaded levers act as shock absorbers. These rings will not freeze or absorb mud or sand. They offer guaranteed repeat zero hold and are available in three heights: **\$89.95/per pair - Low - 1/4" rise** (ARMS 22L) **Medium - 1/2" rise** (ARMS 22M) / **High - 3/4" rise** (ARMS 22H)



A.R.M.S. #37 Ring Inserts... \$29.00 (ARMS 37)

Steel inserts that allow use of 1" diam. scopes within 30mm rings.



A.R.M.S. SIGHTS, SCOPES & MOUNTS... See the **A.R.M.S. S.I.R. System** in our Handguards Section.

A.R.M.S. #39A2 Bi-Level Rail... \$125.00 (ARMS 39) Mounts to M16A1 & A2 carry handle for multiple combinations of attachments, and provides rigid support of the dovetail platform that is extended over the handguards.

A "brush breaker" on the front will prevent branches from snagging and a "see-thru" channel in the #39A2 Upper Rail allows the use of existing iron sights.

Note: This mount will not fit on the A3 Removable Carry Handle.



BUSHMASTER SIGHTS, SCOPES & MOUNTS...

Bennie Cooley Co-Witnessing Adjustable Mount

for AR15/M16...
\$139.95 (EOT-12)

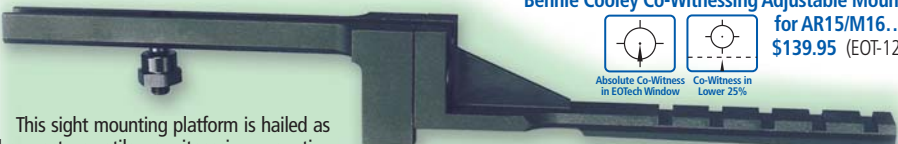

This sight mounting platform is hailed as the most versatile co-witnessing mounting system manufactured. It is vertically adjustable for easy alignment and custom fitting of any red dot optic (EOTech Hologight, Trijicon Reflex, Aimpoint Comp or others) in relation to the iron sights of the rifle or carbine. Height adjustments are made by loosening the 8/32 button head retaining screws with the supplied 3/32 Allen wrench.

Mark Brown Custom Flat-top Mount... \$195.95

(MBC-03) A quality mount for any V Match or flat-top model that incorporates a standard A2 rear sight (adjustable for windage and elevation). It is designed as a rail base for view-thru optics such as the EOTech Hologight and is machined from aluminum alloy with a black anodize finish. The A2 rear sight steel parts are manganese phosphate finished.

Note: The Trijicon Reflex sight is too tall to work with this mount.

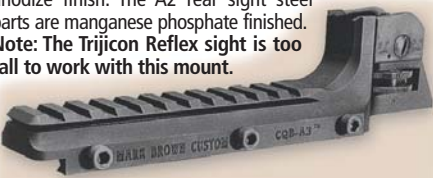

Kwik-Site See-Thru Scope Mount and Scope Ring Set... \$49.95 (KSN-M16)

For A1 or A2 rifles, this handle style mount features a wide see-thru channel for use of existing open sights - a pair of horizontally split 1" scope rings with easy-off knurled screws is included.

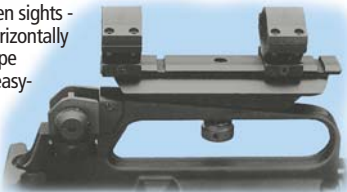

Aluminum Scope Ring Sets... \$14.95 per pair

Top quality, matte black finished ring sets to fit any Picatinny rail. U.S.A. made - heat treated aluminum with 8-32 socket head screws in 1" Low, Med. or High Profile horizontally split design. 30mm style is vertically split. Wrench included with each set. **Specify:**

- 1" Low** (W-20524) / **1" Medium** (W-20515)
- 1" High** (W-20525) / **30mm Medium** (W-20513)



Aluminum Scope Mount... \$19.95 (RAY-002)

A machined aluminum, anodized, "see-thru" Picatinny-Weaver rail mount which allows the use of existing iron sights. It attaches to the carry handle with a thumbnut.



M203 Grenade Launcher Quadrant Sights for A2 & A3 Type Rifles... \$76.95

These are Gov't. Issue Quadrant Sights for the M203 Grenade Launcher. Sights include a flip-out post & aperture system, combined with an elevating scale set in 25 meter increments from 50m to 400m. There are models for both the A2 Solid Carry Handle rifles and carbines, and the A3 Removable Carry Handle type (though they are not interchangeable). These sights could also be use with the CM-2037 37mm Flare Launcher shown on Page 51.

M203 Grenade Launcher Quadrant Sight ...

For A2 Solid Handle Rifles... \$76.95 (9346304)

For A3 Removable Handle... \$76.95 (12598114)



THE BUSHMASTER MODULAR ACCESSORY SYSTEM...

...is a complete collection of quality accessories specifically designed to enhance the performance and versatility of your Bushmaster (or other brand) AR15 type Rifle or Carbine. They're all manufactured from superior materials to the tightest tolerances and quality standards - and in most cases, they can be easily installed with simple hand tools. Get into the "System", and get the most from your Bushmaster... See them all on the next pages.

Bushmaster Modular Accessories System (B.M.A.S.) Front Flip Sight for V Match Rifles and Carbines... \$99.95 (YHM-9360K)

A high quality front sight that clamps around the V Match milled sight base/gas block - designed to be used with any open iron rear sight. This patent pending Front Flip Sight is machined from aircraft aluminum with an anodized finish, installs with an Allen wrench, locks up or down with a push button and is elevation adjustable. A standard front sight post is included, and the base is drilled and tapped for our B.M.A.S. sling swivel mount (see Part # YHM 9469).

< Sight Installed (folded down position)

Complete Sight >

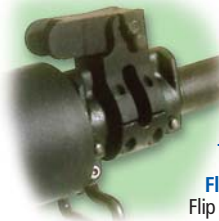

Bushmaster Modular Accessories System Detachable Front Flip Sight & Three-Rail Gas Block...

The B.M.A.S. Detachable Front Flip Sight (patent pending) is designed to clamp snugly on the gas block's top rail with a pair of socket head screws for repeat zero every time. Machined from aircraft aluminum billet, it locks up or flips down at the touch of a button. A standard A2 front sight post with spring and detent locking system offers elevation zeroing just as with the original M16A2 sight system.

The B.M.A.S. 3-Rail Gas Block can be ordered on new barrels as a factory installed option, or we can factory retrofit existing sight bases on .750" barrels. It's three rails are in standard Picatinny configuration to allow addition of flashlight or laser as side mounts. The B.M.A.S. Three Rail Block is precision milled from alloy steel; finished in black manganese phosphate; and drilled and tapped on the bottom for the addition of a sling swivel stud (Note: this stud is not intended for bipod mounting).

B.M.A.S. Detachable Front Flip Sight and Three Rail Gas Block are available separately, or as a SET:

- Detachable Front Flip-up Sight only...\$72.95 (YHM-9371K)
- 3-Rail Gas Block only...\$52.95 (YHM-9370)
- Detachable Front Flip-up Sight & Three-Rail Gas Block SET... \$119.95 (YHM-9370K)



B.M.A.S. Low Profile Clamp-on Front Sight... \$74.25 (YHM-9584K)

A low profile design front sight that folds flat at the touch of its side button to allow scope clearance for any large bell scope you might choose. Includes standard AR front sight post and detent system and is adjustable for elevation. The quality alloy steel parts are finished in phosphate black.



B.M.A.S. Fixed Clamp-on Front Sight... \$47.25 (YHM-9495K)

A standard height, fixed style front sight, this unit adds the convenience of a quick detach knurled thumbnut and clamping to zero upon reattachment and includes standard AR front sight post and detent system - adjustable for elevation.



B.M.A.S. Rear Flip-Up Sight... \$75.00 (YHM-9440)

An aircraft grade aluminum, flat-top mounted, flip-up auxiliary sight - for targets out to 300 meters - features dual apertures, 1/2 M.o.A. windage adjustment, black anodized finish. A side button lowers it to make room for your optics or scope on a flat-top rail. This design offers the convenience of a right hand adjustment knob and a full height sight aperture. Also, the height of this sight when folded - is 1/8" lower than similar designs.



B.M.A.S. AR Flat-Top Rear Sight... \$89.95

(YHM-643K) Fits standard flat-top AR receivers and offers the convenience of the familiar AR15 iron sights with the option of mounting optics further forward on the flat-top's rail. The sight's base is a heavy, black anodized billet aluminum block and sight components are A3 (1/2 Minute of Adjustment) with windage and elevation adjustment.



BUSHMASTER MODULAR ACCESSORIES...

Bushmaster A3 Type Removable Carry Handle with 1/2 M.o.A. Rear Sight... \$99.95 (9349063-9) Add versatility to your "flat-top". Our carry handle clamps solidly onto your V Match Upper in seconds with knurled thumbnuts, and includes an A2 dual aperture rear sight with 1/2 M.o.A. windage and elevation adjustment.



B.M.A.S. Rail Extension... \$34.95 (YHM-9474) This 5" rail extension attaches to any flat-top upper receiver to raise and mount forward any variety of optics. The Extension's height is the same (1/2") as our B.M.A.S. scope risers above. Shown at right on flat-top and separately, it also works well with our B.M.A.S. Triple Mount to offer extra mounting surface for laser light combinations, forward grips, and accessories. Precision machined of aircraft aluminum with a hard anodize finish.



B.M.A.S. "Wide-View" Scope Mount... \$24.95 (WSM-AR15K) This A2 handle type Scope Mount allows a wider field of see-thru view than other similar mounts, and is reversible for improved forward or rearward scope placement. It is machined of anodized aluminum to standard Picatinny rail dimensions for easy scope ring attachment - accepts Weaver type scope rings as well. Attaches with a steel "button-head" screw and includes a shortened 5/32 Allen wrench to fit inside the handle space.



B.M.A.S. Quick Detach Rail Extensions – Available in 4" - 7" - 11.25" Lengths... These Rail Extensions – precision machined to standard Picatinny rail dimensions – mount on all AR15/M16 flat-top Upper Receivers to elevate the scope/optic mounting surface approx. 1/2". The two longer lengths can join and solidify the Upper Receiver to any Four Rail Forend offering the extra mounting surface length necessary for very large/long scopes or "scout-style" mounting. All 3 Rails offers the convenience of quick detach/reattach with knurled thumbnuts. Anodized, machined aluminum with phosphated steel thumbscrews and clamping bars.

4" Q. D. Rail Extension... \$37.25 (YHM-9595)

7" Q. D. Rail Extension... \$59.25 (YHM-9592)

11.25" Q. D. Rail Extension... \$81.50 (YHM-9590)



7" B.M.A.S. Quick Detach Rail Extension



A.

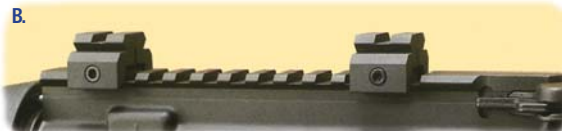

B.

B.M.A.S. Scope Risers... Available in Two Lengths These risers increase scope height on flat-top AR style firearms by 1/2 inch to achieve proper cheek weld on the stock. Two Risers are required - one for each scope ring. Machined from hard mil. spec. anodized aircraft quality aluminum, they fit all Picatinny/Weaver base dovetails. We use the A. size on our Varminter. **A. 1 1/4" Length...** \$14.95 ea. (YHM-226) / **B. 3/4" Length...** \$12.75 ea. (YHM-9490)

Bushmaster Modular Accessories System Four Rail Free Floater Forearms for Rifle

and Carbine... Four solid Picatinny rails machined into these free floater foreends offer your AR type firearm unlimited mounting options for sights, scopes, grips, lights, lasers, etc. Venting slots all around aid in barrel cooling, and rail front edges are drilled and machined to accept the B.M.A.S. Swivel Sling Stud (Note: That stud would not function as a bipod mounting point). These forends are machined from aircraft quality aluminum and hardcoat anodized to mil. specs. The rifle model fits 20" and longer barrels; the carbine version is designed for 16" barrels. Assemblies include forearm, barrel nut and jam nut. **Note: Barrel disassembly is required for installation.**



B.M.A.S. 4 Rail Forearm for RIFLES... \$199.95 (YHM-9480)

B.M.A.S. 4 Rail Forearm for CARBINES... \$139.95 (YHM-9479)

BUSHMASTER MODULAR ACCESSORIES...

B.M.A.S. Multi-Rail Flat-top Riser... \$109.50 (YHM-9492) This multi rail riser for the AR-15 flat-top clamps onto the receiver's rail to allow see-thru use of existing iron sights while offering multiple rail platforms for optics, lights, lasers or night vision devices. It includes threaded holes for a sling mount studs on either side, and is machined of aircraft aluminum with a hard anodize finish.



B.M.A.S. Handguard Rails... \$56.95 (YHM-Hgd-Rail-Rif) Add an auxiliary mounting point to any standard handguards with these new BMAS Rails. With a size to fit either rifle or carbine length handguards, you can clamp any rail mount accessory to these Picatinny configuration anodized aluminum rails. They require removal of the handguard and it's inner shield, then they screw through the existing vent holes. The rails are tapered so that mounted accessories will be on a level plane with the barrel and bore, and they have vent holes that line up with the venting holes in the handguards to avoid interfering with barrel cooling.



Also, the car length rail will fit on a rifle length handguard. They accept all the forward grips, flashlights, rail covers etc. The heat shields may need to be removed on some types of handguards - if the holes of the shields and handguards line up, the shields do not need to be removed. As handguards have the possibility of movement, we would not recommend installation of optics or lasers on this rails.

B.M.A.S. Handguard Rails - Rifle Length \$56.95 (YHM-Hgd-Rail-Rif)
Carbine Length - \$37.95 (YHM-Hgd-Rail-CAR)

B.M.A.S. Triple Mount Kit...\$69.95 (YHM-639K) A quality multi-purpose accessory mount that clamps to the barrel of your AR rifle and fits around the front sight with three separate rail surfaces to allow mounting flashlights, bipod, laser sights, etc. Designed to fit both Post & Pre-Ban barrels (with bayonet lug), there are inserts included with this kit that allow fitting to either .720" diam. (20"/24") or .740" diam. (14.5"/16") barrels. This triple mount will accept all Picatinny/Weaver base attachments, and is machined from solid, black anodized, aircraft aluminum with Allen head clamping screws.



B.M.A.S. Bipod Adapter

\$29.95 (YHM-638) This attachment will adapt Harris (or other) bipods to the



B.M.A.S. Triple Mount described above. Machined from aircraft aluminum and black anodized to mil. spec., it mounts to any Picatinny or Weaver type rail.

B.M.A.S. SuperLite Barrel Bushings... \$13.25 (YHM-640-4) A new set of bushings is now available to fit the thinner Bushmaster SuperLite Barrels - order in addition to kit above.

B.M.A.S. Tactical Sling Adapter... \$9.95 (Part# 1005-

914-2942-T) This newly designed Tactical Sling Adapter is made for attaching various types of tactical slings - allows mounting either web slings or those that have "lobster claw" type clips. This phosphate finished steel adapter plate replaces the receiver end plate of your telescopic, and allows ambi sling mounting on either the primary, or offside shoulder position for a comfortable "tactical" carry. Stock and rec. extension removal is necessary for installation.



BMAS Front Sling Mount & Accessory Rail... \$73.75 (YHM-9574) Designed to clamp into the standard AR front sight, this mount combines a sling stud on one side and a Picatinny rail section on the other for attachment of a flashlight or laser. Two discs fit into the sight and lock together with Allen head screws. The rail then screws into those and is oriented correctly with the large knurled nut.



All anodized aluminum construction.

BUSHMASTER MODULAR ACCESSORIES...

B.M.A.S. Rail Sling

Mount... \$22.95

(YHM-9485S) Attach your sling to any accessory rail (Picatinny or Weaver type) with this sturdy Bushmaster Modular Accessories System Rail Sling Mount. It is shown here on our B.M.A.S. Triple Mount, or will work with any accessory rail system. It locks onto the rail with one Allen head screw, and includes a swivel sling mount stud.



B.M.A.S. Front Sight Sling Mount...

\$29.95 (YHM-9468)

The Bushmaster Modular Accessories System Front Sight Sling Mount easily installs with 3 Allen screws to position the sling along the side of the front sight for a comfortable carry (shown installed and separately). It includes a swiveling stud which will accept standard quick detach sling mounts.



B.M.A.S. Flip Sight Sling Swivel Stud...

\$4.59 (YHM-9364)

Specially threaded to 3/8 x 24 to fit the B.M.A.S. V Match Front Flip Sight above - accepts any detachable sling swivel (i.e. Uncle Mike's, etc.).

B.M.A.S. Swivel Sling Stud...\$3.99 (YHM-9469) This

swiveling sling mount stud threads into our Four-Rail Forearms and other B.M.A.S. accessories to provide a sling attachment point that won't deflect the barrel when the sling is pulled tight. It swivels 360° - precision machined from steel with a black phosphate finish. Use with any standard quick detach sling loop.



B.M.A.S. Folding Foregrip... \$74.75

(YHM-9640)

The newly designed mounting base on this broomstick style grip incorporates the B.M.A.S. push-button mechanism that locks it down for fast deployment. Base mounts to any Picatinny rail with one Allen head screw - can be mounted to fold forward or back according to personal preference or other accessory usage.

B.M.A.S. Solid Vertical >

Forearm Grip... \$34.95

(YHM-9400)

Designed to mount onto rail type forends, this forearm grip adds stability and helps control muzzle rise in rapid fire situations. Slip it onto the rail and tighten with a few twists.



Bushmaster Modular Accessories System Stock with Receiver Extension Tube and Buttplate Screw...

\$90.75

(Part# YHM-9569K)

This kit is designed for those wishing to swap over completely from a telestock, and includes all necessary parts from the receiver back. This new lightweight buttstock design features a strong shoulder piece affixed to a tubular "body". Slips over your existing receiver extension tube and locks in place with the standard buttplate screw. It is drilled and tapped in 7 locations for easy installation of a sling swivel stud such as the B.M.A.S. Swiveling Sling Stud (#YHM-9469). The tubular body of the stock is rubber covered for non-slip shooting comfort.

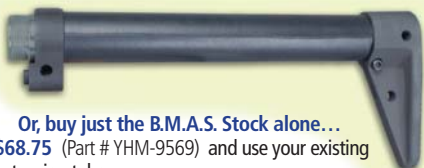

Or, buy just the B.M.A.S. Stock alone...

\$68.75 (Part # YHM-9569) and use your existing extension tube.

< B.M.A.S.

Forward Pistol Grip Assembly...

\$39.95

(9349127-FWDGRP)

This unit combines a rail mount clamp with a standard AR A2 composite plastic pistol grip that allows easy attachment to any Picatinny rail section. A pistol grip forend reduces muzzle rise, and will improve your rifle control.



Bushmaster (B.M.A.S.) 4 Rail Split Handguards...

\$179.00

(YHM-9670)

This beautifully machined set of aircraft quality aluminum handguards will snap right in place of your standard carbine handguards, and offers four full length Picatinny configuration rails to allow mounting any flashlight/laser sight accessories you choose. The top handguard can be used in conjunction with an M203 Grenade Launcher. Finished in mil. spec. black anodize.



BUSHMASTER ACCESSORIES/APPAREL...

This is an economical case for storage, or travel protection for your Bushmaster, or other firearms. With 47" x 9" x 3" dimensions, this case will hold a full sized AR15/M16 rifle, or a scope mounted AR with receivers separated. It's a "clamshell" style design molded of durable black plastic with eggcrate foam lining and four snap closures. You can lock it up with a padlock, and the Bushmaster name is molded into the side panels. Shipping for 1st Case is \$6.95 / Additional Cases: \$5.00 each.

Bushmaster Rifle Case... \$16.95
(Part #10483)



Eagle Padded Rifle Cases for AR Type Rifles & other firearms... \$74.95

Designed for professional use and sewn with craftsmanship and care. Heavy #1000 denier water-resistant black Cordura nylon, with closed cell foam padding for shock protection and additional water resistance, each case features a lockable outside cargo compartment; adjustable magazine pouches; reinforced 2" wide carrying handles; heavy duty YKK zippers; and a 2" wide, padded shoulder strap attached to welded steel D rings. These quality Eagle cases will fit most standard military type AR15/M16 rifles, but are useful as an all around carrying case for other rifles as well. Made by Eagle in the U.S.A.

- **Full Size Rifle Case... \$74.95** (RC-4123) Approx. internal dimensions: 40" x 11" (pictured here)
 - **Carbine Sized Case... \$74.95** (RC-36) Approx. internal dimensions: 36" x 11" (like logo'd case below)
 - Also, • **30" Carbine Sized Case... \$74.95** (RC-3223) To fit FNC & LAR Para 30", Tele AKs
 - **Extra Long Barrelled Rifle Case... \$74.95** (RC-4608) Approx. internal dimensions: 45" x 10"
- This case will also fit FAL 44 1/2" & LAR-HB 45" rifles



Bushmaster Logo Embroidered Carrying Cases...



Shown at the left is our Bushmaster logo embroidered Carbine Case. Approx. internal dimensions: 36" x 11"

- **Carbine Logo Case... \$79.95** (RC-36A)
- **Rifle Logo Case... \$79.95** (RC-4123A)

Similar to the carbine case shown left, with the Bushmaster logo embroidered in red and white. Same quality features and construction as described above. Approx. internal dimensions: 40" x 11"

Discreet Carrying Case for Carbines...



When low profile is needed and personal protection has to be readily available, this 32" black Cordura case does the job. Includes four interior magazine pouches (for up to 40 round mags) and a padded outside pocket for accessories. Approximate internal dimensions: 32" x 13"

- **Discreet Case for Carbines... \$79.95** (DC-CAR-15)
- **Discreet Case for Rifles... \$79.95** (DC-M16/AR15)

A similarly styled model with inside dimensions of approx. 41" x 13" designed the full sized AR15/M16.

- **Discreet Case for Uzi Short Bbl. SMG's... \$79.95** (DC-22) Approx. internal dimensions of 22" x 11"

.22LR Caliber Conversion Kit for AR15/M16... \$159.95 (JAC-008A)

Use .22LR ammo for target practice or plinking in your XM15 - AR15 - M16. This conversion kit contains all parts necessary to convert your rifle from gas operated 5.56mm/.223 Rem. to .22 Rimfire "blowback" operation. It eliminates overpower for indoor ranges and decreases noise in populated areas. No permanent changes are made to your rifle and it can be quickly returned to centerfire configuration. All parts manufactured of heat treated 4040 chromoly steel. Includes Instruction Manual, Blowback Bolt, Hard Plastic Case and 10 Round Magazine. Made in U.S.A.

- **Spare 10 Round Magazines... \$39.95 each** (JAC-005A)



BUSHMASTER ACCESSORIES/APPAREL

Streamlight M-6 Tactical Laser Illuminator... Streamlight's rugged targeting laser/flashlight combination features a 4 position master switch (flashlight illumination only / visible laser only / both / off); a Halogen lamp and two 3 volt Lithium batteries all in a small (3.4" x 1.57" x 1.9") and lightweight (3.7 oz.) black polymer case. It is designed to slide onto any Picatinny type rail or use the bolt-on AR mount on standard handguards (as shown here - mount shown below left). Also available is an optional Remote Pressure Pad On-Off Switch (as shown on this carbine). A "flashlight only" model - the Streamlight M-5 - is very similar, and lighter (3.3 oz.). Also, either the M-5 or M-6 models can be easily adapted to pistol use.



STREAMLIGHT

Streamlight M-6 Tactical Light/Laser w/batteries... \$415.00 (SL-M-6)

Streamlight M-5 Tactical Light w/batteries... \$234.95 (SL-M-5)

< Remote Pressure Pad On-Off Switch... \$70.00 (SL-PresPad)

This adhesive backed pressure pad switch (shown at left) can also be used with the Streamlight M-3 and M-5 Tactical Lights.



Streamlight M16/AR15 Tactical Light Mount... \$19.95 (SL-Mount)

This Picatinny Rail section bolts onto standard handguards (through the vent holes) with its supplied inner reinforcing plate.



The Bushmaster Gun Pad... \$9.95 (QP-014) It's a sturdy counter-top protector for gunsmithing assembly work that doubles as a computer mouse pad. This big (18" x 12") brightly colored pad has crisp images of the Bushmaster family of rifles. It's surface is laminated and the backing is soft, non-skid foam padding.



The "Life Jacket" Safety Device for AR15/M16 Rifles... \$29.95 (LJ-1) "More secure than a Trigger Lock - more portable than a Safe" Lock up your prized AR with the Life Jacket. It's a tough polycarbonate clamshell enclosure that covers the entire action of the rifle. Two separate keyed locks and keys are included. The Life Jacket features a foam padded interior to protect your rifle's finish, and dual, tamper resistant hinge pins. It will secure almost all AR type rifles - with fixed carry handle or removable; all barrels with standard or DCM type free-floater forearms. **Note: To use the Life Jacket on a rifle with our V Match tubular aluminum forend, some material will have to be removed from the front opening.**

M7 Bayonet with M10 Scabbard... \$29.95 (GC-BAYO SCAB KIT) Fits Pre-Ban AR15/M16 and AR180. A quality Gov't. type Bayonet and Scabbard - made in the U.S.A. ...



Bushmaster Logo Mug... \$4.95 (QP-016) Will your shot groupings improve if you drink coffee from this black ceramic mug with our Bushmaster screen printed logo? We certainly hope so - let us know!

Bushmaster Logo Decal... \$1.95 (QP-013)

4 1/2" wide, screen printed red and black on white vinyl with adhesive backing.



Bushmaster Sighting-in Targets... \$2.95 (QP-015K)

One dozen 25 meter targets with instructions to get your rifle zeroed in right!

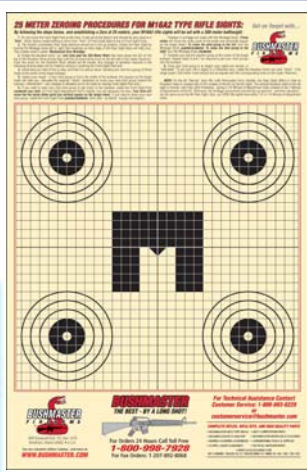

BUSHMASTER ACCESSORIES/APPAREL...

Bushmaster Embroidered T-Shirt... \$14.95 Heavy-weight quality, 100% white cotton T-Shirt with red and black Bushmaster logo in on the upper left chest.



Order Part # QP-007 followed by size: M-L-XL or XXL

Bushmaster Caps... \$9.95 ea. We've embroidered our logo onto a soft brushed twill khaki tan cap or our traditional black baseball style cap. The embroidery is in red & white, or red, black and white, depending on hat color. They're durable, comfortable, and have an adjustable strap so that one size fits all.

Black Cap... \$9.95 (QP-001) / **Tan Cap... \$9.95** (QP-001T)

Bushmaster Fleece Lined Jacket... Lots of the folks at the factory stay warm all the Maine winter long with this Bushmaster logo embroidered jacket. It's Toughlan® nylon shell is wind-proof and water resistant, it has a winter weight 11.5 oz. fleece lining and 3 zippered pockets (2 outer/1 inner) and our Bushmaster logo is embroidered in red and white on the left chest. Available in Black with black fleece lining, or Khaki Tan with green fleece lining. Order by the part numbers shown below followed by your size: S - M - L - XL - 2XL - 3XL - 4XL - 5XL.

Black... \$69.95 (QP-8800BB & size) / **Khaki... \$69.95** (QP-8800TG & size)

Bushmaster Logo Patch
Three color embroidered patch - great for sewing onto your shooting jacket, range bag, etc. Show your Bushmaster loyalty! 3" wide x 2" high. **\$2.95** (QP-012)



Bushmaster Screen Printed T-Shirts...



Quality 50/50 Blend T-Shirts in White or Black with the Bushmaster logo silkscreened in two colors on the front left breast, and larger logo variations on the back (see photos at left). Order with Part Numbers below followed by size: S - M - L - XL or XXL.

Black T-Shirt... \$15.95 (QP-003 & size)

White T-Shirt... \$15.95 (QP-003W & size)

Bushmaster Sport Shirts... A 50/50 blend knit sport style shirt with collared, three button neck, available in either white or black. The Bushmaster logo is embroidered in two colors on the left breast. Comfortable, durable, and great for the field, range or sporting event. Order with Part Numbers below followed by size: S - M - L - XL or XXL.

White - \$24.95 (QP-002W & size) / **Black - \$24.95** (QP-002 & size)



Bushmaster Sweat Shirt... Heavy Jerzees
"Super Sweats" crewneck pull-overs (50% cotton /50% polyester) with Bushmaster's snake logo embroidered upper left chest. Choose from Khaki Tan, Black, or Gray. Order with part numbers below and your choice of size: S - M - L - XL or XXL.

Khaki Tan... \$27.95 (QP-021K & size)

Black... \$27.95 (QP-021B & size)

Gray... \$27.95 (QP-021G & size)



Customer Service, Exchanges, Backorders, Gunsmithing, Bushmaster Warranty...

CUSTOMER SERVICE... Our telephone personnel are highly experienced and well informed firearms enthusiasts. If you have any questions about Bushmaster products, you'll find a courteous member of our firm willing and able to answer them - just call our **Toll-Free Customer Service line (1-800-883-6229)** between 8:30 am - 6:00 pm, Monday through Friday, (E.S.T.). We will also be happy to promptly answer your questions, or order inquiries, via E-mail to: Customerservice@bushmaster.com

EXCHANGES... Should items you order from Bushmaster not be to your expectations, please contact our customer service department for a **Return Authorization Number**. Unused items may be returned within 30 days, include a copy of your invoice. **Note: Any custom barrel assembly not shown in catalog may not be returned.** No refunds allowed after 15 days of invoice date. Restocking charge 20%. Include invoice with your return - its upper left corner can be used as return label. Return all pieces of kits - wrap and package them securely. Insure package for your protection. Include the reason for return of each item in an accompanying letter and we will do everything possible to speed your exchange.

BACKORDERS... We make every attempt to deliver your order from available stock - immediately. Should there be a backorder on a part, we'll ship the bulk of your order and WE pay the shipping on the backordered part (with the exception of complete rifles). UPS Red Label Next Day Service, UPS Blue Label 2 Day Service or UPS Orange Label 3 Day Service are available at additional charge. For C.O.D. Service from UPS, please add \$7.00 per package (**Note: UPS only accepts Postal Money Orders as C.O.D. payment.**)

BUSHMASTER GUNSMITHING... Our company policy is to offer gunsmithing assembly at no charge when parts are purchased from us (with the exception of sight bases). We will also offer our professional gunsmithing services to any customers who care to ship us their firearms or assemblies for repair or buildup - and we will work on brands other than Bushmaster. Gunsmithing time is charged at \$40.00 per hour, and we charge a flat \$15.00 fee for return shipping of your rifle, upper or parts. For an estimate on your gunsmithing needs, please call **1-800-998-7928** or E-mail to: Techsupport@bushmaster.com

BUSHMASTER LIMITED ONE YEAR WARRANTY... Bushmaster Firearms, Inc. firearms are warranted to be free from defects in materials and workmanship. Any such defect of which Bushmaster Firearms, Inc. is given written notice, as provided below, within one year and ten days from the date of first purchase by a customer will be remedied by Bushmaster Firearms, Inc.

This warranty is granted by Bushmaster Firearms, Inc., P.O. Box 1479, 999 Roosevelt Trail, Windham, ME 04062.

To initiate a Warranty claim, call Bushmaster Customer Service (toll free: 8:30 AM to 6:00 PM E.S.T. - Monday thru Friday - **1-800-883-6229**) to get a "Return Authorization Number" (RMA number). Warranty claims should state (in writing) the model and serial number of the firearm concerned, a description of the difficulty experienced, and the date of purchase. The firearm concerned should be shipped (transportation charges prepaid), to the **Warranty Service Department, Bushmaster Firearms, Inc., 999 Roosevelt Trail, Windham, ME 04062.** Firearm shipment should be insured by the owner, as Bushmaster Firearms, Inc. will accept no responsibility for loss or damage in transit.

Shipping and insurance charges for the return of a firearm to its owner will be paid by Bushmaster Firearms, Inc. if the related claim is a proper claim for warranty work.

Under no circumstances shall Bushmaster Firearms, Inc. be responsible for incidental or consequential damages with respect to economic loss or injury to property, whether as a result of express or implied warranty, negligence or otherwise. Some states do not allow the exclusion of limitation of incidental or consequential damages, so the above limitation may not apply to you. Bushmaster Firearms, Inc. will not be responsible for the results of careless handling, unauthorized adjustments, defective, low quality, reloaded, or improper ammunition, corrosion, neglect, ordinary wear and tear, or unreasonable use. Furthermore, the liability of Bushmaster Firearms, Inc. under this warranty shall be limited solely to the obligation to repair or replace the firearm, and to pay transportation and insurance charges for return of the firearm to owner.

NOTE: Handguns and long guns are classified as FIREARMS or DANGEROUS WEAPONS. Guns are surrendered by Bushmaster Firearms, Inc with the express understanding that it assumes no responsibility for resale handling under local laws and regulations.

NOTE: The sale of assemblies in "Pre-Ban" configurations (i.e. with bayonet lugs, flash suppressors, telescoping stocks) are for use as replacement parts only. Such assemblies MAY NOT be used to create new assault weapons as defined by the Gun Legislation of 1994.

NOTE: Regarding Lead... Discharging firearms in poorly ventilated areas, cleaning firearms, or handling ammunition may result in exposure to lead, a substance known to cause birth defects, reproductive harm, and other serious physical injury. Have adequate ventilation at all times. Wash hands thoroughly after exposure to lead.

Ship To:

You can order on the internet at: www.bushmaster.com

Name: _____ Customer No.: _____

(If available - see catalog label)

Address: _____

City: _____

State: _____ ZIP: _____

Telephone Number: () _____ E-mail Address (if available) _____

Phone # and Email are optional. However, if any questions arise about your order, this will assist us in its speedy processing.

Method of Payment: Check or Money Order Enclosed (Personal Checks are held for 15 Days to Clear.)

MasterCard  VISA  American Express  Discover  C.O.D.*

ALL CREDIT CARD ORDERS MUST INCLUDE PHONE NUMBER AND MUST BE SHIPPED TO ADDRESS WHERE CARDHOLDER RECEIVES CREDIT CARD BILLING.

If payment is made with Gift Certificate, please include Certificate Number: _____

Credit Card Account No.: _____ Date of Expiration: _____

Customer's SIGNATURE: _____

Ship Via: UPS (United Parcel Service is our preferred method.) *UPS C.O.D. is available. UPS accepts only Postal Money Orders as C.O.D. payment.

U.S. Mail - PARCEL POST (No C.O.D.s*)

Have you ordered from us before? Yes No Would you like to receive future catalogs?

PAGE NO.	QTY.	PART NO.	DESCRIPTION	PRICE EACH	AMOUNT

Shipping, Handling & Insurance Charges for Parts only - UPS Ground Service or U.S. Mail: **SUBTOTAL**
Other UPS Services (Red/Blue/Orange Label) are available - consult your salesperson.

\$ 0.00 - \$19.99 = \$ 6.50 \$100.00 - \$249.99 = \$13.50 **Maine Residents Add 5% Sales Tax**
\$20.00 - \$49.99 = \$ 8.50 \$250.00 - \$499.99 = \$16.50
\$50.00 - \$99.99 = \$10.50 \$500.00 and up.... = \$19.50 **Shipping, Handling & Insurance**

Standard Rifle - UPS Ground - \$15.00 ea. / DCM Rifle - UPS Ground - \$18.00 **TOTAL AMOUNT**
Pistols must be shipped overnite air. Shipping will be free on backordered "Parts" only.

Shipping Charges on parts orders over 20 lbs. will be calculated by weight only using our UPS published rates plus insurance of .35¢ per \$100.00 value.

UPS C.O.D. Fee - \$7.00 per package. (Note: UPS accepts only Postal Money Orders as C.O.D. payment!)
Call about orders to Hawaii, Alaska and U. S. Territories. We can only ship Pre-Paid via U.S. Mail to Puerto Rico.

SATISFACTION GUARANTEED, OR YOUR MONEY BACK. 999 Roosevelt Trail • P.O. Box 1479 Windham, Maine 04062 U.S.A



ORDERING INSTRUCTIONS / SHIPPING INFORMATION...

FOR FASTEST ORDER PROCESSING, visit our Website and order direct from our online catalog at...

http://www.bushmaster.com Our entire catalog is on the Internet - offering easy and secure ordering without waiting time on the phone! Many of our orders received via Internet are processed and shipped the same day (with the exception of back ordered items). Any orders that include email addresses automatically get a return email confirmation of shipment including the type of shipping service, a UPS tracking number (if applicable), C.O.D. costs (if applicable), and notification of multiple packages. Customer Service and Technical Support inquiries can also be handled quickly and efficiently by email. Contact us at:

Customerservice@bushmaster.com Techsupport@bushmaster.com Export@bushmaster.com

For Telephone Orders, Call: 1-800-998-7928

Sales Consultant Hours: Mon. through Fri. - 8:30 am - 7:00 pm / Sat.- 10:00 am - 3:00 pm
(Eastern Standard or Daylight Savings Time - all other hours of the day by answering machine)

For Orders by FAX: 1-207-892-8068 Customer Service: 1-800-883-6229

(Customer Service Phone Hours: Monday through Friday - 8:30 am - 6:00 pm)

All Catalog Prices are in U.S. Dollars - Please Pay in U.S. Currency

CATALOG PRICES ARE SUBJECT TO CHANGE WITHOUT NOTICE!

Current pricing can be seen on our website - www.bushmaster.com



Please Have Your Credit Card Available. We will NOT charge your credit card until we ship your order! FREE Gunsmithing and assembly is available on most AR15/M16 parts at the time of purchase. We accept purchase orders from Federal, State, and Local Governments and Institutions.



Bushmaster Firearms, Inc. • 999 Roosevelt Trail • P.O. Box 1479 • Windham, ME 04062 U.S.A

SHIPPING... Orders will be shipped promptly via United Parcel Service (UPS) or First Class U.S. Mail. **UPS Red Label Next Day Service, UPS Blue Label 2 Day Service and UPS Orange Label 3 Day Services are available upon request.** All orders must be accompanied with Cash; Credit Card Information; Money Order or Cashier's Check or they will be shipped UPS C.O.D. (C.O.D. to Continental U.S., Alaska and Hawaii and only by UPS - \$7.00 fee extra per package - UPS only accepts Postal Money Orders as payment). We request telephone numbers and/or email address when you order to provide the best possible service in case of questions. In an effort to preserve your privacy, we do not sell our mailing lists. An F.F.L. (Federal Firearms License) is required for the purchase of Complete Rifles, serial numbered Lower Receivers, or M16 components. Other parts and accessories do not require special licenses. Personal checks are held 15 days to clear. No refunds after 15 days of invoice date. Returned parts will incur a 20% restocking charge.

NOTE: UPS now requires "CONFIRMATION DELIVERY" with Receiving Adult Signature Necessary (21 yrs. or older) for any Lower Receiver shipments - from Stripped Lower up to, and including, Complete Rifles. This Adult Signature requirement is a UPS regulation and cannot be waived.

If your UPS Package arrives damaged, you must alert the UPS Driver, or call UPS to notify them of damage problems and to initiate a claim. The UPS toll-free national telephone line for this purpose is 1-800-PICKUPS.

INTERNATIONAL ORDERS... Due to the costs of international order processing, Bushmaster will only accept international orders valued at \$500.00 or more. Bushmaster has established dealers in countries outside the U.S.A., please contact them for your Bushmaster product needs if less than this \$500.00 minimum.

For Shipping Parts Only...

Shipping, Handling & Insurance Charges for UPS Ground Service or U.S. Mail are:

\$0.00 - \$19.99 = \$6.50 / \$20.00 - \$49.99 = \$8.50 / \$50.00 - \$99.99 = \$10.50

\$100.00 - \$249.99 = \$13.50 / \$250.00 - \$499.99 = \$16.50 / \$500.00 and up = \$19.50

For Shipping Complete Firearms...

**Standard Rifle - UPS Ground - \$15.00 ea. / DCM Rifle - UPS Ground - \$18.00
Pistols - by law - must be shipped Overnight Air.**

Free Shipping on backordered "Parts" only. Shipping Charges on parts orders over 20 lbs. will be calculated by weight only using our UPS published rates plus insurance of .35¢ per \$100.00 value.

UPS C.O.D. Fee - \$7.00 per package. **NOTE: UPS will only accept Postal Money Orders as payment for C.O.D.s!**

UPS Red Label Next Day, Blue Label 2 Day and Orange Label 3 Day Services are available upon request.