

2008 – 2009  
BERETTA  
ANNUAL



BERETTA

500 YEARS. ONE PASSION.



At the core of Beretta is a passion.  
An understanding of the wild places. The cold fields of autumn.  
The high grass and the low marsh. Rain and sun. Man and dog.

It's an understanding that is pure and real.  
It lives in the deepest reaches of the hunter's heart.  
The innermost corners of the shooter's soul.  
And it is everywhere.  
A field in Tuscany. A lake in Wyoming. The flash of a tail. The thunder of wings.

And then there is the stirring. The relentless search for balance.  
Between what has gone before and what is yet to be.  
Between then and now and tomorrow.

This is the passion that drives Beretta. It's in our genes.  
And so, too, is it in our hearts. It's why we exist.  
And it's why we have endured for nearly 500 years.  
Because of one purpose. One passion.

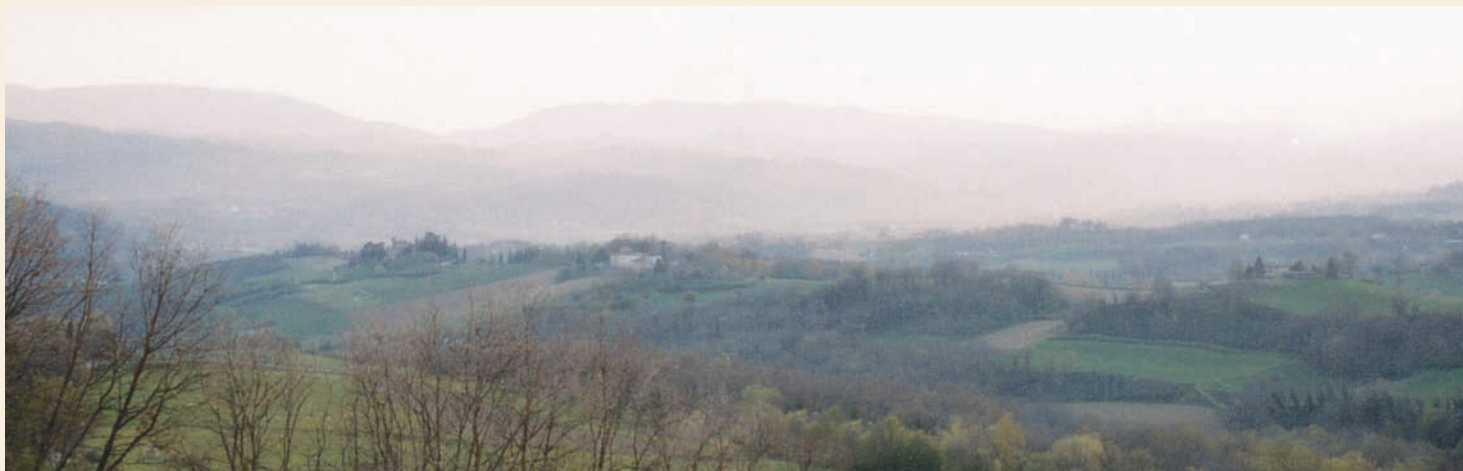

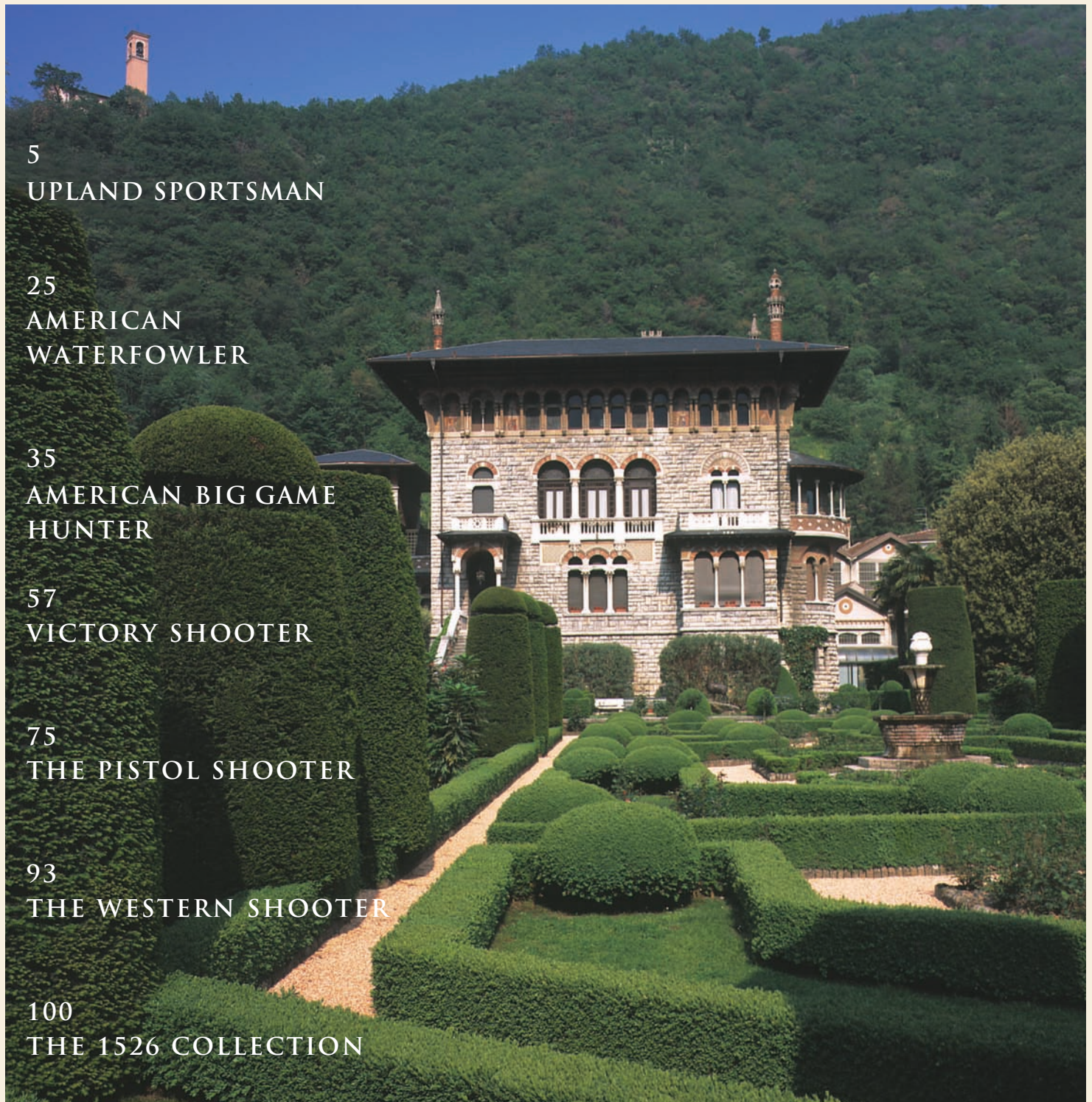

5  
UPLAND SPORTSMAN

25  
AMERICAN  
WATERFOWLER

35  
AMERICAN BIG GAME  
HUNTER

57  
VICTORY SHOOTER

75  
THE PISTOL SHOOTER

93  
THE WESTERN SHOOTER

100  
THE 1526 COLLECTION

GARDONE VAL TROMPIA (ITALY)—VIEW OF THE FACADE OF THE "VILLA BERETTA," ONCE THE MAIN LIVING QUARTERS OF THE BERETTA FAMILY.

Specifications are subject to change without notice.

The following names appearing throughout this document are registered trademarks or copyrights: Beretta®, PB®, World of Beretta®, GORE-TEX®, Statesman™, Citizen™, Ambassador™, Cheetah®, Security Pack®, Cx4 Storm®, Vertec®, Xtrema®, Optimachoke®, Optima-Bore®, Coolmax®, Realtree Hardwoods® HD™, Advantage®, MAX-4 HD™, eXo-mesh™, Teflon®, Vislon®, Truglo®, Thermore®, Polartec®, Cordura®, Federal Premium®, FinSoft®, Memory System II™, Weaver®.



UGO GUSSALLI BERETTA, HIS SON FRANCO, AND GRANDSON CARLO ON A COLD HUNTING DAY NEAR CREMONA, NORTH ITALY.



BERETTA  
A FAMILY TRADITION

La Presidenza  
Fabbrica d'Armi Pietro Beretta S.p.A.  
Via Pietro Beretta, 18  
25063 Gardone Val Trompia  
Brescia, Italy

Dear Friends,

Welcome to the 2008 Beretta Annual. It is with great pleasure that I introduce this book and the family of Beretta products that showcase our unwavering commitment to master craftsmanship, absolute reliability, and industry-leading innovation. In a year in which we once again expect to see Beretta firearms accompany the world's best shooters atop the Olympic medal stand, you will see that we have not for a moment rested on our laurels. We continue to be driven to bring you newer and better firearms, and the accessories that accompany them.

You see, we have a passion for everything that we do. You can see it in the details of our products and in our commitment to our customers. It is not enough to make the best firearms; we must also respond to our customers' needs and provide them with everything it takes for them to pursue their passions.

We are more committed than ever to the sporting life. In these pages you will find products that are a true reflection of who we are. We live, love, and believe in what we do. Just like you, the Beretta family's outdoor pursuits are wide ranging: upland, big game, waterfowl, competition shooting, Western and more. Because of this, we are committed to bringing you all-inclusive collections of firearms, apparel, and accessories — designed to complement each other and suit each individual's particular need.



Cav. Ugo Gussalli Beretta  
President, Fabbrica d'Armi Pietro Beretta S.p.A.







INTRODUCING  
UPLAND SPORTSMAN

Whether it's aspens and alders that hide the darting flight of woodcock and grouse — or the open grass plains of pheasant and quail — you are in your element. The crisp fall morning air heightens your senses as the sun warms your face. You once again marvel at the gracefulness of your trusty German Shorthair at rock-solid point. It is a scene you've both played out many times before. Yet it feels as fresh and exhilarating as the first time you swung your shotgun towards the skies. No matter the day's result, this is reward enough.

These moments are what bring you back season after season. A respect for nature, harmony, and heritage are the hallmarks of the Beretta Upland Sportsman. Hallmarks that are reflected in Beretta's superb collection of fine shotguns perfectly suited for their purpose in the field, superior upland apparel designed to meet the challenges of nature, and accessories that perfectly complement your passion and pursuit.

UPLAND SPORTSMAN

## SV10 PERENNIA

DESIGNED TO PERFORM. THE REVOLUTIONARY SV10 PERENNIA.



## SV10 PERENNIA

### SV10 PERENNIA JV13A18

Every once in a generation or so comes along a shotgun that revolutionizes and reshapes the category. Beretta's SV10 Perennia is such a firearm. The third evolution of Beretta's celebrated over-and-unders, its lineage springs from the elegant and high performance SO10.

Like its root word, perennial, it has been meticulously engineered for reliable performance, year after year, round after round. The Perennia's new aesthetics and technical design are unmatched anywhere. A redesigned safety offers a better grip and ergonomics, while a new locking system provides a more constant lock between the stock and receiver. From its deeper, more elegant breech shoulders and wide ellipse for clear, richer engravings to its innovations like the first ever application of Kick-Off technology in a wooden stock, this is a world-class gun that will outperform your expectations.



The receiver, while maintaining the traditional Beretta locking system with trapezoidal shoulders and double longitudinal locking lugs, is characterized by arrowhead-shaped sideplates that stand out from the sides. The locking shoulders of the monobloc and their corresponding seats on the receiver feature new, larger shapes that are not only better integrated into the design of the sideplates, but also improve the efficiency of the lock-up. The styling refinements continue into the shape of the stock inletting, which now moves well forward into the sides of the receiver, consolidating the rigidity of the assembly.



The new profile of the barrels also unifies form and function: The tubes elegantly blend with the receiver and ensure excellent strength and durability.

The top moldings integrate gracefully with the style of the receiver, while guaranteeing an improved field of view when sighting.

Machined from a solid steel alloy billet, hardened and tempered, the Perennia's over-and-under receiver provides a low and elegant profile that allows the redirection of the recoil in-line to the shooter's shoulder. This reduces the felt recoil and eases shouldering.

The high-strength alloy receiver is treated with an exclusive, nickel based, protective finish that increases its durability and resistance to corrosion.



SV10 PERENNIA



**KICK-OFF**



**BERETTA Q-STOCK,  
PATENTED QUICK TAKE-DOWN STOCK**

The new profile Q-Stock features an exclusive attachment system to the receiver, patented by Beretta, which allows its disassembly in just a few

seconds – for replacement, special work or access to the trigger mechanism – without having to remove the recoil pad. This new Q-Stock design no longer requires the traditional internal through-bolt since it attaches directly to the receiver, increasing the solidity of the receiver-stock assembly. The result is a lock-up that is constant over time, also contributing to extending the life of the shotgun. The disassembly operation is executed using the included special key, inserting it through the grip cap which features an elegant and functional hinged coverplate.

**REMOVABLE TRIGGER GROUP**

Once the stock is removed, even the trigger group may be quickly removed in order to have access to all of its components for cleaning or maintenance. The disassembly may be performed with the same tool used to detach the stock.

**TITANIUM TRIGGER**

The Beretta Perennia is formed from solid, lightweight, titanium. This premiere material guarantees the durability and reliability of use. The mirror polish highlights the harmony of its shapes.



**TRIGGER GUARD AND TRIGGER PLATE**

The strong trigger guard, machined from a single piece of steel, elegantly blends into the trigger plate via two rounded reinforcement ridges. Even in this case form and function are wisely intertwined.

**REINFORCED HINGE PINS**

Well proportioned yet characterized by a significant size, the hinge pins, also thanks to a new special internal reinforcement shoulder, offer the maximum resistance to the stress of years of use. Positioned as close as possible to the lower barrel axis, the pins allow the compactness, elegance and strength of the receiver.

**NEWLY DESIGNED SAFETY/SELECTOR LEVER**

New top lever design. The newly designed top lever features a wide surface area to ensure ease and comfort of operation. The design of the safety/selector assembly has been executed with attention to the smallest detail to ensure smooth, precise and secure operation and a constant engagement force. The selector (where present) is integrated into the lever and snaps precisely into one position or the other, avoiding the annoyance of being in a non-firing 'neutral' position and compromising the shot.





## SV10 PERENNIA

### NEW BARREL PROFILE

Manufactured from the highest strength alloys using the exclusive process of cold hammer forging, which guarantees the perfect concentricity of the tubes, the barrels of the new Beretta Perennia are extremely strong yet, at the same time, extremely light. Designed to be able to withstand the rigors of steel shot, they feature a new internal Optima-Bore HP (High Performance) profile with a longer forcing cone which improves patterning and contributes to reduce felt recoil. The bore and chamber are completely chrome-lined to guarantee maximum resistance to corrosion and wear, and to increase the velocity of the shot. The new profile of the barrels joins form and function: The tubes blend harmoniously with the monobloc, mating the streamlined profile of the receiver and, at the same time, ensuring excellent durability and strength. The external surfaces of the barrels are finished in a resistant polished bluing.

### NEW LONG GUIDED EXTRACTORS

The newly designed extractors are precisely guided along the entire length of the barrel monobloc to ensure impeccable extraction or ejection of the shells. The large contact surface area of the extractors on the rim of the shell improves its retention and reliability.

### SPECIAL 'ENVIRONMENTALLY FRIENDLY' EXTRACTION SYSTEM

In the new Perennia over-and-under, Beretta introduces a new patented extraction system that allows the selection between automatic ejection or simple mechanical extraction of the fired shells. The selector is easily accessed by simply removing the fore-end.

### NEW BERETTA OPTIMACHOKE® HP CHOKE TUBES

The new flush Beretta Optimachoke® HP (High Performance) choke tubes feature an internal profile to reduce friction and improving the density and distribution of the pattern. Manufactured from high-strength steel and finished in a nickel-alloy coating, the Beretta Optimachoke® HP chokes guarantee significant corrosion resistance and ability to withstand the rigors of steel shot.



SV10 PERENNIA	
ENGRAVING	LASER ENGRAVED GAME SCENE, NICKEL HIGH PHOSPHOROUS BASED PROTECTIVE FINISH
GAUGE	12
CHAMBER	3"
WOOD FINISH	NEWLY DESIGNED CHECKERING/ MATTE OIL FINISH ON SELECT WALNUT
STOCK DROP - COMB	1.50"
STOCK DROP - HEEL	2.36"
BUTT PLATE	FULL BLACK RUBBER RECOIL PAD INCLUDED
SAFETY	AUTOMATIC SAFETY, NEWLY DESIGNED SAFETY AND SELECTOR LEVER
TRIGGER	TITANIUM SINGLE SELECTIVE - REMOVEABLE TRIGGER GROUP
FORE-END	NEWLY DESIGNED SEMIBEAVERTAIL FORE-END WITH ELONGATED FORE-END LEVER
RIB TYPE	FLAT 1/4" X 1/4"
SIGHT	METAL FRONT BEAD
ACCESSORIES	POLYPROPYLENE CASE, 5 CHOKES WITH SPANNER, SLING SWIVELS, PLASTIC PAD
LENGTH OF PULL	14.7"
BARRELS	NEW OPTIMA-BORE HIGH PERFORMANCE PROFILE
BARREL LENGTH	26", 28"
EXTRACTION SYSTEM	LONG GUIDED EXTRACTORS, EASY SELECTION BETWEEN AUTOMATIC EJECTION OR MECHANICAL EXTRACTION

\*WEIGHTS ARE APPROXIMATE, DEPENDENT ON WOOD DENSITY AND BARREL LENGTH.

### NEW FORE-END AND FORE-END IRON

The fore-end, streamlined and elegant, features new ergonomic shapes that guarantee its optimal grip. The new fore-end iron boasts a new patented internal mechanism that maintains a constant barrel-receiver-iron fit. This system further contributes to improve the strength of the locking system and the service life of the gun. The new fore-end lever, with its elongated shape, ensures the smooth release of the fore-end from the barrel.



### KICK-OFF® RECOIL REDUCTION MECHANISM

The new patented Kick-Off® mechanism (on select models only) was conceived to significantly reduce the felt recoil to the shooter's shoulder. Thanks to Kick-Off®, the recoil energy is gradually dissipated through two oil hydraulic dampeners integrated into the design, with obvious increased comfort to the shooter. At the same time, the vibrations and the muzzle rise are decreased, and the durability, reliability and handling of the firearm are enhanced.





# 687 EELL DIAMOND PIGEON



### 687 EELL DIAMOND PIGEON J6873A0

In Italian, EL stands for *extra lusso* (extra luxury). The EELL designation takes that quality to an even higher level. This is an over-under with the feel and allure of a classic game gun for the discriminating sportsman who appreciates all the finer points of a well-made shotgun. The patented locking system creates a particularly slim receiver, making it one of the most elegant, finely balanced and responsive shotguns in the world. The extensive hand-chased engraving, combined with the highly figured oil-finished walnut, makes a classic statement of your good taste. The 687 EELL Diamond Pigeon is also available in 20/28 gauge Combo set.



The sideplate design gives the engraver full scope for his craft. When combined with fine walnut, nothing is quite so pleasing.

### 687 EELL DIAMOND PIGEON COMBO

ACTION	LOW PROFILE, IMPROVED BOX LOCK
GAUGE	12, 20, 28, .410
CHAMBER	3" (28 GAUGE 2¾")
WOOD FINISH	OIL
STOCK/FORE-END	HIGHLY SELECTED WALNUT, CHECKERED
STOCK DROP - COMB	1.50**
STOCK DROP - HEEL	2.36**
BUTT PLATE	FULL BLACK RUBBER
SAFETY	AUTOMATIC
TRIGGER	SINGLE SELECTIVE
FORE-END	SCHNABEL
RIB TYPE	FLAT ¼" X ¼"
SIGHT	METAL FRONT BEAD
WEIGHT	6.8 LBS (12 GAUGE)
CARRY CASE	YES

\*ENGLISH STOCK VERSION IS 1.38" - COMB, 2.17" - HEEL.  
 \*\*WEIGHTS ARE APPROXIMATE, DEPENDENT ON WOOD DENSITY AND BARREL LENGTH.

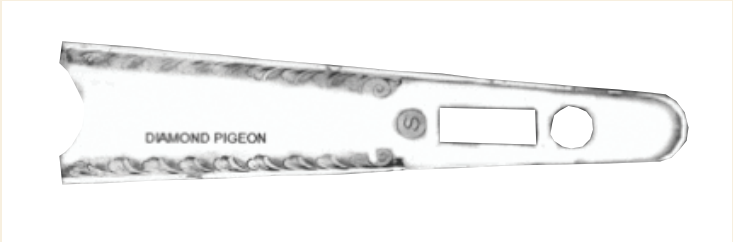

The rich hand-chased engraving extends to the trigger plate and trigger guard.



## 687 SILVER PIGEON FAMILY

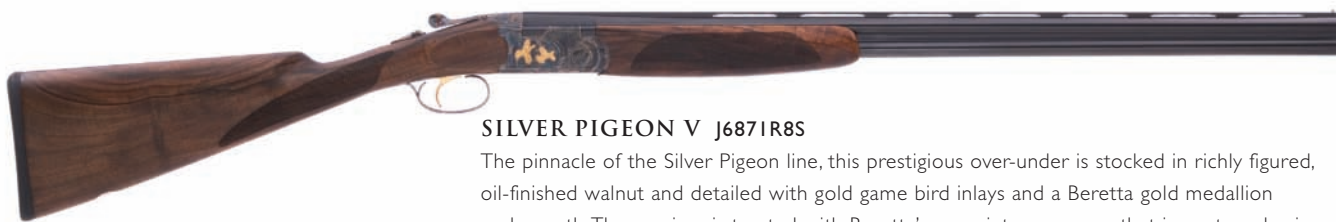

### SILVER PIGEON V J6871R8S

The pinnacle of the Silver Pigeon line, this prestigious over-under is stocked in richly figured, oil-finished walnut and detailed with gold game bird inlays and a Beretta gold medallion underneath. The receiver is treated with Beretta's proprietary process that imparts a classic color-case finish that ensures metallurgical integrity and a distortion-free part. A joy to own and shoot, thanks to Beretta's superior mechanical refinement and innovative technology, the Silver Pigeon V will last for generations.



### SILVER PIGEON IV J6871B8

Beretta shotguns are carried with pride on every continent. The Silver Pigeon IV is expressly styled to satisfy those who desire a classic blued finish. In contrast to most Beretta over-unders, it has a rich, classic black frame, accented by gold inlays that reflect the typical quarry for each gauge. It's a striking gun that stands out — even among other Berettas.



### SILVER PIGEON III J6871J8

There's no need to sacrifice style for function with this attractively priced member of the Silver Pigeon family. The distinctive Silver Pigeon III has all the features of the S and II, but with more extensive engraving, including game scenes, on the frame. Available in a trim and racy 28-gauge made on its own properly scaled frame, this finely crafted shotgun with natural pointability is up to any hunting challenge.

	SILVER PIGEON V	SILVER PIGEON IV	SILVER PIGEON III
<b>ACTION</b>	LOW PROFILE, IMPROVED BOX LOCK		
<b>GAUGE</b>	12, 20, 28 AND .410	12, 20, 28	12, 20, 28
<b>CHAMBER</b>	3"	3"	3"
<b>WOOD FINISH</b>	OIL	OIL	OIL
<b>STOCK/FORE-END</b>	SELECTED WALNUT, CHECKERED		
<b>STOCK DROP - COMB</b>	1.50"	1.50"	1.50"
<b>STOCK DROP - HEEL</b>	2.36"	2.36"	2.36"
<b>BUTT PLATE</b>	FULL BLACK RUBBER	GEL-TEK RECOIL PAD	
<b>SAFETY</b>	AUTOMATIC		
<b>TRIGGER</b>	SINGLE SELECTIVE		
<b>RIB TYPE</b>	FLAT ¼" X ¼"		
<b>SIGHT</b>	STEEL FRONT BEAD		
<b>WEIGHT</b>	6.8 LBS (12 GAUGE)		

WEIGHTS ARE APPROXIMATE, DEPENDENT ON WOOD DENSITY AND BARREL LENGTH.



## 687 SILVER PIGEON



### 687 SILVER PIGEON II J687155

Designed to perform, the Silver Pigeon II is also as beautiful to the eye as it is to the touch. The oil-finished stock is select walnut with a traditional Schnabel fore-end; bold game scene engraving separates it from other shotguns. This over-under also enjoys the Beretta's legendary pointability, thanks to the 680 series low-profile receiver. Furthermore, the absolute strength of the unique locking system provides for years of trouble-free use. Also available in 20/28 gauge combo set.

## 686 SILVER PIGEON S



### 686 SILVER PIGEON S J68652

With the same level of mechanical refinement as Beretta's higher end over-unders, this entry-level shotgun offers an economical way to enjoy both the aesthetics and quality of a prestigious Silver Pigeon. The extensive floral and scroll engravings are executed on a satin nickel-alloy finished receiver that is exceptionally resistant to wear and corrosion. And the dual-cone locking mechanism stands up to years of constant shooting.



	686 SILVER PIGEON S	686 SILVER PIGEON II
<b>ACTION</b>	LOW PROFILE, IMPROVED BOX LOCK	
<b>GAUGE</b>	12, 20, 28, .410	12, 20, 28
<b>CHAMBER</b>	3" (28 GAUGE 2¾")	
<b>WOOD FINISH</b>	OIL	OIL
<b>STOCK/FORE-END</b>	SELECTED WALNUT, CHECKERED	
<b>STOCK DROP - COMB</b>	1.50"	1.50"
<b>STOCK DROP - HEEL</b>	2.36"	2.36"
<b>BUTT PLATE</b>	FULL BLACK RUBBER	
<b>SAFETY</b>	AUTOMATIC	AUTOMATIC
<b>TRIGGER</b>	SINGLE SELECTIVE	SINGLE SELECTIVE
<b>FORE-END</b>	SCHNABEL	
<b>RIB TYPE</b>	FLAT ¼" X ¼"	
<b>SIGHT</b>	METAL FRONT BEAD	
<b>WEIGHT</b>	6.8 LBS (12 GAUGE)	6.8 LBS (12 GAUGE); 6.2 LBS (20 GAUGE)
<b>CARRY CASE</b>	YES	YES

WEIGHTS ARE APPROXIMATE, DEPENDENT ON WOOD DENSITY AND BARREL LENGTH.



## 687 ULTRALIGHT FAMILY



### ULTRALIGHT DELUXE J687575

When game trails are long and terrain is rugged, every ounce comes to tell as the hours pass. The Ultralight is a 12 gauge that carries like a small bore. The key to the Ultralight's feathery feel is a light but strong aluminum frame, reinforced at the breech face and shoulders with hard, durable titanium. In this Deluxe version, Beretta has added highly figured oil-finished walnut stock and full floral engraving with gold-filled game birds.



### ULTRALIGHT J687559

Like the Ultralight Deluxe, this sturdy over-under will help you stay afield. The lightweight aluminum and titanium alloys keep weight to the very minimum while preserving the smooth, sure handling you expect from a Beretta. The Ultralight has a semigloss-finished walnut stock with a Schnabel fore-end. Its receiver is distinctively decorated with the very game birds a hunter might pursue with Ultralight in hand.



Why low profile? Beretta's box lock mechanism allows a lower profile receiver. This benefits the shooter's accuracy, providing improved hand-to-eye coordination for instinctive shooting.

	ULTRALIGHT DELUXE	ULTRALIGHT
<b>ACTION</b>	LOW PROFILE, IMPROVED BOX LOCK	
<b>GAUGE</b>	12	
<b>CHAMBER</b>	2¾"	
<b>WOOD FINISH</b>	OIL	SEMIGLOSS
<b>STOCK/FORE-END</b>	HIGHLY SELECTED WALNUT, CHECKERED	SELECTED WALNUT, CHECKERED
<b>STOCK DROP - COMB</b>	1.50"	
<b>STOCK DROP - HEEL</b>	2.36"	
<b>BUTT PLATE</b>	FULL BLACK RUBBER	
<b>SAFETY</b>	AUTOMATIC	
<b>TRIGGER</b>	SINGLE SELECTIVE	
<b>FORE-END</b>	SCHNABEL	
<b>RIB TYPE</b>	FLAT ¼" X ¼"	
<b>SIGHT</b>	METAL FRONT BEAD	
<b>WEIGHT</b>	6.4 LBS*	
<b>CARRY CASE</b>	YES	

\*WEIGHTS ARE APPROXIMATE. DEPENDENT ON WOOD DENSITY AND BARREL LENGTH.



# 686 WHITE ONYX



### 686 WHITE ONYX J6862K6

At some point in every sportsman's hunting life—whether as a novice or a seasoned shooter in need of an additional gauge—a no-nonsense, versatile tool is called for. The 686 White Onyx, with its streamlined stock design for fast target acquisition, top mounted bolt-lug design for secure barrel lockup, and easy maintenance, fits the bill. The satin nickel frame is accented with Beretta's Dura-Jewel finish for a classic look.

### 686 WHITE ONYX

<b>ACTION</b>	LOW PROFILE, IMPROVED BOX LOCK
<b>GAUGE</b>	12, 20, 28
<b>CHAMBER</b>	3" (28 GAUGE 2¾")
<b>WOOD FINISH</b>	GLOSS
<b>STOCK/FORE-END</b>	WALNUT, CHECKERED
<b>STOCK DROP - COMB</b>	1.50"
<b>STOCK DROP - HEEL</b>	2.36"
<b>BUTT PLATE</b>	FULL BLACK RUBBER
<b>SAFETY</b>	AUTOMATIC
<b>TRIGGER</b>	SINGLE SELECTIVE
<b>FORE-END</b>	SCHNABEL
<b>RIB TYPE</b>	FLAT ¼" X ¼"
<b>SIGHT</b>	METAL FRONT BEAD
<b>WEIGHT</b>	6.7 LBS (12 GAUGE)
<b>CARRY CASE</b>	YES

\*WEIGHTS ARE APPROXIMATE, DEPENDENT ON WOOD DENSITY AND BARREL LENGTH.



Beretta over-unders are known for their slim, low-profile receivers that let the shotgun rest low in the hands for superb pointability.





## 471 SILVER HAWK FAMILY



### 471 SILVER HAWK J471240

Extensive scroll and leaf engraving and a gold-filled hawk's head on the top lever make the 471 Silver Hawk a prestige item you'll be proud to carry in any company. Just like the 471 EL, this side-by-side's frame is made of a steel alloy rich in nickel, chromium and molybdenum for durability and beauty. Both shotguns feature barrels joined to the monoblock by a laser system that creates the strong, secure Beretta barrel assembly.



### 471 EL SILVER HAWK J470335

Combining half a millennium's worth of design skill and craftsmanship with state-of-the-art technology, the classic side-by-side 471 EL Silver Hawk is a hunting arm that is both beautiful and rugged. Its lines and finishes recall the best of a bygone era. The classic English-style buttstock and splinter fore-end are made of oil-finished select walnut. Case-hardened sideplates with Beretta's unique coloring process are decorated with eye-catching gold-filled game bird scenes.



The 12-gauge Optima-Choke tubes feature longer tapered construction, assuring greater pellet concentration and better distribution of shot.



The sideplates are attached without visible screws, for a classic understated look.

### 471 SILVER HAWK

### 471 EL SILVER HAWK

	471 SILVER HAWK	471 EL SILVER HAWK
<b>ACTION</b>	BOX LOCK	
<b>GAUGE</b>	12, 20	12, 20
<b>CHAMBER</b>	3"	3"
<b>WOOD FINISH</b>	OIL	OIL
<b>STOCK/FORE-END</b>	SELECTED WALNUT, CHECKERED	HIGHLY SELECTED WALNUT, CHECKERED
<b>STOCK DROP - COMB</b>	1.50" (1.38" STRAIGHT STOCK)	1.38"
<b>STOCK DROP - HEEL</b>	2.36" (2.17" STRAIGHT STOCK)	2.17"
<b>BUTT PLATE</b>	FULL RUBBER	WOOD BUTT PLATE
<b>SAFETY</b>	AUTOMATIC	AUTOMATIC
<b>TRIGGER</b>	SINGLE, SELECTIVE	SINGLE, SELECTIVE
<b>FORE-END</b>	SPLINTER STYLE (STRAIGHT STOCK) OR BEAVERTAIL (PISTOL GRIP)	SPLINTER STYLE (STRAIGHT STOCK)
<b>RIB TYPE</b>	TAPERED FROM 3/16" TO 7/32"	
<b>SIGHT</b>	METAL FRONT BEAD	METAL FRONT BEAD
<b>WEIGHT</b>	6.5 LBS (12 GAUGE); 5.9 LBS (20 GAUGE)	6.5 LBS (12 GAUGE); 5.9 LBS (20 GAUGE)
<b>CARRY CASE</b>	YES	YES

\*WEIGHTS ARE APPROXIMATE, DEPENDENT ON WOOD DENSITY AND BARREL LENGTH.



AL391 TEKNYS GOLD



**AL391 TEKNYS GOLD J391T36**

The AL391 Teknys Gold brings unmatched design and prestige to the most discriminating autoloader aficionado. Beretta's ultimate field autoloader, this distinctive sporting arm with superb recoil control performs as well as it looks. Its semiautomatic gas system cycles ammunition ranging from feathery target loads to thumping 12-gauge, 3-inch magnums. Select oil-finished walnut buttstock and fore-end with polished side panels are complemented by deeply engraved hunting scenes.



A green enamel inlay at the wrist gives the Teknys a distinctive look.



The buttstock can be adjusted for drop and cast with a supplied shim spacer kit.



**AL391 TEKNYS GOLD**

<b>ACTION</b>	SEMI-AUTOMATIC GAS OPERATION WITH SELF-COMPENSATING EXHAUST VALVE
<b>GAUGE</b>	12, 20
<b>CHAMBER</b>	3"
<b>WOOD FINISH</b>	OIL
<b>STOCK/FORE-END</b>	HIGHLY SELECTED WALNUT, CHECKERED
<b>STOCK DROP - COMB</b>	1.34"
<b>STOCK DROP - HEEL</b>	2.36"
<b>BUTT PLATE</b>	GEL-TEK
<b>SAFETY</b>	CROSS-BOLT, REVERSIBLE FOR LEFT-HANDED SHOOTERS
<b>TRIGGER</b>	GOLD
<b>FORE-END</b>	ULTRA SLIM
<b>RIB TYPE</b>	FLAT 1/4" X 1/4"
<b>SIGHT</b>	METAL BEAD
<b>WEIGHT</b>	7.3 LBS (12 GAUGE); 5.9 LBS (20 GAUGE)
<b>CARRY CASE</b>	YES

\*WEIGHTS ARE APPROXIMATE, DEPENDENT ON WOOD DENSITY AND BARREL LENGTH.



## AL391 URIKA 2 GOLD



12 GA.



20 GA.

### AL391 URIKA 2 GOLD J39TB18

Beretta offers an enhanced version of the award-winning gas-operated semiautomatic that has sold over 1.5 million units worldwide since its introduction. The Urika 2 has several notable features that make it the fastest, easiest, and smoothest handling semiautomatic on the market today. The AL391 Urika 2 Gold features a higher grade of select oil-finished wood stock and fore-end. The upgraded engraving scheme features gold-filled game bird inlays.



### AL391 URIKA 2 GOLD

### AL391 URIKA 2 CLASSIC

ACTION	SEMI-AUTOMATIC GAS OPERATION WITH SELF-COMPENSATING EXHAUST VALVE AND SELF-CLEANING PISTON	
GAUGE	12, 20	12, 20
CHAMBER	3"	3"
BARREL LENGTH	26"; 28" (12 GAUGE ONLY)	
CHOKES	OPTIMACHOKE® PLUS W/12 GA. OR MOBILCHOKE® W/20 GA.	
WOOD FINISH	MATTE	MATTE
STOCK/FORE-END	SELECTED WALNUT	X-TRA GRAIN
STOCK DROP - COMB	1.38"	
STOCK DROP - HEEL	ADJUSTABLE FROM 1.97" TO 2.56"	
BUTT PLATE	FULL BLACK RUBBER OR PLASTIC (20 GAUGE)	
SAFETY	CROSS-BOLT, REVERSIBLE FOR LEFT-HANDED SHOOTERS	
TRIGGER	GOLD	
FORE-END	ULTRA SLIM	
RIB TYPE	FLAT ¼" X ¼"	
SIGHT	METAL FRONT BEAD	
WEIGHT	6.6 LBS; 6.0 LBS (20 GAUGE)	
CARRY CASE	YES	



WEIGHTS ARE APPROXIMATE, DEPENDENT ON WOOD DENSITY AND BARREL LENGTH.



## AL391 URIKA 2 CLASSIC



### AL391 URIKA 2 CLASSIC J39TB18

For Upland hunters, the Urika 2 Classic comes in a standard model that features the new X-Tra Grain wood enhancement treatment — and for the first time on the base Urika — tasteful fine-line scroll engraving on either side panels of receiver.

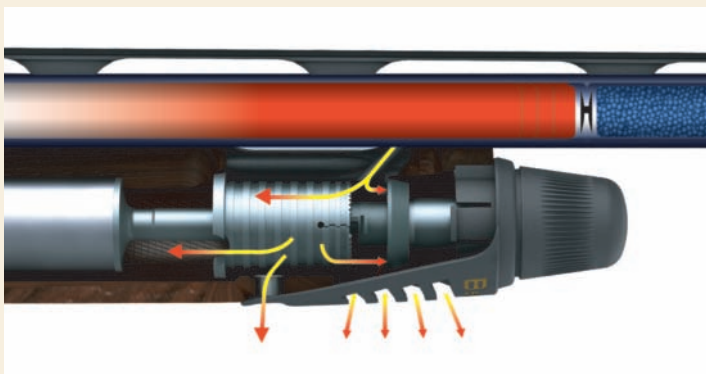

### THE BERETTA GAS SYSTEM IS TWICE AS FAST AS ANY OTHER OPERATING SYSTEM.

The gas system has been improved by the addition of a spinning and self-cleaning action. As gas pressure is fed into the gas cylinder, a series of expandable fingers on the piston move outwardly to clean the gas cylinder as the action cycles. Additionally, the gas piston is imparted with a spinning motion and "scraper teeth" to ensure carbon deposits are thoroughly dislodged and removed from the gas system. This improved cleaning action greatly contributes to enhanced reliability and longer functioning shooting periods between cleaning.



### X-TRA GRAIN

Beretta's proprietary X-Tra Grain wood treatment is standard on classic models. This wood surface enhancement process, applied to the walnut of the stock and fore-end is obtained from a new technology that highlights the color contrast of the wood, resulting in a beautiful and rich pattern.

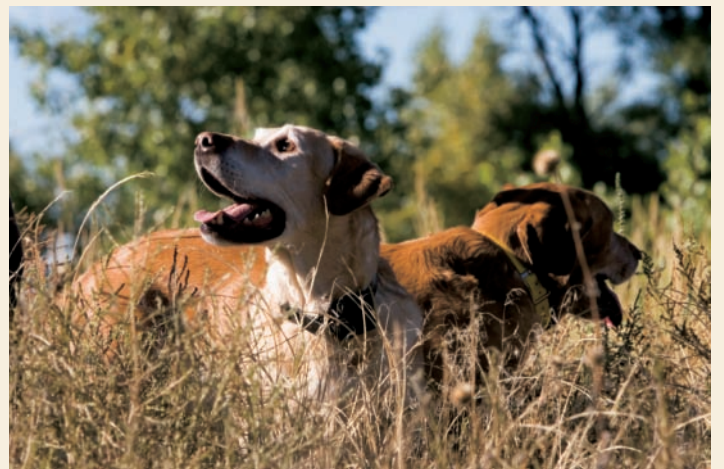



## APPAREL AND ACCESSORIES



**CORDURA**

### UPLAND CORDURA® JACKET

GU6B3570

SIZES M-XL/XXL-XXXL

Constructed of abrasion-resistant, high-performance Cordura, this bi-swing back jacket features ambidextrous recoil pockets, easy-clean no-seam game bag, easy-access full shell box pockets, non-skid shoulder gun rests, and too many other features to list.



**CORDURA**

### HEAVYWEIGHT HIGH-ABRASION

### UPLAND CORDURA® FIELD PANT

CU753570

SIZES 32-44

Field features include articulated knees, zip-open overboot side construction, rubberized waistband, hidden snap flaps and sideseam security pockets. Mesh-lined at the top for comfort.





# APPAREL AND ACCESSORIES

## UPLAND CORDURA® BLAZE CAP

BC139168

Traditional cap is constructed of water-repellent Cordura nylon with a waxed cotton brim to protect you in all kinds of weather.



**CORDURA**



## CORDURA® STRAP VEST

**CORDURA**

JG299V

SIZES I(M/L)/II(XL/XXXL)

Constructed of tough Cordura, this vest is durable. Blood-proof Teflon®-coated nylon-lined game bag.

## EASY-ENTRY FRONT-LOADING SHOOTING SHIRT

LONG SLEEVE LU227697 SIZES M-XL/XXL-XXXL

SHORT SLEEVE LU237697 SIZES M-XL/XXL-XXXL

The lined pocket extends all the way around to the back of the shirt. 100% cotton shirt has a vented cape back, roll-tab sleeves, Cordura shooting patch and forearm guards, and two shell openings above the bellows pocket.

*“There are two things I’ve always wanted in a bird hunting vest: light weight and durability. Even with a couple of birds in it, I hardly know I’m wearing this vest and it lets me stay cool. Most impressive of all, it shrugs off even the nastiest of briars.”*

George Cooper — President and CEO  
Theodore Roosevelt Conservation Partnership

## HARD CANVAS CASE

SVPD204 O/U OR S/S TO 32½"

SVPD208 O/U OR S/S 2 BBL TO 32"

Our hard canvas cases are built on the same high-quality frames as our leather cases for long-term durability and secure gun protection. The handsome 22-oz. canvas covering is finished with full-grain leather corner protectors and combo locks. USA canvas constructed in Mexico. (Gun will not fit in case with extended chokes attached.)





## APPAREL AND ACCESSORIES

### WAXWEAR FIELD GEAR

Keep your gear dry and organized even in the worst weather. The field-proven, military spec fabric is tear-resistant, dry to the touch, and waterproof. Unlike traditional oil-finished cottons, Waxwear has no oily finish or smell — only all the features needed to meet the demands of the upland hunter and waterfowler.

No Odor — Dry Hand  
**BERETTA WAXWEAR**  
The Preferred Performance Fabric  
*No Oil Migration!*

### GUN CASE PROTECTS WITH WRAPAROUND FOLDER CLOSURE

#### SFOUI0090

Our 54" gun boy case features a wraparound folder that will protect your shotgun from the elements. Comfortable non-skid shoulder strap and hand carry. Leather accents.

Colors: 87)spice, 76)loden.



### FIELD BAG — FLOATS

#### SBSUI0090

This durable bag will float fully loaded with six boxes of shells. Newly designed to give you more pockets, inside and out, including a new padded pistol sleeve behind the choke tubes. All brass hardware and top-quality leather trim. Comfort-curved, anti-slip shoulder strap. 17" x 11" x 12". Colors: 87)spice, 76)loden.

### WATERPROOF TRIPLE GAME BELT

#### SCAU00

Our rugged, waterproof Waxwear cotton game belt carries everything you need for a day in the field in three big pouches: two for shells and one lined for your birds. Sturdy leather belt adjusts to fit 32"-60" waists and wears comfortably fully loaded. Colors: 87)spice, 76)loden.



APPAREL AND ACCESSORIES



**WAXWEAR FIELD JACKET**

**GU422503** Sizes M-XLXXL

Classic hunt outerwear taken to a new performance and comfort level. Take to the field in confidence no matter which way the weather turns with a tear-resistant Waxwear shell and Thermore® insulation barrier between shell and full lining.

**WAXWEAR FIELD VEST**

**GU372503** Sizes M-XL/XXL

The vest has all features of the jacket, minus the sleeves! Hand-wash cold. Line dry. Do not iron or dry clean.

**WAXWEAR FIELD PARKA**

**GU46H2503** Sizes M-XLXXL

An ideal layering piece in wet weather. Vented cape back, attached hood, adjustable wind cuffs and drainage grommets help keep you dry and comfortable.



**WAXWEAR FIELD CHAPS**

**CU342503**

Sizes I (S/M)/II (L-up)

Constructed of 10-oz. cotton canvas, overlaid with Waxwear. Available in two leg-width sizes, I (S/M) and II (L and up). Snaps regulate the length.





APPAREL AND ACCESSORIES

NEW COMFORT MAPPING TECHNOLOGY

Breathability, comfort, warmth and fit — precisely where you need them most. This is what happens when the engineers at GORE-TEX® and Beretta put their heads together. Comfort Mapping Technology strategically uses different GORE-TEX® fabrics in specific locations for the ultimate in performance and comfort. Best of all, this breakthrough technology is constructed in a lightweight, breathable fabric that's easy to layer and easy to pack and carry.



**CORDURA**

COMFORT MAPPING JACKET

GU1E3152      Sizes M-XL/XXL

Innovative Comfort Mapping Technology transforms this coat into the best performing hunting jacket you've ever worn in the field. Cordura®, GORE-TEX® and PaLite, along with heat-formed seams, deliver a waterproof, warm and breathable outer shell that can take on the most extreme conditions.



APPAREL AND ACCESSORIES



**QUILTED MICROFIBER GAMEKEEPER'S JACKET & VEST**

**GU562505 Jacket**

Sizes M-XL/XXL

**GU5922505 Vest**

Sizes M-XL/XXL

Polyfill ensures warmth, while a ribbed knit neck helps keep cold breezes out. Color-coordinated suede leather trim on the pockets matches the two large recoil patches. Rib knit side panels and snap side vents for range of movement; two large shell pockets and two carry gun pockets. Jacket features removable Beretta braces and ribbed internal cuffs. Fully lined.



**BERETTA CLASSIC SHIRT**

**LU777676**

Sizes M-XL/XXL

Classic plaids in an easy wash-and-wear finish. The secret is in the weave and finishing of the pure cotton flannel yarn-dyed twill. Single-button patch pocket styling and center box pleat for easy movement.





INTRODUCING  
AMERICAN WATERFOWLER

Opening day. A time-honored tradition mixed with today's technology and innovation. The feel of your favorite camo jacket brings back memories of satisfying hunts past. Your waders still wear last year's mud as a badge of honor. As you ready for the day, you gather shells, decoys, hot coffee — and your shotgun. Then crouch in a blind with your dog expectant and eager. The thunder of wings above. The hope of the day ahead. Then that one heart-stopping, defining moment: the shot, the splash, the retrieve.

These are the slices of time that stir the soul, that define the American Waterfowler's passion for the pursuit of the wild places. It is a passion backed by the confidence that your Beretta shotgun and gear are absolutely up to this specific challenge—no matter what the elements throw at you. That's a confidence, backed by 500 years of tradition and technological innovation, you can count on with every pull of the trigger or zip of the jacket.

# AMERICAN WATERFOWLER



## XTREMA2



### KICK-OFF

Optional Kick-Off hydraulic dampening reduction system reduces recoil dramatically.



SYNTHETIC



AP CAMO



MAX-4 HD CAMO



Whether you are hunting the marshes or the wide open fields, there's a finish to handle the situation. The synthetic stock in black, Max-4 HD Camo, or AP Camo stands up to the elements.



UNTREATED



TREATED

## AQUA

Using accelerated salt spray testing, the unprotected steel barrel section (top) shows corrosive effects while the Aqua-technology protected barrel (bottom) looks brand new.



### XTREMA2 MOLDED CASE

Fitted, lined polypropylene case keeps the many supplied accessories in place. Includes 5 choke tubes, choke tube wrench, sling swivels, Beretta oil and butt plate or recoil pad.

*“Soft shooting, heavy-duty, reliable, and amazingly easy to clean. The Xtrema2 represents quite possibly the final word in 3½-inch semi autos.”*

—Phil Bourjaily, *Field & Stream Magazine*

# AMERICAN WATERFOWLER

WHEN WE DESIGNED A GUN FOR THE MOST EXTREME ENVIRONMENTS,  
WE WERE SURE TO WIN SOME EXTREME AWARDS.



## ***Xtrema2***

### XTREMA2 J391C28

In 2002, Beretta introduced the original Xtrema. This gun quickly garnered *Field & Stream*'s "Best Gun of the Year Award," *Guns & Ammo*'s "Editor's Awards for Gun of the Year," and *American Rifleman*'s "Golden Bulleye Award." In the relentless pursuit of excellence, our engineers have once again set the benchmark for a "do-it-all" shotgun in the form of the new Xtrema2—*Shooting Illustrated*'s "Shotgun of the Year."

This superb autoloading shotgun was designed and built to reliably function 2<sup>3</sup>/<sub>4</sub>-inch, 1-ounce equivalent loads through brutal 3<sup>1</sup>/<sub>2</sub>-inch magnum loads—interchangeably if you so desire. The Xtrema2 has more recoil reduction features than any other autoloading shotgun on the planet!



STANDARD GEL-TEK

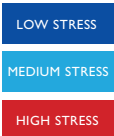

### STRESS CONCENTRATION IMAGING

This shows the behavior of the Gel-Tek pad during the shooting cycle. Note the homogenous distribution of stress over the entire surface.

### WHY BERETTA GAS OPERATED VS. INERTIA

Beretta's unique self-compensating semiautomatic gas operation system is considered the best in the world. The soft shooting gas system's recoil reduction, which automatically vents the excess gases of even the most powerful cartridges, simply can't be matched by inertia operated shotguns, which generally transfer the full recoil signature to the shooter. It is completely self-contained with no loose springs or o-rings to lose while field-stripping.

### RECOIL REDUCTION

Beretta's new Kick-Off hydraulic dampening reduction system reduces recoil an astounding 44% more than its closest rival by using two hydraulic recoil dampers incorporated into the stock "spacer" unit. The recoil energy is gradually dissipated by the hydraulic dampers, resulting in superior comfort for the shooter.

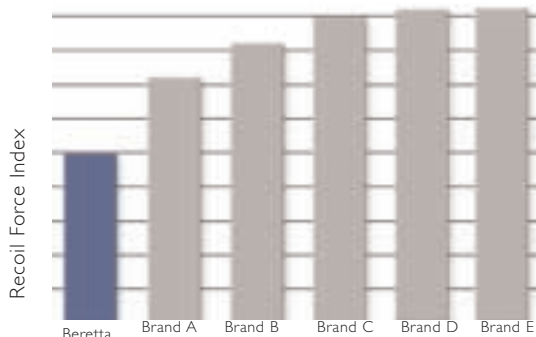

**Comparison Test of Recoil Force of Xtrema2 with Kick-Off vs. Major Competitors**

### XTREMA2

<b>ACTION</b>	SEMI-AUTOMATIC GAS OPERATION WITH TWO-LUG ROTATING BOLT AND SELF-COMPENSATING GAS VALVE
<b>GAUGE</b>	12
<b>CHAMBER</b>	3 <sup>1</sup> / <sub>2</sub> "
<b>BARREL LENGTH</b>	26", 28"
<b>STOCK/FORE-END</b>	SYNTHETIC WITH RUBBER INLAYS
<b>STOCK DROP - COMB</b>	1.34"
<b>STOCK DROP - HEEL</b>	2.36"
<b>LENGTH OF PULL</b>	(NON KICK-OFF MODEL) 13 <sup>1</sup> / <sub>4</sub> " TO 14 <sup>3</sup> / <sub>4</sub> " (KICK-OFF MODEL) 14 <sup>1</sup> / <sub>4</sub> "
<b>BUTT PLATE</b>	GEL-TEK
<b>SAFETY</b>	CROSS-BOLT
<b>TRIGGER</b>	BLACK
<b>FORE-END</b>	ROUND
<b>RIB TYPE</b>	FLAT 1/4" X 1/4"
<b>SIGHT</b>	METAL FRONT BEAD
<b>WEIGHT</b>	7.8 LBS
<b>CARRY CASE</b>	YES

# AMERICAN WATERFOWLER



## URIKA 2



### AL391 URIKA 2 CAMO AP® J39TVI6

Dressed in camo that disappears in nearly every setting, the AL391 Urika2 All Purpose® is a foil for the gobbler's keen eyesight. This reliable autoloader is a real workhorse, too. Beretta's self-compensating gas system allows for smooth shooting in a wide range of loads, while the Optima-Bore® system reduces recoil and improves pattern performance by easing the shot charge's passage down the bore.



### AL391 URIKA 2 CAMO MAX-4® J39TUI8

A smooth shooting, long-lasting auto shotgun, the AL391 Urika MAX-4® HD features the most effective and up-to-date camo pattern on the market — no matter which flyway you shoot on. Beretta's well-proven, self-compensating gas system provides just the right pressure for a wide range of loads, while the Optima-Bore® overbored barrel cuts recoil and improves your patterns.



### AL391 URIKA 2 SYNTHETIC J39TTI8

For the waterfowler who enjoys his shotgun in basic black and prefers the durability and versatility of a synthetic stock, this sleek autoloading shotgun is the answer. The hammer-forged barrel is chrome lined for corrosion resistance and easy cleaning, while Beretta's self-compensating gas valve lets you shoot the full range of your favorite ammunition.

#### AL391 URIKA 2 CAMO AP®

#### AL391 URIKA 2 CAMO MAX-4®

#### AL391 URIKA 2 SYNTHETIC

	SEMI-AUTOMATIC GAS OPERATION WITH SELF-COMPENSATING EXHAUST VALVE		
<b>ACTION</b>			
<b>GAUGE</b>	12	12	12
<b>CHAMBER</b>	3"	3"	3"
<b>BARREL LENGTH</b>	26"	28"	26"; 28"
<b>CHOKES</b>	OPTIMACHOKE® PLUS	OPTIMACHOKE® PLUS	OPTIMACHOKE® PLUS
<b>STOCK/FORE-END</b>	SYNTHETIC CAMO WITH RUBBER INSERTS	SYNTHETIC CAMO WITH RUBBER INSERTS	SYNTHETIC WITH RUBBER INSERTS
<b>STOCK DROP - COMB</b>	1.34"		
<b>STOCK DROP - HEEL</b>	TO 2.36"		
<b>BUTT PLATE</b>	GEL-TEK		
<b>SAFETY</b>	CROSS-BOLT, REVERSIBLE FOR LEFT-HANDED SHOOTERS		
<b>TRIGGER</b>	BLACK		
<b>FORE-END</b>	STANDARD		
<b>RIB TYPE</b>	FLAT ¼" X ¼"		
<b>SIGHT</b>	METAL FRONT BEAD		
<b>WEIGHT</b>	7.2 LBS (WITH KICK OFF 7.4 LBS)		
<b>CARRY CASE</b>	YES		

3901 SERIES

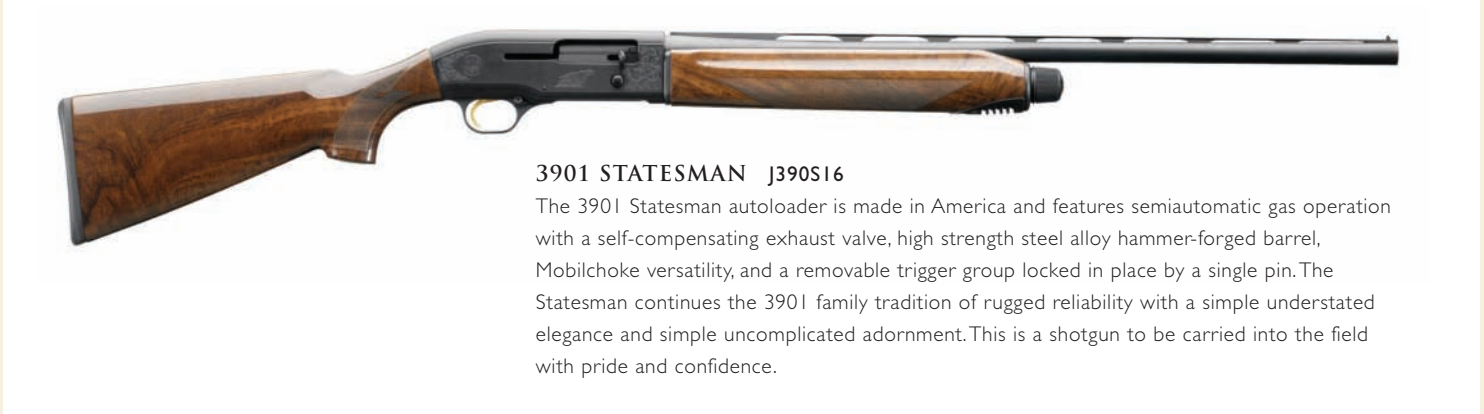

**3901 STATESMAN J390S16**

The 3901 Statesman autoloader is made in America and features semiautomatic gas operation with a self-compensating exhaust valve, high strength steel alloy hammer-forged barrel, Mobilchoke versatility, and a removable trigger group locked in place by a single pin. The Statesman continues the 3901 family tradition of rugged reliability with a simple understated elegance and simple uncomplicated adornment. This is a shotgun to be carried into the field with pride and confidence.



A blued bolt and carrier provide a classic look. Tasteful engravings also lend to the understated elegance.

*“Our shotguns worked fantastically on our recent trip to Argentina. Between the two of us, Frank and I shot 10,725 rounds of ammo through our new Beretta 3901 autoloaders. With the high volume of shooting like this, the low recoil and fast cycle time gave us great shots time after time.”*

— Pete Brownell, Vice President, Brownell’s —  
World’s largest supplier of firearms accessories and gunsmithing tools.™

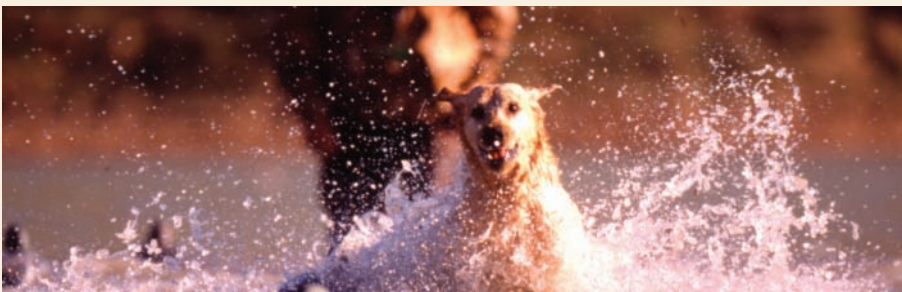

Beretta's self-compensating gas system diverts gas out the vent to provide just the right pressure to cycle the gun.

**3901 CITIZEN**

**3901 STATESMAN**

	3901 CITIZEN	3901 STATESMAN
<b>ACTION</b>	SEMI-AUTOMATIC GAS OPERATION WITH SELF-COMPENSATING EXHAUST VALVE	
<b>GAUGE</b>	12, 20	
<b>CHAMBER</b>	3"	
<b>WOOD FINISH</b>		SEMIGLOSS
<b>STOCK/FORE-END</b>	SYNTHETIC	WALNUT
<b>STOCK DROP – COMB</b>	1.34"	
<b>STOCK DROP – HEEL</b>	2.36"	
<b>BUTT PLATE</b>	RUBBER	RUBBER
<b>SAFETY</b>	CROSS-BOLT, REVERSIBLE FOR LEFT-HANDED SHOOTERS	
<b>RIB TYPE</b>	FLAT 1/4" X 1/4"	
<b>SIGHT</b>	STEEL BEAD	STEEL BEAD
<b>WEIGHT</b>	7.19 LBS (12 GAUGE); 6.55 LBS (20 GAUGE)	

WEIGHTS ARE APPROXIMATE, DEPENDENT ON WOOD DENSITY AND BARREL LENGTH.



APPAREL AND ACCESSORIES



**XTREMA GEAR CAMO WADER JACKET & PARKA**

**GU8D3160**      PARKA      SIZES M-XL/XXL  
**GU8E3160**      JACKET      SIZES M-XL/XXXL

With a particularly quiet fabric and a GORE-TEX® shell, our parka (full coverage) and wader jacket (shorter length to go in the water) were designed specifically to meet the outerwear performance demands of waterfowlers. Features include waterproof zippers and pockets, non-skid shoulder gun rests, a drawstring waist, magnetic pocket flaps, detachable hood, and reinforced pockets big enough to hold a full box of shells.



**XTREMA GEAR GLOVES**

**GL343160**      SIZES S-XXL

Adjustable-fit performance gloves, windproof, waterproof and warm thanks to GORE-TEX®, Windstopper® and thermore linings. Beretta's exclusive non-slip gripping surface.



**XTREMA GEAR DECOY GLOVES**

**GL323160**      SIZES S-XXL

Our insulated GORE-TEX® gloves are extra long in the wrist to keep your hands from getting wet when setting decoys.



APPAREL AND ACCESSORIES



**XTREMA GEAR BIBS**

**CO833160 SIZES M-XXXL**

Lightweight Thermore insulation maintains your body temperature; waterproof zippers and drainage grommets help keep you dry. Adjustable heavy-duty shoulder straps, upper handwarmer pockets, 18" overboot cover flange, and high-back kidney warmers.



**MAX 4 HAT**

**BE633160**

**ONE SIZE FITS MOST**

Complete your camo package with this waterproof GORE-TEX® fleece-lined hat. Drop-down ear flaps, adjustable locking cord.

**XTREMA GEAR PANTS**

**CU85360 SIZES M-XXXL**

GORE-TEX® guarantees to keep you dry; Beretta's experience provides all the features you need: waterproof zippers, drainage grommets, high-rise kidney warmer, heavy-duty belt loops, stride-ease knee, and zippered boot entry.

# AMERICAN WATERFOWLER

## APPAREL AND ACCESSORIES

### WATERPROOF XTREMA GEAR

Xtrema Gear is Beretta's collection of bags designed especially for waterfowl hunting. Built to take what nature dishes up, the bags are sealed on the outside to keep the insides dry. The brushed, 800-denier polyester fabric is coated with polyurethane and RF welded together to be tough, quiet, and waterproof. And they even float — what more could you want?



### XTREMA GEAR FIELD BAG

JA153A

The bottom snaps together in the middle to reduce the bulk and size. Exterior pockets for game calls, shells, maps, and personal extras. Water and dust-proof zippers. 6" x 14" x 12".



### XTREMA GEAR BLIND BAG

JA152A

Insulated thermos or water bottle pocket with drain, map pocket, shell and choke sleeves, exterior and interior pockets for cleaning or personal items. Anti-slip padded shoulder strap and easy-carry removable handle. 9" x 15" x 12". Water and dust-proof zippers.



### XTREMA GEAR GAME BAG

JA154A

A unique sealed inner bag, in combination with a fully sealed outer bag. Inner bag removes easily for cleaning. Easy to carry either over the shoulder or in the hand. 12" x 13" x 17". Water and dust-proof zippers.



### XTREMA GEAR STORMPROOF CAMO SHOTGUN CASE

JA150A

Padded grip handles make it easy to carry in the hand or over the shoulder. Every zipper is sealed, not sewn, with a stormproof urethane coating. Simply hose down to clean. Protects up to 54". Water and dust-proof zippers.



APPAREL AND ACCESSORIES



LONG SLEEVE MOCK TURTLENECK

P2007101

SIZES S-XL/XXL-XXXL

Ideal under any Beretta outerwear, our pre-washed 100% cotton turtleneck is as comfortable as it gets. Beretta logo embroidered on the collar.



WIND BARRIER SHORT AND LONG ZIP SWEATERS

PU337019 LONG ZIP

SIZES M-XL/XXL-XXXL

PU347019 SHORT ZIP

SIZES M-XL/XXL-XXXL

You'll find pure wool for warmth and rugged good looks on the outside of this sweater. But inside lies the secret: a barrier lining that keeps the coldest winds at bay. Fleece-lined collar; cotton twill gun patches, ribbed knit cuffs and bottom.





INTRODUCING  
AMERICAN BIG GAME HUNTER

Since the very first day you took to the mountains or the plains to test yourself against the cunning of the world's most sought after game, you've waited for this very instant. Both you and your prey are frozen in time. You've tracked this trophy, not just for hours or days, but since the very first time your father or your grandfather initiated you into the brotherhood of the hunt. With the prize squarely in your scope, you squeeze and put your faith in the hands of your rifle.

For the Big Game Hunter, nothing is more important than accuracy and reliability. No one understands that better than Beretta. Every rifle leaving the factory must be capable of grouping within one inch at a hundred yards—period. Sako and Tikka rifles are not just a benchmark in the industry, they have proudly helped define hunting tradition. Along with Big Game Hunting apparel and accessories, tested time and again by professional guides and hunters, these are the tools that define your heritage.

AMERICAN  
BIG GAME  
HUNTER

SAKO 85 HUNTER



SAKO 85 HUNTER JRS1A12

The Sako 85, a celebration of the rifle maker's 85th anniversary, is a superbly executed medley of tradition, technology and precision. Continuing Sako's time-honored tradition of crafting exceptional rifles for the hunter and target shooter, the Sako 85 incorporates the features most sought after by experienced riflemen: controlled-round feeding, an exceedingly fast lock time, a user adjustable trigger, 70-degree bolt handle lift with a silky smooth bolt travel, and broad flat bedding surfaces. The rifle's stock is crafted from select walnut and features the classic straight comb and shadow-line cheekpiece that premium-rifle owners appreciate. Individually factory tested and guaranteed to shoot five-shot groups of 1 MOA or less out of the box.



Classic straight comb with shadow-line cheekpiece.

SAKO 85 HUNTER,  
CONTROLLED ROUND FEED

<b>ACTION</b>	3-LUG BOLT ACTION
<b>CALIBER</b>	13 CALIBERS, SEE SAKO RIFLES CHART
<b>STOCK</b>	SELECT WALNUT, OIL FINISH
<b>FINISH</b>	BLUED
<b>RECOIL PAD</b>	RUBBER, BLACK
<b>SAFETY</b>	TWO-POSITION SAFETY WITH SEPARATE BOLT-RELEASE BUTTON
<b>TRIGGER</b>	SINGLE-STAGE, ADJUSTABLE
<b>MAGAZINE</b>	DETACHABLE, 5-ROUND CAPACITY, 4 W/WSM
<b>SIGHTS</b>	INTEGRAL TAPERED SCOPEMOUNT DOVETAILS



The new, patented, Total Control Magazine Latch prevents accidental release of the detachable stainless steel magazine under the heaviest recoil or the harshest of hunting conditions. If desired, the magazine may be reloaded without being removed from the rifle.



# WORLD'S FINEST PRODUCTION RIFLE

AMERICAN  
BIG GAME  
HUNTER



# sako

Sako rifles are regarded the world over as the most accurate rifles available out-of-the-box, offering custom rifle performance at production prices. Beretta is proud to call this brand a prominent part of its family.



The Sako 85 Short Claw Extractor commands total control of the cartridge, engaging the extractor groove of the cartridge as the cartridge rises from the magazine, positively guiding the cartridge into the chamber of the rifle. When single-round feeding, most controlled-round feed rifles require the cartridge to first be placed into the magazine. Not so with the Sako 85. The cartridge may be inserted directly into the chamber of the rifle and the bolt closes without any worry of damage to the extractor claw or cartridge rim.



The lengthened rear bolt guide makes an already smooth action even smoother. Typically, the shorter the action the more susceptible it is to bolt bind due to decreased bearing surface area. The lengthened rear bolt guide surface of the Sako 85 ensures the smoothest possible bind-free bolt travel, even in the very popular WSM chamberings.

## PRECISION AND SPEED EQUALS ACCURACY

The Sako 85 offers the shooter a crisp, single-stage trigger; user adjustable between 2.2 to 4.9 pounds, and an incredibly fast total lock time of under 1.3 milliseconds.



The bedding of the receiver is critical to the accuracy of any rifle. The flat bottom and side profiles of the Sako 85 receiver in conjunction with the innovative recoil lug, integral to the stock, allow stockmakers to mate the receiver to the stock with a degree of precision which is far more difficult to achieve with round profiled receivers and conventional recoil lugs. These flat surfaces also reduce the torque twist of the receiver against the stock bedding surfaces that occurs when a rifle is fired, prolonging the accuracy of the bedding.

AMERICAN  
BIG GAME  
HUNTER



## SAKO 85 FINNLIGHT



### SAKO 85 FINNLIGHT JRSIQ15

When weather is at its worst, determined hunters know there's no substitute for the combination of a stainless steel barreled action and a synthetic stock. No matter how long a downpour drenches these rifles, they'll be ready. Available in .13 calibers ranging from 243 to .300 Win Mag, in four action lengths, there's a Finnlight for almost any game, anywhere, anytime. As with all of our stainless rifles, the Finnlight's inner parts are also stainless.



SAKO REQUIRES  
THAT EVERY  
RIFLE MUST  
FIRE A 1-INCH,  
5-SHOT GROUP  
FROM 100  
YARDS, PRIOR  
TO LEAVING  
THE FACTORY.



Every Sako barrel is cold-hammer-forged and finished in-house to ensure match-grade accuracy. The muzzle crown is carefully cut by hand and final inspection is done using the most complex and highly refined optical fine tuning instrument known to man: the human eye.

### SAKO 85 SYNTHETIC EXCLUSIVES

Synthetic-stocked rifles frequently weigh less than their wood counterparts and, therefore, recoil slightly more. The innovative FinSoft recoil pad system absorbs and dissipates recoil forces away from the cheek, in more than one direction. Left-handed shooters can convert the stock with an accessory cheekpiece (not included).



### SAKO 85 FINNLIGHT

<b>ACTION</b>	3 LUG BOLT ACTION, CONTROLLED ROUND FEED
<b>CALIBER</b>	10 CALIBERS, SEE SAKO RIFLES CHART
<b>STOCK</b>	SYNTHETIC W/OVERMOLDED GRIPS, BLACK
<b>FINISH</b>	STAINLESS STEEL
<b>RECOIL PAD</b>	FINSOFT, BLACK
<b>SAFETY</b>	TWO-POSITION SAFETY WITH SEPARATE BOLT-RELEASE BUTTON
<b>TRIGGER</b>	SINGLE-STAGE, ADJUSTABLE
<b>MAGAZINE</b>	DETACHABLE, 5-ROUND CAPACITY, 4 W/WSM
<b>SIGHTS</b>	INTEGRAL TAPERED SCOPEMOUNT DOVETAILS





AMERICAN  
BIG GAME  
HUNTER

## SAKO 85 GREY WOLF & VARMINT SERIES



### SAKO 85 GREY WOLF JRS2C18

A natural-born hunter, the Sako 85 Grey Wolf features the same all-stainless barreled action as its cousin, the Sako 85 Finnlight, combined with an attractive, natural-feel, ultra-tough checkered grey laminated stock. The stainless barreled action and warp-free stock make this rifle perfect for hunting in extreme conditions while retaining the traditional warm look and feel of the wood stock.

### SAKO 85 GREY WOLF

<b>ACTION</b>	3 LUG BOLT ACTION, CONTROLLED ROUND FEED
<b>CALIBER</b>	11 CALIBERS, SEE SAKO RIFLES CHART
<b>STOCK</b>	LAMINATED HARDWOOD, MATTE GREY/BLACK
<b>FINISH</b>	STAINLESS STEEL
<b>RECOIL PAD</b>	RUBBER, BLACK
<b>SAFETY</b>	TWO-POSITION SAFETY WITH SEPARATE BOLT-RELEASE BUTTON
<b>TRIGGER</b>	SINGLE-STAGE, ADJUSTABLE
<b>MAGAZINE</b>	DETACHABLE, 5-ROUND CAPACITY, 4 W/WSM
<b>SIGHTS</b>	INTEGRAL TAPERED SCOPEMOUNT DOVETAILS



### SAKO 85 VARMINT

### SAKO 85 VARMINT LAMINATED STAINLESS

<b>ACTION</b>	85 SHORT	85 SHORT
<b>CALIBER</b>	5	5
<b>STOCK</b>	WOOD	LAMINATED BROWN
<b>FINISH</b>		STAINLESS STEEL
<b>RECOIL PAD</b>	RUBBER	RUBBER
<b>SAFETY</b>	TWO-POSITION SAFETY WITH SEPARATE BOLT-RELEASE BUTTON	
<b>TRIGGER</b>	SINGLE SET	
<b>MAGAZINE</b>	DETACHABLE, 5-ROUND CAPACITY	
<b>SIGHTS</b>	INTEGRAL TAPERED SCOPEMOUNT DOVETAILS	



### SAKO 85 VARMINT JRS1F15



### SAKO 85 VARMINT LAMINATED STAINLESS JRS1G12

Because our customers live the Beretta lifestyle so passionately, they are a rich source of information and feedback on our products. Customers suggested we offer a single set trigger as standard in our Varmint line, as well as the .204 Ruger caliber. We've done just that, updating our Varmint line to include a set trigger and the new calibers. The way this single set trigger works is simple. If used normally, it functions like a standard Sako trigger, adjustable for weight and pull from 2 to 4 pounds. But after you cock the bolt, you can push the trigger forward (instead of pulling it), thus "setting" it for an amazingly light 7.5-ounce pull, making it ideal for target and precision varmint shooting.

AMERICAN  
BIG GAME  
HUNTER

SAKO A7

WORLD-CLASS ACCURACY. GUARANTEED.



GIUGIARO  
D E S I G N

sako **A7**

TWO PIECE BOLT WITH FORGED STEEL BODY, THREE LOCKING LUGS AND SHORT SMOOTH 70 DEGREE BOLT LIFT.

TWO POSITION SAFETY WITH SEPARATE BOLT-RELEASE BUTTON.

SYNTHETIC STOCK WITH RUBBER RECOIL PAD AND SLING SWIVEL MOUNTS

FORGED STEEL ROUND-TOP RECEIVER DRILLED AND TAPPED FOR SCOPE MOUNT BASES (INCLUDED).

FULLY FREE-FLOATING MATCH-GRADE HAMMER FORGED BARREL



TOTAL CONTROL MAGAZINE LATCH.

DETACHABLE SYNTHETIC MAGAZINE WITH STEEL FEED LIPS.

CRISP SINGLE-STAGE TRIGGER ADJUSTABLE FROM 2-4 POUNDS



David and Kristin Morris proudly show off the first whitetail buck ever taken with the new Sako A7. This awesome 26-inch-wide buck, taken on *The Bucks of Tecomate* TV show on David's El Cazador Ranch in South Texas, grossed an amazing 190 B&C points and scored high enough to qualify for the Boone & Crockett Record Books as a typical 10-pointer. What a start to the great tradition sure to be established by the Sako A7!



# AMERICAN BIG GAME HUNTER



## SAKO A7 JRSY118

Any rifle can boast technology but in the end it all comes down to accuracy, and Sako rifles enjoy the reputation throughout the world as producing the most accurate production rifles on the planet.

Beretta's new Sako A7 represents the beginning of a new era for the American hunter, joining Sako's legendary Finnish tradition of accuracy and reliability with today's American hunter. With better out-of-the-box accuracy and reliability than any other rifle brand on the market, the new Sako A7 boasts match-grade performance with a price never before seen on a match-grade hunting rifle.



The Sako A7 2-piece bolt utilizes a bolt body machined from a solid piece of forged steel that is strong and reliable while offering a silky-smooth action.



Every Sako barrel is cold-hammer forged and finished in-house to ensure match-grade accuracy. The muzzle crown is carefully cut by hand to maximize match-grade performance.



Known for refined and modern design, the A7 features a sleek, lightweight composite stock with a unique, textured "wave" pattern on the grip and fore end, providing for a sure grip in any weather.



The A7's single stage trigger system is not only crisp and precise but also is adjustable from 2 to 4 pounds of pull weight.



Machined from a solid steel forging, the Sako A7 has one of the strongest, most torsionally-rigid actions made. Available in two action lengths that are perfectly scaled to the available cartridges.

### SAKO A7

<b>ACTION</b>	A7 THREE LUG, SHORT BOLT LIFT ACTION. TWO LENGTHS SCALED TO AVAILABLE CARTRIDGES.
<b>CALIBER</b>	12 CALIBERS
<b>STOCK</b>	SYNTHETIC
<b>FINISH</b>	STAINLESS STEEL OR BLUED STEEL
<b>RECOIL PAD</b>	RUBBER
<b>SAFETY</b>	2 POSITION WITH BOLT LOCK RELEASE
<b>TRIGGER</b>	SINGLE STAGE
<b>MAGAZINE</b>	DETACHABLE 3+1 CAPACITY
<b>SIGHTS</b>	SCOPE MOUNT BASES, INCLUDED

AMERICAN  
BIG GAME  
HUNTER



SAKO TRG



SAKO TRG JRSM216

Sako TRG is a total accuracy concept designed for one job only: to hit the target. This spectacular result of 100% Sako innovation gives you performance that transcends the highest demands for accuracy, reliability and versatility. The TRG is designed to meet individual tasks, and adjusts to each shooter's personal style, build and posture. Super target grade barrels, specially made for TRG (Cr-Mo or stainless), are cold-hammer forged. The solid vault-like action is also hammer forged from special steel alloy. The sturdy bolt with three locking lugs feeds rounds unflinching from the centerline of a detachable staggered magazine. Bolt lift angle is only 60° for fast bolt throw. The target trigger is a fully adjustable two-stage unit. The integral 17mm axial rails with recoil stop-slots on the top of the receiver allow a quick and perfect scope mounting.



TRG-BIPOD

Especially designed for sniping, this new bipod lets the rifle "hang" below the hinge-point offering very steady shooting position even with large and heavy scopes on the rifle.



Tactical scope mount for modern three turret tactical scopes (30 and 34 mm tube diameter). The mount has 0.5 degree elevation allowance (30 MOA) for better adjustment range capability in long range shooting.



Now available  
in Desert Tan

BUTT STOCK

Adjustable for height and cast-off/on. Cheekpiece adjustable laterally and with spacers, also vertically. Specially designed contour allowing for steady and firm firing position.



The TRG22 is also available in a tactical folding stock.



# AMERICAN BIG GAME HUNTER



All Sako TRG receivers are drilled and tapped for tactical (Picatinny) rails compatible with USA MIL-STD 1913. Configurations include black or green high-tech aluminum reinforced composite fully adjustable stock (cheekpiece and buttplate). Also available in an all-black stealth configuration featuring black stock with phosphatized barrel and action. Optional TRG accessories include a highly effective 3-chamber muzzle brake, innovative clip-on bipod, extra magazines, auxiliary adjustable sights, mirage strap, scope mounts, Picatinny interface, sling and swivels, cleaning kit, logistic transportation case as well as spacers for cheekpiece and butt plate.

## SAKO TRG 42 JRSM131

The TRG 42 in .300 Win. Magnum and .388 Lapua Magnum is a superlative long-range precision tool already adopted by numerous military and law-enforcement special units worldwide and also eminently suitable for competition and ultra-long range varminting. The TRG 42 can be equipped with various accessories to fulfill the needs of the most demanding tactical shooter.



## SAKO TRG 22 JRSM316

The TRG 22 in .308 Win. incorporates all the technical attributes of the TRG 42 in a design scaled to the .308 cartridge. The TRG 22 is a thoroughbred International Sport Shooting Federation 300 Meter Standard Competition rifle, a CISM (International Military Sports Council) competition winner and is in service with several nations as their primary military and law enforcement tactical rifle.



Highly effective three-chamber muzzle brake.

### SAKO TRG 42

### SAKO TRG 22

<b>ACTION</b>	TRG 3-LUG BOLT ACTION	TRG 3-LUG BOLT ACTION
<b>CALIBER</b>	.300 WIN MAG, .338 LAPUA MAG	.308 WIN
<b>STOCK</b>	SYNTHETIC BLACK, DESERT TAN*, OR GREEN. FULLY ADJUSTABLE BUTT STOCK AND CHEEKPIECE	
<b>RECOIL PAD</b>	RUBBER, BLACK	
<b>SAFETY</b>	TWO-POSITION LOCKING TRIGGER, BOLT HANDLE AND FIRING PIN	
<b>TRIGGER</b>	DOUBLE STAGE TRIGGER, ADJUSTABLE	
<b>MAGAZINE</b>	DETACHABLE, 7 ROUNDS (.300 WIN MAG), 5 ROUNDS (.338 LAPUA MAG)	DETACHABLE, 10 ROUNDS
<b>SIGHTS</b>	NONE INCLUDED. INTEGRAL 17MM RAIL ACCOMMODATES OPTIONAL PICATINNY RAIL, QD OPTILOCK SCOPE MOUNTS AND AUXILIARY IRON SIGHT SYSTEMS.	
<b>WEIGHT</b>	11.25 LBS (BLACK AND TAN STOCK) 11.7 LBS (GREEN STOCK)	10.4 LBS (BLACK AND TAN STOCK) 10.8 LBS (GREEN STOCK)

\* DESERT TAN AVAILABLE IN .338 LAPUA AND .308 WIN ONLY.

# AMERICAN BIG GAME HUNTER



One rifle now allows you to own any or all of the four most popular rimfire cartridges available. Truly unique in the world of rimfire rifles, the Sako Quad lets you select any of the four interchangeable cold-hammer-forged rifled barrels and change them in seconds. The barrels may be removed and replaced without change in the point of impact. The Sako Quad features a supersmooth bolt throw with a short 50-degree bolt handle lift, detachable magazine, and user adjustable trigger system. Complete rifles and optional spare barrels chambered for .22 LR, .22 WMR, .17 HMR or .17 Mach2 are available.



## SAKO QUAD HUNTER JRSR4CI

The Sako Quad Hunter features an attractive oil-finished walnut stock that will please even the staunchest traditionalists. Sako craftsmen have created a new checkering pattern integrating a distinctive "shark-gill" with traditional cut checkering. The Quad Hunter features a detachable magazine, adjustable trigger, and minute-of-angle accuracy.

Each barrel and magazine is color coded for easy recognition. Just match the barrel band color with the correct dot color on the magazine. As an added feature, the magazines provide a unique safety system to prevent insertion with the wrong barrel in place.



## BURRIS SAKO QUAD 3-9X32MM SCOPE

Color-coded windage and elevation adjustments are matched to the color coding on the Sako Quad barrels. Once calibrated for each of the calibers, a barrel change requires only a turn of the corresponding dial to zero the scope to the appropriate barrel.



Barrels can be easily changed by using the Sako Quad barrel tool.

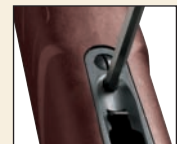

## SAKO QUAD HUNTER COMBO

## SAKO QUAD VARMINT HUNTER TWO BARREL COMBO

<b>ACTION</b>	BOLT ACTION
<b>CALIBER</b>	.22 LR, .22 WMR, .17 MACH2, .17 HMR .17 HMR/.22LR
<b>STOCK</b>	WALNUT
<b>FINISH</b>	BLUED
<b>RECOIL PAD</b>	RUBBER,
<b>SAFETY</b>	TWO-POSITION
<b>TRIGGER</b>	SINGLE STAGE TRIGGER, ADJUSTABLE
<b>MAGAZINE</b>	METAL DETACHABLE
<b>SIGHTS</b>	NONE



# SAKO RIFLES CHART

## AMERICAN BIG GAME HUNTER

MODEL	DIMENSIONS				CALIBER / RATE OF TWIST																SIGHTS			TRIGGER			MAGAZINE CAPACITY (ROUNDS)	MUZZLE THREAD	FOLDING STOCK	PHOSPHATIZED BARREL / RECEIV.							
	ACTION	TOTAL LENGTH (IN)	BARREL LENGTH (IN)	WEIGHT (LBS APPROX)	.17 MACH 2 9"	.17 HMR 9"	.22 LR 16.5"	.22 WMR 16"	.204 RUGER *	.223 REM *	.22 - 250 REM 14"	.243 WIN 10"	.260 REM 9"	.7MM - .08 REM 9.5"	.308 WIN 11"	.338 FEDERAL 10"	.270 WIN SHORT MAG 10"	.300 WIN SHORT MAG 11"	.25 - 06 REM 10"	.270 WIN 10"	.30 - 06 SPRG 11"	.338 WINI MAG 10"	.370 SAKO MAG 14"	.375 H & H 11"	.300 WIN MAG 14"	.338 LAPUA MAG 12"					METAL SIGHTS	WITHOUT SIGHTS	PICATINNY - RAIL	SINGLE - STAGE TRIGGER	DOUBLE - STAGE TRIGGER	SINGLE - SET TRIGGER	
<b>QUAD HUNTER</b>	P04R	39.8"	22.05"	5.9	●	●	●	●																									5				
<b>85 HUNTER</b>	S	42.3"	22.4"	7						●	●	●	●	●	●																	5					
	SM	44.3"	24.4"	7.3												●	●															4					
	M	42.7"	22.4"	7.3															●	●	●											5					
	L	44.3	24.4	7.3																		●	●	●	●												
<b>85 GREY WOLF</b>	S	42.9"	22.4"	7.3						●	●	●	●	●	●																5						
	SM	40.9"	24.4"	7.5												●	●														4						
	M	43.3"	24.4"	7.5															●	●	●	●									5						
<b>85 FINNLIGHT</b>	S	42.9"	24.4"	6.4						●	●	●	●	●																	5						
	SM	44.9"	24.4"	6.6												●	●														4						
	M	43.7"	22.8"	6.6															●	●	●										5						
<b>85 VARMINT</b>	XS	43.1"	23.6"	8.1				●	●																						●	4					
	S	43.5"	23.6"	8.6						●	●		●																		●	5					
<b>85 VARMINT LAMINATED STAINLESS</b>	XS	43.1"	23.6"	8.6				●	●																						●	4					
	S	43.5"	23.6"	9						●	●		●																		●	4					
<b>TRG-22 BLACK</b>	TRG	45.3"	26"	4.7										●																		10	●				
<b>TRG-22 GREEN</b>	TRG	45.3"	26"	4.9										●																		10	●	●	●		
<b>TRG-22 DESERT TAN</b>	TRG	45.3"	26"	4.9										●																		10	●		●		
<b>TRG-42 BLACK</b>	TRG	47.2"	27"	11.2																					●							7	●				
<b>TRG-42 BLACK</b>	TRG	47.2"	27"	11.2																					●							5	●				
<b>TRG-42 GREEN</b>	TRG	47.2"	27"	11.7																					●							7	●		●		
<b>TRG-42 GREEN</b>	TRG	47.2"	27"	11.7																					●							5	●		●		
<b>TRG-22 DESERT TAN</b>	TRG	47.2"	27"	11.7																					●							5	●		●		
<b>SAKO A7</b>	S	42.3	22.4	6.4						●	●		●	●		●	●	●	●	●					●							3					
	M	42.8	22.4	6.4						●	●		●	●		●	●	●	●	●					●								3				
<b>SAKO A7 STAINLESS</b>	S	42.3	22.4	6.4						●	●		●	●		●	●	●	●	●					●								3				
	M	42.8	22.4	6.4						●	●		●	●		●	●	●	●	●					●								3				

RIFLE WEIGHT MAY VARY DEPENDING ON WOOD DENSITY AND CALIBER. THE MANUFACTURER RESERVES THE RIGHT TO MODIFY SPECIFICATIONS.

AMERICAN  
BIG GAME  
HUNTER

TIKKA T3 SERIES



TIKKA T3 HUNTER JRTA312

The Tikka T3 Hunter features a glass-smooth action, a crisp, adjustable trigger, free floated match-grade hammer-forged barrel and a perfect mating between stock and metal. No Tikka T3 is even put on the shipping dock unless it groups 3 shots within 1 inch or less at 100 yards. Besides this fabulous performance, the T3 Hunter features a blend of Giugiaro distinctive checkering with the classic elegance of wood. **Left-hand models available see index.**



TIKKA T3 LITE STAINLESS JRTB312

Synthetic stocks are the choice of hunters who must face tough weather conditions. With its stainless steel finish, the Tikka T3 Lite Stainless offers even better resistance to the elements. The lightweight, injection-molded stock is a godsend to hunters who spend long days in the mountains, as is its guaranteed accuracy. With a Giugiaro-designed stock, this rifle's harmonious and functional layout is both handsome and fast handling. **Left-hand models available see index.**

TIKKA T3 HUNTER

TIKKA T3 LITE STAINLESS

	TIKKA T3 HUNTER	TIKKA T3 LITE STAINLESS
<b>ACTION</b>		2-LUG BOLT ACTION, PLUNGER EJECTOR
<b>CALIBER</b>	15 CALIBERS, SEE TIKKA RIFLES CHART	RH 15 CALIBERS, LH 10 CALIBERS, SEE TIKKA RIFLES CHART
<b>STOCK</b>	WALNUT	SYNTHETIC
<b>FINISH</b>	BLUED	STAINLESS STEEL
<b>RECOIL PAD</b>		RUBBER, BLACK
<b>SAFETY</b>		TWO-POSITION
<b>TRIGGER</b>		SINGLE-STAGE, ADJUSTABLE
<b>MAGAZINE</b>		FLUSH, DETACHABLE SEE TIKKA RIFLES CHART
<b>SIGHTS</b>		WITHOUT





# AMERICAN BIG GAME HUNTER

## TIKKA T3 SERIES



**GIUGIARO**  
DESIGN



### TIKKA T3 LITE JRTE312

Inspired by the strengths of the mighty game animal, the Tikka T3 Lite is perfect for the hunter who chases his quarry in dense woods or from a tree stand, or for the rancher who likes to keep a versatile rifle handy. Just as accurate as its full-size brothers, this synthetic features a quick-handling 19-inch cold-hammer-forged and free-floated barrel. Durable fiberglass-reinforced polymer stock with a straight comb and ambidextrous palm-swell. **Left-hand models available see index.**

### TIKKA T3 LITE

<b>ACTION</b>	BOLT ACTION WITH TWO LOCKING LUGS, PLUNGER EJECTOR
<b>CALIBER</b>	14 CALIBERS, SEE FIREARMS INDEX
<b>STOCK</b>	SYNTHETIC
<b>FINISH</b>	BLUED
<b>RECOIL PAD</b>	RUBBER, BLACK
<b>SAFETY</b>	TWO-POSITION
<b>TRIGGER</b>	SINGLE-STAGE, ADJUSTABLE
<b>MAGAZINE</b>	FLUSH, DETACHABLE. SEE FIREARMS INDEX
<b>SIGHTS</b>	WITHOUT

A short bolt-lift angle of 70 degrees combined with a bolt throw to match the cartridge length means quick and smooth bolt cycling.



### TIKKA T3 VARMINT JRTH312

Serious varmint hunting and benchrest shooting require the hyper-accuracy of the Tikka T3 Varmint. The cold-hammer-forged barrel has a true varmint-style "bull" contour for maximum rigidity and absolute performance. The stable synthetic stock incorporates a high comb and wide forearm for better stability. As with all Tikka T3 rifles, the muzzle crown is concave and hand-turned — a custom feature that will enhance the performance of your rifle by protecting the lands and grooves from anything that may come into contact with the muzzle.

### TIKKA T3 VARMINT

<b>ACTION</b>	2-LUG BOLT ACTION, PLUNGER EJECTOR
<b>CALIBER</b>	3 CALIBERS, SEE FIREARMS INDEX
<b>STOCK</b>	SYNTHETIC WITH RAISED COMB / BEAVERTAIL
<b>FINISH</b>	BLUED
<b>RECOIL PAD</b>	RUBBER, BLACK
<b>SAFETY</b>	TWO-POSITION
<b>TRIGGER</b>	SINGLE-STAGE, ADJUSTABLE
<b>MAGAZINE</b>	EXTENDED, DETACHABLE. SEE TIKKA RIFLES CHART

The ridged Tikka receiver is topped off with integral rails for use with Optilock mounts. This action is also drilled and tapped for use with conventional bases.



# AMERICAN BIG GAME HUNTER

## TIKKA T3 TACTICAL



### TIKKA T3 TACTICAL JRTM12

When it comes to accuracy, the Tikka T3 Tactical is in a class of its own. The free-floating barrel is made of match grade Cr-Mo steel and manufactured by a precision cold-hammer forging process. The action and the barrel surfaces are manganese phosphatized for lasting protection against the elements and wear. The modern Teflon-coated bolt has two front locking lugs and springloaded plunger ejector with 70 degree opening angle for fast, smooth and reliable operation. The 2-way safety locks both the bolt and the trigger. The trigger unit is adjustable with hand-honed sear/trigger without creep. Single set trigger is optional.



The detachable straight-feeding single column magazine is silent, durable and non-rusting. The standard 5/6-round magazines are tailored for each caliber for ultimate reliability and performance. New color coded magazines optional make the use of different loads easy to separate.

The stock is made of fiberglass reinforced copolymer polypropylene. The cheek-piece is adjustable at 5mm interval up to 25mm. The adjusting wheel can be fitted on either side of the stock.



### ACCESSORIES

The standard Picatinny rail takes any Weaver or U.S. Mil. Std. 1913 compatible mounts. Scope, scope mounts, bipod, muzzle brake and heavy duty swivel studs are optional, as well as adjustable open sights and fore-and rear-stock fastened military type heavy duty sling studs for hook-type swivels.



### TIKKA T3 TACTICAL

<b>ACTION</b>	2-LUG BOLT ACTION, PLUNGER EJECTOR
<b>CALIBER</b>	2 CALIBERS, .223 REM, .308 WIN
<b>STOCK</b>	SYNTHETIC WITH ADJUSTABLE CHEEK-PIECE
<b>FINISH</b>	MAGANESE PHOSPHATE
<b>RECOIL PAD</b>	RUBBER, BLACK
<b>SAFETY</b>	TWO-POSITION, ADJUSTABLE
<b>MAGAZINE</b>	EXTENDED, DETACHABLE
<b>TRIGGER</b>	SINGLE-STAGE, ADJUSTABLE
<b>SIGHTS</b>	WITHOUT



# AMERICAN BIG GAME HUNTER

## TIKKA RIFLES CHART

MODEL	DIMENSIONS				CALIBERS													STOCK			TRIGGER			MAGAZINE CAPACITY (ROUNDS)		OPTIONAL MAGAZINE (ROUNDS)		ADJUSTABLE CHEEK PIECE		MUZZLE THREAD		LEFT HAND MODELS			
	T3 ACTION	TOTAL LENGTH (MM)	BARREL LENGTH (MM)	WEIGHT (KG APPROX.)	8"	14"	10"	9"	9.5"	11"	10"	10"	11"	9.5"	11"	10"	11"	10"	WALNUT	INJECTION MOULDED	WITHOUT SIGHTS	PICATINNY RAIL	SINGLE - STAGE TRIGGER	4	6	3	5	3	5	3	5	3	5		
<b>T3 HUNTER</b>	S	42.52"	22.44"	6.8	•														•	•	•	•	•	4	6										
	ME	42.52"	22.44"	6.8		•	•	•	•	•									•	•	•	•	•	3	5										•
	SM	44.49"	24.41"	6.2							•	•							•	•	•	•	•	3											•
	L	*	*	*										•	•	•			•	•	•	•	•	3											•
	M	*	*	*												•	•	•	•	•	•	•	•	3											•
<b>T3 LITE</b>	S	42.52"	22.44"	6.8	•														•	•	•	•	•	4	6										•
	ME	42.52"	22.44"	6.8		•	•	•	•	•	•								•	•	•	•	•	3	5										•
	SM	44.49"	24.41"	6.4							•	•							•	•	•	•	•	3											•
	L	42.52"	22.44"	6.8										•	•	•			•	•	•	•	•	3	5										•
	M	44.49"	24.41"	6.4											•	•	•		•	•	•	•	•	3	5										•
<b>T3 VARMINT</b>	S	43.7"	23.62"	7.9	•														•	•	•	•	•	6	4										
	ME	43.7"	23.62"	7.9		•	•	•	•	•									•	•	•	•	•	5	3										
<b>T3 TACTICAL</b>	S	40.16"	20.08"	7.9	•														•	•	•	•	•	6								•	•		
	S	43.7"	23.62"	8.1															•	•	•	•	•	6								•	•		
	ME	40.16"	20.08"	7.9															•	•	•	•	•	5								•	•		
	ME	43.7"	23.62"	8.1						•									•	•	•	•	•	5								•	•		
	M	43.7"	23.62"	8.1															•	•	•	•	•	5								•	•		

S = SHORT ME = MEDIUM SM = SHORT MAGNUM L = LONG M = MAGNUM • = STANDARD  
 RIFLE WEIGHT MAY VARY DEPENDING ON WOOD DENSITY AND CALIBER. THE MANUFACTURER RESERVES THE RIGHT TO MODIFY SPECIFICATIONS.  
 \* CONTACT YOUR LOCAL DEALER



AMERICAN  
BIG GAME  
HUNTER



## 3901 RIFLED SLUG SHOTGUN

In many areas of the world, the Rifled Slug Shotgun is the firearm of choice for non-dangerous big game hunting and there is no finer choice than the Beretta 3901 Rifled Slug shotgun, featuring a 24-inch barrel with a rifling profile optimized for superior accuracy with sabot-style slugs, chrome-lined chamber and bore for ease of cleaning and rust resistance. The integral cantilever Picatinny scope-mount rail ensures constant ridged alignment of the scope to the barrel for maximum accuracy and accepts common Weaver-style scope rings, such as Sako Optilock and Burris systems.



### 3901 RIFLED SLUG SHOTGUN J390C16

Designed for the American Big Game Hunter, the 3901 Rifled Slug Shotgun is a 12-gauge, gas-operated semiautomatic with a 3-inch chamber. Its ribless and sightless barrel features clean, snag-free lines, making it ideal for negotiating dense woods or the confines of a deer blind. Its heavier contour makes the barrel more rigid and the gun softer-recoiling. The stock is black, high-impact synthetic with traditional point-checkering patterns.

### 3901 RIFLED SLUG GUN

<b>ACTION</b>	SEMI-AUTOMATIC GAS OPERATION WITH SELF-COMPENSATING GAS VALVE
<b>GAUGE</b>	12
<b>CHAMBER</b>	3"
<b>BARREL</b>	24" RIFLED
<b>STOCK AND FORE-END</b>	SYNTHETIC
<b>STOCK DROP - COMB</b>	1.34"
<b>STOCK DROP - HEEL</b>	2.36"
<b>RECOIL PAD</b>	RUBBER
<b>SAFETY</b>	CROSS-BOLT, REVERSIBLE
<b>RIB TYPE</b>	NONE
<b>SIGHTS</b>	CANTILEVER PICATINNY RAIL, SCOPE AND RINGS NOT INCLUDED
<b>WEIGHT</b>	7.6 LBS
<b>CARRY CASE</b>	YES



APPAREL AND ACCESSORIES



Tested time and again by professional guides and hunters, Beretta's Big Game Hunter collection lets you take to the field in full confidence that you're equipped with the very best.

**DWS BIG GAME GORTEX PARKA**  
**GU6D2286**      Sizes M-XL/XXL-XXXL

Magnetic pocket flaps and hands-free backpack braces top a list of features that include a retractable bi-swing back, zip-off hood, non-skid shoulder gun rest, reinforced full shell-box pockets with drainage grommets, waterproof zippers, "perfect seal" cuffs and more. Available in RealTree AP Camo.



**BIG GAME INTERACTIVE**  
**SOFT SHELL JACKET**

**GU6E5057**      Sizes M-XL/XXL-XXXL

Slip this technical fleece over whatever you're wearing for instant warmth. Windstopper membrane makes it totally windproof, yet breathable. Soft jacket features non-skid shoulder rest, waterproof zippers, easy slide-entry sleeves and easy-access security pockets. Available in RealTree AP Camo.

**GORTEX BIG GAME**  
**HUNTING GLOVES**

**GL3I2286**      Sizes S-XXL

GORTEX® lining ensures waterproof breathability, while extended, adjustable cuffs keep the wind out. Available in RealTree AP Camo.



AMERICAN  
BIG GAME  
HUNTER



APPAREL AND ACCESSORIES



**WINDSTOPPER® CAMO MICROFLEECE COLLECTION**

Keep warm, comfortable and hidden from your prey across a wide range of weather conditions and terrains in this technical fleece gear. Windstopper membrane combines total windproofness with maximum breathability, allowing you to concentrate on the hunt. Full zip jacket features uni-control fleece neck lining, waterproof zippers, handwarmer pockets, back kidney warmer and underarm ventilation zippers. Coordinated fleece pants constructed with articulated knee, built-in waistband back support, and easy on/off boot zippers. Pants are lined in mesh in upper body with an elasticized waist and suspender buttons. Add fleece hat and gloves for complete weather and camo protection.

- Jacket GU6G5061 Sizes M-XL/XXL
- Pant CU825061 Sizes M-XL
- Cap BE625061 One size
- Gloves GL33506 Sizes M-XXL



**HUNTING PACK**

**JA230**

The large main compartment has organized pockets for both field gear and personal items, while the sophisticated mountaineering suspension lets you shoulder a heavy load with ease. This waterproof, 650-denier poly pack features a secure vertical rifle carrier, removable communications pocket, interior hydration bladder pocket, and a waistband that hides away for safe climbing to a treestand.



Each pack comes with a reversible blaze orange & Hardwoods camo rain cover.



**BIS PACKABLE JACKET & VEST**

- GUIM2882 Jacket Sizes M-XL/XXL
- GUIN2882 Vest Sizes M-XL/XXL

At just 14 oz. each and the core of the BIS line, this jacket or vest provides plenty of warmth without weight or bulk. Tabs on the collar and elastic cuff (jacket only) fasten these lightweight liners securely in place. Both feature two-way YKK zippers, two generous pockets and interior zippered pockets where they pack away. Nylon shell/polyester insulation. Washable. Colors: 75)Ioden, 87)AP camo, 99)black. International origin.

APPAREL AND ACCESSORIES

**GORE-TEX® PACLITE JACKET WITH HOOD**  
GU4B3120      Sizes M-XL/XXL

Seam-sealed and constructed of breathable, waterproof GORE-TEX® to meet the most demanding conditions, this lightweight jacket packs into the zip-off hood so you can carry it anywhere. The adjustable-fit hood comes complete with a bill for more complete protection in the rain. Raglan sleeve construction is much more efficient in repelling water. Drawstring waist; adjustable Velcro cuffs.



BLAZE TIKKA CAP



BLACK SAKO CAP

**GORE-TEX® PACLITE PANT**  
CU4B3120      Sizes M-XL

Waterproof and breathable, these seam-sealed performance pants will take on the wettest field conditions. Elasticized waist provides a comfortable stretch; over-the-boot zipper for easy on/off. Washable. Color: 87)AP camo. International origin. Average inseam 30".



**HUNTING PACK WITH STOOL**  
JA235B

This stool carries the load on your back or on the ground. Features padded non-slip shoulder straps and a tubular steel frame to support any load.

AMERICAN  
BIG GAME  
HUNTER



## KNIVES AND RIFLE CASES



AMBI CAPER / SKINNER SET  
JK714A03



AMBI HUNTER  
JK711A02



AMBI DROP POINT HUNTER  
JK712A02



AMBI SKINNER W/GUT HOOK  
JK710A02



LEGACY LONG GUN CASE WITH  
EXTRA BARREL POCKET  
SFOU338009954



WAXWARE GUN CASE  
SFOU100975



## SAFARI COLLECTION

AMERICAN  
BIG GAME  
HUNTER

### Sako Rifles Star in Versus' *Dangerous Game* TV Series

#### Sako — the Gun of Choice When Your Life Depends on It.

"You get the lion or the lion gets you," wrote legendary scribe Robert Ruark. And that's the premise of *Dangerous Game*, one of Versus' (formerly OLN) highest rated series. "The amps are definitely a little higher in this series than most," says Chris Dorsey of Denver-based Orion Multimedia, the producer of *Dangerous Game* as well as *The World of Beretta*. As the title implies, the series features hunts for the planet's deadliest beasts: elephant, Cape buffalo, lion, leopard, grizzly, and others.



An unforgettable lion charge is captured during the filming of Versus' hit "Dangerous Game" series. The producers selected Sako rifles, for when your life is on the line, you want the best. Editor's note: No hunters were harmed during the filming of this series.

#### KALAHARI SAFARI VEST

##### GU27

The collective experience of our African Professional Hunter Group was the guiding force in the design and construction of this Teflon®-finished, cotton twill vest. It features two signature Beretta recoil pads, shotgun load cartridge loops with flap, and double-entry lower pockets. With function and performance in mind, details such as extra strapping for shell pocket support and back vent for air circulation were built in.



#### KALAHARI SAFARI JACKET

##### GU28

An extraordinarily functional safari jacket that would have done Hemingway or Ruark proud. From the loops for 12-gauge or .375 H&H shells above the left pocket to working epaulets for canteen or binoculars, freedom of movement pivot sleeves, gusseted underarms, and a button-off buckle adjustable belt. Preshrunk heavyweight cotton twill with stain-resistant Teflon® finish. Pleated back affords plenty of shoulder movement; internal load-bearing strapped front pockets.

#### RAZORGRASS OVERLAY PANT

##### CU10

The perfect complement to your Kalahari Safari Jacket or Vest. Made of the same prewashed cotton twill with stain-resistant Teflon® finish, this pant features support strapping to keep their shape when you fill the pockets. Articulated knees keep you comfortable through the longest treks. Nylon abrasion-resistant front pocket liner, quick load shell pockets, and snake boot tabs are a testament to the hunter's needs.

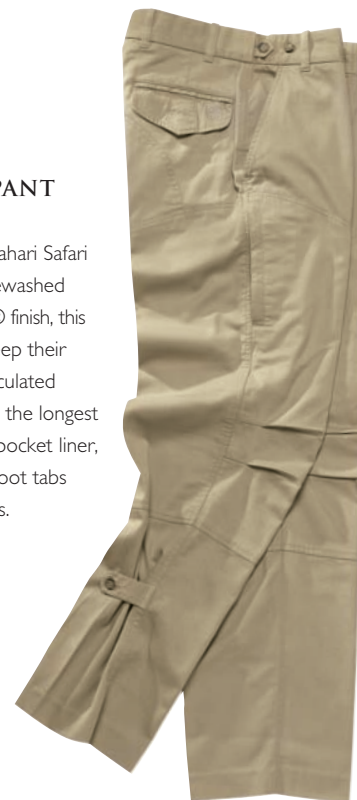



CHIARA CAINERO (ITA) - SKEET - WORLD CUP 2006: GOLD MEDAL. EUROPEAN CHAMPIONSHIP 2006: GOLD MEDAL. WORLD CHAMPIONSHIP 2006: SILVER MEDAL



INTRODUCING  
VICTORY SHOOTER

Olympic gold medals. There's no more reliable gauge of gunmaking excellence. From the 1956 to the 2004 Games, Beretta shooters have stood on the top podium eleven times, and brought home nine silver and eleven bronze medals. Since 1978, world-class competitors have used Berettas to bring home a total of 147 world championship medals in trap, double trap and skeet. The 2008 Olympics in Beijing will once again test the mettle of the world's best shooters and the world's best guns. And while getting to the top is difficult, maintaining dominance is even harder. Beretta is committed to staying on top, and keeping you there, too.

To be the best, Victory Shooters require dependable performance. Not just from themselves, but from their shotgun and the specialized apparel and accessories that work together to give them a competitive advantage. Designed for maximum performance in any event, Beretta's competition guns and clothing are the epitome of the craft, a testament to optimum control and reliability — as gold medal winners worldwide will attest.

# VICTORY SHOOTER

## UGB25 XCEL

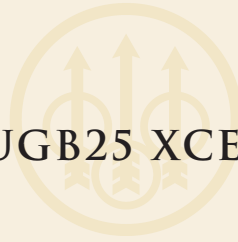

UGB25 XCEL JUX5T10

### SHORT BARREL RECOIL

The operating principle of the Beretta UGB25 Xcel semiautomatic gun with break-open barrel is based on short recoil, which keeps the internal parts of the gun clean even after prolonged use. The short recoil (and low barrel axis position) almost completely compensates for muzzle jump during firing, with quicker and easier realignment of the barrel on the target for the next shot. The low barrel axis position transmits the recoil forces in line with the shooter's shoulder, thus minimizing felt recoil.



### RECEIVER

The Beretta UGB25 Xcel features the unmistakable touch of Giugiaro Design. The ergonomically rounded back of the light alloy receiver fits smoothly into the stock, allowing quick and instinctive target acquisition. The polished sides contrast pleasingly with the other matte anti-glare surfaces. The streamlined receiver and the newly designed fore-end with its extended checkered configuration combine to give the UGB25 Xcel an extremely attractive look.

### DOUBLE RECOIL DAMPER FOR BREECH BOLT

The two technopolymer recoil dampers of the breech bolt cushion its impact on the bottom of the receiver, reducing vibration and increasing the life of the gun.

### SIDE FEED, BOTTOM EJECTION

The cartridge carrier receives the second cartridge on the right-hand side of the receiver, making it immediately ready for use. It is chambered automatically through the feeding port after the first round in the cartridge chamber has been fired. The design of the cartridge carrier button and its position on the receiver ensure quick and easy removal of the cartridge on the carrier. The ejection port is in the bottom of the receiver. The ejector expels the spent hull downward, away from the shooter and nearby competitors, and is user-friendly for both right- and left-hand shooters.



UGB25 XCEL



**UGB25 Xcel**



**HAND POSITION INDICATOR ON THE RECEIVER**

In front of the ejection port is a polymer insert used to indicate the position of the hand relative to the fore-end during firing to prevent contact with the hulls as the spent cartridges are ejected.



**TRIGGER PLATE**

The trigger plate is made entirely of high-resistance fiberglass-reinforced technopolymer and features self-lubrication of the firing mechanism, good vibration absorption and thermal stability for improved "feel" in cold weather. It is designed specifically to optimize the ergonomics. The safety button is in the standard position (for right-handed use), but it may be reversed for left-handed use by a qualified gunsmith.

**OPTI-BORE BARREL®, OPTIMACHOKE® TUBES**



All versions of the UGB25 Xcel come with an Optima-Bore® barrel with a lengthened forcing cone for enhanced pattern distribution sensitivity, reduced felt recoil and shot velocity optimization.

Team Beretta shooter Scott Robertson uses the UGB25 Xcel to trick shoot at the 2007 Grand American Trapshoot. The UGB25 Xcel was unveiled during this event.



**UGB25 XCEL**

<b>GAUGE</b>	12
<b>CARTRIDGE CHAMBER</b>	2¾" (70MM)
<b>OPERATION</b>	SEMI-AUTOMATIC, WITH BREAK-OPEN BARREL, SHORT RECOIL
<b>LOCKING SYSTEM</b>	ELEVATED LOCKING BLOCK
<b>RECEIVER</b>	LIGHT ALLOY WITH DOUBLE BREECH BOLT RECOIL ABSORBER
<b>BARREL</b>	THREE-ALLOY STEEL, FULLY CHROMED INSIDE. OPTIMA BORE PROFILE
<b>BARREL LENGTH</b>	30" ; 32"
<b>RIB</b>	VENTILATED
<b>SAFETY</b>	BUTTON-OPERATED, ON TRIGGER GUARD; REVERSIBLE FOR LEFT-HANDED SHOOTER
<b>STOCK, FORE-END</b>	WALNUT, CHECKERED. ADJUSTABLE DROP. CAST ON OR CAST OFF
<b>RIB TYPE</b>	¼" X ¼"
<b>LENGTH OF PULL</b>	14.09" – 14.88" WITH MEDIUM GEL TEK RECOIL PAD
<b>WEIGHT</b>	8.1-9.0 LBS*

\*WEIGHTS ARE APPROXIMATE, DEPENDENT ON WOOD DENSITY AND BARREL LENGTH.

# VICTORY SHOOTER



## DT10 TRIDENT FAMILY

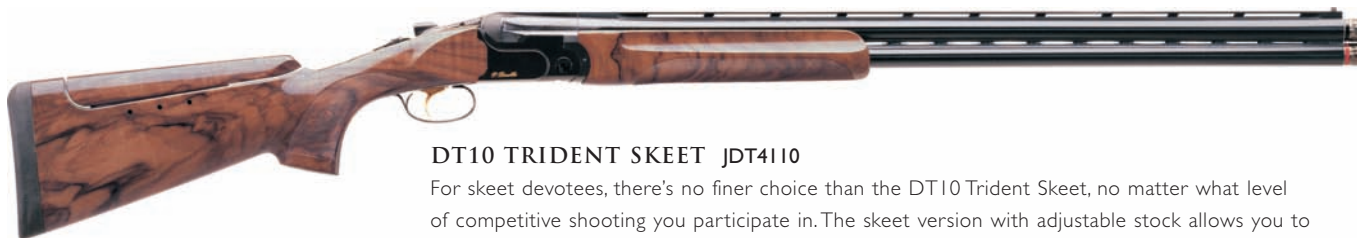

### DT10 TRIDENT SKEET JDT4110

For skeet devotees, there's no finer choice than the DT10 Trident Skeet, no matter what level of competitive shooting you participate in. The skeet version with adjustable stock allows you to regulate your personal sight picture. Beretta's patented "Memory System" lets you remove and replace the comb without losing your individual settings. The Optima-Bore® barrel system with Optimachoke® tubes improves shot pattern distribution and velocity, and felt recoil reduction.



### DT10 TRIDENT TRAP COMBO JDT3130

Designed specifically for American trap, the DT-10 bottom single has an adjustable point of impact, to allow the shooter to control their shot spread to suit their individual needs. In addition, it features a parallel comb with adjustable Memory System stock and the Optima-Bore barrel system with optimachoke tubes, which improves shot pattern distribution and velocity. It is available as a top or bottom single only, and also as a combo with the over/under barrels.



### DT10 TRIDENT

The initials "DT" are an abbreviation of "Detachable Trigger," emphasizing the efficiency and simplicity of the trigger group release system.

### DT10 TRIDENT TRAP COMBO

### DT10 TRIDENT SKEET

<b>ACTION</b>	LOW PROFILE MONOLITHIC BOX LOCK	
<b>GAUGE</b>	12	
<b>CHAMBER</b>	3"	
<b>WOOD FINISH</b>	GLOSS	
<b>STOCK/FORE-END</b>	HIGHLY SELECTED WALNUT, CHECKERED	
<b>STOCK DROP – COMB</b>	1.5**	1.375**
<b>STOCK DROP – HEEL</b>	2.28**	2.125**
<b>BUTT PLATE</b>	FULL BLACK RUBBER	
<b>SAFETY</b>	MANUAL	
<b>TRIGGER</b>	SINGLE SELECTIVE, ADJUSTABLE FOR LENGTH OF PULL	
<b>FORE-END</b>	BEAVERTAIL, WIDE	BEAVERTAIL
<b>TRIB TYPE</b>	PROGRESSIVE STEP, 3/8" X 5/16" OR 3/8" X 3/8" (BOT-TOM SINGLE)	FLAT, 3/8" X 5/16"
<b>SIGHT</b>	WHITE FRONT BEAD, STEEL MID-BEAD	
<b>WEIGHT</b>	8.8 LBS	8.8 LBS
<b>CARRY CASE</b>	YES	

\*MINIMUM VALUES WITH LOWERED COMB.

WEIGHTS ARE APPROXIMATE, DEPENDENT ON WOOD DENSITY AND BARREL LENGTH.



DT10 TRIDENT FAMILY



5  
World championships  
*out-of-the-box!*

**DT10 TRIDENT L SPORTING JD7210**

Outside of our Premium Guns, the DT10 is the top of the Beretta line—a shotgun that’s the ultimate in competitive arms. For sporting clays, the DT10 L Sporting is the shotgun of choice. Like all Beretta DT10s, it features an ergonomic top lever and a detachable trigger assembly that can be removed from the frame without tools for cleaning or maintenance. This masterpiece also features a modified cross-bolt locking system with superior strength. The “L” receiver is embellished by fine floral scroll engraving.



**DT10 TRIDENT SPORTING JD7100**

For sporting clays, the DT10 Sporting is the shotgun of choice. Like all Beretta DT10s, it features an ergonomic top lever and a detachable trigger assembly that can be removed from the receiver without tools for cleaning or maintenance. This masterpiece also offers a modified cross-bolt locking system with superior strength and Optima-Bore® barrels with Optimachoke® tubes. The single trigger is selective, the stock boasts a rounded rubber recoil pad, the fore-end is Schnabel.



**BERETTA SELECT CUSTOMER PROGRAM OFFERS 10-YEAR WARRANTY**

Visit our Beretta website to learn more about the Beretta Select Customer (BSC) program. At an extremely modest cost the BSC program gives the competitive shooter peace of mind long after the standard warranty has expired. BSC allows you to enjoy three years of free annual shotgun inspection and refurbishment, an extended 10-Year Service Plan, BSC Service Passport and more. Visit the Beretta website for complete information.

**DT10 TRIDENT L SPORTING**

<b>ACTION</b>	LOW PROFILE MONOLITHIC BOX LOCK
<b>GAUGE</b>	12
<b>CHAMBER</b>	3"
<b>WOOD FINISH</b>	GLOSS
<b>STOCK/FORE-END</b>	HIGHLY SELECTED WALNUT, CHECKERED
<b>STOCK DROP – COMB</b>	1.50"
<b>STOCK DROP – HEEL</b>	2.36"
<b>BUTT PLATE</b>	FULL BLACK RUBBER
<b>SAFETY</b>	MANUAL
<b>TRIGGER</b>	SINGLE SELECTIVE, ADJUSTABLE FOR LENGTH OF PULL
<b>FORE-END</b>	SCHNABEL
<b>RIB TYPE</b>	FLAT, 3/16" X 5/16"
<b>SIGHT</b>	WHITE FRONT BEAD, STEEL MID-BEAD
<b>WEIGHT</b>	8.0 LBS*
<b>CARRY CASE</b>	YES

\*WEIGHTS ARE APPROXIMATE, DEPENDENT ON WOOD DENSITY AND BARREL LENGTH.

# VICTORY SHOOTER



## 682 GOLD E FAMILY

CHOOSE YOUR  
POINT OF IMPACT



### 682 GOLD E TRAP BOTTOM SINGLE J682E20

Beretta is proud to introduce the 682 Gold E Trap bottom single version to further complete the 682 E family of products. Designed specifically for the American Trap market. The bottom single features a fully adjustable rib. The bottom single version only (non-combo) will be available solely with the 34-inch barrel with adjustable rib. Two combo versions will also be available: a 34-inch adjustable bottom single with a 30-inch over/under, and a 34-inch adjustable bottom single barrel with 32-inch over/under. All models will be equipped with a factory adjustable comb with Memory System, and the same adjustable trigger shoe that is standard on the 682 Gold E Trap family.

The 682 E family has been established as a premier firearm in competition shooting, building on a tradition of durability, reliability, and performance. With the elliptical graphic on the low profile receiver, and nickel-alloy steel for strength and durability, this family is the perfect blend between technology and style, heritage and innovation.



### FULLY ADJUSTABLE RIB

The 682 Gold E Trap Bottom Single's fully adjustable rib allows the shooter to change the point of impact, making the gun truly customizable to suit the individual shooter's needs.



### 682 GOLD E TRAP BOTTOM SINGLE

MODEL	CODE	GAUGE	BARREL	CHOKE
682 GOLD E TRAP BOTTOM SINGLE	J682E25	12	34"	OBTR
682 GOLD E TRAP BOTTOM SINGLE COMBO	J682E20	12	30"/34"	OBTR
682 GOLD E TRAP BOTTOM SINGLE COMBO	J682E22	12	32"/34"	OBTS



682 GOLD E FAMILY



**682 GOLD E TRAP J682E10**

Whatever your target discipline, the 682 Gold E can help you dominate. For the trap shooter, you'll find the 682 Gold E Trap perfect for your passion. It features an adjustable comb and Beretta's Optima-Bore barrel system with long forcing cone and overbored internal bore diameter. And the distinctive receiver engraving and inlay pattern immediately identify it as a target gun.



**682 GOLD E SKEET J682E40**

The 682 Gold E skeet features special skeet stock with rounded rubber recoil pad, beavertail fore-end, tapered top rib with white front sight, It also features a non-selective adjustable single trigger and Optima-Bore® barrels that reduce felt recoil and Optimachoke® or Extended Optimachoke® tubes ensuring consistent shot distribution and the adjustable stock with Memory System .

	GOLD E TRAP	GOLD E SKEET
<b>ACTION</b>	LOW PROFILE, IMPROVED BOX LOCK	
<b>GAUGE</b>	12	12
<b>CHAMBER</b>	3"	3"
<b>WOOD FINISH</b>	GLOSS	
<b>STOCK/FORE-END</b>	SELECTED WALNUT, CHECKERED. MONTECARLO-STYLE, MEMORY SYSTEM	SELECTED WALNUT, CHECKERED
<b>STOCK DROP - COMB</b>	1.50"	1.50"
<b>STOCK DROP - HEEL</b>	2.28"	2.36"
<b>BUTT PLATE</b>	FULL BLACK RUBBER	
<b>SAFETY</b>	MANUAL	
<b>TRIGGER</b>	SINGLE SELECTIVE WITH SELECTOR LOCK, ADJUSTABLE FOR LENGTH OF PULL	SINGLE SELECTIVE, ADJUSTABLE FOR LENGTH OF PULL
<b>FORE-END</b>	BEAVERTAIL	BEAVERTAIL
<b>RIB TYPE</b>	PROGRESSIVE STEP 3/8" X 3/8"	FLAT 3/8" X 5/16"
<b>SIGHT</b>	WHITE FRONT BEAD WITH STEEL MID-BEAD	
<b>WEIGHT</b>	8.8 LBS	7.5 LBS
<b>CARRY CASE</b>	YES	YES

\*WEIGHTS ARE APPROXIMATE, DEPENDENT ON WOOD DENSITY AND BARREL LENGTH.



**ADJUSTABLE STOCK WITH MEMORY SYSTEM**

The adjusting device is made of carbon reinforced technopolymer guaranteeing robustness and durability.



**ADJUSTABLE TRIGGER**

The single trigger is adjustable for length of pull.

# VICTORY SHOOTER



## 687 SILVER PIGEON FAMILY



687 SILVER PIGEON II SPORTING J687406



687 SILVER PIGEON III SPORTING J6874A0



At the core of the 687 Silver Pigeon III Sporting is our legendary 687-series receiver. This low-profile, positive-locking, low-maintenance action ensures that your off-hand stays as close as possible to the bore-axis; in this manner, whatever you point to is exactly where the shot goes. The receiver is embellished with a scroll and game scene designed by our most experienced Master Engravers in Gardone, Italy. The way this pattern is executed on the receiver makes it virtually as striking as if it had been hand-engraved, but without the price tag to match.

### 687 SILVER PIGEON II    687 SILVER PIGEON III

	687 SILVER PIGEON II	687 SILVER PIGEON III
<b>ACTION</b>	LOW PROFILE, IMPROVED BOX LOCK	
<b>GAUGE</b>	12, 20, 28	
<b>CHAMBER</b>	3" (28 GAUGE 2 <sup>3</sup> / <sub>4</sub> ")	
<b>WOOD FINISH</b>	OIL	OIL
<b>STOCK/FORE-END</b>	SELECTED WALNUT, CHECKERED	
<b>STOCK DROP - COMB</b>	1.50"	
<b>STOCK DROP - HEEL</b>	2.36"	
<b>BUTT PLATE</b>	FULL BLACK RUBBER	
<b>SAFETY</b>	MANUAL	
<b>TRIGGER</b>	SINGLE SELECTIVE	
<b>FORE-END</b>	SCHNABEL	
<b>RIB TYPE</b>	3/8" X 5/16"	
<b>SIGHT</b>	METAL FRONT BEAD	
<b>WEIGHT</b>	6.8 LBS (12 GAUGE); 6.2 LBS (20 GAUGE)	
<b>CARRY CASE</b>	YES	YES

687 DIAMOND PIGEON



**687 EELL DIAMOND PIGEON SPORTING J687956**

One of the most elegant, finely balanced and responsive double barrel shotguns in the world, the 687 EELL Diamond Pigeon 12 gauge is the epitome of luxury and performance for the competitive shooter. Beretta's extensive hand-chased engraving and highly figured select walnut set this shotgun apart from all others. Just like the field version in every luxurious detail with the added benefit of a wider rib for better target acquisition.



Like a beautiful painting on canvas, the EELL Diamond Pigeon's side-plates are exquisitely engraved with game scenes.

**687 EELL DIAMOND PIGEON SPORTING**

<b>ACTION</b>	LOW PROFILE, IMPROVED BOX LOCK
<b>GAUGE</b>	12, 20, 28, .410
<b>CHAMBER</b>	12/20 GAUGE: 3"; 28 GAUGE: 2¾", .410 GAUGE: 2¾"
<b>WOOD FINISH</b>	OIL
<b>STOCK/FORE-END</b>	HIGHLY SELECTED WALNUT, CHECKERED
<b>STOCK DROP - COMB</b>	1.50"
<b>STOCK DROP - HEEL</b>	2.36"
<b>BUTT PLATE</b>	FULL BLACK RUBBER
<b>SAFETY</b>	MANUAL
<b>TRIGGER</b>	SINGLE SELECTIVE
<b>FORE-END</b>	SCHNABEL
<b>RIB TYPE</b>	¾" X ⅜"
<b>SIGHT</b>	WHITE FRONT BEAD STEEL MID-BEAD
<b>WEIGHT</b>	7.5 LBS.



**686 WHITE ONYX J6868A0**

**686 WHITE ONYX SPORTING**

<b>ACTION</b>	LOW PROFILE, IMPROVED BOX LOCK
<b>GAUGE</b>	12 ONLY
<b>CHAMBER</b>	3"
<b>WOOD FINISH</b>	OIL
<b>STOCK/FORE-END</b>	SELECTED WALNUT, CHECKERED
<b>STOCK DROP - COMB</b>	1.50"
<b>STOCK DROP - HEEL</b>	2.36"
<b>BUTT PLATE</b>	FULL BLACK RUBBER
<b>SAFETY</b>	MANUAL
<b>TRIGGER</b>	SINGLE SELECTIVE
<b>FORE-END</b>	SCHNABEL
<b>RIB TYPE</b>	¾" X ⅜"
<b>SIGHT</b>	WHITE FRONT BEAD, STEEL MID-BEAD
<b>WEIGHT</b>	30" 7-8 LB.; 32" 8-8.5 LB. *

**686 WHITE ONYX SPORTING**

Designed to fulfill everything shooters look for in a competition shotgun, the Beretta 686 White Onyx Sporting over-and-under proves that you can still get brilliant results on a reasonable budget. It features a receiver machined with the Beretta distinctive Dura-Jewel pattern and a nickel-alloy finish contrasting with the satin side panels and the gold-plated trigger. The Optima-Bore® barrels reduce felt recoil and the Optimachoke® tubes guarantee a perfect shot pattern and a regular distribution of pellets.

WEIGHTS ARE APPROXIMATE, DEPENDENT ON WOOD DENSITY AND BARREL LENGTH.

# VICTORY SHOOTER

## TEKNYS GOLD FAMILY



**AL391 TEKNYS GOLD TARGET J391T00**

The AL391 Teknys Gold is Beretta's ultimate autoloader. With an added suite of features, it becomes the AL391 Teknys Gold Target, the ultimate autoloader for sporting clays, skeet, and trap. You'll pick it out instantly. The receiver is distinctively engraved with a stylized Beretta logo on the left side, and both sides feature blue-enameled inserts that unite the receiver and buttstock in a stylistic look that distinguishes the Target model from the green-enameled field gun. The self-compensating gas operating system regulates ammunition of varying ballistics, and has been thoroughly proven in the successful AL391 Urika series. Fitted in the buttstock of every Teknys Gold Target shotgun is an 8.5-ounce recoil reducer based on the spring-mass system pioneered in the original 3½-inch, 12-gauge Xtrema. If reduced weight is required by the shooter, the system is easily removed without the need of a gunsmith. Those who want to keep a forward balance and add weight can opt to use the supplied magazine cap weight/balance system. Through the use of secure interchangeable ribs, one truly has the ultimate "do-it-all" Target gun for trap, skeet, and sporting clays. The inclusion of an additional stepped rib provides one the opportunity to have a second sight picture for trap targets.



**AL391 TEKNYS GOLD SPORTING J391T70**

The AL391 Teknys Gold is Beretta's ultimate field autoloader. With an added suite of standard and optional features, it becomes the ultimate autoloader for the sporting clays course. Along with its distinctively engraved Beretta logo and blue enamel inserts, every Teknys Gold Sporting has an 8.5-ounce recoil reducer fitted in the buttstock. Among its many sporting features is a fast bolt release that allows for fatigue-free shootings when shoot-offs last all afternoon.

### AL391 TEKNYS GOLD SPORTING

### AL391 TEKNYS GOLD TRAP

### AL391 TEKNYS GOLD TARGET

	SEMI-AUTOMATIC GAS OPERATION WITH SELF-COMPENSATING EXHAUST VALVE		
<b>ACTION</b>	SEMI-AUTOMATIC GAS OPERATION WITH SELF-COMPENSATING EXHAUST VALVE		
<b>GAUGE</b>	12, 20	12	12
<b>CHAMBER</b>	3"	3"	3"
<b>WOOD FINISH</b>	OIL	OIL	OIL
<b>STOCK/FORE-END</b>	SELECTED WALNUT, CHECKERED		
<b>STOCK DROP - COMB</b>	1.34"	VARIABLE	VARIABLE
<b>STOCK DROP - HEEL</b>	2.36"	2.36"	2.36"
<b>RECOIL PAD</b>	GEL-TEK	GEL-TEK	GEL-TEK
<b>SAFETY</b>	CROSS-BOLT, REVERSIBLE FOR LEFT-HANDED SHOOTERS		
<b>TRIGGER</b>	GOLD		
<b>FORE-END</b>	ULTRA SLIM		
<b>RIB TYPE</b>	FLAT, 3/8" X 5/16"	STEPPED	STEPPED AND FLAT
<b>SIGHT</b>	WHITE FRONT BEAD, STEEL MID BEAD		
<b>WEIGHT</b>	7.9 LBS (12 GAUGE), 6.6 LBS (20 GAUGE) *	8 LBS *	8 LBS *
<b>CARRY CASE</b>	YES	YES	YES

WEIGHTS ARE APPROXIMATE, DEPENDENT ON WOOD DENSITY AND BARREL LENGTH.

AL391 URIKA 2

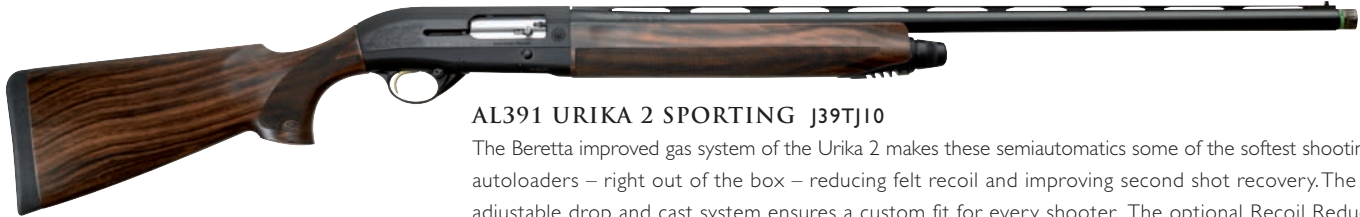

**AL391 URIKA 2 SPORTING J39TJ10**

The Beretta improved gas system of the Urika 2 makes these semiautomatics some of the softest shooting autoloaders – right out of the box – reducing felt recoil and improving second shot recovery. The adjustable drop and cast system ensures a custom fit for every shooter. The optional Recoil Reduction System device can be installed in the X-Tra Grain stock.

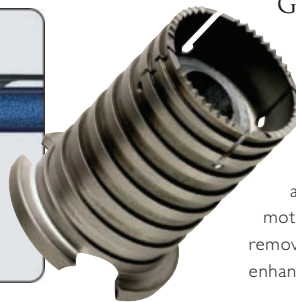
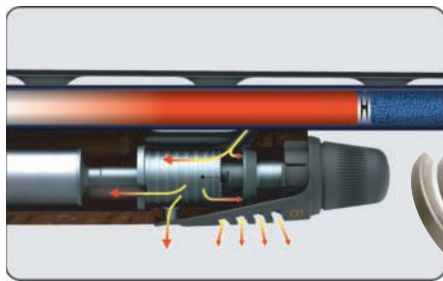

**GAS OPERATION**

**THE BERETTA GAS SYSTEM IS TWICE AS FAST AS ANY OTHER OPERATING SYSTEM.**

The gas system has been improved by the addition of a spinning and self-cleaning action. As gas pressure is fed into the gas cylinder, a series of expandable fingers on the piston expand outwardly to clean the gas cylinder as the action cycles. Additionally, the gas piston is imparted with a spinning motion and “scraper teeth” to ensure carbon deposits are thoroughly dislodged and removed from the gas system. This improved cleaning action greatly contributes to enhanced reliability and longer functioning shooting periods between cleaning.

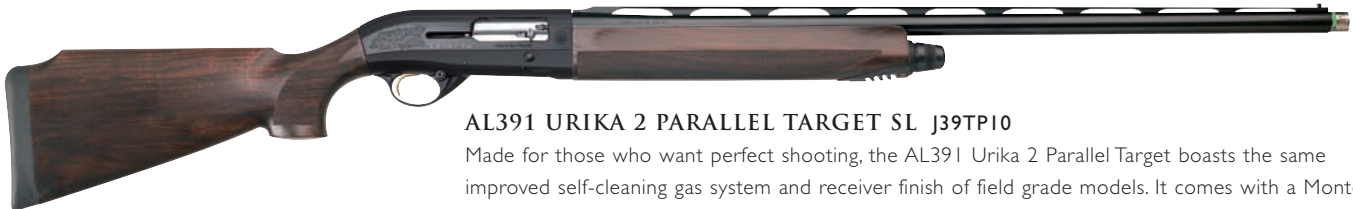

**AL391 URIKA 2 PARALLEL TARGET SL J39TP10**

Made for those who want perfect shooting, the AL391 Urika 2 Parallel Target boasts the same improved self-cleaning gas system and receiver finish of field grade models. It comes with a Monte Carlo stock with parallel comb and reduced grip radius. This facilitates the grip and instinctive pointing, especially for individuals with smaller hands. The shotgun has all the professional characteristics of the Beretta competition semiautomatics.

**AL391 URIKA 2  
PARALLEL TARGET SL**

**AL391 URIKA 2  
GOLD SPORTING**

**AL391 URIKA 2 SPORTING**

	SEMI-AUTOMATIC GAS OPERATION WITH SELF-COMPENSATING EXHAUST VALVE		
<b>ACTION</b>	SEMI-AUTOMATIC GAS OPERATION WITH SELF-COMPENSATING EXHAUST VALVE		
<b>GAUGE</b>	12	12	12, 20
<b>CHAMBER</b>	3"	3"	3"
<b>WOOD FINISH</b>	X-TRA GRAIN	OIL	X-TRA GRAIN
<b>STOCK/FORE-END</b>	SELECTED WALNUT, CHECKERED		
<b>STOCK DROP – COMB</b>	VARIABLE	1.34"	1.34"
<b>STOCK DROP – HEEL</b>	2.36"		
<b>RECOIL PAD</b>	FULL BLACK RUBBER		
<b>SAFETY</b>	CROSS-BOLT, REVERSIBLE FOR LEFT-HANDED SHOOTERS		
<b>TRIGGER</b>	GOLD		
<b>FORE-END</b>	SLIM		
<b>RIB TYPE</b>	STEPPED	FLAT, 3/8" X 5/16"	
<b>SIGHT</b>	WHITE FRONT BEAD, STEEL MID BEAD		
<b>WEIGHT</b>	7.8 LBS. (12 GAUGE); 6.9 LBS. (20 GAUGE) *		
<b>CARRY CASE</b>	YES	YES	YES

WEIGHTS ARE APPROXIMATE, DEPENDENT ON WOOD DENSITY AND BARREL LENGTH.

# VICTORY SHOOTER



## THE BERETTA TEAM

Can you imagine winning the World Shotgun Championship at 16 years old? The U.S.A.'s Vincent Hancock did just that this past year in Lonato, Italy, with an out-of-the-box Beretta DT10. He became the youngest shooter ever to win the world championship.

Hancock joins a prestigious list of some of the most respected and talented names in the sport of competitive shooting who embody the

winning spirit of Beretta. From the Olympics to regional shoot-offs, a Beretta is usually in the hands of the champion. Beretta's gallery of champions from around the world are a testament to their skill, determination and performance under pressure. Like Beretta's competition guns, they represent the epitome of their craft.



### VINCE HANCOCK COMPETES WITH AN EYE TOWARDS BEIJING

At age 16, Vincent Hancock took the world of international skeet shooting by storm, winning a gold medal at his World Championship debut in 2005. Hancock bested the international field using an out-of-the-box Beretta DT10 Trident. Two years later, Hancock continues to dominate as he marches toward his goal of representing the USA at the 2008 Olympic Games. He stills uses a DT10 straight out of the box and he still is setting world records. Now with the U.S. Army Marksmanship Unit, Hancock recently took Gold in the Men's Skeet Event at the 2007 Pan American Games held in Rio De Janeiro, Brazil. His score of 147 + 2 broke his own world record.

### DAN CARLISLE

Member of Team Beretta and one of America's top sporting shooters and instructors, Dan is an Olympic medal winner (Bronze in Skeet at 1984 Games), World Champion and 13-time National Champion. He has the distinction of having won more championships in more shotgun disciplines than any other U.S. shooter. Most recently, Dan and his Beretta DT10 won the 19th NSCA National Championships at the National Shooting Complex in San Antonio, Texas.

### DIANE SORANTINO

Team Beretta shooter Diane Sorantino recently clinched the NSCA National Championships. The current World F.I.T.A.S.C. Woman's Champion, Diane continued her winning streak using her Beretta Teknys Gold. In 2006 she was inducted into the National Sporting Clays Association Hall of Fame. Diane has captured almost every National and World Title in the disciplines of English Sporting and F.I.T.A.S.C. in her competitive shooting career. She proudly serves as the Chief of Police of Cape May, N.J.



## THE BERETTA TEAM



### GREGG WOLF

As a 20-year-old college student, Gregg became the first American, the first Junior competitor, and the youngest person ever to win the World F.I.T.A.S.C Championship. A member of Team Beretta, Gregg shoots a Beretta 687EELL. In a few short years, Gregg has captured 14 World and National titles, including four World Championships as a Junior. During his college years, he was a regular member on the All American Team and Team USA.

### JANET TAUSCH

A six-time Ladies Texas State Champion, two-time Ladies National 20-gauge Champion, and a six-time All-American, Team Beretta shooter Janet Tausch is a dominant force in the sport. Her most recent wins include the Five-Stand ladies title at the NSCA National Championships, the Ladies Concurrent at the 2007 National Sporting Clays Association US Open Championship, the 2007 World English Sporting Clays Championship, and the 2006 NSCA National Championship. Her shotgun of choice is the Beretta 687 EELL Diamond Pigeon.



### SCOTT ROBERTSON

For three-time World Champion and eight-time National Champion, Scott Robertson stepping to the awards stand has almost become as much a part of his life as shooting. A gold medalist at the 2003 ESPN Great Outdoor Games and 19--time All American, Robertson of Flower Mound, Texas, has Pan-American, Caribbean Cup and Ducks Unlimited National championships among his many accomplishments.

# VICTORY SHOOTER

## APPAREL AND ACCESSORIES



### B1ONE

The finest materials, impeccable Italian design, fully field-tested. Our new B1ONE line of shooting accessories reflects the essence of a world tailored to the needs of those passionate about the outdoor lifestyle. Built for the field and range, these bags look equally at home in the back of your Land Rover.

B1ONE luxury accessories feature more than just an attractive design, they showcase the most innovative technical properties. All the bags and cases are made of soft, longwearing canvas with genuine leather details and Beretta's personalized lining. Shaped handles and non-slip shoulder straps make for comfortable carry, with Beretta's exclusive thermo-formed leather protects your firearm. They are all of interational origin.

#### A. CA16119

Cartridge belt with inner thermo-shield and 26 elastic loops with leather reinforcement.

#### B. BS99119

25 shells hull pouch with belt.

#### C. BS96119

Small cartridge bag (max 4 boxes).

#### D. BS98119

50 shells pouch with belt.

#### E. SL13119

Leather and canvas shotgun sling with non-slip backing.

#### E. FOD20119

Take down case with thermo-formed tread that acts as a shock absorber. Fits up to 32".





APPAREL AND ACCESSORIES



RANGE BAG

RANGE BAG DELUXE



Zip bottom compartment for shoes or small firearms.

**BERETTA RANGE BAGS**

**JA102 RANGE BAG**

**JA103 RANGE BAG DELUXE**

Pack all your accessories in one, easy-access heavy-duty nylon shell bag that will keep everything within reach. Roomy enough to carry eyes, ears, a couple boxes of ammo, and a pistol. These bags feature adjustable interior dividers, padded shoulder straps and plenty of zippered exterior pockets. Range Bag measures 15" x 12" x 12"; Deluxe Range Bag measures, 15" x 12" x 14". Colors: A) blue/black, B) loden/Tuscany.



Adjustable padded, non-skid shoulder strap.

Movable Velcro® dividers.

Moisture-proof pocket.

Cleaning gear pocket.

**JA104 TRIDENT RANGE PACK**

This easy-carry range pack features a heavy-duty nylon shell, heavy-duty coil zippers, adjustable dividers, and articulated shoulder straps. Two integrated pistol pockets on each side and front padded pocket for shooting shields. 16" x 10" x 8".



**TRIDENT SMALL RANGE BAG**

**JA102A1 BLACK**

**JA102B1 LODEN/TUSCANY**

Constructed of tough 600-denier pack cloth for years of use, this compact bag has surprisingly spacious pockets to hold everything you need for a day of shooting. Padded, removable shoulder strap. 7" x 9" x 16".



# VICTORY SHOOTER

## APPAREL AND ACCESSORIES



Whether you're a beginner or an expert on the range, you can find comfort and security knowing that Beretta has just the right clothing and accessories to equip you.



### TWO-TONE CLAYS VEST

GT080146

Genuine leather accents this championship vest with functionally cooling mesh back and sides. Expandable front shell pockets; adjustable waist tabs; shooting glasses pocket.

### BERETTA BREAKTHROUGH SHOOTING GLASSES

OC12000109

From the first look you'll know that evolution in this case has given way to revolution. Once you see, feel and try on Beretta's Breakthrough Shooting/Sportsman Glasses, it will confirm your first impression. Three interchangeable lenses climb into a stylish hard case to protect their integrity:

- Yellow for poor atmospheric conditions like overcast skies and fog
- Vermillion for bright, sunny days
- Grey for those days when the weather can't make up its mind



### COMPETITION SHOOTING DOUBLE LOGO T-SHIRT

TS717294

One of the world's longest cotton fibers, Peruvian Tanguis yarn gives Beretta tees an unusually high luster and soft hand, yet greater tensile strength for unparalleled quality, and very little shrinkage. Beretta trademark on both arms, Trident logo on the chest.



APPAREL AND ACCESSORIES



**PINK TRIMMED SHOOTING VEST**

**GT920074 RIGHT-HANDED**

**GT930074 LEFT-HANDED**

A touch of pink piping and embroidery gives this performance shooting vest a dash of style. The shoulder notch on the shooting side allows for ease of fit. Other features include shooting glove pocket, elasticized waist, interior security pockets, ear protection hanger, and easy-breathe rear side panels. Cotton/poly/leather.



**TEAM BERETTA SHOOTER'S TOWEL  
SOG10**

This cotton towel helps keep those sweaty palms dry. The grommet hold and clip allow it to be clipped to a vest, belt, or bag. 16" x 24".



**LEATHER SPORTING CLAYS BELT**

**JA143A**

Top-of-the-line leather pouch is embossed with the Beretta logo and holds 100 shells and two choke tubes. Adjustable belt fits up to a 58" waist.



**WOMEN'S COMPETITION  
CHAMPION POLO**

**MD507298**

Stylish cap sleeves and proportions that flatter a women set this pure cotton interlock polo apart. Right-hand shooting patch, contrasting two-button placket, and Beretta collar logo.



**LEGACY LEATHER  
HULL POUCH**

**JA144A**

This vegetable-tanned leather and mesh pouch is embossed with the Trident logo and holds 100 shell hulls. Spring-loaded top and a Velcro® easy-unload bottom. Fits a 2" wide belt.

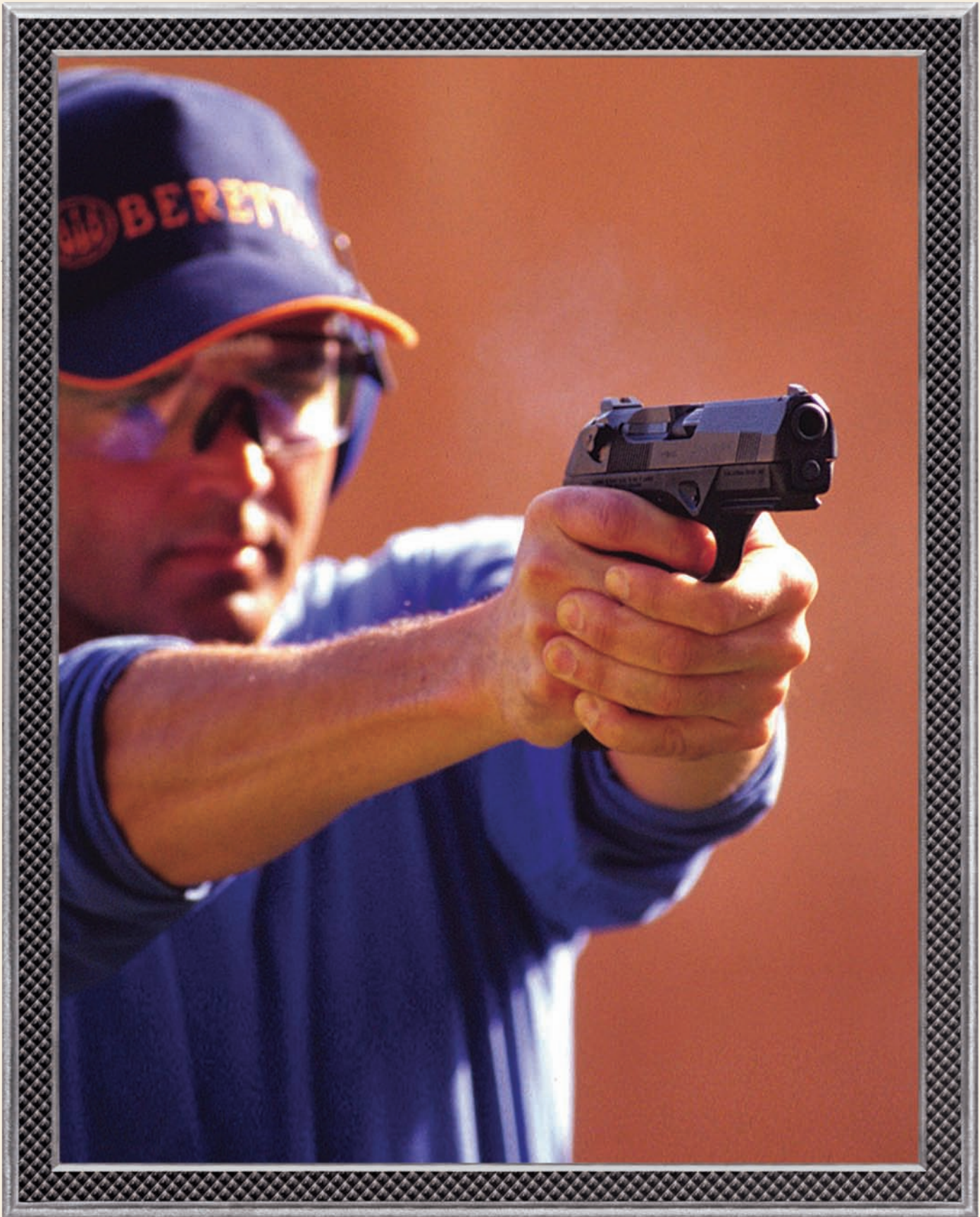



INTRODUCING  
AMERICAN PISTOL SHOOTER

Absolute reliability, consistent accuracy and optimal safety. Whether testing your skills in competition, polishing them at the target range, or defending your home and family, there are certain things you demand from your firearm. And — with no room for error — these are at the top of anyone's list. But beyond these essential traits, your pistol is an extension of your personality. Your preference may run to the fastest or lightest or most technologically advanced. Or to the familiar standbys that still feel perfect in the palm and right on the money at the range.

As a Beretta Pistol Shooter, you can also expect innovation, versatility, and superior design and workmanship. In the pistol stakes, Beretta wins — hands down. The automatic choice of marksmen, sportsmen, and military worldwide, Beretta pistols carry with them their own mystique and reputation. And deservedly so. A Beretta pistol is both a triumph of design and reliable performance, offering the user the most advantageous combination of form and function.

# AMERICAN PISTOL SHOOTER

## PX4 STORM FAMILY



PX4 STORM F & G



PX4 STORM C & D



PX4 STORM .45



PX4 STORM SD



PX4 STORM  
SUB-COMPACT



# PX4 Storm

### PX4 STORM JXF9F21

The Beretta Px4 Storm series was built around the belief that a firearm should be individualized to the operator. The Px4 Storm includes multiple trigger operating modes, which include our standard F model - double/single action; C model - constant action; D model - double action only; and the G model - double/single action with return to fire feature. All full size Px4 Storm Pistols feature a rotating barrel which makes for a low profile design with one of the strongest actions available. Also, you have a choice of three backstraps, three magazine release buttons, and two slide catch lever sizes. This is a gun you can make fit for your purposes. Extremely easy to disassemble without tools, the Px4 Storm personifies simplified field stripping: it cannot be reassembled incorrectly! Without compromising on Beretta's legendary ergonomics, reliability and performance, this lightweight technopolymer frame pistol defines Individualized Performance.

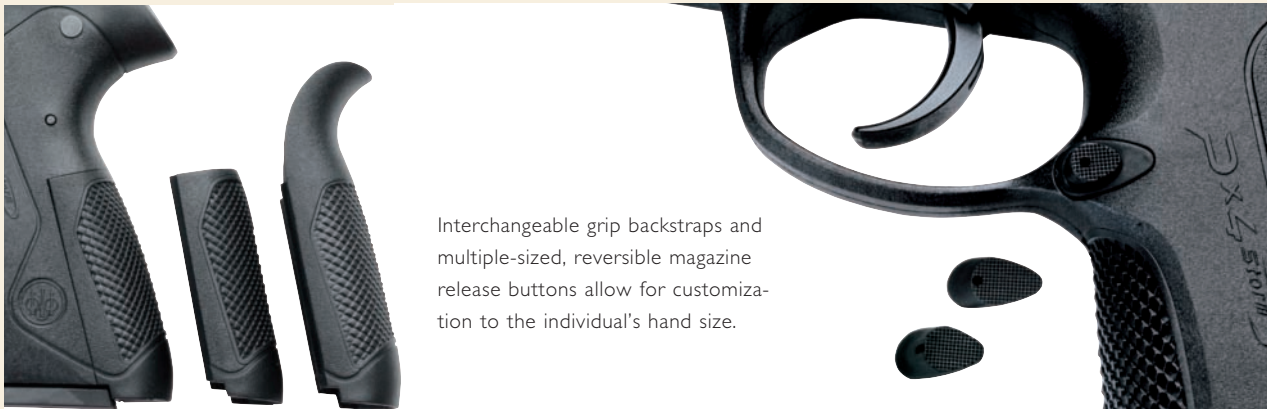

Interchangeable grip backstraps and multiple-sized, reversible magazine release buttons allow for customization to the individual's hand size.

# AMERICAN PISTOL SHOOTER

CUSTOMIZE TO YOUR HAND AND SHOOTING STYLE  
INDIVIDUALIZED PERFORMANCE.



Standard Super-Luminova sights give high targeting performance in all types of light conditions. With minimal exposure to light (or flashlight), this luminous material is “charged” and visible in low light.



Military Standard 1913 “Picatinny” standard accessory rail. Allows mounting of optional tactical lights and laser units.

*“I am a single female (mom) and just purchased my first firearm for self-home protection. After contemplating several competitors’ models, I went with the PX4 Storm, 9mm, and I am so glad that I did. The quality of Beretta is what sold me on the pistol. I also like the flexibility the PX4 Storm offers with different sized grips to make a custom fit to my hand.”*

— Brenda, Beretta Customer

14-ROUND MAGAZINE (.40 S&W)

JM4PX4014

17-ROUND MAGAZINE (9MM)

JM4PX917 (NOT SHOWN)



## PX4 STORM FULL SIZE

<b>CALIBER</b>	9MM OR .40
<b>OVERALL LENGTH</b>	7.59"
<b>OVERALL HEIGHT</b>	5.51"
<b>BARREL LENGTH</b>	4"
<b>SIGHT RADIUS</b>	5.7"
<b>GRIP WIDTH</b>	1.18"
<b>WEIGHT UNLOADED</b>	27.5 OZ.
<b>MAGAZINE CAPACITY (9MM)</b>	10, 17, 20 ROUNDS
<b>MAGAZINE CAPACITY (.40)</b>	10, 14, 17 ROUNDS

# AMERICAN PISTOL SHOOTER

## PX4 STORM SUB-COMPACT



### PX4 STORM SUB-COMPACT JXS9F21 (9MM) / JXF4F21 (.40 S&W)

The Beretta Px4 Storm Sub-Compact pistol is the most advanced sub-compact sidearm of its kind. Built around Beretta's latest Px4 modular technology, the Px4 Storm Sub-Compact delivers concealed carry handling with large frame firepower.

Available in two calibers (9mm and .40 S&W), the Px4 Storm Sub-Compact uses a very reliable locked breech and tilt barrel system, providing a more compact and lighter weight system. A stainless steel barrel requires less maintenance and is corrosion resistant, perfectly suited for concealment close to active, perspiring bodies.



No tools are required to replace the interchangeable backstrap and create an individualized fit for the user.

The pistol adapts to different hand sizes easily with interchangeable backstraps (included). An ambidextrous manual safety lever is positioned on both sides of the slide for easy access by all shooters. A reversible magazine release button can be mounted on either side and can quickly be replaced by a smaller and larger size button (optional). An interchangeable slide catch can also be replaced with an optional low-profile configuration. A standard Picatinny Rail (MIL-STD-1913) allows for an array of aftermarket accessories.

Patented SnapGrip™ Magazine Extender: Beretta's patented SnapGrip Magazine Extender flips down easily, maximizing the grip for larger hands.

### PX4 STORM SUB-COMPACT TYPE F

<b>CALIBER</b>	9MM, .40 S&W
<b>ACTION</b>	DOUBLE AND SINGLE
<b>OVERALL LENGTH</b>	6.2"
<b>OVERALL HEIGHT</b>	4.8"
<b>BARREL LENGTH</b>	3.0"
<b>SIGHT RADIUS</b>	4.6"
<b>GRIP WIDTH</b>	1.4"
<b>WEIGHT UNLOADED</b>	26.1 OZ
<b>MAGAZINE CAPACITY</b>	13 ROUNDS (9MM), 10 ROUNDS (.40 S&W)



PX4 STORM .45



**PX4 STORM .45 JXF5F25**

The new Beretta Px4 Storm .45 pistol is the most advanced sidearm of its kind. Built around Beretta's latest Px4 modular technology, the Px4 Storm .45 emphasizes maximum firepower in an ergonomic package while maintaining the same ease of handling and reliability Beretta pistols are famous for. The Px4 Storm .45 emphasizes power, ease of handling, superior performance and reliability.

The Px4 Storm .45 uses an exclusive, innovative Beretta-designed locked breech rotating barrel system, the strongest action ever developed by the Beretta engineering team. The light yet durable frame employs modern thermoplastics and interchangeability of parts, making the Px4 Storm .45 the ideal firearm for law enforcement use as well as personal defense.

**PX4 STORM .45**

<b>CALIBER</b>	.45 ACP
<b>ACTION</b>	DOUBLE AND SINGLE
<b>OVERALL LENGTH</b>	7.7"
<b>OVERALL HEIGHT</b>	5.5"
<b>BARREL LENGTH</b>	4.1"
<b>SIGHT RADIUS</b>	5.9"
<b>GRIP WIDTH</b>	1.4"
<b>WEIGHT UNLOADED</b>	28.2 OZ.
<b>MAGAZINE CAPACITY</b>	9 AND 10 ROUNDS

# AMERICAN PISTOL SHOOTER



## PX4 STORM .45 SD



### PX4 STORM .45 SD JXF5F45

The new Beretta Px4 Storm .45 Special Duty pistol is the most advanced sidearm of its kind, bar none. Built around Beretta's latest Px4 Storm modular technology, the Px4 Storm .45 SD emphasizes maximum firepower in any environment and any purpose.

The Px4 Storm .45 SD was originally designed to meet the rigorous specifications of U.S. S.O.C.O.M. and uses an exclusive, innovative Beretta-designed locked breech rotating barrel system and various materials and finishes capable of withstanding the toughest military applications. The light yet durable frame employs modern thermoplastics and interchangeability of parts, making the Px4 Storm .45 SD today's best choice for military and tactical law enforcement use as well as personal defense and serious pistol enthusiasts.

The ergonomic design, with its snag-free surfaces, ensures trouble-free insertion and holster extraction. A rounded trigger ensures correct hand firing position.

Also standard is a Picatinny Rail (MIL-STD-1913) under the barrel for accessories. An optimal grip angle ensures a correct line of sight and the rear upper part of the grip is curved and recessed to snugly fit and protect the shooter's hand. Thanks to a newly patented modular system, the pistol adapts to different hand sizes easily with interchangeable backstraps (included).

An ambidextrous and interchangeable manual safety lever is positioned on both sides of the slide for easy access by all shooters. In addition, an ambidextrous and interchangeable magazine release button can be mounted on either side and can quickly be replaced by a smaller and larger sized button (optional). An interchangeable slide catch can also be replaced with an optional low-profile configuration.

### PX4 STORM SD

<b>CALIBER</b>	.45 ACP
<b>ACTION</b>	DOUBLE AND SINGLE
<b>OVERALL LENGTH</b>	8.2"
<b>OVERALL HEIGHT</b>	5.7"
<b>BARREL LENGTH</b>	4.6"
<b>SIGHT RADIUS</b>	5.9"
<b>GRIP WIDTH</b>	1.4"
<b>WEIGHT UNLOADED</b>	28.6 OZ
<b>MAGAZINE CAPACITY</b>	9 AND 10 ROUNDS



# AMERICAN PISTOL SHOOTER

## PROJECT ALLEGIANCE



At Beretta, we know the dangerous nature of Law Enforcement. We understand the risks they face and the sacrifices they make. We also understand that officer deaths are increasing and in many communities across our nation these risks are unfortunately increasing at an alarming rate. Beretta has been working to deliver advanced, proven and reliable products and services that are designed to protect law enforcement officers and allow them to come home safely. We feel, however, the need to do more and this is why we launched Project Allegiance — a comprehensive effort to deliver new products, services and benefits that directly enhance the safety and well-being of law enforcement officers and their families.

The first benefit that Beretta will be launching under Project Allegiance is a three-year \$10,000 line-of-duty accidental

death benefit available to any law enforcement officer that purchases a Px4 Storm pistol. This line-of-duty-death benefit is offered at no cost to the officer or the agency and it includes other valuable services, like free bereavement, legal and financial counseling, designed to aid law enforcement families during their most critical time of need. No medical exam. No hassle. No questions asked. Project Allegiance will continue launching products and services in the future, to further enhance officer safety and well-being. But we need your help: by participating in this program, you ensure the success of Project Allegiance. Together we can extend these benefits to your fellow officers and work to strengthen the law enforcement community. For more information, visit your Beretta Law Enforcement dealer, or go to **ProjectAllegiance.com**.



Visit us at [BerettaLE.com](http://BerettaLE.com)

# AMERICAN PISTOL SHOOTER



## 92FS J92F300M

From the jungle heat of Panama to the sandstorms of Iraq, the U.S. Armed Forces have counted on Beretta pistols for almost two decades of distinguished service. The 92FS, Beretta's premier full metal gun, most resembles the military M9 9mm pistol. Accurate out of the box, this workhorse features an open slide design that virtually eliminates jamming, a safety system that combines decocking with a positive thumb safety, and a combat muzzle crown. Beretta's proprietary black, non-glare Bruniton finish gives your 92FS a wear-resistant coating, which means it will stand up to any special duty.

	92FS
<b>CALIBER</b>	9MM
<b>ACTION</b>	DOUBLE AND SINGLE
<b>OVERALL LENGTH</b>	8.5"
<b>OVERALL HEIGHT</b>	5.4"
<b>BARREL LENGTH</b>	4.9"
<b>SIGHT RADIUS</b>	6.1"
<b>GRIP WIDTH</b>	1.3"
<b>WEIGHT UNLOADED</b>	34.4 OZ.
<b>MAGAZINE CAPACITY</b>	10 AND 15 ROUNDS

*"I was on a recovery mission last year in the Sadr City district of Baghdad trying to recover an M1A1 tank that was hit by insurgents. In the process of conducting the mission, my tank commander was injured, leaving me in command of my tank. With no support on my flanks, I was pretty exposed. A group of Iraqis began to converge on my tank, gesturing for an RPG team. With no room to traverse my turret, I stood up in my hatch and suppressed the group by dispersing them with my M-9. If they had gotten that shot off at my flank, I may not be here today. Thanks, Beretta, for a great product and supporting my platoon."*

— Staff Sergeant Michael Blake, U.S. Army

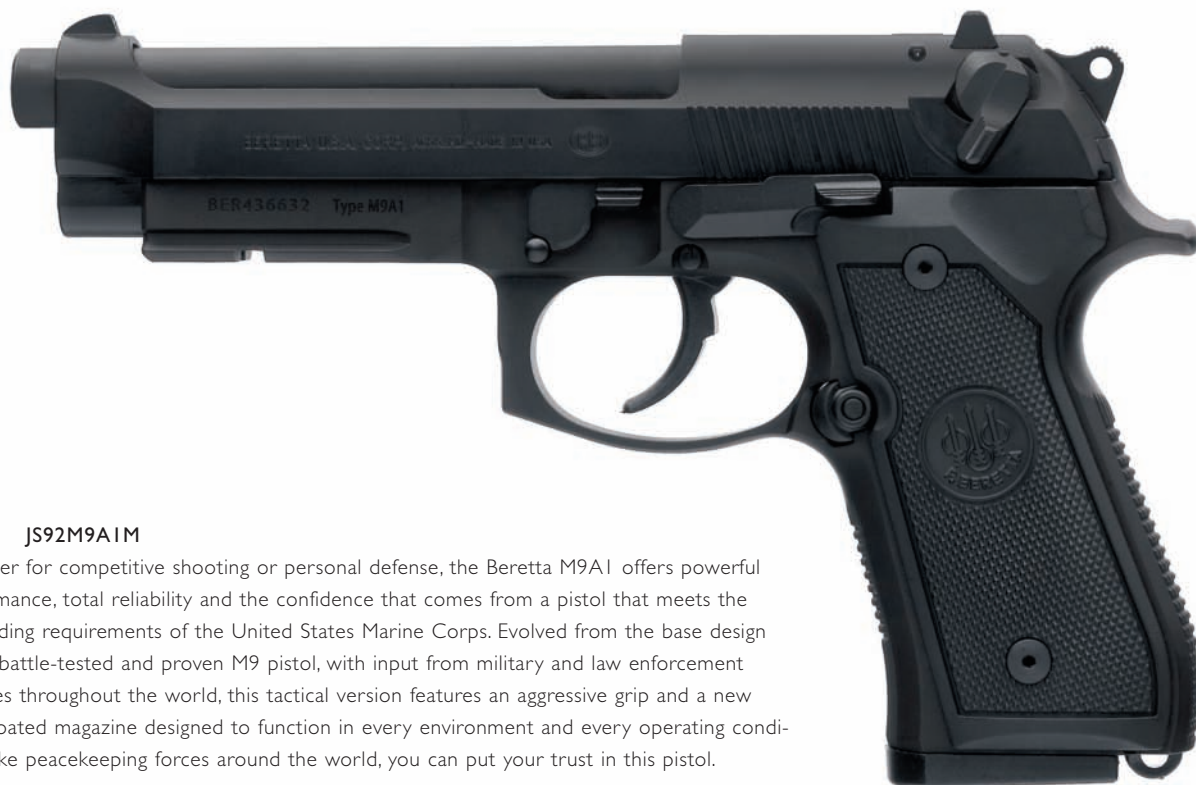

**M9A1 JS92M9AIM**

Whether for competitive shooting or personal defense, the Beretta M9A1 offers powerful performance, total reliability and the confidence that comes from a pistol that meets the demanding requirements of the United States Marine Corps. Evolved from the base design of the battle-tested and proven M9 pistol, with input from military and law enforcement agencies throughout the world, this tactical version features an aggressive grip and a new PVD-coated magazine designed to function in every environment and every operating condition. Like peacekeeping forces around the world, you can put your trust in this pistol.

**M9A1 SAND-RESISTANT  
MAGAZINE  
JM9A115**



**M9A1**

<b>CALIBER</b>	9MM
<b>ACTION</b>	DOUBLE AND SINGLE
<b>OVERALL LENGTH</b>	8.5"
<b>OVERALL HEIGHT</b>	5.5"
<b>BARREL LENGTH</b>	4.9"
<b>SIGHT RADIUS</b>	6.1"
<b>GRIP WIDTH</b>	1.31"
<b>WEIGHT UNLOADED</b>	34.9 OZ.
<b>MAGAZINE CAPACITY</b>	10 AND 15 ROUNDS



The M9 has successfully served America's armed forces on far-flung battlefronts throughout the world—from the chaos of Mogadishu to the deserts of Iraq and the fire-swept streets of Baghdad. Countless soldiers, sailors, airmen and marines have stood guard to preserve the nation's freedom, protected by its accuracy and firepower. Beretta is honored to manufacture the M9, the standard sidearm for the U.S. Armed Forces, and its civilian counterpart, the 92FS—the most reliable and safest semiautomatic pistols ever made.

# AMERICAN PISTOL SHOOTER



90-TWO	
<b>CALIBER</b>	90MM & .40
<b>ACTION</b>	DOUBLE AND SINGLE
<b>OVERALL LENGTH</b>	8.5"
<b>BARREL LENGTH</b>	4.9"
<b>OVERALL WIDTH</b>	1.5"
<b>WIDTH AT SAFETY LEVER</b>	1.4"
<b>GRIP WIDTH (STANDARD)</b>	1.32"
<b>GRIP WIDTH (SLIM)</b>	1.26"
<b>OVERALL HEIGHT</b>	5.5"
<b>SIGHT RADIUS</b>	6.4"
<b>WEIGHT UNLOADED</b>	32.5 OZ.
<b>MAGAZINE CAPACITY (9mm)</b>	10 AND 17 ROUNDS
<b>MAGAZINE CAPACITY (.40)</b>	10 AND 12 ROUNDS

## 90-TWO J9T9F11

The 90-Two has the great features of our 90 series pistols such as reversible magazine release button, ambidextrous safety, open slide design (which virtually eliminates jamming or stove-piping), loaded chamber indicator, visible firing pin block, and super accuracy.

Here are the new features: one-piece wrap-around grips in configurations for different size hands; automatic disassembly latch that locks when slide is replaced; internal recoil buffer, which decreases received stress and increases service life; additional slide serrations for better grip; captive recoil spring; removable front sight; 17-round magazine (9mm); and, like the USMC's M9A1, it features an integrated Picatinny rail. The 90-Two is available in 9mm and .40 caliber.



The new removable single-piece, ergonomic and modular grip unit allows for quick and easy grip replacement. The rear upper part is precisely curved and relieved for a firmer, more comfortable grip and to snugly fit the shooter's hand.



A Picatinny rail protection cover is included with each 90-Two.



90-Two with Burris Xtreme Tactical Laser Flashlight.

# AMERICAN PISTOL SHOOTER

## 84FS CHEETAH AND 87 TARGET



### 84FS CHEETAH NICKEL J84F212M

Back by popular demand, the nickel finish 84FS Cheetah Nickel with checkered walnut grips is light, fast handling and ideal for personal defense. Its .380 Auto caliber is just right for those who prefer the light recoil and report of a higher caliber, smaller pistol. Very accurate out of the box, its ambidextrous safety is easily accessible by the thumb for right- or left-handed shooters.

### 84FS CHEETAH NICKEL

<b>CALIBER</b>	.380 AUTO
<b>ACTION</b>	DOUBLE AND SINGLE
<b>OVERALL LENGTH</b>	6.8"
<b>OVERALL HEIGHT</b>	4.8"
<b>OVERALL WIDTH</b>	1.4"
<b>BARREL LENGTH</b>	3.8"
<b>SIGHT RADIUS</b>	4.9"
<b>WEIGHT UNLOADED</b>	23.3 OZ.
<b>MAGAZINE CAPACITY</b>	13/10 ROUNDS

### 87 TARGET

<b>CALIBER</b>	.22LR
<b>ACTION</b>	DOUBLE AND SINGLE
<b>OVERALL LENGTH</b>	8.9"
<b>OVERALL HEIGHT</b>	5.4"
<b>OVERALL WIDTH</b>	1.3"
<b>BARREL LENGTH</b>	5.9"
<b>SIGHT RADIUS</b>	7.3"
<b>WEIGHT UNLOADED</b>	40.9 OZ.
<b>MAGAZINE CAPACITY</b>	10 ROUNDS



### 87 TARGET J87T010

While the Cheetah is a lightweight pistol for field carry, the 87 Target is a heavyweight competition gun that will be at home on any range. It features both adjustable metallic sights and a Weaver-style rail for mounting scopes or red dot sights. A squared-off muzzle allows a steady ready position on the bench for practical or international standard pistol shooting. The single-action trigger is light and crisp for accurate off-hand firing.

### 87 TARGET GRIPS FOR LEFT-HANDED SHOOTER

EU00306



### 87 TARGET GRIPS FOR RIGHT-HANDED SHOOTER

EU00307

# AMERICAN PISTOL SHOOTER

## 21 BOBCAT AND 3032 TOMCAT

### BOBCAT WOOD GRIP

JG21W



### 21 BOBCAT J212104

When police officers or concealed carry permit holders look for the ultimate in concealability, they look to the Beretta Bobcat in .25 Auto and .22 Long Rifle. This double-action pistol may be tiny, but it's a reliable defensive arm. The tip-up barrel of this pocket pistol allows rounds to be loaded directly into the chamber without slide retraction. Precisely rifled for accuracy, the barrel is forged out of special high strength steel.

### 21 BOBCAT

<b>CALIBER</b>	.22LR, .25 AUTO
<b>ACTION</b>	DOUBLE AND SINGLE
<b>OVERALL LENGTH</b>	4.9"
<b>OVERALL HEIGHT</b>	3.7"
<b>OVERALL WIDTH</b>	1.1"
<b>BARREL LENGTH</b>	2.4"
<b>SIGHT RADIUS</b>	3.5"
<b>WEIGHT UNLOADED</b>	11.5 OZ.
<b>MAGAZINE CAPACITY</b>	7, 8 ROUNDS

### 3032 TOMCAT INOX

<b>CALIBER</b>	.32 AUTO
<b>ACTION</b>	DOUBLE AND SINGLE
<b>OVERALL LENGTH</b>	4.9"
<b>OVERALL HEIGHT</b>	3.7"
<b>OVERALL WIDTH</b>	1.1"
<b>BARREL LENGTH</b>	2.4"
<b>SIGHT RADIUS</b>	3.3"
<b>WEIGHT UNLOADED</b>	15.8 OZ.
<b>MAGAZINE CAPACITY</b>	7 ROUNDS

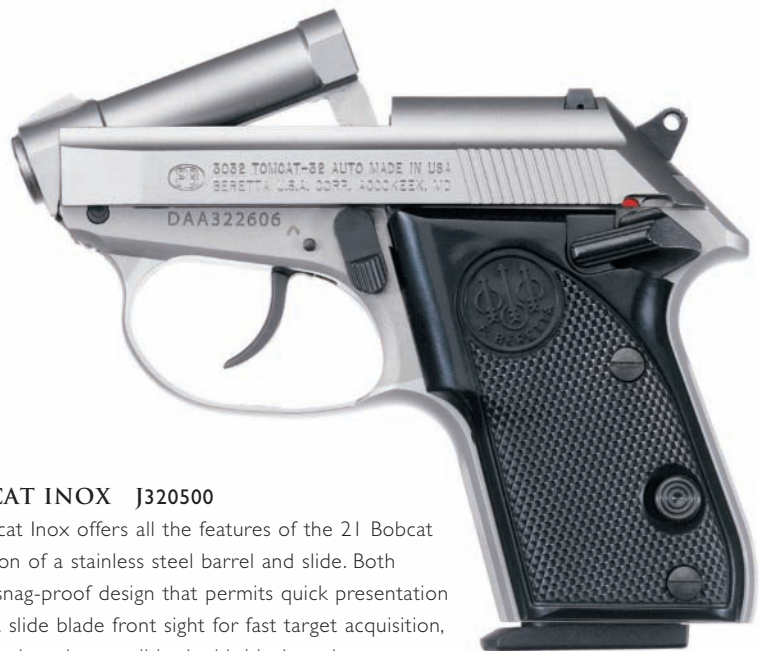

### 3032 TOMCAT INOX J320500

The 3032 Tomcat Inox offers all the features of the 21 Bobcat with the addition of a stainless steel barrel and slide. Both pistols have a snag-proof design that permits quick presentation to the target, a slide blade front sight for fast target acquisition, and a smooth, crisp trigger pull in double/single action.

(3032 also available in matte finish).



U22 NEOS AND U22 NEOS DELUXE



u22 neos

**U22 NEOS 4.5 JU2545B**

Designed and manufactured in America by Beretta USA, the new U22 Neos semiautomatic pistol is a single-action, .22LR caliber firearm. Designed for entry-level pistol shooters, it is ideal for training and plinking but can be adapted to the advanced shooter's needs. Despite being richly accessorized, the Neos is on the market at an affordable price. The pistol features cutting-edge design, modular construction that allows personalization, and the flexibility for many shooting disciplines. This is a pistol that won't easily be outgrown as skills improve.



U22 NEOS 6.0 INOX JU2560X

**ACCESSORY BARREL ASSEMBLY**

Choose from three barrel lengths, all fitted with accessory rails that accept Weaver-style rings.



**ACCESSORY SLIDE ASSEMBLY**

Choose a blued or inox slide.



**ACCESSORY REAR AND FRONT SIGHTS**

Select the right sight color for the Target: black, red, or white. Both front and rear sights are replaceable.



**U22 NEOS 4.5**

**U22 NEOS 6.0**

<b>CALIBER</b>	.22LR	.22LR
<b>ACTION</b>	SINGLE	
<b>OVERALL LENGTH</b>	8.8"	10.3"
<b>OVERALL HEIGHT</b>	5.2"	5.2"
<b>BARREL LENGTH</b>	4.5"	6.0"
<b>SIGHT RADIUS</b>	7.4"	8.9"
<b>GRIP WIDTH</b>	1.5"	1.5"
<b>WEIGHT UNLOADED</b>	31.7 OZ.	36.2 OZ.
<b>MAGAZINE CAPACITY</b>	10 ROUNDS	10 ROUNDS

**ACCESSORY GRIPS WITH RUBBER INLAYS**

Upgrade to the Deluxe-style grip frame with comfortable rubber inlays.



# AMERICAN PISTOL SHOOTER

## CX4 STORM



**CX4 Storm**



Right side view  
(Shown with P-Rail and optional  
tri-rail mount)

### CX4 STORM JX49210M

Accurate, easy to use, field strip and accessorize, the Cx4 Storm fits every need of the American pistol shooter. Today's shooter demands a gun that can accept a large assortment of accessories, and the Cx4 caters to all tastes. A retractable accessory rail extends from the fore-end for mounting tactical lights. Rails can be installed on either side or the bottom of the fore-end for lasers or forward grips and all new Cx4 Storm Carbines come with a full P-Rail on the top of the receiver (shown in right side view photo). Redefining the pistol-caliber carbine, with racy and radical lines from the masters of industrial design at Giugiaro. The Cx4 Storm's smooth, sweeping curves are made possible by the use of modern high-strength, lightweight technopolymers.

Retractable fore-end rail for  
mounting of optional tactical  
lights and laser units.



### PRO SERIES STORM CASE

JA130A



### CX4 STORM

<b>CALIBER</b>	9MM, .40 S&W, .45 ACP
<b>ACTION</b>	SINGLE ACTION
<b>STOCK</b>	SYNTHETIC
<b>RECOIL PAD</b>	RUBBER
<b>SAFETY</b>	CROSS-BOLT, REVERSIBLE
<b>OVERALL LENGTH</b>	29.7" *
<b>BARREL LENGTH</b>	16.6"
<b>LENGTH OF PULL</b>	13 1/4" - 15" **
<b>WEIGHT UNLOADED</b>	5 3/4"
<b>REAR SIGHT</b>	GHOST RING WITH TWO SIZE APERTURES
<b>FRONT SIGHT</b>	POST, ADJUSTABLE FOR WINDAGE & ELEVATION
<b>SIGHT RADIUS</b>	12.9"
<b>MAGAZINE CAPACITY</b>	10, 15, 17, 20 (9MM)
<b>MAGAZINE CAPACITY</b>	10, 11, 14, 17 (.40 S&W)
<b>MAGAZINE CAPACITY</b>	8 (.45 ACP)

\*WITHOUT STOCK SPACERS INSTALLED. \*\*ADJUSTABLE WITH STOCK SPACERS.

PISTOL-CALIBER CARBINE



# AMERICAN PISTOL SHOOTER

## APPAREL AND ACCESSORIES



The same attention to detail and manufacturing excellence that Beretta reserves for its legendary pistols is given to the products that complement them. They are a natural extension of the Beretta lifestyle you have come to live and love through our firearms.

### SELECT LENS SHAPES



Shooter

Hunter

Performance



### SHOOTING GLASSES

SOC31003100

Featuring the finest polycarbonate lenses available and the highest quality ophthalmic components, these glasses will custom fit to your face. Frames feature spring hinges, adjustable nose bridge, temple tips, and nose pads. Shooter lenses (for maximum protection on the range) in three colors: yellow, clear, and smoke.

### SELECT FRAME



Gun Meal Grey



Matte Black



Antique Gold

### SELECT LENS COLOR



Smoke



Yellow



Clear



Purple



Orange



Red



### BIG B HAT

BC89919058 • ONE SIZE



PISTOL TOOL JK820A02



### AIRLIGHT II SILVER 3.75"

JK003A03

# AMERICAN PISTOL SHOOTER



Slashproof, snatchproof and tamperproof, eXomesh™ is a revolutionary interlocking security system, built into all Beretta Security Packs, enabling you to secure your firearm when traveling. Designed to look like ordinary luggage, they disappear into the background allowing you to travel with your firearm discretely. Portable and compact, they lock securely around a steering wheel, hotel room fixture, or any permanent fixture.



**NRA SECURITY PACK**  
SCC2056NRA



**PISTOL SECURITY PACK**  
SCC2056



**RIFLE SECURITY PACK**  
SCC2057



**TRIDENT PISTOL RUG**  
JA100A08





INTRODUCING  
WESTERN SHOOTER

The cowboy mystique lives on. From the prairies of Nebraska to the deserts of New Mexico, it runs through the veins of those who treasure tradition and revel in glories past. The spin of the cylinder, the glint of the nickel barrel, the sheer thrill of breaking open a six-shooter or the adrenaline rush of firing a fast handling, lever-action rifle. There's nothing that quite compares to that exhilaration. But more than anywhere else, the heritage of the Old West runs deep in the heart of the Western Shooter. And finds its fulfillment in that moment when you test yourself, using those classic firearms that defined a fabled era, against the legends of the American frontier.

Authenticity and performance is what matters above everything else to the Western Shooter. This is why you'll find an extraordinary combination of both in Beretta's lineup of Old West firearms. These fine firearms are for the Western Shooter who demands absolute truthfulness to the 19th century originals as far as dimensions, feel and functioning, coupled with Beretta-style reliability, safety and performance.

# WESTERN SHOOTER



## STAMPEDE FAMILY

### STAMPEDE OLD WEST JEJ1401

It is hard to think about the American Old West without mentioning the Colt Single Action Army revolver, as it has become the icon for all the romance and adventure of the Old West. Often called the “Peacemaker”®, the Single Action Army revolver was the sidearm of choice for legendary figures like Wyatt Earp, Doc Holliday, Bat Masterson, Teddy Roosevelt and notorious outlaws including the Daltons, Billy the Kid and Black Bart.

Today, the legend of the American Old West lives on through the Beretta Stampede Single Action revolver. From the multiple clicks of the hammer to the feel of the grip, the Stampede is true in every detail, bridging Old West authenticity with Beretta’s reliability, safety and performance.



STAMPEDE OLD WEST



Now available in .357 Magnum

STAMPEDE MARSHALL OLD WEST



### STAMPEDE, OLD WEST & OLD WEST MARSHALL

The Stampede, in Beretta’s Old West finish is reminiscent of today’s most sought-after collector pieces. But make no mistake, Beretta’s new Old West finish is as tough and corrosion resistant as any modern firearm. Although they make great collector pieces, these bad boys were born to shoot — perfect for cowboy action shooting, target shooting and close-range hunting.

STAMPEDE MARSHALL



### STAMPEDE MARSHALL JEE1401

The internal features may be the same as Beretta’s other single-action Stampedes, but the walnut birdhead grip gives the Marshall a distinction all its own. Chambered in .45 Colt and .357 Mag, this handsome replica incorporates the most modern safety features. The feel and functioning are just like the originals, with a multiple-click single-action hammer mechanism and a half-cock position that allows the cylinder to spin free.

#### STAMPEDE OLD WEST

<b>CALIBER</b>	.45 COLT, .357 MAG
<b>OVERALL LENGTH</b>	9 1/2", 11"
<b>BARREL LENGTH</b>	4 3/4", 5 1/2"
<b>GRIPS</b>	WALNUT
<b>CAPACITY</b>	6 ROUNDS
<b>FINISH</b>	OLD WEST

#### STAMPEDE MARSHALL

<b>CALIBER</b>	.45 COLT, .357 MAG
<b>OVERALL LENGTH</b>	8 1/4"
<b>BARREL LENGTH</b>	3 1/2"
<b>GRIPS</b>	WALNUT
<b>CAPACITY</b>	6 ROUNDS
<b>FINISH</b>	BLUE, BERETTA COLOR-CASE, AND OLD WEST



STAMPEDE FAMILY



**STAMPEDE NICKEL JEB1401**

There's no gun more quintessentially American than the single-action revolver. The Beretta Stampede combines the feel and handling qualities of the original "hogleg" with a transfer-bar safety system that makes it safe to carry with all six chambers loaded. The beauty is in the accurate details. The fixed front sight is true to the original. And with the frame dimensions closely matched to the 19th-century originals, the Stampede feels slender and very responsive in the hand.



"I started shooting with a competitor's six gun. I had a hard time keeping the same sight picture every time I drew it from my holster. So I turned it in and bought two Beretta Stampedes. They were dead accurate right out of the box. The grips were thin and fit better in my hands. I have not had any problems wLth them and they look great. I love shooting them."

— Beretta Customer

**STAMPEDE NICKEL**

<b>CALIBER</b>	.45 COLT, .357 MAG
<b>OVERALL LENGTH</b>	9 1/2", 11", 13"
<b>BARREL LENGTH</b>	4 3/4", 5 1/2", 7 1/2"
<b>GRIPS</b>	WALNUT
<b>CAPACITY</b>	6 ROUNDS
<b>FINISH</b>	POLISHED NICKEL

**STAMPEDE DELUXE**

<b>CALIBER</b>	.45 COLT, .357 MAG
<b>OVERALL LENGTH</b>	9 1/2", 11", 13"
<b>BARREL LENGTH</b>	4 3/4", 5 1/2", 7 1/2"
<b>GRIPS</b>	SELECT WALNUT
<b>CAPACITY</b>	6 ROUNDS
<b>FINISH</b>	CHARCOAL BLUE, BERETTA COLOR-CASE



**STAMPEDE DELUXE JEC1401**

The Stampede Deluxe features a frame finished in Beretta Color-Case, which duplicates the classic look of color-casehardening to capture the romance of the Old West. Select walnut grips and a lustrous charcoal-blued barrel and cylinder complete the picture. Whatever your choice, the transfer-bar safety system will allow you to safely load all six chambers without fearing an accidental discharge.



# WESTERN SHOOTER

## STAMPEDE FAMILY



STAMPEDE PHILADELPHIA  
CUSTOM ENGRAVED MATCHED PAIR  
JEG3501B

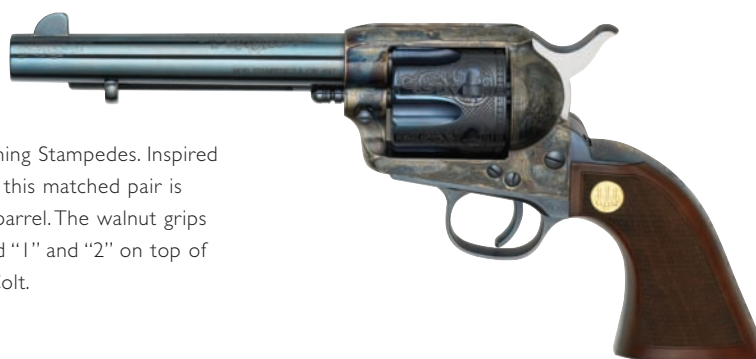
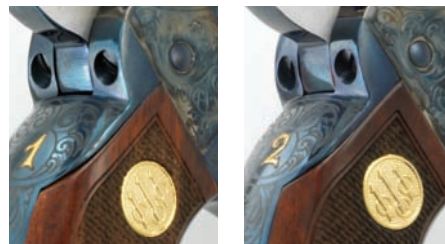

Any cowboy would be proud to fill his holster with these matching Stampedes. Inspired by the limited edition Philadelphia Centennial engraving (1876), this matched pair is laser-engraved then hand-finished on the receiver cylinder and barrel. The walnut grips feature checkering and inlaid gold Beretta medallions. Gold-filled "1" and "2" on top of backstrap; paired serial numbers; 5½-inch barrels. Caliber: .45 Colt.



STAMPEDE GEMINI, MATCHED PAIR  
JEG4501R



This handsome matching pair of Stampedes features German silver trigger guards and backstraps. The wood grips are hand-rubbed, oil finished and fitted with a gold Beretta medallion. In addition to matching paired serial numbers, Beretta has stamped the "UGB" inspector cartouche on the outside panel of each grip. These stamps match the side of the serial number prefix. 5½-inch barrels. Caliber: .45 Colt.

STAMPEDE FAMILY



STAMPEDE BISLEY JEF1401

Old West firearm connoisseurs will be pleased by how true to the original this replica looks and feels, although it incorporates a transfer-bar safety and is manufactured of durable modern materials. Instead of taking the easy road and “dressing up” this Stampede as a Bisley, Beretta built this revolver from the ground up around a true Bisley frame — which is somewhat taller than that on its standard single-action cousin. The distinctive Bisley grips in imitation Bakelite, hammer and wide trigger are also a precise replica of the originals as far as dimensions, balance and feel.

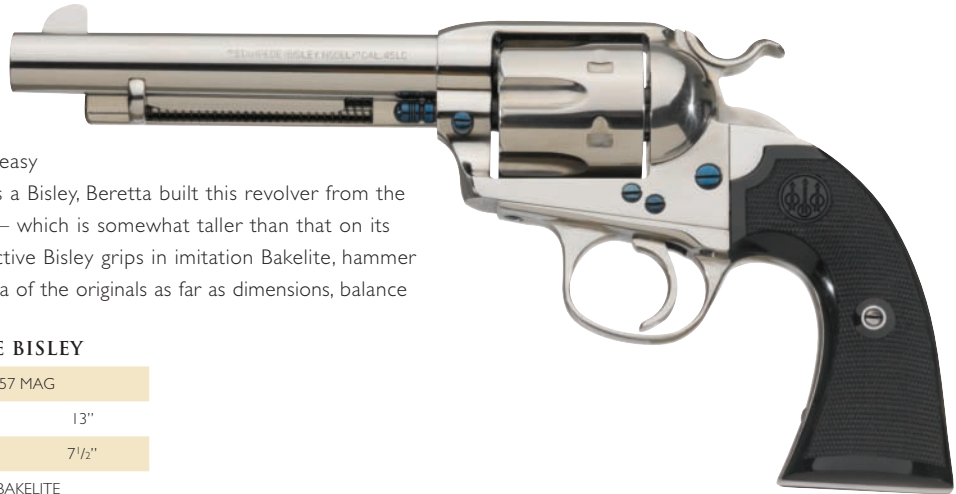

STAMPEDE BISLEY

<b>CALIBER</b>	.45 COLT, 357 MAG		
<b>OVERALL LENGTH</b>	9 1/2"	11"	13"
<b>BARREL LENGTH</b>	4 3/4"	5 1/2"	7 1/2"
<b>GRIPS</b>	IMITATION BAKELITE		
<b>CAPACITY</b>	6 ROUNDS		
<b>FINISH</b>	NICKEL OR BLUED		

LARAMIE



LARAMIE

JFA1501

The Laramie is the finest replica ever made of the Smith & Wesson Model 3 break-open revolver which became famous in the old west for its quality, accuracy, and speed at which it could be loaded and unloaded. Upon releasing the top latch located in front of the hammer, the revolver could be instantly unloaded by “breaking it open,” thus allowing all six empty shells to fly out of the cylinder. Beretta has improved upon the 19th-century original by reinforcing the top latch, thus making the revolver much more durable and ensuring you years and years of trouble-free enjoyment.



An accurate reproduction, we made the Laramie considerably safer by designing a rebounding-hammer/hammer-block system that allows you to safely carry it with all six chambers loaded.

LARAMIE

<b>CALIBER</b>	.45 COLT, 38 SP	
<b>OVERALL LENGTH</b>	10.6"	12.2"
<b>BARREL LENGTH</b>	5"	6 1/2"
<b>CAPACITY</b>	6 ROUNDS	
<b>FINISH</b>	NICKEL OR BLUED	
<b>GRIP</b>	WALNUT	

# WESTERN SHOOTER

## 1873 RENEGADE SHORT RIFLE



### 1873 RENEGADE

<b>CALIBER</b>	.45 COLT, 357 MAG
<b>BARREL LENGTH</b>	20"
<b>CAPACITY</b>	10 ROUNDS
<b>FINISH</b>	BLUED

### BERETTA 1873 RENEGADE SHORT RIFLE JNA1A01

In 1873, Oliver Winchester introduced his new steel-framed lever-action rifle, creating what would eventually be known as the "Gun That Won the West." The Model 1873 was originally chambered in a new, more powerful cartridge, the .44/40—a .44 caliber bullet propelled by 40 grains of black powder. However, one big factor that really ensured the success of the 1873 was that Colt quickly responded by offering its frontier six-shooter chambered in .44/40. A cowboy could have both a lever-action rifle and his "Peacemaker" and need only one cartridge belt. Today, the 1873 is the most popular rifle used in cowboy action shooting. **Beretta's new 1873 Renegade takes this popular design to the next level as the first factory-produced 1873 rifle with a shorter action stroke length, straight butt plate and gold bead front sight—"race ready" right out of the box!** Available in .45 colt and .357 Mag.



## STAMPEDE BUNTLINE



### STAMPEDE BUNTLINE

<b>CALIBER</b>	.45 COLT
<b>BARREL LENGTH</b>	18"
<b>CAPACITY</b>	10 ROUNDS
<b>FINISH</b>	BLUED

### STAMPEDE, BUNTLINE CARBINE (BLUED) JEH1801

In 1873, it is said that dime novelist Ned Buntline presented Colt revolvers with shoulder stocks to the most famous men of the Old West, including lawmen Wyatt Earp and Bat Masterson. The Buntline revolver was one of the first reliable repeating rifles, battle-tested in the Mexican War as well as Indian Wars of the Southwest.

The new Beretta Stampede Buntline revolver is a true working replica of the famous Buntline, featuring the same great performance and reliability as Beretta Stampede revolvers, including the innovative transfer bar safety, which allows the revolver to be safely loaded with six cartridges rather than five and an open chamber. Hooked trigger guard, 18-inch barrel, brass crescent butt plate, checkered stock, inlaid gold Beretta medallion on both sides.

GOLD RUSH/GOLD RUSH DELUXE



**GOLD RUSH RIFLE JHA1B01**

The Beretta Gold Rush Rifle follows the same philosophy as our successful Stampede revolver: combining the looks and feel of the Old West original with modern safety and reliability. Chambered for the .45 Colt and the .357 Mag/38 Special, the Gold Rush is a fast-handling pump-action longarm perfect for Cowboy Action Shooting, small-game hunting and informal target practice. Discrete modifications have been incorporated that greatly enhance safety and reliability.



**GOLD RUSH CARBINE JHA1A01**

Like the Gold Rush Rifle, the Gold Rush Carbine is a testament to authenticity coupled with modern performance. Compared to the original, several enhancements have been made. A solid transfer-bar safety mechanism is housed in the hammer, making the gun absolutely safe to load and unload without having to lower the hammer. Feeding is improved considerably by ensuring that each cartridge is perfectly in line with the chamber. And a redesigned cycling mechanism makes it possible to obtain the desired speeds without jams.



**GOLD RUSH DELUXE JHB1B01**

The Beretta Gold Rush Deluxe Rifle and Carbine exemplify the same high standards in engineering and performance as the Beretta Gold Rush and Carbine, with some important aesthetic differences. Features of the Gold Rush Deluxe include charcoal-blued barrels, jeweled hammer and trigger and German silver medallion inlaid into the stock. The Deluxe walnut stock and fore-end have special fish-scale checkering, oil finish and Beretta "three-arrow" logo engraved in the checkering pattern.

**GOLD RUSH RIFLE**

**GOLD RUSH CARBINE**

**GOLD RUSH DELUXE RIFLE**

**GOLD RUSH DELUXE CARBINE**

<b>CALIBER</b>	.45 COLT, .357 MAG		.45 COLT	
<b>BARREL LENGTH</b>	24 1/4"	20"	24 1/4"	20"
<b>CAPACITY</b>	13 ROUNDS	10 ROUNDS	13 ROUNDS	15 ROUNDS
<b>FINISH</b>	BLUE/BERETTA COLOR-CASE		CHARCOAL BLUE, BERETTA COLOR-CASE	





INTRODUCING  
THE 1526 COLLECTION

The sheer beauty is in every luxurious detail. From the rich baroque spirals hand chiseled by Master Engravers to the extraordinary cut of cloth and harmonious stitching found in the world's finest Italian apparel. Here there are no compromises; here only the very best will do. Every shotgun is created of hand-selected wood, hand engraved and hand fitted. Every article of clothing is fashioned from only the finest fabric in impeccable Italian design.

The 1526 Client is the collection that defines Beretta. That represents living at its very best. Not only is this the collection that the Beretta family is most hands-on involved with, this is the lifestyle the Berettas themselves live. This is their legacy; this is their passion. There is, quite simply, no finer example of Beretta's heritage of unflagging dedication to extraordinary performance and outstanding quality than in this collection, which is enveloped in the Italian sense of craftsmanship and style unrivaled worldwide.

# THE 1526 COLLECTION



## SO10 EELL

Seventy years after the first modern Beretta over-and-under (the S1 launched in 1933), a new true sidelock shotgun is born: the SO10 EELL over-and-under. It is the deserving successor of the famous Beretta SO series hunting and competition shotguns that have earned their reputation, on the Olympic podium and on the most exclusive hunts in the world, from Europe to America to Africa, for being the most functional, elegant and exclusive over-and-under in the world. Drawing from this very long experience, and under the dedicated guidance of the Beretta family, the most gifted designers and gunsmiths of the company have created the new SO10 EELL, a synthesis of aesthetic refinement, function and performance that place it at the peak of the world's prestigious over-and-under offerings.



In Italian, EL stands for *extra lusso* (extra luxury). The prized double "E" double "L" designation takes that quality to the highest level of luxury.

Master Engraver Mario Terzi.



## ELEGANCE AND CARE

Entirely hand executed by expert craftsmen, the Beretta SO10 EELL over-and-under case is made of solid wood covered in resistant leather. A full range of handmade cleaning and maintenance accessories is provided. Type and color of leather, wood, finishing and accessories vary depending on the model.

## SO10 EELL, SO10

<b>ACTION</b>	LOW PROFILE, TRUE SIDELOCK, HAND ENGRAVED
<b>GAUGE</b>	12, 20, 28
<b>CHAMBER</b>	76 MM / 3" (28 GAUGE 70 MM / 2¾")
<b>BARREL LENGTH</b>	67 CM / 26"; 71 CM / 28"; 76 CM / 30"
<b>CHOKES</b>	FIXED CHOKES OR OPTIMACHOKE®
<b>STOCK/FORE-END</b>	CUSTOM MADE WITH THE HIGHEST QUALITY WALNUT, HAND CHECKERED
<b>WEIGHT</b>	2,700 KG / 6,0 LBS (20 GAUGE); 2,500 KG / 5,5 LBS (28 GAUGE)

WEIGHTS ARE APPROXIMATE, DEPENDENT ON WOOD DENSITY AND BARREL LENGTH.



IMPERIALE MONTECARLO



**IMPERIALE MONTECARLO**

A shining example of what can be achieved when free reign is given to Master Gunsmiths in the crafting of personalized luxurious shotguns and when Master Engravers are able to express their artistry in full, the Imperiale Montecarlo is a masterpiece destined to become a part of gunmaking history. The deeply blued Demibloc barrels of the Imperiale Montecarlo side-by-side boast numerous, exclusive qualities that have determined its fame as a great hunting and competition gun. They begin with the special steel that assures extremely high resistance and outstanding tensile strength and conclude with the exclusive cold bluing of the barrels that give them an extraordinary deep glossy black color. The final result will astonish even the most refined connoisseur.



**THE ART OF ENGRAVING**

English scrollwork, hunting scenes, floral motifs, deep relief, mixed technique engravings, portraits and more. Any type of engraving is possible on an Imperiale Montecarlo and is executed only by the most expert Master Engravers.



**IMPERIALE MONTECARLO**

<b>ACTION</b>	COMPACT RECEIVER, TRUE SIDELOCK, HAND ENGRAVED
<b>GAUGE</b>	12, 20, 28
<b>CHAMBER</b>	70 MM / 2 3/4"; 76 MM / 3" ON REQUEST
<b>BARREL LENGTH</b>	66 CM / 26"; 68 CM / 27"; 71 CM / 28" OR WATHEVER LENGTH ON REQUEST
<b>CHOKES</b>	FIXED CHOKES
<b>STOCK/FORE-END</b>	CUSTOM MADE WITH THE HIGHEST QUALITY WALNUT, HAND CHECKERED
<b>WEIGHT</b>	3.300 KG / 7.3 LBS (12 GAUGE); 2.950 KG / 6.5 LBS (20 GAUGE); 2.800 KG / 6.2 LBS (28 GAUGE)

WEIGHTS ARE APPROXIMATE, DEPENDENT ON WOOD DENSITY AND BARREL LENGTH.

# THE 1526 COLLECTION



## SO6 EELL, SO5



### SO6 EELL

Embellished with the finest hand engraving proudly signed by the author, the SO6 EELL Premium Grade sidelock shotgun is sought after by connoisseurs who desire to be one of the few to own such a masterpiece. Pick one up and you know it is special—each of its elegant details, from the sophisticated engravings to the gold-inlaid animals to the dimensions of the walnut briar stock and receiver, is executed to suit the personal tastes and requirements of its owner. The Master Gunsmiths' handwork is evident everywhere, from the hand-cut deep diamond checkering to the hand-file cut ventilated rib. Prized for their beauty and uniqueness, each SO6 EELL is built to perform to the highest standards decade after decade, generation after generation.



### SO5

With numerous gold medals in the Olympics and other prestigious international competitions, the best shooters in the world consider the SO5 over-and-under the finest competition shotgun ever made. The SO5 is handcrafted to meet the requirements of every shooting discipline and can be further personalized for peak performance. This elegant champion's sleek profile enhances swing and pointability. Its sideplates are beautifully hand engraved and the trigger plate is embellished with a 24-carat fine gold inlay of the "P. Beretta" signature on the coin silver finish.



### SO6 EELL, SO5 TRAP, SKEET, SPORTING

<b>ACTION</b>	LOW PROFILE, TRUE SIDELOCK, HAND ENGRAVED
<b>GAUGE</b>	12
<b>CHAMBER</b>	70 MM / 2¾" OR 76 MM / 3"
<b>BARREL LENGTH</b>	67 CM / 26"; 71 CM / 28"; 76 CM / 30"; 81 CM / 32"
<b>CHOKES</b>	FIXED CHOKES OR MOBILCHOKE®; OPTIMACHOKE® (SPORTING)
<b>STOCK/FORE-END</b>	CUSTOM MADE WITH THE HIGHEST QUALITY WAL- NUT, HAND CHECKERED
<b>WEIGHT</b>	3.300 KG / 7.3 LBS (SO6); 3.700 KG / 8.1 LBS (TRAP); 3.400 KG (SKEET, SPORTING)

WEIGHTS ARE APPROXIMATE, DEPENDENT ON WOOD DENSITY AND BARREL LENGTH.



DT10 TRIDENT EELL, L



**DT10 TRIDENT EELL**

Competitors feel a special admiration for the shotgun that accompanies them to the podium. Since the beginning of international competition, Beretta has accompanied more medalists than any other brand of shotgun. The DT10 Trident EELL over-and-under was developed for discerning shooters, rolling performance and elegance into a truly durable, secure investment. The perfectly coupled components and the elegant, fully engraved, hand-finished receiver put this shotgun into the exclusive category of a Beretta Premium Grade.



English scroll or game scenes engraving extends to the side plates in this premium grade competition overunder.

**DT10 TRIDENT EELL AND L TRAP, DOUBLE TRAP, X TRAP, SKEET, SPORTING, ELECTROCIBLES**

<b>ACTION</b>	LOW PROFILE, BOXLOCK, HAND ENGRAVED ENGLISH SCROLLS OR FLORAL MOTIFS WITH GAME SCENES
<b>GAUGE</b>	12
<b>CHAMBER</b>	2¾" OR 3"
<b>BARREL LENGTH</b>	28"; 30"; 32"
<b>CHOKES</b>	FIXED CHOKES OR OPTIMACHOKE® (DOUBLE TRAP, X TRAP, SPORTING, ELECTROCIBLES)
<b>STOCK/FORE-END</b>	ON REQUEST, CUSTOM MADE, HAND CHECKERED
<b>WEIGHT</b>	8.1 LBS (TRAP, DOUBLE TRAP, SKEET, ELECTROCIBLES); 8.4 LBS (SPORTING); 9 LBS (X TRAP)

WEIGHTS ARE APPROXIMATE, DEPENDENT ON WOOD DENSITY AND BARREL LENGTH.

# THE 1526 COLLECTION



## GIUBILEO SERIES, 687 EELL CLASSIC



### GIUBILEO

The splendid Giubileo over-and-under, made in 12, 20, 28 and .410-gauge models, is distinguished by rich, baroque spiral and floral engravings on the receiver and sideplates, and by its exquisitely proportioned construction. There are no screws on the plates, allowing the Master Engravers to express their artistry in full, while the internal surfaces and mechanisms are impeccably polished. The elongated trigger guard, the safety and top lever are also completely engraved. The stock and fore-end, made from the highest quality walnut, are finely checkered.



### 687 EELL CLASSIC

Refined pleasures are the rewards of life. One of these rewards is hunting with a prestigious Beretta shotgun like the incomparable 687 EELL Classic. The full side plates boast a fine engraving with birds and are enhanced by intricately detailed ornamental motifs of branches, leaves and flowers which extend to the trigger plate, trigger guard and fore-end iron lever.

	GIUBILEO	687 EELL CLASSIC
<b>ACTION</b>	LOW PROFILE IMPROVED BOX LOCK, OVER-AND-UNDER	LOW PROFILE IMPROVED BOX LOCK, OVER-AND-UNDER
<b>GAUGE</b>	12, 20, 28, .410	12, 20, 28
<b>CHAMBER</b>	3" (28 GAUGE 2¾")	
<b>BARREL LENGTH</b>	26"; 28"; 30" (12, 20 GAUGE)	
<b>CHOKES</b>	FIXED CHOKES OR MOBILCHOKE®. OPTIMACHOKE® (12 GAUGE ONLY)	FIXED CHOKES OR MOBILCHOKE®
<b>STOCK/FORE-END</b>	PISTOL GRIP OR ENGLISH STRAIGHT-HAND WITH SCHNABEL FORE-END	ENGLISH STRAIGHT-HAND WITH SLIM FORE-END OR PISTOL GRIP WITH BEAVERTAIL FORE-END
	HIGHLY SELECTED WALNUT, HAND FINISHED	
<b>WEIGHT</b>	7.1 LBS (12 GAUGE); 6.2 LBS (20 GAUGE); 5.5 LBS (28 AND .410 GAUGE)	7.1 LBS (12 GAUGE); 6.2 LBS (20 GAUGE); 5.5 LBS (28 GAUGE)

WEIGHTS ARE APPROXIMATE, DEPENDENT ON WOOD DENSITY AND BARREL LENGTH.



455 EXPRESS AND SSO6 EXPRESS

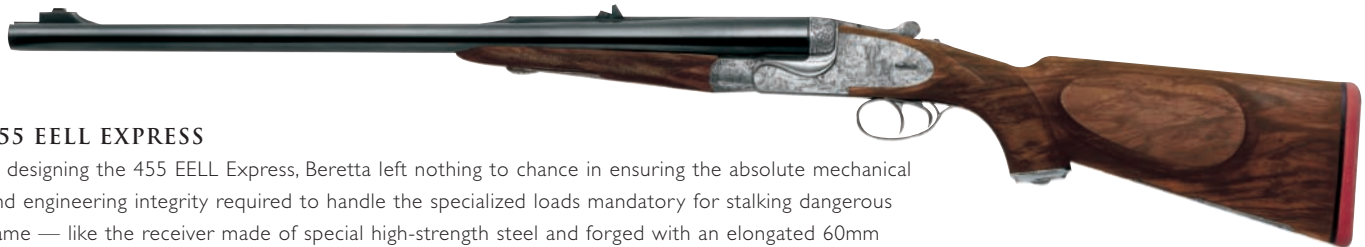

**455 EELL EXPRESS**

In designing the 455 EELL Express, Beretta left nothing to chance in ensuring the absolute mechanical and engineering integrity required to handle the specialized loads mandatory for stalking dangerous game — like the receiver made of special high-strength steel and forged with an elongated 60mm plate to compensate for stress when shooting. Or the reinforced receiver sides that can withstand the tremendous pressure of high-powered cartridges. With the highly detailed game scene engraving and intricate scrolling, this makes for one superbly finished rifle.



**SSO6 EELL EXPRESS**

For dedicated big game hunters worldwide, a Beretta SSO6 EELL Express rifle in the hand means a trophy on the wall. This is no ordinary firearm. The SSO6 Express EELL delivers a potent combination of ultra-strong receiver and carefully crafted barrels to comfortably handle today's powerful ballistics with remarkable accuracy. Hand-finished, hand-checked stocks and fore-ends from highly selected walnut and a color-casehardened receiver sporting 24-carat gold inlaid animals add masterful touches to this magnificent rifle. Hand engraved hunting scenes, on request.

	455 EELL	SSO6 EELL
<b>ACTION</b>	SIDE-BY-SIDE WITH TRUE SIDELOCKS, HAND ENGRAVED	OVER-AND-UNDER WITH TRUE SIDELOCKS, HAND ENGRAVED
<b>CALIBER</b>	.375 H&H MAG., .416 RIGBY; .458 WIN MAG; .470 NE; 500 NE	9.3 X 74 R; .375 H&H MAG; .458 WIN MAG
<b>BARREL LENGTH</b>	60 CM / 23" OR 65 CM / 25"	62 CM / 24"
<b>STOCK/FORE-END</b>	CUSTOM MADE WITH THE HIGHEST QUALITY WALNUT, HAND CHECKERED. WITH CHEEK PIECE	
<b>WEIGHT</b>	5.000 KG / 11 LBS	5.000 KG / 11 LBS

WEIGHTS ARE APPROXIMATE. DEPENDENT ON WOOD DENSITY AND BARREL LENGTH.



# THE 1526 COLLECTION

## APPAREL & ACCESSORIES



### ELEGANT ITALIAN STYLE, LEGENDARY BERETTA QUALITY

Not all things are made equal in this world. For those who appreciate the finer things in life, who see the beauty and value in the craftsman's attention to the smallest, hidden details...genuine leather buttons and trim...handpicked English wool and luxurious soft cashmere...field-tested fashions that honor the long tradition of the hunt...to you, only the very finest will do.

For the same reasons you cherish the master artisan's touch on a hand-chiseled shotgun, you treasure the handiwork that goes into the authentic, sophisticated clothing that immeasurably increases the pleasures of your pursuits.

This is time-tested hunting apparel that meets those unrelenting standards. The 1526 Collection is an extension of Beretta's passion and commitment to authenticity, timeless appeal, tradition and legendary quality. Welcome to the best of the best, to a world of luxury and quality without equal.



#### LABRADOR JACKET\*

Our corduroy blazer in wonderful stretch cotton takes its cues from the sport of hunting. The bellows pockets are trimmed in wool flannel and it is outfitted with leather buttons, soft leather elbow patches and leather braided trim surrounding the "shooting" patch. Slimmer European fit.

\* Because fashions change on a seasonal basis this particular jacket may not be available. Contact a Gallery near you to find out about our latest renditions.



APPAREL & ACCESSORIES



A COLLECTION OF THE WORLD'S FINEST

As you travel the continents in search of the finest the world has to offer, you have come to understand that there is no substitute for those special qualities that embody what is truly extra lusso. Such quality, once found, is impossible to retreat from.

Every article has been fastidiously designed, thoroughly tested and found to be worthy of the Beretta family's personal stamp of approval. This is the world's finest—without compromise.



**ENGLISH WOOL  
TWEED COAT  
WITH BUTTON-OUT  
INSULATED LINING GUI26360**

The tweed is English wool at its softest, but everything else about this coat harkens back to all things Scottish. The button-out vest insulated with ultrathin Thermo<sup>®</sup> and the button-up collar will keep you plenty warm. In a nod to modernity, the vest has a special pocket for your cell phone. The bi-swing back, expandable front bellows pockets, won-

derfully supple leather elbow patches, and a slew of pockets inside and out make this the most functional and comfortable tweed you'll ever own.

# THE 1526 COLLECTION

## EXPERIENCE THE BERETTA GALLERY



To step into a Beretta Gallery is to step into a world rich in tradition and steeped in the sporting lifestyle. Each of these elegant international boutiques showcases the complete line of Beretta products, from custom firearms finished entirely by hand to beautifully designed clothing and accessories that embody the Beretta lifestyle.

From the hand-chiseled stone façade of New York's Madison Avenue Gallery to the impressively stocked gunroom of the Dallas Gallery to the refined and elegant rooms of the Milano, Paris and London Gallery, these are shopping places of distinction, inspiration and rich heritage.

In these sophisticated settings, expert staff stand ready to assist the discriminating sportsman and connoisseur select the ideal firearm, sportswear and hunting accessories to suit their taste, lifestyle and needs.

### NEW YORK

718 Madison Avenue  
New York, New York 10065  
(USA)  
Phone: +1 212 319 3235

### DALLAS

41 Highland Park Village  
Dallas, Texas 75205  
(USA)  
Phone: +1 214 559 9800

### BUENOS AIRES

Arenales 1654/56  
1061 Capital Federal, Buenos Aires  
(Argentina)  
Phone: +54 114 81 39258

### MILANO

Via Durini, 5  
20122, Milano  
(Italy)  
Phone: +39 02 76 02 83 25

### PARIS

57, Rue Pierre Charron  
75008, Paris  
(France)  
Phone: +33 (0) 1 56 88 59 59

### LONDON

36 St. James's Street  
London, SW1A 1JD  
(England)  
Phone: +44 (0) 207 408 4411





THE 1526 COLLECTION  
 EXPERIENCE THE  
 BERETTA GALLERY

THE 1526 COLLECTION



**SPECIALTY CLOTHING**

Explore Beretta's full line of clothing and accessories in the refined and elegant rooms of its Gallery stores. From classically inspired sport clothing to Italian-styled fashions to specialty clothing made just for the Gallery you will find a fit that is right for you.



**FIREARMS**

Beautiful, well-stocked gunrooms are a feature of Beretta Gallery stores. In them you will find our full line of firearms, from pistols to premium grade shotguns. Specialized staff are available to assist you in choosing your ideal custom firearm with personalized engraving.



**EXCEPTIONAL FURNISHINGS  
 ZEBRA CHAIR**

Available only by special order in our Gallery stores, this exotic wing chair is fashioned from authentic South African zebra fur including a full mane that wraps over the back. Finely crafted in every detail including brass nail upholstery and carved walnut ball feet.



**PREMIUM GUN ACCESSORIES  
 GUN MAINTENANCE CASE**

A full range of finely hand crafted cleaning and maintenance accessories, dedicated to the Beretta premium guns care, is exactly lodged in this solid wood case, tan leather covered and red velvet lined.



**GIFTS OF DISTINCTION  
 PICNIC SET**

A luxury picnic set for outdoor lovers who enjoy style at all times. Painstakingly made by Italian craftsmen, this exclusive leather case contains fine white porcelain cups and plates with gilded edges and stainless steel cutlery and accessories.

# THE 1526 COLLECTION



## GALLERY EXPEDITIONS

Peter Horn II is one of the brainchilds and the business manager of The Beretta Gallery Stores. If you want to get a true sense of hunting, listen to him talk about the smells of the jungle and the colours of Tanzania, his passion for hunting and guns, the challenges and the dangers, and the need to safeguard nature.

Eastern Europe is another one of Peter's favorite hunting grounds and runs high-end excursions four times a year. Choices of areas, food and staff are based on what even the most sophisticated hunter would expect. Peter will be pleased to provide details for anyone wishing to know more about Beretta Gallery Expeditions.

Contact him at [www.berettausa.com/gallery](http://www.berettausa.com/gallery)

or at:

Peter Horn  
Vice President Cougar Corporation  
Beretta Gallery Expeditions Hunt Manager  
718 Madison Avenue  
New York, NY 10065, U.S.A.  
(212) 319-3235





# THE 1526 COLLECTION



*At the core of Beretta is a passion.  
An understanding of the wild places.  
The high grass and the low marsh.  
Rain and sun. Man and dog.  
It's in our genes.  
And so, too, is it in our hearts.  
It's why we exist.  
And it's why we have endured for nearly 500 years.  
Because of one purpose. One passion.*





## COMMUNICATIONS OVERVIEW

Every year Beretta develops a comprehensive communication plan aimed at ensuring that the product displayed on the shelves is always backed up by powerful and effective marketing campaigns in print and television and radio, increasing consumer awareness and demand. Carefully selected multi-million dollar investments allow Beretta to be present whenever the consumer looks for information, be it reading, researching or simply entertaining himself or herself. Here and on the following pages are some examples of how Beretta presents itself through the communications campaign.

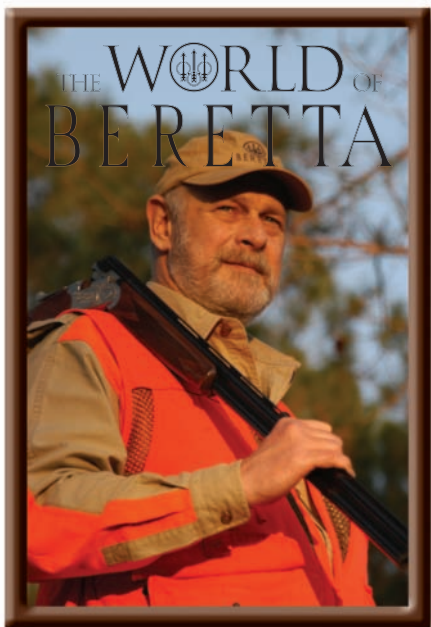

### TELEVISION SPONSORSHIPS

Beretta's television presence expands each year through the growth of the various networks on which it runs advertising, and also through the addition of new television sponsorships.

#### *THE WORLD OF BERETTA* ENTERS ITS 5TH SEASON

Hosted by Gerald McRaney each episode features exciting hunting expeditions spanning a rich and varied backdrop of destinations across America and around the globe.



Hosted by renowned whitetail hunter and author David Morris and comedian and deer hunter Jeff Foxworthy.



A new kind of reality series, this show will surprise a lucky contest winner and take him on the hunting or fishing trip of a lifetime.

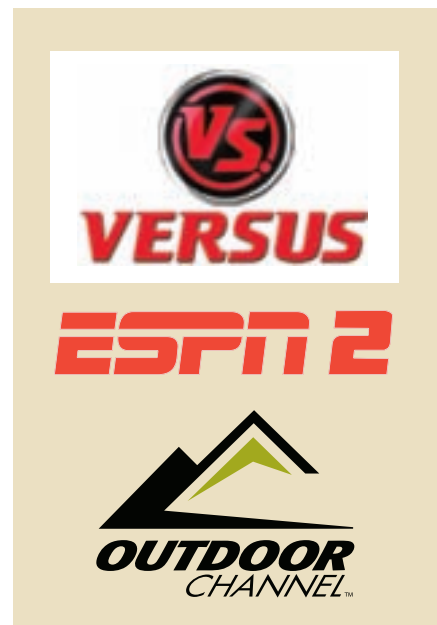

This groundbreaking series takes viewers along on hunts for the world's deadliest beasts.



Unparalleled sporting action found in some of the world's most memorable places.

### *Under Wild Skies*

Host Tony Makris takes extraordinary safaris to places like the Serengeti, the Okavango Delta and Ngorongoro Crater.



Showcasing some of the finest bird hunting locations and lodges around the world, hosted by Steve Smith and Christ Dorsey.

# COMMUNICATIONS OVERVIEW



## PRINT MEDIA — A MAINSTAY OF THE COMMUNICATIONS PLAN

Over the years Beretta has been present in literally hundreds of print publications. Today, Beretta maintains a print schedule that keeps the brand and its products in front of consumers during key seasons throughout the year.

Our ads are found in a wide range of industry publications reaching the hunting audience as well as the competitive shooter and handgun enthusiasts. More than 50 different magazines are typically on the media plan.

In addition to this endemic effort, Beretta has a limited presence in a select number of publications that expose the brand to consumers who have an appreciation for the outdoors, but are not necessarily participating in the shooting sports. These publications tend to be very targeted either in their readership or geographic coverage.

Beretta ads also appear in many event-specific publications associated with particular sports such as NASCAR, the NFL and the PGA.



# MEDIA



## COMMUNICATIONS OVERVIEW

### RADIO

Radio can be a powerful medium and is especially strong among men between the ages of 18 and 54. In fact more than 72% of all consumers listen to radio each day. This year Beretta has added a radio component to its communication plan.



Hosted by Tom Gresham, *Gun Talk Radio* is the only nationally syndicated radio talk show about firearms, shooting, personal safety and gun rights. The show is distributed through ABC Satellite radio stations, XM Satellite Network, live worldwide internet streaming, and on more than 50 stations across the country.



Dallas-Ft. Worth talk radio station K-SKY is where Beretta runs a weekly schedule of radio commercials promoting Beretta products and the brand throughout the year.

### BERETTA'S MAIL ORDER CATALOG

More than two million catalogs are mailed directly to the homes of Beretta customers each year, featuring our newest, our most popular, and our featured products. These catalogs not only increase top-of-mind awareness, but help us drive online sales of seasonal apparel and accessories. Beretta Dealers are listed in each catalog, letting customers know where they can see and buy locally, as well as purchase firearms that are not available through the mail.

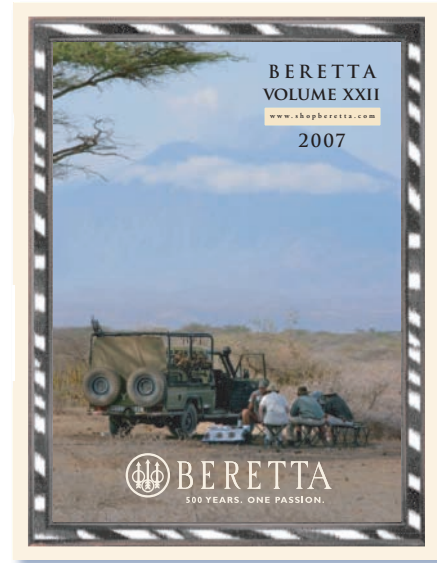
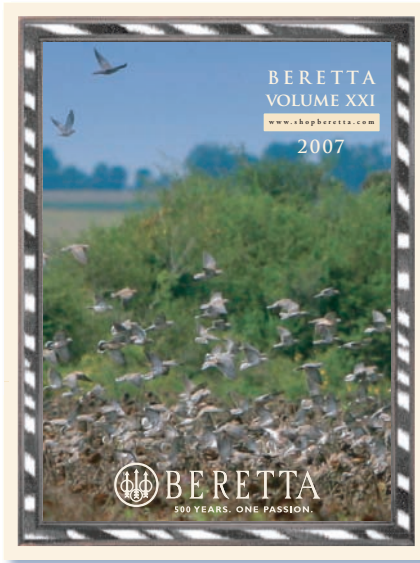

### WEBSITE

One of our most important and widely accessed venues of communication with our customers is through our state-of-the-art, interactive website. Here, we provide a wide range of information on all our products, allow the ease of home shopping, connect customers with each other through our Beretta Communities, and provide a directory to point them to their nearest Beretta dealer.

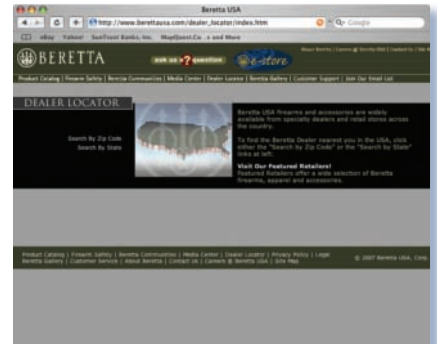

## COMMUNICATIONS OVERVIEW

### TEXAS MOTOR SPEEDWAY— A UNIQUE OPPORTUNITY

Beretta is the “Official Firearm of the Texas Motor Speedway.” Drawing crowds of more than 1 million people every year, Beretta enjoys a constant presence with track side signage visible not only at the track but on every televised race.

The Beretta sponsorship is highlighted at two Nextel Cup NASCAR races each year when the Dickies 500 pole winner is presented a Giubileo shotgun and the race winner a pair of Beretta Stampedes.

This sponsorship is even further enhanced with souvenir guide advertising, loudspeaker announcements and the presence of the Beretta Mobile Showroom on “vendor row”.



### CONSERVATION PARTNERSHIPS ARE AN IMPORTANT ALLIANCE

Preserving our hunting heritage becomes more difficult with each passing year as the lands on which we hunt continue to disappear. Beretta is proud to partner with a number of worthy organizations to help conserve our natural resources and protect wildlife habitat so that future generations will enjoy our hunting traditions. These partnership are instrumental in achieving that important goal and we urge your support of their efforts.





BERETTA  
FIREARMS INDEX

SHOTGUNS—PAGES 118-123

RIFLES— PAGES 123-126

WESTERN—PAGES 127-128

PISTOLS AND HOME PROTECTION—PAGES 128-130

## SHOTGUNS

### 471 EL SILVER HAWK

MODEL	CODE	GAUGE	CHOKE	BARREL	FINISH
471 EL SS, SF, GOLD-FILLED CASE COLORED	J470305	12	OCF	26"	OIL
471 EL SS, SF, GOLD-FILLED CASE COLORED	J470315	12	OCF	28"	OIL
471 EL SS, SF, GOLD-FILLED CASE COLORED	J470325	20	MC3	26"	OIL
471 EL SS, SF, GOLD-FILLED CASE COLORED	J470335	20	MC3	28"	OIL

### 471 SILVER HAWK

MODEL	CODE	GAUGE	CHOKE	BARREL	FINISH
471 SILVER HAWK SS, SF, SILVER RECEIVER	J471200	12	OCF	26"	OIL
471 SILVER HAWK SS, SF, SILVER RECEIVER	J471210	12	OCF	28"	OIL
471 SILVER HAWK SS, SF, SILVER RECEIVER	J471225	20	MCF	26"	OIL
471 SILVER HAWK SS, SF, SILVER RECEIVER	J471235	20	MCF	28"	OIL
471 SILVER HAWK PG, BF, SILVER RECEIVER	J471240	12	OCF	26"	OIL
471 SILVER HAWK PG, BF, SILVER RECEIVER	J471250	12	OCF	28"	OIL
471 SILVER HAWK PG, BF, SILVER RECEIVER	J471260	20	MCF	26"	OIL
471 SILVER HAWK PG, BF, SILVER RECEIVER	J471270	20	MCF	28"	OIL

### SV10 PERENNIA

MODEL	CODE	GAUGE	CHOKE	BARREL	FINISH
SV10 PERENNIA III	JV13A16	12	MCF	26"	OIL
SV10 PERENNIA III	JV13A18	12	MCF	28"	OIL
SV10 PERENNIA III KICK-OFF	JV13B18	12	MCF	28"	OIL

### PIGEON SERIES

MODEL	CODE	GAUGE	CHOKE	BARREL	FINISH
S687 ULTRALIGHT	J687559	12	MCF	28"	GLOSS
S687 ULTRALIGHT DELUXE	J687575	12	MCF	28"	OIL
686 SILVER PIGEON S	J686510	12	MCF	26"	GLOSS
686 SILVER PIGEON S	J686512	12	MCF	28"	GLOSS
686 SILVER PIGEON S	J686520	20	MCF	26"	GLOSS
686 SILVER PIGEON S	J686522	20	MCF	28"	GLOSS





**BERETTA**  
**FIREARMS INDEX**

PIGEON SERIES (CONTINUED)

MODEL	CODE	GAUGE	CHOKE	BARREL	FINISH
<b>686 SILVER PIGEON S COMBO</b>	J686530	20/28	MCF	26"/28"	GLOSS
<b>686 SILVER PIGEON S</b>	J686541	28	MCF	26"	GLOSS
<b>686 SILVER PIGEON S</b>	J686543	28	MCF	28"	GLOSS
<b>686 SILVER PIGEON S</b>	J686543L	28	MCF	28"	GLOSS
<b>686 SILVER PIGEON S</b>	J686552	.410	MCF	28"	GLOSS
<b>S687 SILVER PIGEON II</b>	J687105	12	MCF	26"	OIL
<b>S687 SILVER PIGEON II</b>	J687115	12	MCF	28"	OIL
<b>S687 SILVER PIGEON II</b>	J687135	20	MCF	26"	OIL
<b>S687 SILVER PIGEON II</b>	J687145	20	MCF	28"	OIL
<b>687 SILVER PIGEON II COMBO</b>	J687155	20/28	MCF	28"	OIL
<b>687 SILVER PIGEON III</b>	J6871G6	12	MCF	26"	OIL
<b>687 SILVER PIGEON III</b>	J6871G8	12	MCF	28"	OIL
<b>687 SILVER PIGEON III</b>	J6871J6	20	MCF	26"	OIL
<b>687 SILVER PIGEON III</b>	J6871J8	20	MCF	28"	OIL
<b>687 SILVER PIGEON III</b>	J6871J8L	20	MCF	28"	OIL
<b>687 SILVER PIGEON III</b>	J6871K6	28	MCF	26"	OIL
<b>687 SILVER PIGEON III</b>	J6871K8	28	MCF	28"	OIL
<b>687 SILVER PIGEON IV</b>	J6871A6	12	MCF	26"	OIL
<b>687 SILVER PIGEON IV</b>	J6871A8	12	MCF	28"	OIL
<b>687 SILVER PIGEON IV</b>	J6871B6	20	MCF	26"	OIL
<b>687 SILVER PIGEON IV</b>	J6871B8	20	MCF	28"	OIL
<b>687 SILVER PIGEON IV</b>	J6871D6	28	MCF	26"	OIL
<b>687 SILVER PIGEON IV</b>	J6871D8	28	MCF	28"	OIL
<b>687 SILVER PIGEON V</b>	J6871N6	12	MCF	26"	OIL
<b>687 SILVER PIGEON V</b>	J6871N8	12	MCF	28"	OIL
<b>687 SILVER PIGEON V</b>	J6871Q6	20	MCF	26"	OIL
<b>687 SILVER PIGEON V</b>	J6871Q8	20	MCF	28"	OIL
<b>687 SILVER PIGEON V (ENGLISH STOCK)</b>	J6871Q8S	20	MCF	28"	OIL
<b>687 SILVER PIGEON V</b>	J6871R6	28	MCF	26"	OIL
<b>687 SILVER PIGEON V</b>	J6871R8	28	MCF	28"	OIL
<b>687 SILVER PIGEON V (ENGLISH STOCK)</b>	J6871R8S	28	MCF	28"	OIL
<b>687 SILVER PIGEON V</b>	J6871S8	.410	MCF	28"	OIL
<b>687 SILVER PIGEON V (ENGLISH STOCK)</b>	J6871S8S	.410	MCF	28"	OIL
<b>S687 EL GOLD PIGEON II COMBO</b>	J687260	20/28	MCF	28"	OIL
<b>S687 EL GOLD PIGEON II COMBO</b>	J687270	28/.410	MCF	28"	OIL
<b>S687 EELL DIAMOND PIGEON</b>	J687300	12	MCF	26"	OIL
<b>S687 EELL DIAMOND PIGEON</b>	J687310	12	MCF	28"	OIL
<b>S687 EELL DIAMOND PIGEON</b>	J687320	20	MCF	26"	OIL
<b>S687 EELL DIAMOND PIGEON (ENGLISH STOCK)</b>	J687330	20	MCF	26"	OIL
<b>S687 EELL DIAMOND PIGEON</b>	J687340	20	MCF	28"	OIL
<b>S687 EELL DIAMOND PIGEON</b>	J687350	28	MCF	26"	OIL
<b>S687 EELL DIAMOND PIGEON</b>	J687355	28	MCF	28"	OIL
<b>S687 EELL DIAMOND PIGEON COMBO</b>	J687385	20/28	MCF	28"	OIL
<b>S687 EELL DIAMOND PIGEON</b>	J687390	.410	MCF	26"	OIL
<b>S687 EELL DIAMOND PIGEON</b>	J687395	.410	MCF	28"	OIL
<b>S687 EELL DIAMOND PIGEON COMBO</b>	J6873A0	28/.410	MCF	28"	OIL



# BERETTA FIREARMS INDEX

## 391 SERIES

MODEL	CODE	GAUGE	CHOKE	BARREL	FINISH
AL391 TEKNYS GOLD	J39IT36	12	OBF	26"	OIL
AL391 TEKNYS GOLD	J39IT38	12	OBF	28"	OIL
AL391 TEKNYS GOLD	J39IT46	20	MCF	26"	OIL
AL391 TEKNYS GOLD	J39IT48	20	MCF	28"	OIL
AL391 URIKA2 XTRA GRAIN	J39TA16	12	OBF	26"	MATTE
AL391 URIKA2 XTRA GRAIN	J39TA18	12	OBF	28"	MATTE
AL391 URIKA2 XTRA GRAIN	J39TA26	20	MCF	26"	MATTE
AL391 URIKA2 XTRA GRAIN	J39TA28	20	MCF	28"	MATTE
AL391 URIKA2 GOLD	J39TB18	12	OBF	28"	OIL
AL391 URIKA2 GOLD	J39TB26	20	MCF	26"	OIL
AL391 URIKA2 YOUTH XTRA GRAIN	J39TC24	20	MCF	24"	MATTE
AL391 URIKA2 SYNTHETIC KICK-OFF	J39TD18	12	OBF	28"	SYNTHETIC
AL391 URIKA2 CAMO MAX-4 KICK-OFF	J39TE18	12	OBF	28"	CAMO
AL391 URIKA2 CAMO AP (ALL PURPOSE) KICK-OFF	J39TR16	12	OBF	26"	CAMO
AL391 URIKA2 SYNTHETIC	J39TT18	12	OBF	28"	SYNTHETIC
AL391 URIKA2 CAMO MAX-4	J39TU18	12	OBF	28"	CAMO
AL391 URIKA2 CAMO AP (ALL PURPOSE)	J39TV16	12	OBF	26"	CAMO
A391 XTREMA2 SYNTHETIC	J39IA26	12	OBF	26"	SYNTHETIC
A391 XTREMA2 SYNTHETIC	J39IA28	12	OBF	28"	SYNTHETIC
A391 XTREMA2 CAMO AP (ALL PURPOSE)	J39IJ26	12	OBF	26"	CAMO
A391 XTREMA2 CAMO MAX-4 HD	J39IC26	12	OBF	26"	CAMO
A391 XTREMA2 CAMO MAX-4 HD	J39IC28	12	OBF	28"	CAMO
A391 XTREMA2 SYNTHETIC KICK-OFF	J39ID26	12	OBF	26"	SYNTHETIC
A391 XTREMA2 SYNTHETIC KICK-OFF	J39ID28	12	OBF	28"	SYNTHETIC
A391 XTREMA2 CAMO AP (ALL PURPOSE) KICK-OFF	J39IK26	12	OBF	26"	CAMO
A391 XTREMA2 CAMO MAX-4 HD KICK-OFF	J39IF26	12	OBF	26"	CAMO
A391 XTREMA2 CAMO MAX-4 HD KICK-OFF	J39IF28	12	OBF	28"	CAMO

## ONYX SERIES

MODEL	CODE	GAUGE	CHOKE	BARREL	FINISH
686 WHITE ONYX	J6862J6	12	MCF	26"	GLOSS
686 WHITE ONYX	J6862J8	12	MCF	28"	GLOSS
686 WHITE ONYX	J6862K6	20	MCF	26"	GLOSS
686 WHITE ONYX	J6862K8	20	MCF	28"	GLOSS
686 WHITE ONYX	J6862K8L	20	MCF	28"	GLOSS
686 WHITE ONYX	J6862M6	28	MCF	26"	GLOSS
686 WHITE ONYX	J6862M8	28	MCF	28"	GLOSS

## KING RANCH

MODEL	CODE	GAUGE	CHOKE	BARREL	FINISH
AL391 KING RANCH GOLD TEKNYS	J539IKR1	12	OBF	26"	GLOSS
AL391 KING RANCH GOLD TEKNYS	J539IKR2	12	OBF	28"	GLOSS
AL391 KING RANCH GOLD TEKNYS	J539IKR3	20	MCF	26"	GLOSS
AL391 KING RANCH GOLD TEKNYS	J539IKR4	20	MCF	28"	GLOSS
686 SILVER PIGEON S KING RANCH	J5686KR1	20	MCF	26"	GLOSS
686 SILVER PIGEON S KING RANCH	J5686KR2	20	MCF	28"	GLOSS



# BERETTA FIREARMS INDEX

## KING RANCH (CONTINUED)

MODEL	CODE	GAUGE	CHOKE	BARREL	FINISH
686 SILVER PIGEON S KING RANCH	JS686KR3	28	MCF	26"	GLOSS
686 SILVER PIGEON S KING RANCH	JS686KR4	28	MCF	28"	GLOSS
687 SILVER PIGEON IV KING RANCH	JS687KR1	20	MCF	26"	OIL
687 SILVER PIGEON IV KING RANCH	JS687KR2	20	MCF	28"	OIL
687 SILVER PIGEON IV KING RANCH	JS687KR3	28	MCF	26"	OIL
687 SILVER PIGEON IV KING RANCH	JS687KR4	28	MCF	28"	OIL
687 EELL DIAMOND PIGEON KING RANCH	JS687KR5	12	MCF	26"	OIL
687 EELL DIAMOND PIGEON KING RANCH	JS687KR6	12	MCF	28"	OIL
687 EELL DIAMOND PIGEON KING RANCH	JS687KR8	20	MCF	28"	OIL
687 EELL DIAMOND PIGEON KING RANCH	JS687KR10	28	MCF	28"	OIL
687 EELL DIAMOND PIGEON KING RANCH	JS687KR12	.410	MCF	28"	OIL

## 3901 SERIES

MODEL	CODE	GAUGE	CHOKE	BARREL	FINISH
3901 CITIZEN, SYNTHETIC	J390C16	12	MC3	26"	SYNTHETIC
3901 CITIZEN, SYNTHETIC	J390C18	12	MC3	28"	SYNTHETIC
3901 CITIZEN, SYNTHETIC RL	J390C26	20	MC3	26"	SYNTHETIC
3901 STATESMAN	J390S16	12	MC3	26"	SEMIGLOSS
3901 STATESMAN	J390S18	12	MC3	28"	SEMIGLOSS
3901 STATESMAN	J390S26	20	MC3	26"	SEMIGLOSS
3901 TARGET RL	J390Y16	12	IC ONLY	26"	OIL
3901 TARGET RL	J390Y18	12	IC ONLY	28"	OIL
3901 RIFLED SLUG	J390R14	12	N/A	24"	SYNTHETIC

## UGB25

MODEL	CODE	GAUGE	CHOKE	BARREL	FINISH
UGB25 XCEL TRAP	JUX5T10	12	OBF	30"	OIL
UGB25 XCEL TRAP	JUX5T12	12	OBF	32"	OIL

## DT10 TRIDENT

MODEL	CODE	GAUGE	CHOKE	BARREL	FINISH
DT10 TRIDENT TRAP, ADJ. STOCK	JDT1100	12	OBTR	30"	GLOSS
DT10 TRIDENT TRAP, ADJ. STOCK	JDT1110	12	OBTR	32"	GLOSS
DT10 TRIDENT TRAP, TOP SINGLE, ADJ. STOCK	JDT2110	12	OBTR	34"	GLOSS
DT10 TRIDENT TRAP, BOTTOM SINGLE	JDT2130	12	OBTS	34"	GLOSS
DT10 TRIDENT TRAP, COMBO, TOP SING, ADJ. STK.	JDT3100	12	OBTR	30"/34"	GLOSS
DT10 TRIDENT TRAP, COMBO, TOP SING, ADJ. STK.	JDT3110	12	OBTR	32"/34"	GLOSS
DT10 TRIDENT TRAP, COMBO, BOTTOM SINGLE, ADJ. STK.	JDT3130	12	OBTR	32"/34"	GLOSS
DT10 TRIDENT, SKEET, ADJ. STOCK	JDT4100	12	OBSK	28"	GLOSS
DT10 TRIDENT, SKEET, ADJ. STOCK	JDT4110	12	OBSK	30"	GLOSS
DT10 TRIDENT, SPORTING	JDT7100	12	OBSK	28"	GLOSS
DT10 TRIDENT SPORTING	JDT7110	12	OBSK	30"	GLOSS
DT10 TRIDENT SPORTING	JDT7120	12	OBSK	32"	GLOSS
DT10 TRIDENT L SPORTING	JDT7210	12	OBSK	30"	GLOSS
DT10 TRIDENT L SPORTING	JDT7220	12	OBSK	32"	GLOSS



# BERETTA FIREARMS INDEX

## 682 GOLD E

MODEL	CODE	GAUGE	CHOKE	BARREL	FINISH
682 GOLD E TRAP, ADJ. STOCK	J682E10	12	OBTR	30"	GLOSS
682 GOLD E TRAP, ADJ. STOCK	J682E12	12	OBTR	32"	GLOSS
682 GOLD E TRAP, COMBO TOP SINGLE	J682E30	12	OBTR	30"/34"	GLOSS
682 GOLD E TRAP, COMBO TOP SINGLE	J682E32	12	OBTR	32"/34"	GLOSS
682 GOLD E SKEET, ADJ. STOCK	J682E40	12	OBSK	28"	GLOSS
682 GOLD E SKEET, ADJ. STOCK	J682E42	12	OBSK	30"	GLOSS
682 GOLD E SPORTING	J682E70	12	OBSP	28"	GLOSS
682 GOLD E SPORTING	J682E72	12	OBSP	30"	GLOSS
682 GOLD E SPORTING	J682E74	12	OBSP	32"	GLOSS
682 GOLD E TRAP, BOTTOM SINGLE COMBO	J682E20	12	OBTR	30/34"	OIL
682 GOLD E TRAP, BOTTOM SINGLE COMBO	J682E22	12	OBTR	32/34"	OIL
682 GOLD E TRAP, BOTTOM SINGLE	J682E25	12	OBTS	34"	OIL

## SILVER PIGEON SERIES (COMPETITION)

MODEL	CODE	GAUGE	CHOKE	BARREL	FINISH
687 SILVER PIGEON II SPORTING	J687406	12	OBSP	28"	OIL
687 SILVER PIGEON II SPORTING	J687416	12	OBSP	30"	OIL
687 SILVER PIGEON II SPORTING	J687418	12	OBSP	32"	OIL
687 SILVER PIGEON II SPORTING	J687425	20	MCS2	28"	OIL
687 SILVER PIGEON II SPORTING	J687435	20	MCS2	30"	OIL
687 SILVER PIGEON II SPORTING	J687437	28	MCS2	30"	OIL
687 SILVER PIGEON III SPORTING	J6874A0	12	OBSP	30"	OIL
687 SILVER PIGEON III SPORTING	J6874A2	12	OBSP	32"	OIL

## DIAMOND PIGEON SERIES (COMPETITION)

MODEL	CODE	GAUGE	CHOKE	BARREL	FINISH
687 EELL DIAMOND PIGEON SPORTING	J687956	12	OBF	28"	OIL
687 EELL DIAMOND PIGEON SPORTING	J687966	12	OBF	30"	OIL
687 EELL DIAMOND PIGEON SPORTING	J687976	12	OBF	32"	OIL
687 EELL DIAMOND PIGEON SPORTING	J687980	20	MCF	30"	OIL
687 EELL DIAMOND PIGEON SPORTING	J687985	28	MCF	30"	OIL
687 EELL DIAMOND PIGEON SPORTING	J687990	.410	MCF	30"	OIL

## WHITE ONYX AND AL391 SERIES

MODEL	CODE	GAUGE	CHOKE	BARREL	FINISH
686 WHITE ONYX SPORTING	J6868A0	12	OBSP	30"	OIL
686 WHITE ONYX SPORTING	J6868A2	12	OBSP	32"	OIL
AL391 TEKNYS GOLD SPORTING	J391T70	12	OBS	30"	OIL
AL391 TEKNYS GOLD SPORTING	J391T78	12	OBS	28"	OIL
AL391 TEKNYS GOLD SPORTING	J391T80	20	MCS2	30"	OIL
AL391 TEKNYS GOLD SPORTING	J391T88	20	MCS2	28"	OIL
AL391 TEKNYS GOLD TRAP	J391T90	12	OBS	30"	OIL
AL391 TEKNYS GOLD TRAP	J391T92	12	OBS	32"	OIL
AL391 TEKNYS GOLD TARGET	J391T00	12	OBS	30"	OIL
AL391 URIKA2 SPORTING XTRA GRAIN	J39TJ10	12	OBS	30"	MATTE
AL391 URIKA2 SPORTING XTRA GRAIN	J39TJ18	12	OBS	28"	MATTE



# BERETTA FIREARMS INDEX

## WHITE ONYX AND AL391 SERIES (CONTINUED)

MODEL	CODE	GAUGE	CHOKE	BARREL	FINISH
AL391 URIKA2 SPORTING XTRA GRAIN	J39TJ20	20	MCS	30"	MATTE
AL391 URIKA2 SPORTING XTRA GRAIN	J39TJ28	20	MCS	28"	MATTE
AL391 URIKA2 GOLD SPORTING	J39TK10	12	OBS	30"	OIL
AL391 URIKA2 GOLD SPORTING	J39TK18	12	OBS	28"	OIL
AL391 URIKA2 PARALLEL TARGET RL XTRA GRAIN	J39TM10	12	OBS	30"	MATTE
AL391 URIKA2 PARALLEL TARGET RL XTRA GRAIN	J39TM18	12	OBS	28"	MATTE
AL391 URIKA2 PARALLEL TARGET SL XTRA GRAIN	J39TN10	12	OBS	30"	MATTE
AL391 URIKA2 PARALLEL TARGET SL XTRA GRAIN	J39TN12	12	OBS	32"	MATTE
AL391 URIKA2 GOLD PARALLEL TARGET SL	J39TP10	12	OBS	30"	OIL
AL391 URIKA2 GOLD PARALLEL TARGET SL	J39TP12	12	OBS	32"	OIL
AL391 URIKA2 SPORTING SYNTHETIC KICK-OFF	J39TX10	12	OBS	30"	SYNTHETIC

## RIFLES

### SAKO 85 HUNTER

MODEL	CODE	CALIBER	ACTION	BARREL	FINISH	MAGAZINE CAPACITY
SAKO 85 HUNTER	JRS1A12	.233 REM	S	22 <sup>7</sup> / <sub>16</sub> "	WOOD/BLUED	5 ROUNDS
SAKO 85 HUNTER	JRS1A14	.22-250 REM	S	22 <sup>7</sup> / <sub>16</sub> "	WOOD/BLUED	5 ROUNDS
SAKO 85 HUNTER	JRS1A15	.243 WIN	S	22 <sup>7</sup> / <sub>16</sub> "	WOOD/BLUED	5 ROUNDS
SAKO 85 HUNTER	JRS1A16	.308 WIN	S	22 <sup>7</sup> / <sub>16</sub> "	WOOD/BLUED	5 ROUNDS
SAKO 85 HUNTER	JRS1A17	.25-06 REM	M	22 <sup>7</sup> / <sub>16</sub> "	WOOD/BLUED	5 ROUNDS
SAKO 85 HUNTER	JRS1A18	.270 WIN	M	22 <sup>7</sup> / <sub>16</sub> "	WOOD/BLUED	5 ROUNDS
SAKO 85 HUNTER	JRS1A20	.30-06 SPRG	M	22 <sup>7</sup> / <sub>16</sub> "	WOOD/BLUED	5 ROUNDS
SAKO 85 HUNTER	JRS1A21	.260 REM	M	22 <sup>7</sup> / <sub>16</sub> "	WOOD/BLUED	5 ROUNDS
SAKO 85 HUNTER	JRS1A31	.300 WIN MAG	L	24 <sup>3</sup> / <sub>8</sub> "	WOOD/BLUED	5 ROUNDS
SAKO 85 HUNTER	JRS1A34	.338 WIN MAG	L	24 <sup>3</sup> / <sub>8</sub> "	WOOD/BLUED	5 ROUNDS
SAKO 85 HUNTER	JRS1A35	.370 SAKO MAG	M	24 <sup>3</sup> / <sub>8</sub> "	WOOD/BLUED	5 ROUNDS
SAKO 85 HUNTER	JRS1A37	.375 H&H MAG	L	24 <sup>3</sup> / <sub>8</sub> "	WOOD/BLUED	5 ROUNDS
SAKO 85 HUNTER	JRS1A40	.270 WSM	SM	24 <sup>3</sup> / <sub>8</sub> "	WOOD/BLUED	4 ROUNDS
SAKO 85 HUNTER	JRS1A41	.300 WSM	SM	24 <sup>3</sup> / <sub>8</sub> "	WOOD/BLUED	4 ROUNDS
SAKO 85 HUNTER	JRS1A43	.338 FEDERAL	S	22 <sup>7</sup> / <sub>16</sub> "	WOOD/BLUED	5 ROUNDS
SAKO 85 HUNTER	JRS1A51	6.5X55	M	22 <sup>7</sup> / <sub>16</sub> "	WOOD/BLUED	5 ROUNDS
SAKO 85 HUNTER	JRS1A52	7MM-08	S	22 <sup>7</sup> / <sub>16</sub> "	WOOD/BLUED	5 ROUNDS
SAKO 85 HUNTER	JRS1A70	7MM REM MAG	L	22 <sup>3</sup> / <sub>8</sub> "	WOOD/BLUED	4 ROUNDS

### SAKO 85 FINNLIGHT

MODEL	CODE	CALIBER	ACTION	BARREL	FINISH	MAGAZINE CAPACITY
SAKO 85 FINNLIGHT	JRS1Q15	.243 WIN	85 S	20 <sup>7</sup> / <sub>8</sub> "	STAINLESS STEEL	5 ROUNDS
SAKO 85 FINNLIGHT	JRS1Q16	.308 WIN	85 S	20 <sup>7</sup> / <sub>8</sub> "	STAINLESS STEEL	5 ROUNDS
SAKO 85 FINNLIGHT	JRS1Q17	.25-06 REM	85 M	20 <sup>7</sup> / <sub>8</sub> "	STAINLESS STEEL	5 ROUNDS
SAKO 85 FINNLIGHT	JRS1Q18	.270 WSM	85 M	20 <sup>7</sup> / <sub>8</sub> "	STAINLESS STEEL	5 ROUNDS



# BERETTA FIREARMS INDEX

## SAKO 85 FINNLIGHT (CONTINUED)

MODEL	CODE	CALIBER	ACTION	BARREL	FINISH	MAGAZINE CAPACITY
SAKO 85 FINNLIGHT	JRS1Q20	.30-06 SPRG	85 M	20 <sup>7</sup> / <sub>8</sub> "	STAINLESS STEEL	5 ROUNDS
SAKO 85 FINNLIGHT	JRS1Q21	.260 REM	85 M	20 <sup>7</sup> / <sub>8</sub> "	STAINLESS STEEL	5 ROUNDS
SAKO 85 FINNLIGHT	JRS2Q40	.270 WSM	85 SHORT MAGNUM	24 <sup>3</sup> / <sub>8</sub> "	STAINLESS STEEL	5 ROUNDS
SAKO 85 FINNLIGHT	JRS2Q41	.300 WSM	85 SHORT MAGNUM	24 <sup>3</sup> / <sub>8</sub> "	STAINLESS STEEL	5 ROUNDS
SAKO 85 FINNLIGHT	JRS1Q52	7MM-08 REM	85 S	20 <sup>7</sup> / <sub>8</sub> "	STAINLESS STEEL	5 ROUNDS
SAKO 85 FINNLIGHT	JRS1Q51	6.5X55 SWEDE	85 M	24 <sup>3</sup> / <sub>8</sub> "	STAINLESS STEEL	5 ROUNDS
SAKO 85 FINNLIGHT	JRS1Q70	7MM REM MAG	85 L	24 <sup>3</sup> / <sub>8</sub> "	STAINLESS STEEL	5 ROUNDS
SAKO 85 FINNLIGHT	JRS1Q31	.300 WIN MAG	85 L	24 <sup>3</sup> / <sub>8</sub> "	STAINLESS STEEL	5 ROUNDS

## SAKO 85 GREY WOLF

MODEL	CODE	CALIBER	ACTION	BARREL	FINISH	MAGAZINE CAPACITY
SAKO 85 GREY WOLF	JRS2C18	.270 WIN	85 M	22 <sup>7</sup> / <sub>16</sub> "	LAMINATED/STAINLESS	5 ROUNDS
SAKO 85 GREY WOLF	JRS2C20	.30-06 SPRG	85 M	22 <sup>7</sup> / <sub>16</sub> "	LAMINATED/STAINLESS	5 ROUNDS
SAKO 85 GREY WOLF	JRS2C21	.260 REM	85 M	22 <sup>7</sup> / <sub>16</sub> "	LAMINATED/STAINLESS	5 ROUNDS
SAKO 85 GREY WOLF	JRS2C40	.270 WSM	85 SHORT MAGNUM	24 <sup>3</sup> / <sub>8</sub> "	LAMINATED/STAINLESS	5 ROUNDS
SAKO 85 GREY WOLF	JRS2C41	.300 WSM	85 SHORT MAGNUM	24 <sup>3</sup> / <sub>8</sub> "	LAMINATED/STAINLESS	5 ROUNDS
SAKO 85 GREY WOLF	JRS2C52	7MM-08 REM	85 M	22 <sup>7</sup> / <sub>16</sub> "	LAMINATED/STAINLESS	5 ROUNDS
SAKO 85 GREY WOLF	JRS2C70	7MM REM MAG	85 L	24 <sup>3</sup> / <sub>8</sub> "	LAMINATED/STAINLESS	5 ROUNDS
SAKO 85 GREY WOLF	JRS2C31	.300 WIN MAG	85 L	24 <sup>3</sup> / <sub>8</sub> "	LAMINATED/STAINLESS	5 ROUNDS
SAKO 85 GREY WOLF	JRS2C34	.338 WIN MAG	85 L	24 <sup>3</sup> / <sub>8</sub> "	LAMINATED/STAINLESS	5 ROUNDS
SAKO 85 GREY WOLF	JRS2C43	.338 FEDERAL	85 S	22 <sup>7</sup> / <sub>16</sub> "	LAMINATED/STAINLESS	5 ROUNDS

## SAKO 85 VARMIN T

MODEL	CODE	CALIBER	ACTION	BARREL	FINISH	MAGAZINE CAPACITY
SAKO 85 VARMIN T SET TRIGGER	JRS1F12	.223 REM	85 XS	23 <sup>5</sup> / <sub>8</sub> "	BLUED	5 ROUNDS
SAKO 85 VARMIN T SET TRIGGER	JRS1F14	.22-250 REM	85 S	23 <sup>5</sup> / <sub>8</sub> "	BLUED	5 ROUNDS
SAKO 85 VARMIN T SET TRIGGER	JRS1F15	.243 WIN	85 S	23 <sup>5</sup> / <sub>8</sub> "	BLUED	5 ROUNDS
SAKO 85 VARMIN T SET TRIGGER	JRS1F16	.308 WIN	85 S	23 <sup>5</sup> / <sub>8</sub> "	BLUED	5 ROUNDS
SAKO 85 VARMIN T SET TRIGGER	JRS1F22	.204 RUGER	85 XS	23 <sup>5</sup> / <sub>8</sub> "	BLUED	5 ROUNDS

## SAKO 85 VARMIN T STAINLESS LAMINATED

MODEL	CODE	CALIBER	ACTION	BARREL	FINISH	MAGAZINE CAPACITY
SAKO 85 VARMIN T SS LAM. WITH SET TRIGGER	JRS1G12	.223 REM	85 XS	23 <sup>5</sup> / <sub>8</sub> "	STAINLESS STEEL	5 ROUNDS
SAKO 85 VARMIN T SS LAM. WITH SET TRIGGER	JRS1G14	.22-250 REM	85 S	23 <sup>5</sup> / <sub>8</sub> "	STAINLESS STEEL	5 ROUNDS
SAKO 85 VARMIN T LAM. WITH SET TRIGGER	JRS1G15	.243 WIN	85 S	23 <sup>5</sup> / <sub>8</sub> "	STAINLESS STEEL	5 ROUNDS
SAKO 85 VARMIN T LAM. WITH SET TRIGGER	JRS1G16	.308 WIN	85 S	23 <sup>5</sup> / <sub>8</sub> "	STAINLESS STEEL	5 ROUNDS
SAKO 85 VARMIN T LAM. WITH SET TRIGGER	JRS1G22	.204 RUGER	85 XS	23 <sup>5</sup> / <sub>8</sub> "	STAINLESS STEEL	5 ROUNDS



# BERETTA FIREARMS INDEX

## SAKO QUAD HUNTER

MODEL	CODE	CALIBER	ACTION	BARREL	FINISH	MAGAZINE CAPACITY
<b>SAKO QUAD HUNTER 4-BARREL COMBO</b>	JRSR4C1	.17 MACH2, .17 HMR, .22LR, .22 WMR	QUAD (P04)	22"	WOOD/BLUED	5 ROUNDS
<b>SAKO QUAD HUNTER 2-BARREL COMBO</b>	JRSR5C2	.17 HMR, .22LR	QUAD (P04)	22"	WOOD/BLUED	5 ROUNDS

## SAKO A7

MODEL	CODE	CALIBER	ACTION	BARREL	FINISH	MAGAZINE CAPACITY
<b>SAKO A7</b>	JRSY114	.22-250 REM	A7 SHORT	22 <sup>7</sup> / <sub>16</sub> "	BLUED STEEL	3 ROUNDS
<b>SAKO A7</b>	JRSY115	.243 WIN	A7 SHORT	22 <sup>7</sup> / <sub>16</sub> "	BLUED STEEL	3 ROUNDS
<b>SAKO A7</b>	JRSY116	.308 WIN	A7 SHORT	22 <sup>7</sup> / <sub>16</sub> "	BLUED STEEL	3 ROUNDS
<b>SAKO A7</b>	JRSY117	.25-06 REM	A7 MEDIUM	22 <sup>7</sup> / <sub>16</sub> "	BLUED STEEL	3 ROUNDS
<b>SAKO A7</b>	JRSY118	.270 WIN	A7 MEDIUM	22 <sup>7</sup> / <sub>16</sub> "	BLUED STEEL	3 ROUNDS
<b>SAKO A7</b>	JRSY120	.30-06 SPRG	A7 MEDIUM	22 <sup>7</sup> / <sub>16</sub> "	BLUED STEEL	3 ROUNDS
<b>SAKO A7</b>	JRSY131	.300 WIN MAG	A7 MEDIUM	24 <sup>3</sup> / <sub>8</sub> "	BLUED STEEL	3 ROUNDS
<b>SAKO A7</b>	JRSY140	.270 WSM	A7 SHORT	22 <sup>7</sup> / <sub>16</sub> "	BLUED STEEL	3 ROUNDS
<b>SAKO A7</b>	JRSY141	.300 WSM	A7 SHORT	24 <sup>3</sup> / <sub>8</sub> "	BLUED STEEL	3 ROUNDS
<b>SAKO A7</b>	JRSY143	.338 FEDERAL	A7 SHORT	22 <sup>7</sup> / <sub>16</sub> "	BLUED STEEL	3 ROUNDS
<b>SAKO A7</b>	JRSY152	7MM-08 REM	A7 SHORT	22 <sup>7</sup> / <sub>16</sub> "	BLUED STEEL	3 ROUNDS
<b>SAKO A7</b>	JRSY170	7MM REM MAG	A7 MEDIUM	24 <sup>3</sup> / <sub>8</sub> "	BLUED STEEL	3 ROUNDS
<b>SAKO A7 STAINLESS STEEL</b>	JRSZ114	.22-250 REM	A7 SHORT	22 <sup>7</sup> / <sub>16</sub> "	STAINLESS STEEL	3 ROUNDS
<b>SAKO A7 STAINLESS STEEL</b>	JRSZ115	.243 WIN	A7 SHORT	22 <sup>7</sup> / <sub>16</sub> "	STAINLESS STEEL	3 ROUNDS
<b>SAKO A7 STAINLESS STEEL</b>	JRSZ116	.308 WIN	A7 SHORT	22 <sup>7</sup> / <sub>16</sub> "	STAINLESS STEEL	3 ROUNDS
<b>SAKO A7 STAINLESS STEEL</b>	JRSZ117	.25-06 REM	A7 MEDIUM	22 <sup>7</sup> / <sub>16</sub> "	STAINLESS STEEL	3 ROUNDS
<b>SAKO A7 STAINLESS STEEL</b>	JRSZ118	.270 WIN	A7 MEDIUM	22 <sup>7</sup> / <sub>16</sub> "	STAINLESS STEEL	3 ROUNDS
<b>SAKO A7 STAINLESS STEEL</b>	JRSZ120	.30-06 SPRG	A7 MEDIUM	22 <sup>7</sup> / <sub>16</sub> "	STAINLESS STEEL	3 ROUNDS
<b>SAKO A7 STAINLESS STEEL</b>	JRSZ131	.300 WIN MAG	A7 MEDIUM	24 <sup>3</sup> / <sub>8</sub> "	STAINLESS STEEL	3 ROUNDS
<b>SAKO A7 STAINLESS STEEL</b>	JRSZ140	.270 WSM	A7 SHORT	22 <sup>7</sup> / <sub>16</sub> "	STAINLESS STEEL	3 ROUNDS
<b>SAKO A7 STAINLESS STEEL</b>	JRSZ141	.300 WSM	A7 SHORT	24 <sup>3</sup> / <sub>8</sub> "	STAINLESS STEEL	3 ROUNDS
<b>SAKO A7 STAINLESS STEEL</b>	JRSZ143	.338 FEDERAL	A7 SHORT	22 <sup>7</sup> / <sub>16</sub> "	STAINLESS STEEL	3 ROUNDS
<b>SAKO A7 STAINLESS STEEL</b>	JRSZ152	7MM-08 REM	A7 SHORT	22 <sup>7</sup> / <sub>16</sub> "	STAINLESS STEEL	3 ROUNDS
<b>SAKO A7 STAINLESS STEEL</b>	JRSZ170	7MM REM MAG	A7 MEDIUM	24 <sup>3</sup> / <sub>8</sub> "	STAINLESS STEEL	3 ROUNDS

## SAKO TRG 22/42

MODEL	CODE	CALIBER	ACTION	BARREL	FINISH	MAGAZINE CAPACITY
<b>SAKO TRG 22 GREEN</b>	JRSM216	.308 WIN	TRG 22	26"	COMPOSITE/PHOSPHATE	10 ROUNDS
<b>SAKO TRG 22 BLACK</b>	JRSM316	.308 WIN	TRG 22	26"	COMPOSITE/PHOSPHATE	10 ROUNDS
<b>SAKO TRG 22 DESERT TAN</b>	JRSM716	.308 WIN	TRG 22	26"	COMPOSITE/PHOSPHATE	10 ROUNDS
<b>SAKO TRG 22 FOLDING STOCK</b>	JRSM416	.308 WIN	TRG 22	20"	COMPOSITE/PHOSPHATE	10 ROUNDS
<b>SAKO TRG 42 BLACK</b>	JRSM131	.338 WIN MAG	TRG 42	27 <sup>1</sup> / <sub>8</sub> "	COMPOSITE/PHOSPHATE	7 ROUNDS
<b>SAKO TRG 42 BLACK</b>	JRSM135	.338 LAPUA	TRG 42	27 <sup>1</sup> / <sub>8</sub> "	COMPOSITE/PHOSPHATE	5 ROUNDS
<b>SAKO TRG 42 GREEN</b>	JRSM231	.300 WIN MAG	TRG 42	27 <sup>1</sup> / <sub>8</sub> "	COMPOSITE/PHOSPHATE	7 ROUNDS
<b>SAKO TRG 42 GREEN</b>	JRSM235	.338 LAPUA	TRG 42	27 <sup>1</sup> / <sub>8</sub> "	COMPOSITE/PHOSPHATE	5 ROUNDS
<b>SAKO TRG 42 DESERT TAN</b>	JRSM735	.338 LAPUA	TRG 42	27 <sup>1</sup> / <sub>8</sub> "	COMPOSITE/PHOSPHATE	5 ROUNDS



# BERETTA FIREARMS INDEX

## T3 HUNTER

MODEL	CODE	CALIBER	ACTION	BARREL	FINISH	MAGAZINE CAPACITY
T3 HUNTER	JRTA312	.223 REM	T3	22 <sup>7</sup> / <sub>16</sub> "	WOOD/BLUED	4 ROUNDS
T3 HUNTER	JRTA314	.22-250 REM	T3	22 <sup>7</sup> / <sub>16</sub> "	WOOD/BLUED	3 ROUNDS
T3 HUNTER	JRTA315	.243 WIN	T3	22 <sup>7</sup> / <sub>16</sub> "	WOOD/BLUED	3 ROUNDS
T3 HUNTER	JRTA316	.308 WIN	T3	22 <sup>7</sup> / <sub>16</sub> "	WOOD/BLUED	3 ROUNDS
T3 HUNTER	JRTA317	.25-06 REM	T3	22 <sup>7</sup> / <sub>16</sub> "	WOOD/BLUED	3 ROUNDS
T3 HUNTER	JRTA318	.270 WIN	T3	22 <sup>7</sup> / <sub>16</sub> "	WOOD/BLUED	3 ROUNDS
T3 HUNTER	JRTA320	.30-06 SPRG	T3	22 <sup>7</sup> / <sub>16</sub> "	WOOD/BLUED	3 ROUNDS
T3 HUNTER	JRTA331	.300 WIN MAG	T3	24 <sup>3</sup> / <sub>8</sub> "	WOOD/BLUED	3 ROUNDS
T3 HUNTER	JRTA334	.338 WIN MAG	T3	24 <sup>3</sup> / <sub>8</sub> "	WOOD/BLUED	3 ROUNDS
T3 HUNTER	JRTA340	.270 WSM	T3	24 <sup>3</sup> / <sub>8</sub> "	WOOD/BLUED	3 ROUNDS
T3 HUNTER	JRTA341	.300 WSM	T3	24 <sup>3</sup> / <sub>8</sub> "	WOOD/BLUED	3 ROUNDS
T3 HUNTER	JRTA343	.338 FEDERAL	T3	22 <sup>7</sup> / <sub>16</sub> "	WOOD/BLUED	3 ROUNDS
T3 HUNTER	JRTA370	7MM REM MAG	T3	24 <sup>3</sup> / <sub>8</sub> "	WOOD/BLUED	3 ROUNDS
T3 HUNTER	JRTA352	7MM-08 REM	T3	22 <sup>7</sup> / <sub>16</sub> "	WOOD/BLUED	3 ROUNDS
T3 HUNTER	JRTA351	6.5X55 SWEDISH	T3	22 <sup>7</sup> / <sub>16</sub> "	WOOD/BLUED	3 ROUNDS

## T3 LITE SYNTHETIC

MODEL	CODE	CALIBER	ACTION	BARREL	FINISH	MAGAZINE CAPACITY
T3 LITE, SYNTHETIC	JRTE312	.223 REM	T3	22 <sup>7</sup> / <sub>16</sub> "	SYNTHETIC/BLUED	4 ROUNDS
T3 LITE, SYNTHETIC	JRTE314	.22-250 REM	T3	22 <sup>7</sup> / <sub>16</sub> "	SYNTHETIC/BLUED	3 ROUNDS
T3 LITE, SYNTHETIC	JRTE315	.243 WIN	T3	22 <sup>7</sup> / <sub>16</sub> "	SYNTHETIC/BLUED	3 ROUNDS
T3 LITE, SYNTHETIC	JRTE316	.308 WIN	T3	22 <sup>7</sup> / <sub>16</sub> "	SYNTHETIC/BLUED	3 ROUNDS
T3 LITE, SYNTHETIC	JRTE317	.25-06 REM	T3	22 <sup>7</sup> / <sub>16</sub> "	SYNTHETIC/BLUED	3 ROUNDS
T3 LITE, SYNTHETIC	JRTE318	.270 WIN	T3	22 <sup>7</sup> / <sub>16</sub> "	SYNTHETIC/BLUED	3 ROUNDS
T3 LITE, SYNTHETIC	JRTE320	.30-06 SPRG	T3	22 <sup>7</sup> / <sub>16</sub> "	SYNTHETIC/BLUED	3 ROUNDS
T3 LITE, SYNTHETIC	JRTE331	.300 WIN MAG	T3	24 <sup>3</sup> / <sub>8</sub> "	SYNTHETIC/BLUED	3 ROUNDS
T3 LITE, SYNTHETIC	JRTE334	.338 WIN MAG	T3	24 <sup>3</sup> / <sub>8</sub> "	SYNTHETIC/BLUED	3 ROUNDS
T3 LITE, SYNTHETIC	JRTE340	.270 WSM	T3	24 <sup>3</sup> / <sub>8</sub> "	SYNTHETIC/BLUED	3 ROUNDS
T3 LITE, SYNTHETIC	JRTE341	.300 WSM	T3	24 <sup>3</sup> / <sub>8</sub> "	SYNTHETIC/BLUED	3 ROUNDS
T3 LITE, SYNTHETIC	JRTE343	.338 FEDERAL	T3	22 <sup>7</sup> / <sub>16</sub> "	SYNTHETIC/BLUED	3 ROUNDS
T3 LITE, SYNTHETIC	JRTE352	7MM-08 REM	T3	22 <sup>7</sup> / <sub>16</sub> "	SYNTHETIC/BLUED	3 ROUNDS
T3 LITE, SYNTHETIC	JRTE370	7MM REM MAG	T3	24 <sup>3</sup> / <sub>8</sub> "	SYNTHETIC/BLUED	3 ROUNDS

## T3 TACTICAL

MODEL	CODE	CALIBER	ACTION	BARREL	FINISH	MAGAZINE CAPACITY
T3 TACTICAL	JRTM12	.223 REM	T3	20"	SYNTHETIC/PHOSPHATE	6 ROUNDS
T3 TACTICAL	JRTM16	.308 WIN	T3	20"	SYNTHETIC/PHOSPHATE	5 ROUNDS





# BERETTA FIREARMS INDEX

## T3 LITE STAINLESS

MODEL	CODE	CALIBER	ACTION	BARREL	FINISH	MAGAZINE CAPACITY
T3 LITE, S/S, SYNTHETIC	JRTB312	.223 REM	T3	22 <sup>7</sup> / <sub>16</sub> "	SYNTHETIC/STAINLESS	6 ROUNDS
T3 LITE, S/S, SYNTHETIC	JRTB314	.22-250 REM	T3	22 <sup>7</sup> / <sub>16</sub> "	SYNTHETIC/STAINLESS	6 ROUNDS
T3 LITE, S/S, SYNTHETIC	JRTB315	.243 WIN	T3	22 <sup>7</sup> / <sub>16</sub> "	SYNTHETIC/STAINLESS	6 ROUNDS
T3 LITE, S/S, SYNTHETIC	JRTB316	.308 WIN	T3	22 <sup>7</sup> / <sub>16</sub> "	SYNTHETIC/STAINLESS	6 ROUNDS
T3 LITE, S/S, SYNTHETIC	JRTB317	.25-06 REM	T3	22 <sup>7</sup> / <sub>16</sub> "	SYNTHETIC/STAINLESS	6 ROUNDS
T3 LITE, S/S, SYNTHETIC	JRTB318	.270 WIN	T3	22 <sup>7</sup> / <sub>16</sub> "	SYNTHETIC/STAINLESS	6 ROUNDS
T3 LITE, S/S, SYNTHETIC	JRTB320	.30-06 SPRG	T3	22 <sup>7</sup> / <sub>16</sub> "	SYNTHETIC/STAINLESS	6 ROUNDS
T3 LITE, S/S, SYNTHETIC	JRTB331	.300 WIN MAG	T3	24 <sup>3</sup> / <sub>8</sub> "	SYNTHETIC/STAINLESS	6 ROUNDS
T3 LITE, S/S, SYNTHETIC	JRTB334	.338 WIN MAG	T3	24 <sup>3</sup> / <sub>8</sub> "	SYNTHETIC/STAINLESS	6 ROUNDS
T3 LITE, S/S, SYNTHETIC	JRTB340	.270 WSM	T3	24 <sup>3</sup> / <sub>8</sub> "	SYNTHETIC/STAINLESS	6 ROUNDS
T3 LITE, S/S, SYNTHETIC	JRTB341	.300 WSM	T3	24 <sup>3</sup> / <sub>8</sub> "	SYNTHETIC/STAINLESS	6 ROUNDS
T3 LITE, S/S, SYNTHETIC	JRTB343	.338 FEDERAL	T3	22 <sup>7</sup> / <sub>16</sub> "	SYNTHETIC/STAINLESS	6 ROUNDS
T3 LITE, S/S, SYNTHETIC	JRTB370	7MM REM MAG	T3	24 <sup>3</sup> / <sub>8</sub> "	SYNTHETIC/STAINLESS	6 ROUNDS
T3 LITE, S/S, SYNTHETIC	JRTB352	7MM-08 REM	T3	22 <sup>7</sup> / <sub>16</sub> "	SYNTHETIC/STAINLESS	6 ROUNDS
T3 LITE, S/S, SYNTHETIC	JRTB351	6.5X55 SWEDISH	T3	22 <sup>7</sup> / <sub>16</sub> "	SYNTHETIC/STAINLESS	6 ROUNDS
T3 LITE, S/S, SYNTHETIC, LH	JRTB412	.223 REM	T3	22 <sup>7</sup> / <sub>16</sub> "	SYNTHETIC/STAINLESS	6 ROUNDS
T3 LITE, S/S, SYNTHETIC, LH	JRTB414	.22-250 REM	T3	22 <sup>7</sup> / <sub>16</sub> "	SYNTHETIC/STAINLESS	6 ROUNDS
T3 LITE, S/S, SYNTHETIC, LH	JRTB415	.243 WIN	T3	22 <sup>7</sup> / <sub>16</sub> "	SYNTHETIC/STAINLESS	6 ROUNDS
T3 LITE, S/S, SYNTHETIC, LH	JRTB416	.308 WIN	T3	22 <sup>7</sup> / <sub>16</sub> "	SYNTHETIC/STAINLESS	6 ROUNDS
T3 LITE, S/S, SYNTHETIC, LH	JRTB418	.270 WIN	T3	22 <sup>7</sup> / <sub>16</sub> "	SYNTHETIC/STAINLESS	6 ROUNDS
T3 LITE, S/S, SYNTHETIC, LH	JRTB420	.30-06 SPRG	T3	22 <sup>7</sup> / <sub>16</sub> "	SYNTHETIC/STAINLESS	6 ROUNDS
T3 LITE, S/S, SYNTHETIC, LH	JRTB431	.300 WIN MAG	T3	24 <sup>3</sup> / <sub>8</sub> "	SYNTHETIC/STAINLESS	6 ROUNDS
T3 LITE, S/S, SYNTHETIC, LH	JRTB440	.270 WSM	T3	24 <sup>3</sup> / <sub>8</sub> "	SYNTHETIC/STAINLESS	6 ROUNDS
T3 LITE, S/S, SYNTHETIC, LH	JRTB441	.300 WSM	T3	24 <sup>3</sup> / <sub>8</sub> "	SYNTHETIC/STAINLESS	6 ROUNDS
T3 LITE, S/S, SYNTHETIC, LH	JRTB470	7MM REM MAG	T3	24 <sup>3</sup> / <sub>8</sub> "	SYNTHETIC/STAINLESS	6 ROUNDS

## T3 VARMINT

MODEL	CODE	CALIBER	ACTION	BARREL	FINISH	MAGAZINE CAPACITY
T3 VARMINT	JRTH312	.223 REM	T3	23 <sup>3</sup> / <sub>8</sub> "	SYNTHETIC/BLUED	6 ROUNDS
T3 VARMINT	JRTH314	.22-250 REM	T3	23 <sup>3</sup> / <sub>8</sub> "	SYNTHETIC/BLUED	5 ROUNDS
T3 VARMINT	JRTH316	.308 WIN	T3	23 <sup>3</sup> / <sub>8</sub> "	SYNTHETIC/BLUED	5 ROUNDS



# BERETTA FIREARMS INDEX

## WESTERN

### STAMPEDE REVOLVER

MODEL	CODE	CALIBER	ACTION	BARREL	FINISH
STAMPEDE	JEA1401	.45 COLT	SINGLE	4¾"	BLUE
STAMPEDE	JEA1403	.357 MAG	SINGLE	4¾"	BLUE
STAMPEDE	JEA1501	.45 COLT	SINGLE	5½"	BLUE
STAMPEDE	JEA1503	.357 MAG	SINGLE	5½"	BLUE
STAMPEDE	JEA1701	.45 COLT	SINGLE	7½"	BLUE
STAMPEDE, NICKEL	JEB1401	.45 COLT	SINGLE	4¾"	NICKEL
STAMPEDE, NICKEL	JEB1501	.45 COLT	SINGLE	5½"	NICKEL
STAMPEDE, NICKEL	JEB1701	.45 COLT	SINGLE	7½"	NICKEL
STAMPEDE, DELUXE	JEC1401	.45 COLT	SINGLE	4¾"	CHARCOAL BLUE, BERETTA COLOR-CASE
STAMPEDE, DELUXE	JEC1403	.357 MAG	SINGLE	4¾"	CHARCOAL BLUE, BERETTA COLOR-CASE
STAMPEDE, DELUXE	JEC1501	.45 COLT	SINGLE	5½"	CHARCOAL BLUE, BERETTA COLOR-CASE
STAMPEDE, DELUXE	JEC1503	.357 MAG	SINGLE	5½"	CHARCOAL BLUE, BERETTA COLOR-CASE
STAMPEDE, DELUXE	JEC1701	.45 COLT	SINGLE	7½"	CHARCOAL BLUE, BERETTA COLOR-CASE
STAMPEDE "MARSHALL" OLD WEST	JEJ1301	.45 COLT	SINGLE	3½"	OLD WEST
STAMPEDE "MARSHALL"	JEE1401	.45 COLT	SINGLE	3½"	BERETTA COLOR-CASE
STAMPEDE "MARSHALL"	JEE1403	.357 COLT	SINGLE	3½"	BERETTA COLOR-CASE
STAMPEDE BISLEY	JEF1401	.45 COLT	SINGLE	4¾"	BLUE
STAMPEDE BISLEY	JEF1501	.45 COLT	SINGLE	5½"	BLUE
STAMPEDE BISLEY, NICKEL	JEF2401	.45 COLT	SINGLE	4¾"	NICKEL
STAMPEDE BISLEY, NICKEL	JEF2501	.45 COLT	SINGLE	5½"	NICKEL
STAMPEDE GEMINI	JEG4501R	.45 COLT	SINGLE	5½"	BLUE
STAMPEDE GEMINI	JEG4501L	.45 COLT	SINGLE	5½"	BLUE
STAMPEDE PHILADELPHIA	JEG3501B	.45 COLT	SINGLE	5½"	CHARCOAL BLUE, BERETTA COLOR-CASE
STAMPEDE PHILADELPHIA	JEG3502B	.45 COLT	SINGLE	5½"	CHARCOAL BLUE, BERETTA COLOR-CASE
STAMPEDE BUNTLINE	JEH1801	.45 COLT	SINGLE	18"	BLUE
STAMPEDE OLD WEST	JEJ1401	.45 COLT	SINGLE	4¾"	OLD WEST
STAMPEDE OLD WEST	JEJ1403	.357 MAG	SINGLE	4¾"	OLD WEST
STAMPEDE OLD WEST	JEJ1501	.45 COLT	SINGLE	5½"	OLD WEST
STAMPEDE OLD WEST	JEJ1503	.357 MAG	SINGLE	5½"	OLD WEST



# BERETTA FIREARMS INDEX

## STAMPEDE REVOLVER (CONTINUED)

MODEL	CODE	CALIBER	ACTION	BARREL	FINISH
LARAMIE	JFA1501	.45 COLT	SINGLE	5"	BLUE
LARAMIE	JFA1504	.38SP	SINGLE	5"	BLUE
LARAMIE, NICKEL	JFB1501	.45 COLT	SINGLE	5"	NICKEL
LARAMIE, NICKEL	JFB1601	.45 COLT	SINGLE	6 1/2"	NICKEL
LARAMIE, NICKEL	JFB1504	.38SP	SINGLE	5"	NICKEL
LARAMIE, NICKEL	JFB1604	.38SP	SINGLE	6 1/2"	NICKEL
GOLD RUSH CARBINE	JHA1A01	.45 COLT	PUMP	20"	BERETTA COLOR-CASE
GOLD RUSH CARBINE	JHA1A03	.357 MAG	PUMP	20"	BERETTA COLOR-CASE
GOLD RUSH RIFLE	JHA1B01	.45 COLT	PUMP	24 1/4"	BERETTA COLOR-CASE
GOLD RUSH RIFLE	JHA1B03	.357 MAG	PUMP	24 1/4"	BERETTA COLOR-CASE
GOLD RUSH DELUXE CARBINE	JHB1A01	.45 COLT	PUMP	20"	BERETTA COLOR-CASE, CHARCOAL BLUE
GOLD RUSH DELUXE RIFLE	JHB1B01	.45 COLT	PUMP	24 1/4"	BERETTA COLOR-CASE, CHARCOAL BLUE
1873 RENEGADE SHORT RIFLE	JNA1A01	.45 COLT	LEVER	20"	BLUE
1873 RENEGADE SHORT RIFLE	JNA1A03	.357 MAG	LEVER	20"	BLUE

## PISTOLS AND HOME PROTECTION

### U22 NEOS

MODEL	CODE	CALIBER	ACTION	SIGHT/GRIPS	ROUNDS
U22 NEOS 4.5	JU2S45B	.22LR	SINGLE	TARGET/ POLYMER	10 ROUNDS
U22 NEOS 4.5 INOX	JU2S45X	.22LR	SINGLE	TARGET/ POLYMER	10 ROUNDS
U22 NEOS 6.0	JU2S60B	.22LR	SINGLE	TARGET/ POLYMER	10 ROUNDS
U22 NEOS 6.0 INOX	JU2S60X	.22LR	SINGLE	TARGET/ POLYMER	10 ROUNDS
U22 NEOS 6.0 DLX	JUDS60B	.22LR	SINGLE	TARGET/POLYMER W/INLAYS	10 ROUNDS
U22 NEOS 6.0 INOX DLX	JUDS60X	.22LR	SINGLE	TARGET/POLYMER W/INLAYS	10 ROUNDS

### 90 SERIES

MODEL	CODE	CALIBER	ACTION	FINISH/GRIP	ROUNDS
M9	J92M9A0M	9MM	DBL/SNGL	PLASTIC	15 ROUNDS
M9	J92M9A0	9MM	DBL/SNGL	PLASTIC	10 ROUNDS
92FS	J92F300M	9MM	DBL/SNGL	3 DOT/PLASTIC	15 ROUNDS
92FS	J92F300	9MM	DBL/SNGL	3 DOT/PLASTIC	10 ROUNDS
92FS INOX	JS92F500	9MM	DBL/SNGL	STAINLESS/PLASTIC	15 ROUNDS
92FS INOX	JS92F500	9MM	DBL/SNGL	STAINLESS/PLASTIC	10 ROUNDS



# BERETTA FIREARMS INDEX

## 90 SERIES (CONTINUED)

MODEL	CODE	CALIBER	ACTION	FINISH/GRIP	ROUNDS
<b>M9A1</b>	J592M9A1M	9MM	DBL/SNGL	PLASTIC	15 ROUNDS
<b>M9A1</b>	J592M9A1	9MM	DBL/SNGL	PLASTIC	10 ROUNDS

## PX4 STORM

MODEL	CODE	CALIBER	ACTION	FINISH/GRIP	ROUNDS
<b>PX4 STORM TYPE F SUB-COMPACT</b>	JXS9F21	9MM	DBL/SGL	MATTE/PLASTIC	13 ROUNDS
<b>PX4 STORM TYPE F SUB-COMPACT</b>	JXS4F20	.40 S&W	DBL/SGL	MATTE/PLASTIC	10 ROUNDS
<b>PX4 STORM TYPE F FULL SIZE</b>	JXF9F21	9MM	DBL/SGL	MATTE/PLASTIC	17 ROUNDS
<b>PX4 STORM TYPE F FULL SIZE</b>	JXF9F20	9MM	DBL/SGL	MATTE/PLASTIC	10 ROUNDS
<b>PX4 STORM TYPE F FULL SIZE</b>	JXF4F21	.40 S&W	DBL/SGL	MATTE/PLASTIC	14 ROUNDS
<b>PX4 STORM TYPE F FULL SIZE</b>	JXF4F20	.40 S&W	DBL/SGL	MATTE/PLASTIC	10 ROUNDS
<b>PX4 STORM TYPE C FULL SIZE</b>	JXF9C21	9MM	CONSTANT	MATTE/PLASTIC	17 ROUNDS
<b>PX4 STORM TYPE C FULL SIZE</b>	JXF9C20	9MM	CONSTANT	MATTE/PLASTIC	10 ROUNDS
<b>PX4 STORM TYPE C FULL SIZE</b>	JXF4C21	.40 S&W	CONSTANT	MATTE/PLASTIC	14 ROUNDS
<b>PX4 STORM TYPE C FULL SIZE</b>	JXF4C20	.40 S&W	CONSTANT	MATTE/PLASTIC	10 ROUNDS
<b>PX4 STORM TYPE D FULL SIZE</b>	JXF9D21	9MM	DOUBLE	MATTE/PLASTIC	17 ROUNDS
<b>PX4 STORM TYPE D FULL SIZE</b>	JXF9D20	9MM	DOUBLE	MATTE/PLASTIC	10 ROUNDS
<b>PX4 STORM TYPE D FULL SIZE</b>	JXF4D21	.40 S&W	DOUBLE	MATTE/PLASTIC	14 ROUNDS
<b>PX4 STORM TYPE D FULL SIZE</b>	JXF4D20	.40 S&W	DOUBLE	MATTE/PLASTIC	10 ROUNDS
<b>PX4 STORM TYPE G FULL SIZE</b>	JXF9G21	9MM	DBL/SGL- NO MAN. SAFETY	MATTE/PLASTIC	17 ROUNDS
<b>PX4 STORM TYPE G FULL SIZE</b>	JXF9G20	9MM	DBL/SGL- NO MAN. SAFETY	MATTE/PLASTIC	10 ROUNDS
<b>PX4 STORM TYPE G FULL SIZE</b>	JXF4G21	.40 S&W	DBL/SGL- NO MAN. SAFETY	MATTE/PLASTIC	14 ROUNDS
<b>PX4 STORM TYPE G FULL SIZE</b>	JXF4F20	.40 S&W	DBL/SGL- NO MAN. SAFETY	MATTE/PLASTIC	10 ROUNDS
<b>PX4 STORM TYPE F FULL SIZE</b>	JXF5F25	.45 ACP	DBL/SGL	MATTE/PLASTIC	9 AND 10 ROUNDS
<b>PX4 STORM TYPE F SPECIAL DUTY</b>	JXF5F45	.45 ACP	DBL/SGL	MATTE/PLASTIC	9 AND 10 ROUNDS

## 90 TWO

MODEL	CODE	CALIBER	ACTION	FINISH/GRIP	ROUNDS
<b>90 TWO TYPE F</b>	J9T9F11	9MM	DBL/SNGL	MATTE/PLASTIC	17 ROUNDS
<b>90 TWO TYPE F</b>	J9T9F10	9MM	DBL/SNGL	MATTE/PLASTIC	10 ROUNDS
<b>90 TWO TYPE F</b>	J9T4F11	.40 S&W	DBL/SNGL	MATTE/PLASTIC	12 ROUNDS
<b>90 TWO TYPE F</b>	J9T4F10	.40 S&W	DBL/SNGL	MATTE/PLASTIC	10 ROUNDS



# BERETTA FIREARMS INDEX

## 80 CHEETAH SERIES

MODEL	CODE	CALIBER	ACTION	FINISH/GRIP	ROUNDS
<b>84 CHEETAH</b>	J84F200M	.380 AUTO	DBL/SNGL	BRUNITON/PLASTIC	13 ROUNDS
<b>84 CHEETAH</b>	J84F200	.380 AUTO	DBL/SNGL	BRUNITON/PLASTIC	10 ROUNDS
<b>84FS CHEETAH NICKEL</b>	J84F212M	.380 AUTO	DBL/SNGL	NICKEL/WOOD	13 ROUNDS
<b>84FS CHEETAH NICKEL</b>	J84F212	.380 AUTO	DBL/SNGL	NICKEL/WOOD	10 ROUNDS
<b>85 CHEETAH</b>	J85F200	.380 AUTO	DBL/SNGL	BRUNITON/PLASTIC	8 ROUNDS
<b>85FS CHEETAH NICKEL</b>	J85F212	.380 AUTO	DBL/SNGL	NICKEL/WOOD	8 ROUNDS
<b>87 CHEETAH</b>	J87B210	22LR	DBL/SNGL	BRUNITON/ WOOD	7 ROUNDS

CODE	CHOKES INCLUDED	DESCRIPTION	APPLICABILITY	NOTES
MC2	M-IC	MOBILCHOKE 2	390	MODIFIED FROM F-M CONSTRICTIONS
MC3	F-M-IC	MOBILCHOKE 3	390I, ES100, BLACKWING, WHITEWING	
MC6	F-IM-M-IC-SK-SK	MOBILCHOKE 6	687EELL DIAMOND PIGEON SKEET	
MCF	F-IM-M-IC-C	MOBILCHOKE FIELD	AL391 URIKA (20G), AL391 TEKNYS (20G), ONYX SERIES, SILVER PIGEON S, SILVER PIGEON II, III, IV AND V, EL GOLD PIGEON II, EELL DIAMOND PIGEON, ULTRALIGHT, EL GOLD PIGEON II SPTG (20,28, 410G), EELL DIAMOND PIGEON SPTG (20,28, 410G), 471 SILVER HAWK (20G), 470EL (20G)	
MCS	F-IM-M-IC-SK	MOBILCHOKE SPORT	AL391 URIKA SPORTING (20G), AL391 TEKNYS SPORTING (20G)	
MCS2	IM-M-IC-C-SK	MOBILCHOKE SPORT 2	686 E SPORTING, 687 SILVER PIGEON II SPORTING (20&28G)	
OBF	F-IM-M-IC-C	OPTIMA-BORE FIELD	A391 XTREMA 3.5, A391 XTREMA2 3.5, AL391 URIKA (12G), AL391 TEKNYS (12G), EL GOLD PIGEON II SPTG (12G), SILVER PIGEON III SPORTING (12G), EELL DIAMOND PIGEON SPTG (12G)	
OBS	F-IM-M-IC-SK	OPTIMA-BORE SPORT	AL391 URIKA COMPETITION(12); AL391 TEKNYS SPORTING (12G)	
OBSF	IM-M-IC-C-SK	OPTIMA-BORE SPORTING	DT10 TRIDENT SPORTING, 682 GOLD E SPORTING, 687 SILVER PIGEON II SPORTING (12G), WHITE ONYX SPORTING (12G)	
OBSK	IM-M-IC-SK-SK	OPTIMA-BORE SKEET	DT10 TRIDENT SKEET, 682 GOLD E SKEET	
OBTR	F-F-IM-M-IC	OPTIMA-BORE TRAP	DT10 TRIDENT TRAP, 682 GOLD E TRAP	
OBT5	F-IM-M	OPTIMA-BORE TRAP SINGLE	DT10 TRIDENT TRAP SINGLE	
OCF	F-IM-M-IC-C	OPTIMA-CHOKE FIELD	471 SILVER HAWK (12G), 471 EL (12G)	OPTIMA-CHOKE TUBES ON MOBILCHOKE BARREL







17601 Beretta Drive  
Accokeek, MD 20607  
800-BERETTA (800-237-3882)

[WWW.BERETTA.COM](http://WWW.BERETTA.COM)