

FOR HUNTING



**FOR SECURITY &
HOME DEFENSE**

FOR LAW ENFORCEMENT

FOR COMPETITION

BUSHMASTER FIREARMS

www.bushmaster.com

Telephone Orders 24 Hours: **1-800-998-7928**

Fax Orders: **1-207-892-8068**

Customer Service: **1-800-883-6229**

Bushmaster Firearms International, LLC • 999 Roosevelt Trail • P.O. Box 1479 • Windham, Maine 04062 • U.S.A.

New
Bushmaster
O.R.C.
[Optics Ready Carbine]



Table of Contents:



- 1** Bushmaster - For Hunting
- 4** Bushmaster - For Security & Home Defense
- 8** Bushmaster - For Law Enforcement
- 11** Bushmaster - For Competition
- 13** Bushmaster - For Plinking
- 14** Carbon 15 Accessories
- 15** Bushmaster Receivers & Parts
- 22** Competition Parts & Accessories
- 24** Upper Receiver/Barrel Assemblies
- 31** Bushmaster Barrels
- 36** Handguards & Accessories
- 40** Parts Reference Schematic
- 42** Order Forms / Exchanges / Warranty, etc.
- 46** Muzzle Brakes & Flash Suppressors
- 48** Pistol Grips & Buttstocks
- 52** Magazines & Accessories
- 56** Slings & Bipods
- 58** Gunsmithing Tools & Supplies
- 64** Sights, Scopes & Mounts
- 73** Bushmaster Modular Accessories System
- 78** Bushmaster Apparel & Accessories
- 81** Bushmaster Gift Certificates

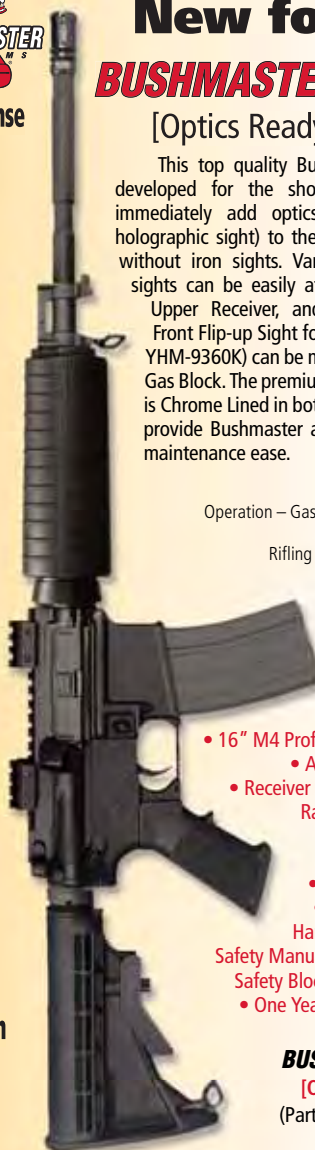

New for 2007

BUSHMASTER O.R.C.[®]

[Optics Ready Carbine]

This top quality Bushmaster Carbine was developed for the shooter who intends to immediately add optics (scope, red dot or holographic sight) to the rifle - as it is shipped without iron sights. Various add-on rear iron sights can be easily attached to the flat-top Upper Receiver, and Bushmaster's BMAS Front Flip-up Sight for V Match Rifles (Part # YHM-9360K) can be mounted over the Milled Gas Block. The premium 16" M4 Profile Barrel is Chrome Lined in both Bore and Chamber to provide Bushmaster accuracy, durability and maintenance ease.

Specifications

Operation - Gas Operated/Semi-Automatic
Mag. Capacity - 30 Rds
Rifling - R.H. Twist - 1 turn in 9"
Overall Length - 36.25"
Barrel Length - 16"
Weight w/o Mag. - 6 lbs.

- 5.56mm / .223 Remington Caliber
- 16" M4 Profile Chrome Lined Barrel
- A2 Bird Cage Suppressor
- Receiver Length Picatinny Optics Rail w. 1/2" Optics Risers
 - Milled Gas Block
 - Oval M4 Type Forend
 - Six Position Tele-Stock
 - Shipped in a Lockable Hard Case with Operator's Safety Manual, 30 Round Magazine, Safety Block and Black Web Sling
- One Year Bushmaster Warranty

BUSHMASTER O.R.C.[®]

[Optics Ready Carbine]

(Part #BCWWMF 16M4ORC)

M.S.R.P. **\$1085.00**

BUSHMASTER... The Best. By a Long Shot!

On the Internet at:
www.bushmaster.com

1 800 998 7928

E-mail Directory: Info@bushmaster.com
Customer service@bushmaster.com
Export@bushmaster.com

Letters/Correspondence to:
Ship All Packages to:

P.O. Box 1479 / Windham, Maine 04062 U.S.A.
999 Roosevelt Trail / Windham, Maine 04062 U.S.A.



Orders by FAX: 207-892-8068

LE@bushmaster.com
Techsupport@bushmaster.com
Webmaster@bushmaster.com

Major Credit Cards Accepted





FOR HUNTING

The Bushmaster Predator

...built as a result of numerous requests by the hunters who wanted a slightly shorter barrel and lighter swing weight in a carry rifle for predator hunting/calling, this 20" barreled version of the Varminter below will deliver all the accuracy you've come to expect from a Bushmaster.

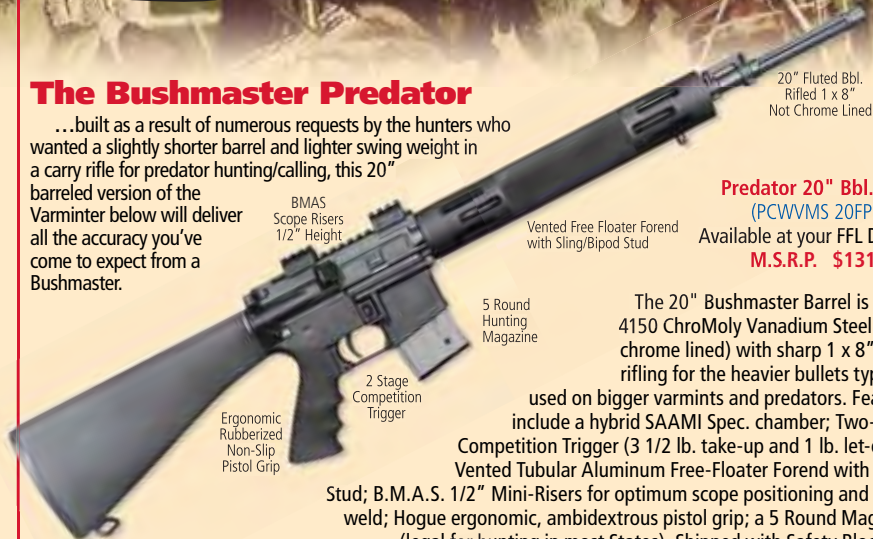

20" Fluted Bbl.
Rifled 1 x 8"
Not Chrome Lined

Predator 20" Bbl. Rifle
(PCWVMS 20FPRED8)
Available at your FFL Dealer
M.S.R.P. \$1310.00

BMAS
Scope Risers
1/2" Height

Vented Free Floater Forend
with Sling/Bipod Stud

5 Round
Hunting
Magazine

2 Stage
Competition
Trigger

Ergonomic
Rubberized
Non-Slip
Pistol Grip

The 20" Bushmaster Barrel is fluted 4150 Chromoly Vanadium Steel (non-chrome lined) with sharp 1 x 8" twist rifling for the heavier bullets typically used on bigger varmints and predators. Features include a hybrid SAAMI Spec. chamber; Two-Stage Competition Trigger (3 1/2 lb. take-up and 1 lb. let-off); a Vented Tubular Aluminum Free-Floater Forend with Bipod Stud; B.M.A.S. 1/2" Mini-Risers for optimum scope positioning and cheek weld; Hogue ergonomic, ambidextrous pistol grip; a 5 Round Magazine (legal for hunting in most States). Shipped with Safety Block and Operator's Manual in a Lockable, Foam Padded, Hard Case.

Specifications:

Caliber 5.56 mm / .223 Rem.
Overall Length 38.25 inches
Weight w/o Mag. 8 Lbs.
Gas Operated Semi-Automatic



Carrying Case included...\$18.95 Value

All Bushmaster Rifles are shipped in a lockable, foam padded, hard pastic carrying case.

The Bushmaster Varminter

...includes all the options a varmint hunting specialist would order in a custom rifle... The Varminter delivers long distance accuracy, quick second shots, and Bushmaster reliability – the perfect prairie dog rifle.

Varminter 24" Bbl. Rifle
(PCWVMS 24FVAR9)
Available at your FFL Dealer
M.S.R.P. \$1325.00



24" Fluted Bbl.
Rifled 1 x 9"
Not Chrome Lined

Specifications:

Caliber 5.56 mm / .223 Rem.
Overall Length 42.25 inches
Weight w/o Mag. 8.4 Lbs.
Gas Operated Semi-Automatic

Vented Free Floater Forend
with Sling/Bipod Stud

Featuring:

- 5.56mm / .223 Rem. Caliber, 24" Fluted Extra Heavy (1" diam. out to the gas block) Bushmaster Varminter Barrel with 11" competition crowned muzzle - 1 in 9" twist
- Barrel is 4150 Chromoly Vanadium Steel with a hybrid SAAMI Spec. chamber (longer throat or "Leade" for 5.56mm ammo - equally safe for use with .223 ammo)
- Competition Two-Stage Trigger - 1st Stage 3 1/2 lb. / Letoff 1 lb.
- Vented Tubular Forend free-floats the barrel from the receiver forward - with cooling vents to increase barrel heat dissipation
- Bipod Stud installed for easy mounting of most bipods or a sling
- Shipped with 5 Round Magazine (legal for hunting in most states), Safety Block, Operator's Manual and Special Maintenance Instructions in a Bushmaster Lockable, Foam Padded, Hard Case

5 Round
Hunting
Magazine

2 Stage
Competition
Trigger

Ergonomic
Rubberized
Non-Slip
Pistol Grip

FOR HUNTING



Bushmaster Stainless Varmint Special

...Based upon the design of our first Varminter, the "Stainless Varmint Special" combines all the essentials for serious varmint hunting – including a polished, 416 Stainless Steel, 5.56mm/.223 Rem. Caliber 24" Barrel (button rifled, 1 in 9" right hand twist).

Stainless Varminter Special Rifle

(PCWVMS 24-9SS)

Available at your FFL Dealer

M.S.R.P. \$1325.00



24" 416 Stainless Steel Barrel Riffled 1 x 9

Specifications:

Caliber 5.56 mm / .223 Rem.
Overall Length 42.25 inches
Barrel Length 24" - Rifling 1 x 9"
Weight w/o Mag. 8.84 Lbs.
Gas Operated Semi-Automatic

Featuring:

- Vented Free-floater Aluminum Forend with Bipod/Sling Mount Stud installed
- Two 1/2" Height Bushmaster Modular Accessories Scope Riser Blocks
- Adjustable Palm Swell Tactical Pistol Grip for shooting comfort and correct trigger pull angle
- Competition 2-Stage Trigger - 1st Stage 3 1/2 lb./Letoff 1 lb.
- A2 Buttstock complete with trapdoor storage compartment
- Shipped with Five Round Magazine (accepts all capacity AR15/M16 type magazines), Safety Block, Operator's Manual in a Lockable Case.

Vented Free Floater Forend with Sling/Bipod Stud

BMAS Scope Risers 1/2" Height

5 Round Hunting Magazine

2 Stage Competition Trigger

Palm Swell Adjustable Pistol Grip

For "Little Varmints"... The Carbon 15 .22LR Rimfire

M.S.R.P. \$790.00 (AZ-C1522LR)

Available at FFL Dealers



See Carbon 15 Accessories for Youth Buttstock

Specifications:

Caliber .22 Long Rifle Rimfire
Magazine Capacity 10 Rounds
Overall Length 33"
Barrel Length 16" Riffled 1 x 16" R.H.
Weight w/o magazine 4.1 lbs.
Mode of Operation Blowback / Semi-Auto

The Bushmaster Carbon 15 .22LR Rimfire Rifle is designed to feel and function like

Bushmaster's traditional 5.56mm/.223 caliber models, but is chambered for the economical .22 Long Rifle.

Features: • Receivers, Buttstock and Charging Handle molded of Carbon Fiber composite • Operational controls functionally and ergonomically identical to all AR15 type rifles – ideal for developing skills with the AR15 type system - .22 Rimfire ammunition is acceptable for use in indoor ranges • Highly accurate 16" Chromoly Barrel • Dual Aperture Rear Sight / Square Post Front Sight • Receiver-length Picatinny Rail for easy scope, optic, red dot or laser sight mounting • Safety Selector Lever markings on both sides of the Lower Receiver • Shipped with 10 Round Magazine, Operator's Manual, Lockable, Carrying Case - Bushmaster One Year Warranty

Carbon 15 .22 LR Rimfire Receiver/Barrel Assembly... A semi-automatic blowback operation, dedicated .22 Rimfire Upper Assembly for Bushmaster and other "mil. spec." Lower Receivers. Sharpen your skills with economical .22LR ammo - acceptable at most indoor ranges. Complete kit includes all pieces necessary to convert your rifle to .22 Rimfire (parts will combine to work with all types of stocks - tele included).



Carbon Fiber Receiver

16" Barrel



Aluminum Receiver

Full Length Handguards

A2 Iron Sights

20" Barrel

Carbon 15 .22LR Upper Rec./Bbl. Assy... \$387.00

Includes 10 Rd. Magazine and Adapters (AZ15846K)

Aluminum .22LR Upper Rec./Bbl. Assy... \$469.95

Includes 10 Rd. Magazine and Adapters (AZ15847K)



FOR HUNTING

Great Lightweight Carry/Calling Guns... Carbon 15 "Flat-top" Carbine and Carbon 15 R97F

Traditional .223 Caliber
Carbine Design with
Light Carbon 15 Receivers.

Six Position
Telescope

Flip-up
Rear Sight

Carbon Fiber
Upper & Lower
Receivers

Full Length
Picatinny Rail
with Integral
Rear Sight

Hogue
Grip

Six Position
Telescope

Ribbed
Forend Design

16" M4 Type Bbl.
Chrome Lined
1 x 9" Rifled

Carbon 15 "Flat-top" Carbine (AZ-C1516M4FT)

M.S.R.P. \$1155.00

- Weight 5.5 Lbs. / 37" Overall Length
- Izzy Compensator on threaded muzzle
- Receiver Length Flat-top Picatinny Rail
- Dual Aperture Flip-up Rear Sight / A2 Post Front Sight
 - Safety Controls Marked on Both Sides of Receiver
 - 30 Round Magazine

16" Fluted
Stainless Steel Bbl.
1 x 9" Rifled

Carbon 15 R97F Rifle (AZ-C15R97F)

M.S.R.P. \$1265.00

- Weight 4.5 Lbs. / 35" Overall Length
- A2 Birdcage Suppressor • Chrome Plated Bolt Carrier
 - Picatinny Optics Mounting Rail
 - Dual Aperture Rear / Blade Front Sight
 - Safety Controls Marked on Both Sides of Receiver
 - Forend Sling Stud installed • 30 Round Magazine

Available only through FFL Dealers

RealTree® Camouflage Furniture...

Add RealTree® Camouflage to your AR Type Rifle - perfect fitting, easy replacements for your carbine or rifle that are tank dipped in RealTree® Camouflage Pattern film. True to nature, tough and beautiful, these make a great addition to your hunting rifle. Sold individually or in Stock/Grip/Handguard Sets.

- RealTree® Camo Rifle Length Handguards (9349059-C) \$39.95
- A2 Std. Buttstock with RealTree® Camo (9349119-C) \$54.95
 - Std. Pistol Grip with RealTree® Camo (9349127-C) \$19.95
- RealTree® Camo CAR Handguards (1005-914-4572-C) \$29.95
- RealTree® Camo CAR Furniture SET (CAMO-RT-CAR) \$99.95
- RealTree® Camo Rifle Furniture SET (CAMO-RT-RIFLE) \$106.95

Desert Camo Furniture... These Desert Camouflage Pattern Buttstocks, Handguard Sets and Pistol Grips can be add-on accessories for your rifle or carbine. Highest quality - same as on our standard rifles and carbines - tank dipped in beautiful and durable Desert Camo Pattern film.

- Desert Camo Pistol Grip... (9349127-DC) \$19.95
- Desert Camo Trapdoor Buttstock... (9349119-DC) \$54.95
- Desert Camo CAR Handguards... (1005-914-4572-DC) \$29.95
- Desert Camo 3 Piece Set (all above)... (CAMO-DC-CAR) \$99.95

FOR SECURITY & HOME DEFENSE



Bushmaster Carbon 15 9MM Carbine & Pistol...

Bushmaster introduces the next generation of Carbon 15 models... now available in 9mm NATO caliber (9 x 19mm). With all the durability and light weight that Carbon Fiber construction can offer, these new firearms are ideal for Law Enforcement, personal protection and unique fun at the range. Their blowback system offers smooth Semi-Auto operation with low recoil, and their light weight makes carrying and target acquisition easy.



Made with Pride
in the U.S.A.

Bushmaster Carbon 15 9MM Pistol (AZ9-C15P21S) M.S.R.P. \$1025.00

- Carbon Fiber Composite Receivers
- Full Length Picatinny Optics Rail
- M203 Type Forend / Sling Studs
 - 7.25" ChroMoly Steel Barrel
 - A1 Birdcage Flash Hider
 - Dual Aperture Rear Sight
 - A2 Square Post Front Sight
 - 30 Round Magazine
- Sound Reducing Neoprene Foam Sleeve over Buffer Tube
- Length - 22.75" Overall / Weight - 4.6 lbs. w/o Magazine

Bushmaster Carbon 15 9MM Carbine (AZ9-C15R16FT) M.S.R.P. \$1050.00

- Blow-back Operation • Carbon Fiber Composite Receivers
- Picatinny Optics Rail • 16" ChroMoly Steel Barrel with A1 Birdcage Flash Hider
- Dual Aperture Rear Sight / A2 Square Post Front Sight • Six-Position Telestock
- Length - 34.5" Overall / Weight - 5.7 lbs. w/o Magazine • 30 Round Magazine

Bushmaster SuperLight Carbines...

A3 Carbines include the Removable Carry Handle

Overall Length w. Tele - 34.5 inches
Overall Length w. Stubby - 31.25 inches
A2 Weight w/o Mag - Tele - 6.25 lbs.
A2 Weight w/o Mag - Stubby - 5.8 lbs.

A3 SuperLight Carbine
with 6 Position TeleStock



Slim Profile
Barrels with either
6 Position TeleStock
or "Stubby Stock"

A2 SuperLight Carbine
with "Stubby" Stock

The Bushmaster SuperLight - our lightest 16" chrome lined barrel (.670" to .565" diam. under the handguard, .625" diam. under the sight base, and .570" diam. out to the muzzle), in combination with either the Six Position TeleStock or the "Stubby" Stock make a sweet handling, easy to shoot carbine.

- SuperLight A3 Carbine w. TeleStock... (BCWA3F 16SL) Available at FFL Dealers M.S.R.P. \$1215.00
- SuperLight A2 Carbine w. TeleStock... (BCWA2F 16SL) Available at FFL Dealers M.S.R.P. \$1130.00
- SuperLight A3 Carbine w. Stubby Stock... (BCWA3Y 16SL) Available at FFL Dealers M.S.R.P. \$1190.00
- SuperLight A2 Carbine w. Stubby Stock... (BCWA2Y 16SL) Available at FFL Dealers M.S.R.P. \$1105.00

Most Bushmaster Carbines are available in kit form - including all parts except the stripped lower. Many options are available - consult your Bushmaster salesperson. Receivers must be purchased from an FFL Dealer.



FOR SECURITY & HOME DEFENSE

Bushmaster Carbon 15 Pistols...

These unique Handguns... utilize the same Carbon Fiber composite technology and rugged features as the Bushmaster Carbon 15 Rifles – resulting in incredibly light, durable, and power-packed 5.56mm / .223 cal. pistols.



High Tech Carbon Fiber Molded Receivers and Components

Gas Operated Semi-Automatic 5.56mm/.223 Rem. Stainless Steel Barrels

All Pistols are 20" Overall Length Weights without Magazine or Compensator: 47 to 55 ozs.

Carbon 15 Type 97S Pistol (AZ-C15P97S) M.S.R.P. \$1095.00

- 7.25" 416 Match Grade Stainless Steel Barrel Rifled 1 x 9 w. Birdcage Flash Suppressor
- Dual Aperture Rear Flip-up and Blade Front Sights
- Chromed Bolt Carrier • Hogue® OverMolded™ Pistol Grip
- Full Length Optics Rail & Lower Accessory Rail • 30 Rd. Magazine

Carbon 15 Type 21S Pistol (AZ-C15P21S) M.S.R.P. \$1050.00

- 7.25" 416 Match Grade Stainless Steel Barrel
- Birdcage Suppressor • Black Oxide Bolt Carrier
- Dual Aperture Rear Flip-up and Blade Front Sights
- Studs for Quick Detach Sling Swivel
- Full Length Picatinny Optics Rail • 30 Rd. Magazine

Carbon 15 Type 97 Pistol (AZ-C15P97) M.S.R.P. \$990.00

- 7.25" 416 Match Grade Stainless Steel Barrel Rifled 1 x 9 w. Quick Detach Compensator
- Hogue® OverMolded™ Pistol Grip • Chrome Plated Bolt Carrier
- Ghost Ring Rear and Blade Front Sights • 30 Round Magazine

Bushmaster Conversion Kit to Upgrade C15 P21/P97 Pistols to P21S Configuration (AZ15921S) \$159.95

Includes all parts to convert older pistols to new "handguard style" (like P21S above). Anodized Aluminum Rail with Dual Aperture Rear and Blade Front Sights; Carbon 15 Forend; Handguard Retainers; Gas Block; Sling Studs and Screws, Nuts, Pins. Due to necessary machining / tapping, this kit requires factory installation.

Oval P21S Handguard Kit (AZ15921) \$69.95

Includes Oval Carbon 15 Handguard, Handguard Retainers; Gas Block; Screws and O-Rings (all parts shown at left except Rail - factory installation required).

Lower Accessory Rail for Pistol Forends (AZ15695) \$52.95

Makes a P21S into a P97S - Rail shown in Carbon 15 Accessories Section.

Bushmaster Carbon 15 R21 Rifle...

Bushmaster's Lightest Rifle - molded of Tough Carbon 15 Composite...

An incredibly durable material - 40% stronger - 40% lighter than aircraft aluminum - impervious to moisture or corrosion - requires no surface finish.



Weight - 4 Lbs. / Overall Length 35"

Carbon 15 R21 Rifle (AZ-C15R21)

M.S.R.P. \$990.00

- 16" Stainless Steel Match Grade Barrel - 1 x 9 twist
- Quick Detach Compensator • Black Oxide Bolt Carrier
- Receiver Length Picatinny Optics Mounting Rail
- Safety Controls Marked on Both Sides of Receiver
- Shipped with 30 Round Magazine, Sling, Operation & Safety Manual - One Year Warranty

Newly Reinforced Buttstock Design

Youth Stock available - see Carbon 15 Accessories

New Ribbed Forend

Carrying Case included...\$18.95 Value

All Bushmaster Rifles are shipped in this lockable, foam padded Bushmaster case

Bushmaster Warranty... We back the superior quality and durability of all fine Bushmaster firearms with a One Year Warranty against defects in materials and workmanship.

Security / Home Defense

5

Orders 24 Hrs.: 1 800 998 7928

FOR SECURITY & HOME DEFENSE



Bushmaster Modular Carbines...

Bushmaster's 16" Bbl. Modular Carbines combine many of the most popular items from the Bushmaster Modular Accessories System (B.M.A.S.) into a completely unique firearm. Designed around an A3 type "flat-top" Upper, the Modular Carbine has a 16" Chrome Lined, Fluted Barrel with Milled Gas Block.



16" Fluted Barrels - Chrome Lined in Bore & Chamber with A2 Birdcage Suppressor

Specifications:

Caliber 5.56mm / .223 Rem.
Overall Length 34.5" [87.63 cm]
Barrel Length 16" [40.64 cm]
Rifling 1 turn in 9" R.H. twist
Weight w/o mag. 7.3 lbs. [3.31 kg]

The Modular Carbine can be configured with either a Bushmaster 6 Position Telescop or the Ace Skeleton Stock – which features a comfortable rubber buttplate; quick detach sling swivel mount for positioning on left or right side of the carbine; a neoprene foam sleeve covering the

buffer tube for good cheek weld (it also deadens the operational sounds of the buffer/action spring). A B.M.A.S. Four Rail Free-Floater Forend combined with the A3 type "flat-top" Upper Receiver provide all the Picatinny rails necessary for sights, scopes or accessories. Molded Rubber Sure Grips snap over the rail sections to add comfort and rail protection. The Dual Aperture B.M.A.S. Rear Flip-up Sight is a detachable unit with a windage knob calibrated to 1/2 Minute of Adjustment. The B.M.A.S. Front Flip-up Sight clamps around the milled gas block, and an ergonomically contoured Pistol Grip completes this special carbine.

Shipped with a 30 Rd. Mag., Operating & Safety Manual, Safety Block, and Sling in a lockable carrying case.

- **Modular Carbine w. 6 Position Tele (BCWVMF 16FMC)** Available from your FFL Dealer **M.S.R.P. \$1745.00**
- **Modular Carbine w. Skeleton Stock (BCWVML 16FMC)** Available from your FFL Dealer **M.S.R.P. \$1745.00**

Bushmaster 11.5" Bbl. Carbine w. 5.5" Suppressor...

This lightweight carbine features an 11.5" heavy barrel with a pinned and welded 5.5" CAR 15 Flash Suppressor attached. The total length of barrel/suppressor makes a legal length of 16" as required by ATF regulations.

Caliber: 5.56 mm / .223 Remington



- **A3 11.5" Bbl. / 5.5" Suppressed Carbine (BCWA3F 11.5/5.5)** M.S.R.P. **\$1215.00**
A3 Carbine includes Removable Carry Handle
- **A2 11.5" Bbl. / 5.5" Suppressed Carbine (BCWA2F 11.5/5.5)** M.S.R.P. **\$1130.00**

Bushmaster's six position telescop is fitted to either the A2 or A3 configurations, and a 30 Rd. magazine is supplied (accepts all AR-15/M16 type magazines). Standard

A2 sights are adjustable for elevation (1 M.o.A.) and windage (1/2 M.o.A.). On A3 configurations, the Removable Carry Handle is included (with 1/2 M.o.A. rear sight). The Bushmaster 11.5" Bbl. Carbine is shipped in a lockable carrying case with Safety Block, Web Sling, Operator's Safety and Instruction Manual.

Most Bushmaster Carbines are available in kit form - including all parts except the stripped lower.

Many options are available – consult your Bushmaster salesperson. Receivers must be purchased from an FFL Dealer.

FOR SECURITY & HOME DEFENSE



Bushmaster Dissipator Carbines...

The gas block in this versatile carbine is behind the front sight base, and under the handguards, to ensure correct gas pressure in the 16" carbine length barrel.

A2 Dissipator Carbine with Telestock

Full Length Forend for Full Sight Radius

A3 Models Include Removable Carry Handle

A3 Dissipator Carbine with Solid Stock

The full length rifle handguards offer excellent heat dissipation (hence the name), and placement of the front sight allows for optimal use of the full sight radius designed into the M16A2 sight system. The 16" heavy profile barrel is chrome lined in both bore and chamber for excellent accuracy and long life.

The Dissipator is available with either a Six Position Telestock or an A2 Solid Buttstock.

- Dissipator A3 16" Bbl. Carbine w. A2 Buttstock (BCWA3S 16D) From FFL Dealers **M.S.R.P. \$1205.00**
- Dissipator A2 16" Bbl. Carbine w. A2 Buttstock (BCWA2S 16D) From FFL Dealers **M.S.R.P. \$1120.00**
- Dissipator A3 16" Bbl. Carbine w. Telestock (BCWA3F 16D) From FFL Dealers **M.S.R.P. \$1230.00**
- Dissipator A2 16" Bbl. Carbine w. Telestock (BCWA2F 16D) From FFL Dealers **M.S.R.P. \$1145.00**

Overall Length w. TeleStock - 34.5" / A2 TeleStocked Weight w/o Mag - 7.44 lbs. / Overall Length w. A2 Stock - 34.75" / A2 Solid Stock Weight w/o Mag - 7.9 lbs.

Bushmaster "AK" Carbine...

AK A3 Carbine (not shown) includes Removable Carry Handle

AK A2 Carbine

Caliber: 5.56 mm / .223 Rem.

With permanently attached AK-47 type muzzle brake, overall barrel length of 17", this is an ATF legal semi-auto.



Shipped with 30 Rd. Mag Sling / Case / Operators Manual

- AK Carbine - A3 with Telestock (BCWA3F 14.5AK) Available from your FFL Dealer **M.S.R.P. \$1265.00**
- AK Carbine - A2 with Telestock... (BCWA2F 14.5AK) Available from your FFL Dealer **M.S.R.P. \$1180.00**

Overall Length - 35.25" / Weight w/o Mag - 7.56 lbs.

M4 Type "Post-Ban" Carbine...

- M4 Profile Barrel • Izzy Compensator • Fixed Length Stock • 10 Rd Mag.

- M4A3 Type Post-Ban Carbine (PCWA3X 14M4IZ) Available at your FFL Dealer **M.S.R.P. \$1265.00**
- M4A2 Type Post-Ban Carbine (PCWA2X 14M4IZ) Available at your FFL Dealer **M.S.R.P. \$1180.00**



M4A2 Type Shown here

BATF Approved, Fixed Position, Tele-Style Buttstock

10 Rd. Magazine

"Pre-Ban or Post-Ban"?... Most Bushmaster models are available in either configuration. "Pre-Ban" models (as manufactured prior the Federal Assault Weapons Ban of 1994) include High Capacity (30 Rd.) Magazine, Flash Suppressor, Bayonet Lug and possibly a Telestock. After the "sunset" of the Assault Weapons Ban in 2004, many States still have regulations prohibiting those "Assault Weapon Features". For those States, Bushmaster manufactures models in "Post-Ban" configurations. If in doubt about firearms configuration legalities in your State, consult your State Legislators, or a Bushmaster Salesperson.

FOR LAW ENFORCEMENT



NEW! Bushmaster Gas Piston Rifle...

Bushmaster incorporates an ultra reliable Gas Piston Operating System into this new Rifle - much like the systems on AK-47s and FALs. It functions with a wide range of ammunition - using less gas pressure and reduces required maintenance to the bare minimum.

5.56mm / .223 Caliber
16" M4 profile
Chrome Lined Barrel

Includes BMAS
Front Flip Sight

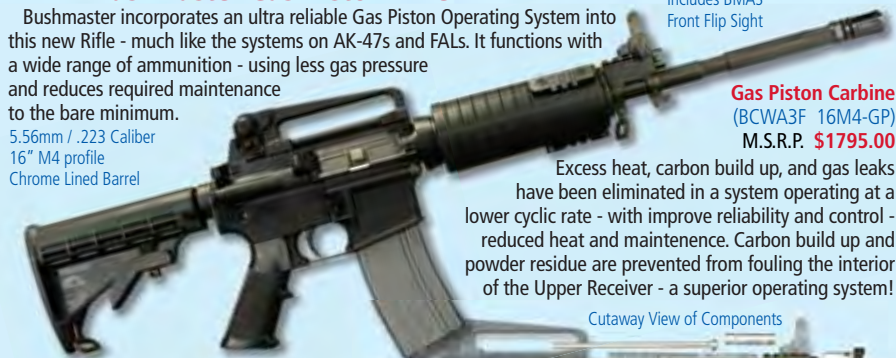

Gas Piston Carbine
(BCWA3F 16M4-GP)
M.S.R.P. **\$1795.00**

Excess heat, carbon build up, and gas leaks have been eliminated in a system operating at a lower cyclic rate - with improve reliability and control - reduced heat and maintenance. Carbon build up and powder residue are prevented from fouling the interior of the Upper Receiver - a superior operating system!

Cutaway View of Components

Also available - Gas Piston Uppers...

Snaps on to any Mil. Spec. Lower!



Bushmaster Gas Piston Operating System Upper Receiver/Barrel Assemblies are complete and ready to function with your Lower.

Bushmaster 5.56mm / .223 Rem. Caliber Complete Gas Piston Upper Receiver / Barrel Assemblies...

A3 Type w. Removable Carry Handle... (BURA3B 16M4-GP) **\$1095.00** / A2 Type... (BURA2B 16M4-GP) **\$995.00**

New! Bushmaster 6.8mm SPC Rifle...

• 16" M4 Profile Barrel • Six Position TeleStock • 6.8mm SPC 26 Rd. Mag.

This Gas Operated Semi-Auto packs a bigger punch than our 5.56mm/.223 models - a .270 cal. 6.8mm SPC ("Special Purpose Cartridge") punch specifically developed for the military, but now available commercially.

Velocity averages a bit over 2600 FPS (with Hornady 115 Gr.

V-Max), and the heavier bullet weights

deliver a terminal energy

capable of bringing down

larger game. Complete

Barreled Upper Receivers

with Magazine are also

available.

Cartridge
Comparison



Specifications:

Caliber 6.8mm SPC
Magazine 26 rounds
Length overall 34.75 inches
Barrel Length 16"
Rifling 1 x 10" R.H.
Weight w/o magazine 6.5 lbs.



6.8mm SPC Caliber Rifle w. Telestock

A3 Type (BCWA3F 16M468) M.S.R.P. **\$1295.00**

A2 Type (BCWA2F 16M468) M.S.R.P. **\$1195.00**

Available through your local FFL Dealer.

6.8mm SPC Upper Receiver/Barrel Assembly

A3 Type (BURA3B 16M468) **\$760.00**

A2 Type (BURA2B 16M468) **\$660.00**

Complete 6.8mm SPC Caliber
Upper Receiver/Barrel Assemblies
include 26 Rd. 6.8mm SPC Magazine

A3 Model
Includes
Removable
Carry Handle

A2 Models
with Solid
Carry Handle
also available.

FOR LAW ENFORCEMENT



Bushmaster M4 Type Carbines...

M4 Profile Barrel • Izzy Compensator/Flash Suppressor • Six Position TeleStock • 30 Rd. Magazine

M4A3 Carbine includes
A3 Removable Carry Handle

M4A3 Type Carbine

"Izzy" Compensator/Flash Suppressor



Specifications:

Mode of Operation: Semi-Automatic
Caliber: 5.56 mm / .223 Rem.
Barrel Length: 16" overall
Rifling: R.H. twist; 1 turn in 9"
Length (stock retracted): 30.875"
Weight w/o magazine: 6.22 Lbs.

Six Position Telestock

- **M4A3 Type Carbine w. Telestock (BCWA3F 14M4 IZ)**
Available from your FFL Dealer **M.S.R.P. \$1265.00**
- **M4A2 Type Carbine w. Telestock (BCWA2F 14M4 IZ)**
Available from your FFL Dealer **M.S.R.P. \$1160.00**

Other Stocks / Flash

Suppressors / Muzzle Brakes available

One of our most popular carbines, the Bushmaster M4 Type features a lightweight 14.5" Barrel machined in the distinctive M4 profile. With the "Sunset" of the 1994 A.W.B., we can now offer this model with a permanently attached (pinned and welded over) "Izzy" Compensator/Flash Suppressor, Six Position Telestock and High Capacity Magazine. This configuration yields a total barrel length of 16" to comply with BATF regulations for semi-automatic rifles. The barrel is chrome lined in both bore and chamber for longevity and easy cleaning, and the 1 x 9" twist button rifling will stabilize a wide range of currently available ammunition (bullet weights up to 75 grains). On the A2 Type, the M16A2 dual aperture, rear sight system offers both windage and elevation adjustments (calibrated from 300 to 800 meters).

The M4A3 Type Carbine includes a Removable Carry Handle with 1/2 Minute of Adjustment Rear Sight - calibrated from 300 to 600 meters. The Upper Receiver's full length Picatinny rail accepts a wide array of scopes, red dot sights, accessories, and night vision equipment. The Bushmaster M4 Carbine is shipped in a lockable case with 30 Round Magazine, Black Web Sling, Safety Block, and Operator's Safety and Instruction Manual.

Bushmaster M4 Type "Patrolman's" Carbine...

- 16" M4 Profile Barrel
- 6 Position TeleStock
- 30 Round Magazine
- A2 Birdcage Flash Suppressor

M4A3 Type Patrolman's
Carbine includes
A3 Removable Carry Handle

M4A3 Type Patrolman's Carbine



Six Position
Telestock

M4A2 Type Patrolman's Carbine

A2 "Birdcage"
Flash Suppressor

Overall Length - 36.25 inches
A2 Weight w/o Magazine - 6.35 lbs.

- **M4A3 Type Patrolman's Carbine (BCWA3F 16M4)**
Available from your FFL Dealer **M.S.R.P. \$1230.00**
- **M4A2 Type Patrolman's Carbine (BCWA2F 16M4)**
Available from your FFL Dealer **M.S.R.P. \$1125.00**

Alternate optional
buttstocks, flash suppressor
and compensators are available -
consult your Bushmaster Salesperson

Bushmaster's M4 Type Carbines are available in kit form - stripped lower receivers available at your FFL dealer.

FOR LAW ENFORCEMENT



Bushmaster 16" Heavy Barreled Carbine... One of our best selling LE Carbines

Alternate optional buttstocks are available – consult Bushmaster L.E. Sales

16" Hyv. A3 Carbine - Includes A3 Carry Handle

Specifications:



Full Auto and 3 Rd. Burst configurations are available. Consult Bushmaster L.E. Sales for detailed information

Caliber: 5.56 mm / .223 Rem.
Magazine: 30 rounds
Overall Length: 34.5" (87.63 cm)
Barrel Length: 16" (40.64 cm)
Rifling: R.H. twist; 1 turn in 9"
Weight w/o mag.: 7.16 Lbs. (3.25 kg)
Mode of Operation: Semi-Automatic

- 16" Bbl. A3 Carbine w. Telestock... (BCWA3F 16) Available from your FFL Dealer **M.S.R.P. \$1215.00**
- 16" Bbl. A2 Carbine w. Telestock... (BCWA2F 16) Available from your FFL Dealer **M.S.R.P. \$1130.00**

Bushmaster 11.5" Bbl. Entry Carbine...

Compact, powerful and well balanced, the Bushmaster Entry Carbine is designed for deployment from the Squad Car.

11.5" A3 Entry Carbine - Includes A3 Carry Handle

Specifications:

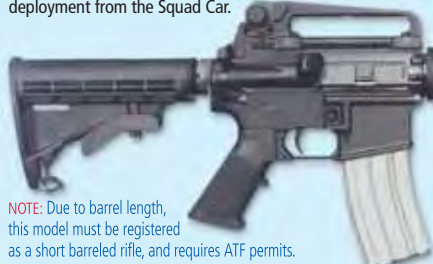

Full Auto and 3 Rd. Burst configurations are available. Consult Bushmaster L.E. Sales for detailed information

Caliber: 5.56 mm / .223 Rem.
Magazine: 30 rounds
Overall Length: 31.625" (80.34 cm)
Barrel Length: 11.5" (29.2 cm)
Rifling: R.H. twist; 1 turn in 9"
Weight w/o mag.: 6.81 Lbs. (3.09 kg)
Mode of Operation: Semi-Automatic

NOTE: Due to barrel length, this model must be registered as a short barreled rifle, and requires ATF permits.

- 11.5" Bbl. A3 Entry Carbine... (BCWA3F 11.5)
- 11.5" Bbl. A2 Entry Carbine... (BCWA2F 11.5)

Consult Bushmaster Law Enforcement Sales for Pricing

Bushmaster Law Enforcement Pistols... In both 5.56mm and 9mm calibers...

Lightweight and powerful - with molded Carbon 15 Receivers and familiar AR15 Type operational controls.

Specifications:

Carbon 15 9mm LE Pistol (AZ-BMP21S)

Fixed Sights on Full Length Optics Rail



Telestocks reduce overall length by 4" when collapsed

Flip Up Front & Rear Sights on Vented 4-Rail Forend

Caliber: 9mm (9 x 19 NATO)
Magazine: 30 Rds. (metal construction)
Overall Length: 22" (55.8 cm)
Barrel Length: 7.25" (18.42 cm) Rifled 1 x 10"
Weight w/o mag.: 4.8 Lbs. (2.2 kg)
Mode of Operation: Semi-Auto; Full Auto; 3 Shot Burst

Consult Bushmaster Law Enforcement Sales for Pricing



Carbon 15 5.56mm LE Pistol (AZ-C15BMP21SP4)

NOTE: Title II Receiver for Short Barreled Rifles, or Full Auto Models requires ATF approval.

Caliber: 5.56 mm / .223 Rem.
Magazine: 30 Rds. (accepts all M16/AR15 Type)
Overall Length: 22" (55.8 cm)
Barrel Length: 7.25" (18.42 cm) Rifled 1 x 9"
Weight w/o mag.: 5.1 Lbs. (2.31 kg)
Mode of Operation: Semi-Auto; Full Auto; 3 Shot Burst

Designed specifically for Law Enforcement and Military applications, the Bushmaster Carbon 15 Law Enforcement Pistols combine lightweight Carbon 15 molded Receivers, versatile Optics Rails, and Six Position Telestocks for compact carry size and maneuverability in tight confines.

BLACKWATER... Train with the Best... Bushmaster, through affiliation with Blackwater Training Center in Moyock, North Carolina, can offer top quality Armorer's Courses leading to Departmental Certification in the Bushmaster Weapons System. Blackwater also offers hands-on Carbine courses featuring Bushmaster products.



FOR COMPETITION



New... Bushmaster DCM-XR Competition Rifles

Bushmaster has re-designed this model to make the DCM Competition shooter more competitive - at a new lower price! These rifles includes the re-designed "Stay-Straight" Rear Sight and a Competition Rear Sight Shroud in addition to all the upgrades listed below.



New Bushmaster DCM-XR Series Competition Rifles with A2 Solid Carry Handle... \$1150.00 (PCWA2S 20DCM8)
with A3 Removable Carry Handle... \$1250.00 (PCWA3S 20DCM8)

No extra cost for threaded muzzle & birdcage suppressor (Change Part #s to BCWA2S or BCWA3S)

All prices M.S.R.P. - Available from your FFL Dealer

The Bushmaster DCM-XR Includes these Upgrades & Competition Modifications:

1 A2 Rear Sight includes a Competition Rear Sight Shroud / New design "Stay-Straight" windage adjustment mechanism with a dual detent keeps sight perfectly vertical (CMP approved) / Windage and Elevation available in either 1/2 or 1/4 Minute of Adjustment / Rear Flip Sight specially modified to accept interchangeable "micro-aperture" peeps / Micro-aperture inserts available in four sizes: .036" - .040" (standard, and most commonly selected by competition shooters) - .046" and .052" sizes. **Please specify when ordering.**

2 A Competition Front Sight Post specially ground on three sides for optimum visual clarity - available in your choice of two different widths (.052" or .062" width). **Please specify when ordering. Note: The post is secured within the Front Sight Base by a set screw to avoid the possibility of movement once you have established zero.**

3 A 20" Bushmaster Extra Heavy Competition Barrel - a full 1" in diameter under the handguard - with an 11° Crowned Competition Muzzle. Precision button rifled in a 1 x 8" right hand twist, they are machined from Chrome Moly Vanadium barrel steel, lapped and hardened to Rockwell C26 to 32 - superior to stainless barrels! With a hybrid custom match chambering that uses a tighter SAAMI Spec. headspace from the chamber shoulder to the bolt face, it has longer throat depth or "Leade" that will accommodate the higher pressure 5.56mm ammunition but .223 Rem. caliber can be safely used as well. DCM Rifles can be ordered with either the plain crowned competition muzzle or the A2 Birdcage Flash Suppressor. **Note: These barrels are shipped well oiled. For your safety, they must be cleaned before shooting. Follow all break-in and maintenance instructions included with your rifle.**

4 The forearm uses stock style outer handguards over a "free floater" tube that does not contact the barrel. A sling swivel is attached to the leading edge of the tube so as to avoid any possibility of barrel deflection when using a sling.

5 The Bolt is matched to the Barrel Extension for positive lockup and optimum accuracy.

6 "Controlled Ejection Path" - Ejection of spent cases from the Receiver has been engineered so as to drop them all in the same place - a great convenience for the reloader, and a courtesy to fellow competitors next to you on the line.

7 The Lower Receiver houses a finely honed Competition Trigger that is factory set for a DCM legal 4.5 lb. pull. The 1st Stage is 3.5 lbs., and the letoff (2nd Stage) is 1 lb.

8 The buttstock has been improved for competition with the addition of a 3.62 lb. lead counterbalancing weight which can be trimmed by the competitor to achieve proper balance, and adds to the solid feel of this special competition model. The overall weight of the rifle totals 13.5 pounds.

Any of the accurizing parts built into the Bushmaster DCM Rifle can be ordered as accessory additions for your rifle. For more information, call or go online to: www.bushmaster.com or consult us by email: Sales@bushmaster.com

FOR COMPETITION



Bushmaster Target Model Rifles...

20" Bbl. A3 Target Model



Removable Carry Handle is included with A3 configuration Rifles

Caliber 5.56 mm / .223 Rem.

Birdcage Flash Suppressors
Others Optionally Available

Length overall - 39.5 inches

A2 Weight w/o Mag. - 8.43 lbs.

24" Bbl. A3 Target Model



Chrome Lined Bore & Chamber

Rifled 1 x 9" R.H.

A2 Trapdoor Buttstocks

20" Stainless Bbl. A2 Target



Brush Finished 416 Stainless Steel Barrels

The Target Models are the "standards" of the Bushmaster line.

- A3 Rifle Carry Handle Rear Sight has 1/2 M. o. A. for both elevation and windage
- Shipped with 30 Rd. Magazine, Safety Block, Operating / Safety Instruction Manual, and Web Sling in Bushmaster hard case. These Rifles are also available in kit form.
- Heavy match grade barrels of either Chrome Lined Chrome Moly Steel or Polished 416 Stainless Steel
- A2 Models features fixed carry handle w. std. rear sight
- A3 Models have "flat-top" Upper Receiver with Picatinny Rail for scope, sight, or optics attachment



Bushmaster V Match Rifle & Carbine... B.M.A.S. Front Flip Sight fits V Match models (#YHM-9360K) \$106.95

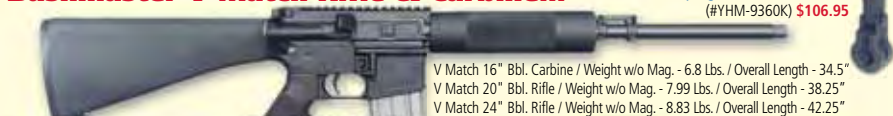

V Match 16" Bbl. Carbine / Weight w/o Mag. - 6.8 Lbs. / Overall Length - 34.5"

V Match 20" Bbl. Rifle / Weight w/o Mag. - 7.99 Lbs. / Overall Length - 38.25"

V Match 24" Bbl. Rifle / Weight w/o Mag. - 8.83 Lbs. / Overall Length - 42.25"

A3 Removable Carry Handle (shown left) is optional for V Match models - clamps onto Upper Receiver - includes 1/2 M.o.A. Rear Sight. (#9349063-9) \$116.95

The V Match "Flat-top" Upper Receiver and "Free-Floater" handguard make these models a great choice for the competitive shooter. Heavy profile, Chromoly vanadium steel, chrome lined barrels consistently deliver match winning accuracy. The knurled, tubular aluminum V Match Handguard lets the barrel "free float" from barrel nut forward for optimum accuracy.

- Bushmaster V Match 16" Bbl. Carbine (PCWVMS 16) Available from your FFL Dealer **M.S.R.P. \$1105.00**
- Bushmaster V Match 20" Bbl. Rifle (PCWVMS 20AH) Available from your FFL Dealer **M.S.R.P. \$1115.00**
- Bushmaster V Match 24" Bbl. Rifle (PCWVMS 24AH) Available from your FFL Dealer **M.S.R.P. \$1125.00**

FOR PLINKING



New for 2007 BUSHMASTER O.R.C.®

[Optics Ready Carbine]

(BCWVMF 16M4ORC)

M.S.R.P. \$1085.00

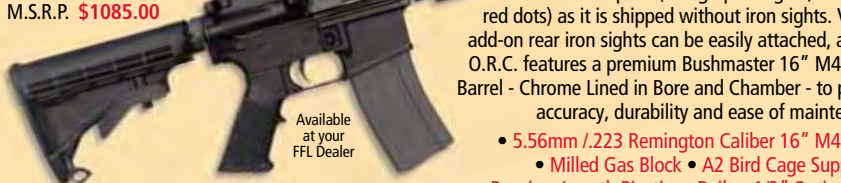

Available
at your
FFL Dealer

Operation: Gas Operated/Semi-Auto
Overall Length: 36.25"
Barrel Length: 16"
Weight w/o Mag.: 6 lbs.

Bushmaster's newest Carbine was developed for those intending to add optics (holographic sights, scopes, or red dots) as it is shipped without iron sights. Various add-on rear iron sights can be easily attached, and the O.R.C. features a premium Bushmaster 16" M4 Profile Barrel - Chrome Lined in Bore and Chamber - to provide accuracy, durability and ease of maintenance.

- 5.56mm / .223 Remington Caliber 16" M4 Barrel
- Milled Gas Block • A2 Bird Cage Suppressor
- Receiver Length Picatinny Rail w. 1/2" Optics Risers
- Oval M4 Type Forend
- Six Position TeleStock
- One Year Bushmaster Warranty
- Shipped in Hard Case with Operator's Safety Manual, 30 Rd. Mag., Safety Block and Sling

Bushmaster Carbon 15 "Top Loader"...

Overall Length - 37"
Length (Stock Retracted) - 33"
Weight - 5.8 lbs.



Bushmaster manufactures the AZC-C15RM4FT Model under License to Patent # 6,739,082

Carbon 15 Top Loading Carbine... (AZC-C15RM4FT)

M.S.R.P. \$1070.00 Available through FFL Dealers

- 16" M4 Profile Chrome Lined Barrel - 1 x 9 twist - with Izzy Suppressor
- A2 Standard Front Sight
- Dual Aperture Rear Sight
- Receiver Length Optics Mounting Rail
- Lightweight Carbon 15 Receivers
- 6 Position Telestock
- Safety Controls Marked on Both Sides of Receiver
- 10 Round Internal Magazine

The unique Carbon 15 "Top Loading" Model has been developed specifically for the California market (and other States with similar restrictions). It offers traditional AR-15 type features, rugged Carbon Fiber composite molded Receivers for light weight and durability, and a 10 Round Internal Magazine - loaded by simply pushing in the Receiver Takedown Pin and then pivoting open the Receivers. This exposes the Internal Magazine components - which are

permanently fixed in position within the Lower Receiver. Cartridges can then be inserted into the Magazine Feed Lips in the same manner as any removable AR-15 type Magazine. Shipped in Bushmaster's lockable hard case with Black Web Sling, Safety Block, Sighting In Target, Operation and Safety Manual - One Year Warranty.

Carbon 15 "Model 4" Carbine...



Caliber- 5.56mm or .223 Rem.
Overall Length - 34.75"
Barrel Length - 14.5" / 16" Overall
Weight - 5.5 lbs.

- 14.5" M4 Chrome Lined Bbl. 1 x 9 twist w. pinned/welded Izzy Compensator
- Receiver Length Picatinny Optics Mounting Rail w. Dual Aperture Rear Sight
- A2 Standard Front Sight
- Lightweight Carbon 15 Receivers
- Safety Controls Marked on Both Sides of Receiver
- 6 Position Telestock - reduces length 4" when collapsed
- 30 Rd. Magazine
- Shipped in foam padded case with Operation Manual, Sling & Warranty Card

Carbon 15 Model 4 Carbine... (AZC-C15M4PRE)

M.S.R.P. \$1155.00 Available through FFL Dealers

Case included... an \$18.95 Value

Bushmaster Carbon 15 Rifle & Pistol Accessories...



A. Threaded Adaptor for Carbon 15 Models... \$26.50 (AZ15133) A Quick Detach Adaptor like the Carbon 15's standard Brake, but designed to accept standard 1/2x28 threaded brakes and suppressors (may require a crush washer).

B. Silent Sling...\$41.95 (AZ723) Standard on the 97S Rifle, this quality tactical sling will fit any other Bushmaster Carbon 15 Rifle. Durable, black ballistic nylon – easy Velcro strap attachment – offers multiple carry modes.

C. / D. / E. Light & Laser Mounts... These Mounts clamp to the barrel fluting on Type 97 Pistols and Type 97 / 97S Rifles to offer a mounting point for the various lights and lasers. The **SureFire Mount – C.** (AZ718) **\$26.95** takes 1" diam. flashlights (they recommend their #650 Universal Weapon Light). The **Mag-Lite Flashlight Mount – D.** (AZ717L) **\$26.95** holds 3/4" diam. lights, and the **Laser Mount – E.** (AZ719) **\$26.95** accepts 3/4" diam. laser sighting units.

F. Carbon 15 Ambidextrous Safety and Safety Lever The complete **Ambidextrous Safety Assembly... \$33.50** (AZ724) is available as a spare or replacement part for your Carbon 15 firearm, or just the Lever can convert existing safeties on Type 21 or 97 Pistols and Rifles to achieve ambidextrous functioning in "weak hand" mode. Machined of aircraft quality aluminum – black anodized. **Safety Lever only... \$11.95** (AZ724L) is molded of Carbon 15.

G. Quick-Pull Takedown Pin for Top Loading Carbine... \$3.95 (AZC-15120) Makes opening the Receivers of the Top Loading Carbine easier and faster - a sling swivel, a split ring or piece of paracord can be attached for a better grasp.

H. Carbon 15 Youth Sized Buttstock... \$26.50 (AZ15279) Perfectly sized for the younger shooter, or smaller woman, this Carbon 15 molded buttstock easily replaces the standard stock on Bushmaster Carbon 15 rifles by releasing the receiver locking lever (will not fit C15 Pistol receivers). It's 8 1/4" overall length yields an 11 1/4" trigger pull length.

I. Recoil Pad for Carbon 15 Buttstock... \$16.95 (2698827) This molded black rubber recoil pad offers extra shooting comfort. Its a slip-on fit on all older Carbon 15 buttstocks, and will fit the new style buttstock with minor modification.

J. Accessory Rail for Carbon 15 R21/R97/R97S & Lady Rifles... \$57.95 (AZ15694) An anodized aircraft aluminum Rail that offers a mounting point for accessories under the forend. Note: Requires drilling/tapping for installation.

K. Accessory Rail for P21S Pistol Forends... \$52.95 (AZ15695) An anodized aircraft aluminum Rail Segment that attaches by drilling/tapping into the Pistol's forend to provide a mounting point for flashlight or laser accessories.

L. Picatinny Optics Mounting Base for P21/P97 Pistols... \$52.95 (AZ716) A machined, anodized aircraft aluminum Rail that slides onto the Pistol Upper and locks in place with a screw. A solid base for standard optics - remains true to zero when removed/reinstalled - see-thru design allows use of Pistol's existing iron sights.

M. Full Length Optics Rail with Integral Sights... \$147.95 (AZ15198) This Picatinny configuration rail (standard on Type 97S Rifle) can be added to Type 97 or Type 21 Rifles as a factory installation (drilling / tapping required) to offer both integral iron sights and unlimited optics mounting. Aircraft aluminum - matte black anodized, the rear sight is a dual aperture flip-up with windage adjustment, and the front sight is an AR standard post - elevation adjustable.

BUSHMASTER XM15-E2S Complete Lower Receiver Assemblies...

Why Bushmaster Lower Receivers are the Best...

- Precision machined from high tensile strength 7075 T6 Aluminum Alloy Forgings – Bushmaster **DOES NOT** use castings.
- Bushmaster Receivers are guaranteed for fit and function to ensure that if you ever buy a second Upper Receiver/Barrel assembly, it will be completely compatible and interchangeable with your lower receiver.
- M16 A2 design reinforcement area around front pivot pin and reinforcing ridge over the receiver extension attachment area for extra strength.
- Protective finish: Hard Anodize Military A8625, Type III, Class 2 finish (lusterless, flat, approximate Black No. 36118 Table IX). We do not paint our receivers.
- Surfaces are bead blasted to a non-reflective matte finish prior to anodizing.
- A Nickel Acetate final seal coating protects against corrosion.
- Raised "ridge" around magazine catch button protects against accidental magazine release.
- Standard pivot pin design connects uppers and lowers with captivated front pivot pin and rear take down pin (so the pins can't fall out and become lost).



Lower Receiver Assembly with Pistol Grip
(ALLOW W/OSTK) M.S.R.P. \$275.00
Also avail. for 6.8mm SPC Caliber
(A LOW W/OSTK-68) M.S.R.P. \$275.00

An FFL is required for the purchase of any Lower Receiver. Contact your local FFL Dealer, prices may vary from suggested retail above.

Lower Receiver Assembly with Six Position "TeleStock", Pistol Grip, and all internal components.

With the Sunset of the 1994 Assault Weapons Ban, Bushmaster can again offer this Lower Receiver Assembly featuring a Six Position Telescoping Stock. This assembly is all Bushmaster highest quality components – complete and ready to use – just snap on your Upper Receiver. An FFL is required for purchase, or you can order through your FFL Dealer. **NOTE:** Assemblies with Telestocks may still be illegal in some States. Check your own State and County Statutes to determine legality.

Also available - Lower Assembly with ATF approved Fixed Length Tele-Style Stock (not shown - see Pistol Grips / Buttstocks Section). **Lower w. Fixed Tele...** M.S.R.P. \$360.00 (A LOW PERMX)



FFL Required for Purchase

Lower with Telestock...
M.S.R.P. \$360.00
(A LOW TELEP)
For 6.8mm SPC...
(A LOW TELEP-68) \$360.00

Lower Receiver Assemblies with Trapdoor, or Skeleton Stock...

Fully assembled and ready for an Upper Receiver - Solid A2 Buttstock (5/8" longer than the original A1) includes "trapdoor" storage compartment.

5.56mm/.223 Cal. M.S.R.P. \$335.00
(A LOW STD)

Also avail. for 6.8mm SPC Caliber
(A LOW STD-68) M.S.R.P. \$335.00

The same Complete Lower Receiver Assembly is also available with the light Ace Skeleton Stock, which offers a comfortable rubber buttpad, a neoprene foam sleeve over the extension tube, and multiple mounting points for the Q.D. sling swivel (included).

Lower w. Ace... M.S.R.P. \$415.00 (A LOW SKELETON)



An FFL is required for purchase of any Lower Receiver. Contact your local FFL Dealer, prices may vary from Suggested Retail Prices shown.

Bushmaster "Stripped" Lower Receiver... This is the premium quality base for those who want to build a Bushmaster Rifle "from the ground up". To assemble this machined 7075 T6 Aluminum Forging, you'll need a Complete Lower Parts Kit and your choice of stocks (see Pistol Grips / Buttstocks Section in this catalog). For complete rifle buildup instructions, we recommend the Bushmaster Video or the U.S. Gov't M16A2 Technical Manual (see Gunsmithing Section in this catalog).

Stripped Lower for 5.56mm... M.S.R.P. \$195.00 (9349102-S)
Stripped Lower for 6.8mm... M.S.R.P. \$195.00 (9349102-S-68)

Bushmaster Carbon 15 "Stripped" Lower Receiver... These are the same lightweight receivers we use on our new C15 M4 Type "Flat-top" Carbine and others. Standard "AR" Parts (like our Lower Receiver Parts Kit) drop right in. Carbon 15 composite components are lighter, cooler in operation and have no surface finish to wear off.

C15 M4 Type Receiver... M.S.R.P. \$195.00 (AZ15780)

Also available:

C15 R21/97/97S Receiver... M.S.R.P. \$195.00 (AZ15180)

C15 P21/97 Pistol Receiver... M.S.R.P. \$195.00 (AZ15179)

For other Carbon 15 Receiver Assemblies, consult your Bushmaster Salesperson. A Federal Firearms License is required for purchase of all lowers.



NOTE: BATF RULING PROHIBITS USE OF M16 COMPONENTS IN LOWER RECEIVER.

See Page 19 for an M16/AR15 parts comparison if you have any doubt about parts in your rifle.

Bushmaster Receivers & Parts 15 Orders 24 Hrs.: 1 800 998 7928

BUSHMASTER Upper Receivers...



Complete A2 Upper Receiver... \$186.95 (Part# AZUR)
Assembled with the A2 Dual Aperture Rear Sight, Ejection Port Cover, and Forward Assist Assemblies. Forged of 7075T6 Aircraft Aluminum, these quality Receivers are machined to mil. spec. or better, and hard anodize finished to a dark gray non-reflective finish. They include an integral brass deflector, and a baked on dry film lube coating inside for long wear and smooth carrier operation. Charging Handle is not included.

Bushmaster A2 Stripped Upper Receiver... \$121.95 (9349063) This ready-to-assemble, fully machined, anodize finished and dry lubed forging is top Bushmaster quality. Start building your AR rifle with the best new stripped Upper Receiver available. Requires a Rear Sight; Forward Assist Assembly and Ejection Port Cover Assembly for completion - all parts and tools to help assemble your Bushmaster Upper are available in this catalog. Also see our Parts Schematic on Pages 40/41.



Bushmaster A1 Upper Receivers... The early AR15/M16 Upper Receiver differed from the current A2 in that its simpler rear sight did not include an elevation adjustment. The Forward Assist Assembly often utilized the "tear-drop" type button although mechanically identical in function to the round type (either are available). Aircraft quality 7075T6 aluminum forgings are used for strength, and they include the integral cartridge case deflector. The finish is a mil. spec., non-reflective hard anodize with a baked on dry film lube coating inside to ensure long wear and smooth carrier operation.

Complete A1 Upper Receiver Assembly... \$154.95 (A1UR) Shown above right - includes Forward Assist Assembly, Ejector Cover Assembly and A1 Sight Assembly.

Stripped A1 Upper Receiver Assembly... \$121.95 (8448524) Shown at right, this is a fully machined and finished forging ready for assembly - does not include Forward Assist Assembly, Ejector Cover Assembly or A1 Sight Assembly.



V Match ("Flat-top") Upper Receiver Assembly - with integral Picatinny rail... \$182.95 (Part# VUR) This is the popular A3 "flat-top" Upper Receiver. It's Picatinny configuration rail allows mounting the wide variety of scopes, sights and optics available for the AR system. It has been carefully machined from a 7075T6 Aircraft Aluminum Forging and is complete as shown with Ejection Port Cover and Forward Assist.

Stripped V Match ("Flat-top") Upper Receiver... \$151.95 (Part# 8448524-V) A fully machined and hard anodize finished 7075T6 Aircraft Aluminum Forging ready for assembly. parts - requires the Ejection Port Cover Assembly and the Forward Assist Assembly shown on next pages.



Carbon 15 Molded Upper Receivers... Injection molded of Carbon Fiber composite developed in the Aerospace Industry, with these light weight and extremely durable Receivers you can build the lightest AR type rifle around. They do not require Ejection Port Covers or Forward Assist Assemblies.

Carbon 15 Flat-top Upper Receiver... \$151.95 (AZ15747) Shown upper right - includes a Picatinny Rail for optics attachment.

Carbon 15 Pistol Upper Receiver... \$139.95 (AZ15067) Pistol Upper (right) is slotted for the Ghost Ring Sight as on P21/97. Call for information and pricing on other Carbon 15 Receivers.



BUSHMASTER Lower Receiver Parts & Kits...

Complete Lower Receiver Parts Kit... Everything necessary to completely build up your Lower Receiver. Kits available with either AR15 or M16* components. (Lower Receiver And Auto Sear are not included).

AR15 Lower Parts Kit ... \$69.50 (Part # ALOW KIT)
M16 Lower Parts Kit*... \$69.50 (Part # MLOW KIT)



*NOTE: M16 parts require FFL or MG Tax Stamp.
M16 Parts are NOT Legal for Sale in California.

DCM Competition Complete Lower Receiver Parts Kit... \$170.95 (ALOWKITCOMP) All parts shown above plus our Adjustable Two Stage Competition Trigger - save \$25 over separately purchased parts.

Bushmaster Competition Trigger - For the Serious High Power Competitor... (8448592-SCGK) \$127.95

A finely honed competition trigger including all the specially modified parts shown - ready for installation in your Lower Receiver. This Trigger can be set for a 3 1/2 lb. DCM legal 1st Stage, and a 1 lb. (2nd Stage) letoff. Also available...

Two Stage Competition Trigger w. Ambidextrous Safety... \$148.95
 (8448592-SCGKA)

NOTE: This Trigger will not fit in Colt Lowers with Block over Safety. Won't work with Large Colt Pivot Pins.



The "Lost" Parts Kit for AR15 Type Rifle... \$13.50 (Part # CP-KIT) The first problem with AR15 maintenance and gunsmithing work is the little spring or detent that pops out and falls into that black hole under the workbench! This Parts Kit - of all the most critical springs, detents, inserts and pins - will get your gun back to full function in short order.

Includes: 4 Takedown Pin Detents; 4 Takedown Pin Detent Springs; 2 Buffer Retainers; 2 Buffer Retainer Springs; 2 Firing Pin Retaining Pins; 2 Safety Detents; 2 Safety Detent Springs; 2 Extractor Spring Inserts; 2 Extractor Springs.



Field Repair Kit... High breakage and loss items in a heavy zip-lock bag. Will fit in Stowaway Grip. Includes extractor, 2 extractor springs, 2 extractor spring insert, disconnecter, gas ring set, extractor pivot pin, firing pin, 2 firing pin retaining pins, cam pin and spring package of 6 springs. **\$31.95 ea.**

For AR-15... \$31.95
 (Part # A FIELD)
or M-16*... \$31.95
 (Part # M FIELD)

*NOTE: M16 Parts are NOT Legal for Sale in California.



XM15/AR15/M16 Emergency Survival Kit... This Kit includes more parts than our Field Repair Kit above - all packed in a handy Olive Drab Carrying Case you can wear on a belt. Carrying Case measures approximately 9.25" x 3.5" (outside dimensions).

Includes Cam Pin, Extractor with 2 Pins and 2 Springs, Extractor Insert, Firing Pin, 2 Firing Pin Retaining Pins, Disconnecter and Spring, Hammer with "J" Pin and Spring, Hammer Pin, Trigger Pin, Trigger Spring, Safety Detent and Spring, Magazine Catch Springs, Gas Rings (3), Sight Adjustment Tool, and 2 Armorer's Punches for Field Disassembly.



Specify with part numbers below: **A1 Type:** (Round Front Sight Post) or **A2 Type:** (Square Front Sight Post) and **AR15 (AR) or M16 (M) parts.** (Note: **M16 parts require an FFL or Form 4 for purchase.**)

Survival Kit w. A1 Sight Tool... \$63.95

(for AR15 - AR EMERG A1 / for M16 - M EMERG A1)

Survival Kit with A2 Sight Tool... \$63.95

(for AR15 - AR EMERG A2 / for M16 - M EMERG A2)

Bushmaster Receiver Spring Package... \$2.95
 (Part # SM SPRING PACK) Tighten your Receiver's action with this top quality Spring Kit.

Includes Springs for Hammer; Trigger; Ejector, Extractor, Magazine Catch and Disconnecter.



Complete AR15/M16 Pin & Detent Package... \$7.50 (# AR PIN PKG) Includes every pin and detent in the gun - a \$13 value if sold separately. Contains: 2 Hammer/Trigger Pins; 2 Front Sight Taper Pins; Firing Pin Retaining Pin; 2 Takedown Pin Detents; Safety Detent; Bolt Catch Plunger; Extractor Pin; Gas Tube Roll Pin; Front Sight Detent; Ejector Pin; Forward Assist Pin; Bolt Catch Pin; Buffer Detent; Trigger Guard Pin.

BUSHMASTER Lower Receiver Parts & Kits...



MagPul Enhanced Aluminum Trigger Guard for AR15/M16 (MAG015) \$19.95

A drop-in oversized trigger guard that replaces the standard plastic or metal type, this hard anodize finished piece offers greater access to the trigger (especially when using gloves), reduces chance of accidental discharge, and fills the blister causing gap between the receiver tabs. Installs with a replacement roll pin and a 1/16" Allen Head set screw. Made in U.S.A. / Instructions included.



Complete AR15 Spare Parts Kit... \$39.50 We've taken our Field Repair Kit, our Complete Spring Package, and our Complete Pin & Detent Package and combined them into one "super-kit" that will take care of all your AR15 rifle's spare parts needs. You'll get all these parts and more: every Spring in the Gun (including Buffer Spring); Firing Pin; 3 Firing Pin Retaining Pins; Cam Pin; Disconnecter; Extractor; Extractor Pivot Pin; 2 Extractor Spring Inserts; Gas Ring Set; 2 Hammer & Trigger Pins; 2 Front Sight Taper Pins; 2 Takedown Pin Detents; Safety Detent; Bolt Catch Plunger; Gas Tube Roll Pin; Front Sight Detent; Ejector Pin; Forward Assist Pin; Bolt Catch Pin; Buffer Detent; Trigger Guard Pin. This is a great value for only \$39.50! (Note: If you have our Fixed Length Tele-Stock, please choose the Rifle Buffer Spring Package. Not all parts are shown, and not shown to correct scale.)

Specify your choice of:

Complete AR15 Spare Parts Kit

Parts Kit w. Rifle Buffer Spring

(Part # ARPARTSKIT)

OR

Complete AR15 Spare Parts Kit

Parts Kit w. CAR Buffer Spring

(Part # ARPARTSKIT-C)

Complete Spring Package... \$10.50 Every spring in the gun, including the Buffer Spring. Please specify if for Telestock Carbine (Part # A COMP SPR PKG-C), or Standard Buffer Spring (Part # A COMP SPR PKG).

AR15/M16 Accu-Wedge... \$6.50 (Part # ACU1B) Accu-Wedge eliminates play between Upper and Lower Receivers for a more solid feel. Buffers the cycling system to reduce wear on the impacting surfaces. Easily installed, no modifications required. Drop the Accu-Wedge into the rear of the

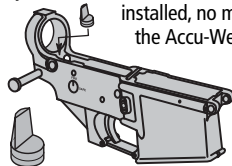

Lower Receiver - close the Upper Receiver, squeeze, and push the Takedown Pin into place.

AR-AR Push Pin... \$10.95 (Part # OAK-01)

Replaces the big two-screw bolt in the front pivot hole on Colt receivers (will only fit Colt Sporters).

Converts receiver to standard takedown operation - as on the military version.



Anti-Walk Pins... for XM15, AR15 and M16...

Set of Two Pins with Circlips... \$6.50 (WE-002)

Designed to prevent trigger or sear pin walkout under rapid fire conditions.

Steel with black phosphated finish.



AR15 or M16* Ambidextrous Safety Selector...

Don't be penalized for being left handed any longer.

Installs easily into your lower receiver and enables activation of the rifle with either hand. Assembles with a button head Allen Screw. For the M16 part, an FFL, or a copy of your Form 4 is required for sale.

AR15 (Part# MMT-0007K) **\$36.95**

M16* (Part# MMT-0006K) **\$36.95**



***M16 Parts are NOT Legal in California)**

Ambidextrous Magazine Release... \$95.95

(8448638-ambi) Now, release magazines from either side of the receiver - especially handy for lefties.

This well made assembly is an easy replacement for your stock magazine release - uses stock button and spring. No receiver modification is required, the design reduces the possibility of accidental release, and helps keep out sand and mud. All steel construction with a mil. spec. manganese phosphate finish. Made in U.S.A.

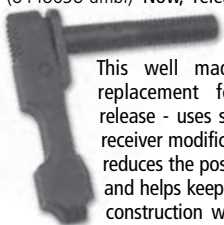

Expandable Tensioning Pin For All AR15 Type Rifles... \$36.95

(Part # ARTP) These pins are designed to cure the looseness between older upper and lower receivers. Install and tighten with an Allen wrench, and this precision pin pulls the upper receiver down onto the lower for a rock hard custom fit. Improves accuracy in even the poorest fitting upper and lower receivers.

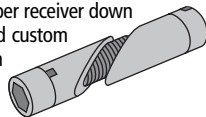

Reverse Offset Pin... \$16.95

(Part # WE-003) Allows mounting a Colt Upper Receiver with large pin holes to a mil. spec. (small hole) push pin type Receiver.

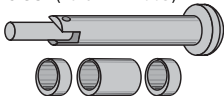

BUSHMASTER Lower Receiver Parts & Kits...

Offset Pin... \$6.50
(NES-06) Adapts a Colt Lower Receiver (with large hole) to M16 Forward Assist type Upper Receiver with smaller hole.



M16*A2 Three Shot Burst Set... \$63.95
(3SHOT BURST KIT) Installation of this set in your M16A1 machine gun will give you a Three Shot Burst capability as in the M16A2. New, highest quality parts. An FFL is required for sale, or a copy of your Form 4. Not legal for installation in anything but a licensed machine gun.

***M16 Parts are NOT Legal for Sale in California.**



M16* Full Auto Sear... \$31.95
(8448595) Includes Pivot Pin, Bushing and Spring.

Note: An FFL or Tax Stamp is required for purchase.



Individual Lower Receiver Parts for Late Model COLT AR15s... These are the hard to find parts for the late model Colts requiring the larger .172" diameter Hammer and Trigger Pins.

Hammer... \$23.50 (Part # 8448612-SCK)

Trigger... \$21.50 (Part # 8448592-SC)

Disconnecter... \$7.50 (Part # 8448635-SC)

Hammer or Trigger Pin... \$3.50 (Part # 8448609 C)

For All 5 Parts in a Kit - Hammer; Trigger; Disconnecter (Semi-auto); Hammer and Trigger Pins... \$53.95 (Part # AR COLT KIT)

AR15 or M16* "Re-hab" Kit... \$35.95 ea.
Hammer, Trigger, Safety Selector and Disconnecter. Specify whether for **Semi-Auto or Full-Auto**.

***NOTE:** M16 Kit must be used in a Title II Receiver for legality. An FFL or Tax Stamp is required.

For Semi-Auto AR15s,
(Part # A REHAB)
\$35.95 or
For Full-Auto M16s,
(Part # M REHAB)
\$35.95

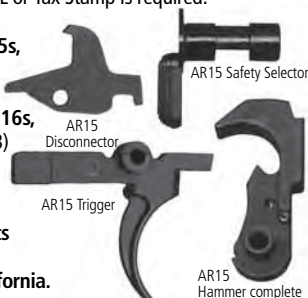

***Note: M16 Parts are NOT Legal for Sale in California.**

A STATEMENT FROM BUSHMASTER REGARDING MACHINEGUN PARTS

The position of the Bureau of Alcohol, Tobacco and Firearms (ATF) is that if your AR15 type rifle contains even one M16 component, it is a Machine Gun. If you own an AR15 from any manufacturer, check to make sure there are no M16 components in it's assemblies. If there are, remove them immediately. Machine them to AR configuration, or replace them and destroy the M16 components. Refer to the illustrations below to determine if you have M16 components in your assemblies. If you have any questions about your parts, give us a call and we'll be glad to supply you with the legally acceptable parts.

Sales of M16 components by Bushmaster Firearms International, LLC will only be made to the following categories of customers: (1) Class 3 (NFA) Dealer. (2) Individual who has a registered NFA weapon. (3) Federal Firearms Licensee with a customer who has a registered NFA weapon.

Note the Differences* Between the Corresponding Parts in Each Drawing

AR15 PARTS

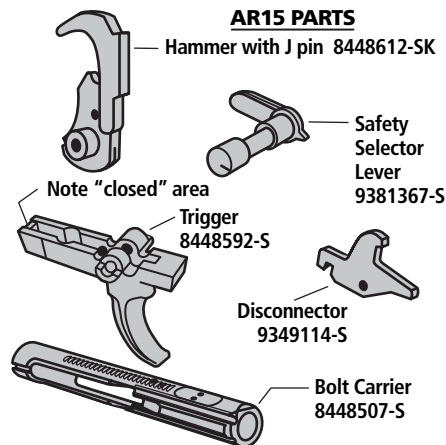

M16 PARTS

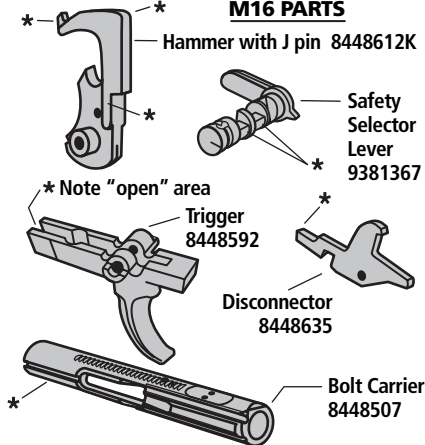

BUSHMASTER Upper Receiver Parts...

A fully assembled, Chrome Lined Bolt Carrier with Key staked on - and all parts illustrated here. Includes Bolt Assembly and Firing Pin. Ready to use in your rifle, or keep as backup.

Bushmaster Complete Bolt & Bolt Carrier

Assembly... \$137.95 each

For AR15... Part # 8448501-S

For M16*... Part # 8448501

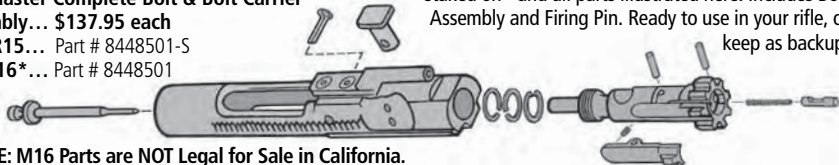

***NOTE: M16 Parts are NOT Legal for Sale in California.**

AR15 or M16 Bolt Carrier Assembly with Key Staked on... \$92.50 each These are new bolt carriers machined of highest quality gun steel - not rewelds or remakes - and they are chrome lined for smooth bolt functioning and long life. The bolt carrier assembly is the "heart" of your rifle - with the most critical machining tolerances of any component in the weapons system. We manufacture to mil. spec. or better, and magnetic particle inspect to insure against cracks or flaws that could cause catastrophic failure or injury.

For AR15... \$92.50 (8448505-S)

For M16*... \$92.50 (8448505)

NOTE: M16 Bolt Carriers must be used in Title II Receivers for legality.

An FFL or Tax Stamp is required for purchase. *NOTE: M16 Parts are NOT Legal for Sale in California.

AR15 or M16 Bolt Carrier without Key... \$78.95 each Same quality Chrome Lined Carrier as shown above, but without the Carrier Key for the "do it yourselfer".

AR15... \$78.95 (8448507-S)

For M16*... \$78.95 (8448507)

CAUTION: Bolt Carrier Keys must be "staked" onto the Carrier for safe and proper functioning in your rifle. See next page to purchase Carrier Key. For information on this procedure, or any AR15 assembly/disassembly work, we recommend the Bushmaster Video or the U.S. Government M16 Technical Manual (see Gunsmithing Section).

***NOTE: M16 Parts are NOT Legal for Sale in California.**

Complete AR15 Bolt Assembly... \$56.00 (8448509) Includes Bolt, Extractor Assembly, Pins, Gas Rings, Ejector Assembly - all highest quality parts completely assembled, and ready for use in your rifle.

AR15 Bolt Assembly
Parts detail illustration...



Forward Assist Assemblies... \$21.50 ea.
"Teardrop" or Round Style...

Quality assemblies are machined from 4140 ordinance steel - heat treated to avoid gouged bolt carrier problems or wear on the pawl tip - Manganese Phosphate finished.



Teardrop Style... (9349086-TD KIT)

Round Style... (9349086 KIT) \$21.50 ea.

Ejection Port Cover Assembly... \$12.95

(A EJ COV ASS) Manganese Phosphate finished in matte grey/black color to match hard anodized uppers. All new parts including Cover with Latch, Rod, Spring and Circlip.



Bolt Carrier Rebuild Kit... Bring your Bolt Carrier Assembly back up to new specifications. Includes all parts shown to rebuild your Bolt and Carrier. \$37.95 each

For AR15... (A BC REBUILD)

M16*... (M BC REBUILD)

***NOTE: M16 Parts are NOT Legal for Sale in California.**
WARNING: Key must be staked onto Carrier

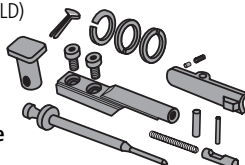

Bolt Cam Pin... \$4.50 (8448502) This quality replacement pin is critical to the safe functioning of your AR type rifle. These are machined of hardened steel to military specs. or better, then Manganese Phosphated for protection against rust or corrosion.

Titanium Firing Pin... \$42.50 (13-7015) Titanium is 40% lighter than steel for faster lock time, and greater accuracy. Precision machined and patented. Increases your safety by reducing the possibility of a "slam fire". This pin fits either AR15 or M16.



Chromed Steel Firing Pin... A standard, mil. spec. Firing Pin for the AR15 or M16. Keep a spare in the buttstock compartment. For AR15... (8448503-S) \$7.50 For M16... (8448503) \$7.50



Bushmaster Upper Receiver Parts...

Standard Charging Handle Assembly... \$26.50 (Part # 8448517) These are not steel stampings that might bend or distort from heat buildup. Precision machined from 7075T6 aircraft quality aluminum forgings, they are hard anodize finished per U. S. mil. spec. - with latch installed.



AR15/M16 Charging Handle Tactical Latch...

\$21.95 (1005-249-02) Sturdy steel construction – improves on the standard charging handle latch and allows easy weapon charging, or left handed operation when using a scope or other optics. Installation is a simple replacement – don't lose your existing latch spring or pin when you change over to this latch on your charging handle.



NEW! From BUSHMASTER... Enidine Hydraulic Buffer / Rate Reducer... A drop-in replacement for standard buffers - with units designed for either rifles or carbines. This rugged "shock absorber" will add reliability to your AR, reduce felt recoil, improve accuracy and protect your optics from excessive shock. For Full Auto guns, they'll bring firing rate down to a very manageable level, and smooth out the functioning of the gun. Bushmaster installs them in our short barreled Full Auto models. Quality alloy steels with a black oxide finish; action rod is nickel plated for smooth operation. Rear "bumper" is molded black polyurethane.

Hydraulic Buffer / Rate Reducer for Carbines... (Part # HB-1A) \$ 89.95 / For Rifles... (Part # HB-2A) \$ 99.95

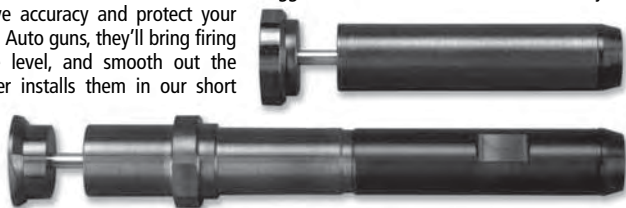

See Pages 40/41 for a Parts Schematic Diagram

INDIVIDUAL PARTS FOR LOWER RECEIVERS...

| | |
|---|----------------|
| Bolt Catch Assembly (A BCAT ASS) | \$6.50 |
| Bolt Catch (8448628) | \$5.50 |
| Bolt Catch Spring (8448633) | .55 |
| Bolt Catch Plunger (8448634) | .55 |
| Bolt Catch Pin (MS16562-119) | .55 |
| Buffer Detent (8448582) | \$1.60 |
| Buffer Detent Spring (8448583) | .55 |
| AR15 Disconnecter (9349114-S) | \$5.95 |
| M16 Disconnecter* (8448635) | \$5.95 |
| Disconnecter Spring (8448594) | .55 |
| AR15 Hammer w. J pin (8448612-SK) | \$14.95 |
| M16 Hammer w. J pin* (8448612-K) | \$14.95 |
| Hammer Pin (8448609), Trigger Pin (8448609), or Sear Pin (8448599) each... | \$1.00 |
| Hammer Spring (8448611) | \$1.00 |
| Magazine Catch Assembly (A MC ASS) | \$4.95 |
| Magazine Catch (8448638) | \$3.50 |
| Magazine Catch Button (8448636) | \$1.50 |

| | |
|--|----------------|
| Magazine Catch Spring (8448637) | .55 |
| Pistol Grip A2 (9349127) | \$12.95 |
| Pistol Grip Screw (ANS01D416-18) | .65 |
| Pistol Grip Screw Washer (MS35335-61) | .45 |
| Pivot Pin (Front) (8448621) | \$4.20 |
| Pivot Pin Detent (8448585) | .55 |
| Pivot Pin Spring (8448586) | .55 |
| AR15 Safety Selector (9381367-S) | \$10.95 |
| M16 Safety Selector* (9381367) | \$10.95 |
| Safety Detent (8448631) | \$1.00 |
| Safety Detent Spring (8448516) | .85 |
| Take Down Pin (Rear) (8448584) | \$4.20 |
| Take Down Pin Detent (8448585) | .55 |
| Take Down Pin Spring (8448586) | .55 |
| Trigger for M16* (8448592) | \$11.95 |
| Trigger for AR15 (8448592-S) | \$11.95 |
| Trigger w. Spring for AR15 (9349115-S) ... | \$12.95 |
| Trigger Spring (8448593) | \$1.00 |
| Trigger Guard Assembly (8448587) | \$5.50 |

***NOTE: M16 Parts are NOT Legal for Sale in California.**

INDIVIDUAL PARTS FOR UPPER RECEIVERS...

| | |
|--|----------------|
| Bolt Cam Pin (8448502) | \$4.50 |
| Bolt Carrier Key with screws/must be staked (AR BC KEY/SCREW) | \$15.95 |
| Bolt Gas Rings (set of 3) (8448511K) | \$3.15 |
| Ejector Assembly (A EJECT ASS) | \$3.50 |
| Extractor Assembly (A EXTRAC ASS) | \$14.95 |
| Extractor (8448512) | \$13.95 |
| Extractor Pin (8448513) | \$1.00 |
| Extractor Spring (8448755SP) | \$1.50 |
| Extractor Spring Insert (8448754) | .80 |
| Firing Pin (8448503 or 8448503-S) | \$7.50 |

| | |
|--|----------------------------------|
| Firing Pin Retaining Pin (8448504) | \$1.00 |
| Buffer - Standard (8448615) | \$15.95 |
| Buffer Spring - Standard (8448629) | \$5.95 |
| Receiver Extension - Std. A2 (8448581) ... | \$21.95 |
| Buffer - Telestock (1005-914-4578) | \$16.95 |
| Buffer - Telestock - heavy weight for M16M4 machine gun (8448730-M) | \$26.50 |
| Buffer Spring - Telestock (1005-914-4564) ... | \$5.50 |
| CAR Receiver Extension - for the newer style 6 Position Telestocks | (1005-914-2929-6) \$26.50 |
| CAR Receiver Extension - for older style 4 Position Telestocks | (1005-914-2929-P) \$26.50 |

PARTS FOR BUSHMASTER COMPETITION RIFLES... (can be fitted to standard models as well)

DCM Competition Lower Receiver Assemblies... All Include our factory set DCM Two-Stage Competition Trigger.

• Complete DCM Competition Lower

Assembly... Lower Receiver with A2 Buttstock, Competition Buttstock Weight, Pistol Grip and Two Stage Trigger as shown. (Part# A LOW STD W/CGWT) M.S.R.P. ... **\$430.00**

• **DCM Lower Assembly...** Same assembly as above less Buttstock Weight. (Part# A LOW STD W/CG) M.S.R.P. ... **\$410.00**

• **DCM Lower Receiver Assembly minus Buttstock...** Includes Pistol Grip, DCM Two Stage Trigger and all internal parts - as shown at right. (Part# ALOW W/OSTK W/CG) M.S.R.P. ... **\$360.00**



Lower Receivers available only through FFL dealers.

DCM Competition A2 Upper Receiver Assembly with A2 Competition Rear Sight... Includes Forward Assist, Ejection Port Cover and One Competition Sight Micro-Aperture in your choice of four "peep" sizes - please specify size (see descriptions below).

• **DCM Upper Receiver with 1/2 Minute Rear Sight...** **\$223.95** (Part # A2URCG2)

• **DCM Upper Receiver with 1/4 Minute Rear Sight...** **\$223.95** (Part # A2URCG4)



Bushmaster DCM Competition Heavy Barrel with Factory Matched Bolt and Front Sight Base... **\$313.95** (9349054-20CGA) A lapped 20" Barrel, button rifled in 1 x 8, features an 11° competition muzzle crown, and a custom match hybrid chambering with longer throat, or "Leade" to accommodate 5.56mm ammunition. This avoids the higher pressures developed when shooting 5.56mm ammo in a .223 caliber chamber that has a shorter "Leade" (both calibers can be safely used). Finest Chrome Moly Vanadium Steel with a Manganese Phosphate finish - full 1" diam. from the barrel extension forward to the sight base step. **Note: Requires Gunsmithing assembly to achieve optimum accuracy.**

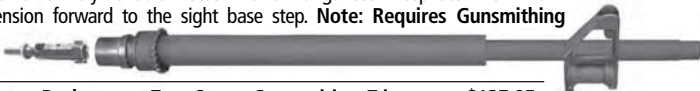

Bushmaster Two Stage Competition Trigger... **\$127.95**

(8448592-SCGK) This finely honed competition trigger includes all the specially modified parts shown plus instructions - ready for installation in your lower receiver. This trigger can be set for a 3 1/2 lb. DCM legal 1st Stage and a 1 lb. (2nd Stage) letoff. **NOTE: This Trigger will not fit in Colt Lowers with a "Block" over the Safety, and is not designed to work with large Colt pivot pins.**

Also Available... Two Stage Competition Trigger with an Ambidextrous Safety... **\$148.95** (8448592-SCGKA)



Bushmaster Competition A2 Rear Sight Assembly... Highly accurate Rear Sight Assemblies with the new "Stay-Straight" dual detent mechanism for the serious competition shooter. Elevation and windage mechanisms are available in either 1/2 or 1/4 Minute of Adjustment. The flip-up is machined to allow installation of different interchangeable Micro-Apertures (one aperture included with each complete sight or flip-up assembly). These precision machined inserts are available in 4 aperture sizes: .036" / .040" Standard (9 out of 10 shooters find the .040" standard aperture works best, your eyes may differ) / .046" or .052"

• 1/2 M.o.A. Rear Sight with choice of aperture size... **\$122.50** (9349072CGA2)

• 1/4 M.o.A. Rear Sight with choice of aperture size... **\$122.50** (9349072CGA4)



Bushmaster DCM 1/4 Minute Windage Competition Rear Sight Conversion Kit... **\$21.50** (AR 1/4MIN CONVK) Convert your old A2 sight to 1/4 Minute of Adjustment window configuration with these high quality competition parts. Kit includes 1/4 M.o.A. Drum, Pin, Detent Springs and Balls.

"The Hood"... (9349075CGH) **\$15.95** A Competition Rear Sight Shroud, (shown center in photo) this tubular, threaded insert for our competition flip-up eliminates all glare and improves your sight picture. Internally threaded to accept the micro-aperture of your choice.

"The HOOD KIT"... **\$40.50** Includes our Competition Flip-up; the Hood Sight Shroud and your choice of one Competition Aperture (sizes at right). Part numbers below indicate the size of the aperture opening. **Choose from...** Part #: CGF36HK / CGF40HK / CGF46HK / CGF52HK



Extra Competition Sight Apertures*... **\$10.95 ea.**

Choose from: **.036"** (CGI36) / **.040" Std.** (CGI40) / **.046"** (CGI46) / **.052"** (CGI52). These thread directly into the flip-up in your Competition Sight. Your vision determines which Micro-Aperture suits you best (most shooters prefer the .040" standard).

Any Three Apertures can be purchased as a set... **\$25.95*
Select from sizes listed above.

NEW... Shorter Competition Hood... This variation on the Competition Rear Sight Shroud above was created to allow shooters who wear glasses to get as close as possible to the rear sight without scratching their glasses.



Short Competition Hood... **\$15.95**
(9349075CGH-S)

PARTS FOR BUSHMASTER COMPETITION RIFLES...

A2 Competition Front Sight Post... \$13.95

A quality sight post that is surface ground on three sides for optimum visual clarity - replaces your existing sight post. Available in 2 widths - Specify...**.052"** (9349056CG52) / **.062"** (9349056CG62)



A2 Competition "Flip" Sight... \$26.50

Shipped with One Micro-Aperture. Choose from these 4 Aperture sizes: **.036"**(CGF36) / **.040"**(std.) (CGF40) **.046"**(CGF46) / **.052"**(CGF52)



Bushmaster DCM "Free-Floater" Kit - A Barrel Nut / Free-Floater Tube / Handguard Combination... \$159.95

(9349059CGA) Designed to meet all DCM regulations, this competition forend allows the Barrel to free float from the Barrel Nut forward for maximum accuracy. A Sling Swivel Loop is mounted to the bottom-front of the tube, and Handguards, Delta Ring, Weld Spring, Snap Ring and a Special Gas Tube are all included in this kit.



DCM Free-Floater Tube & Custom Gas Tube Set... \$132.95 (Part # 2698823)

Standard handguards will require minor modifications to fit.



Competition Handguard Balance Weight...\$31.95

(GPSS-HBV) This lead balancing weight fits inside the bottom half of the standard A2 handguard to add forend weight to your competition rifle (a companion to the buttstock weight above). Weighs approx. 3.5 lbs., it can be cut down for perfect balance. (Handguard half is shown for reference only - not included.)



A2 Buttstock Balance Weight... \$21.50

(Part # 9349119SW) Fits snugly in the standard A2 buttstock compartment without rattle - a 3.62 lb. chunk of lead that can be trimmed to help achieve a perfectly balanced rifle. Its wedge shape and rubber pressure pad ensure a tight, rattle-free fit.

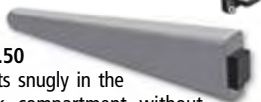

Single-Shot Magazine Follower... \$13.95 (SS-FOL)

A blue plastic follower that installs easily inside most "AR" type .223/5.56mm magazines - allows single shot loading of extra long competition handloads that won't function in regular magazines. Shown separately and installed. Magazine not included.



AR15/M16 Lower Receiver Safety Block... \$7.50 (SB16)

This bright yellow safety block locks into the magazine well when the bolt is retracted and indicates a safe weapon. We use them regularly here at the Bushmaster factory!



Lower Receiver Safety Block with Flag... \$8.50 (SB16F)

Similar to the safety block above, this improved model adds a safety flag that shows out of the open ejection port - a competition and range safety must!



Chamber Checker Safety Flag \$2.50

(CC Chamber Check)

This tough yellow plastic flag slips into the chamber. Close the bolt on it, and it clearly shows your rifle's range-safe status (shown separately, and installed above).

Turner Saddlery AWS Competition Sling... \$74.50 (TS-NMSRS)

A high quality sling approved for DCM High Power Competition for use by CMP and NRA with the AR15/M16 rifle, it is made of a new all weather synthetic (AWS) material that requires no "break-in" and will not stretch. Custom stamped with the Bushmaster logo.



Black - 54-56" long

NEW... Bushmaster Competition Sight Service Tool... \$10.95

(CG-MPT) A combination Front Sight Adjustment Tool and Rear Shroud Insert "Screwdriver" machined of steel with black finish, and knurled for a non-slip grip. Length - 2"



AR15 Bolt Release Extension...\$47.95 (SSP-1)

A finely machined aluminum lever to help High Power Competitors get back on target faster by keeping the forearm hand in place. After inserting a fresh mag, simply push the lever with the trigger finger to snap the bolt forward - no more reaching over the rifle. It slips over the bolt catch release, and locks in place with supplied set screw and Allen wrench.



PARTS FOR BUSHMASTER COMPETITION RIFLES...

Safety Block for AR15/M16 Rifles and others... \$2.50 (SBBF1) Orange plastic with Bushmaster name molded in. The cone end is inserted into firing chamber - the "handle" end protrudes to show safe condition of rifle. Bushmaster includes this Safety Block with every complete rifle sold.



Moly-Slide™ Lubricating Paste... \$8.50 (MS-100) Works great on competition triggers! A 60% Molybdenum Disulfide (MoS2) lubricating paste for wear resistance, anti-seizing and anti-galling on cams, bushings, and other sliding surfaces. Moly-Slide™ has a very wide working temperature range with minimal evaporative loss. The 1 oz. jar will usually last the average shooter/gunsmith for years - a little Moly-Slide™ goes a long way!

Sinclair International Sight and Muzzle Cover Set... \$14.95

(14-200) Often seen on the DCM ready line, these popular protective covers are molded from durable bright yellow vinyl to protect "sight zero"; to keep dirt out of the muzzle, and to offer high visibility. The set includes Front and Rear Sight Covers and two sizes of Muzzle Guard Covers - one for rifles with flash suppressors and another for rifles with plain competition crowned muzzles.



4 Piece Set

UVEX Sharp-Shooter Safety Eyewear - Includes Free Earplugs... These tough, sporty, and lightweight Uvex Shooting Glasses protect both your eyes and your ears! - they come with free earplugs. Polycarbonate uni-lens blocks 99.9% of harmful ultraviolet radiation from the sun, and is "Ultradura" hardcoated to guard against abrasion and scratching. They're tough enough to meet ANSI Z87.1-1989 and OSHA guidelines, and their wrap-around design provides excellent peripheral vision. Black poly-carbonate frames feature adjustments for temple length and tilt for a custom fit. Each pair of Uvex glasses includes Shooters Earplugs warranted to reduce noise by 30



decibels (ANSI test S3.19-1974). Three different lens colors available: clear; amber, and espresso. Great eye and ear protection at a great price!

UVEX Sharp-Shooter Safety Eyewear with Free Earplugs included...

Espresso Lens... \$12.95 (R-03513)
Amber Lens... \$12.95 (R-03512)
Clear Lens... \$12.95 (R-03511)



Peltor President Hearing Protector... \$24.95 (AOS97069) Peltor's President model features exclusive liquid foam ear cushions that are designed for all-day comfort and the padded stainless steel wire headband and generously sized earcups automatically self-align for perfect fit and protection. The President offers a noise reduction rating of 24 decibels, and its earcups can be adjusted in height from the headband. The headband will fold down around the earcups for compact storage.

Bushmaster Competition Parts

Orders - 1 800 998 7928

Bushmaster Upper Receiver / Barrel Assemblies...

Swap them out as needed on your lower receiver to appreciate the versatility designed into the **Bushmaster system!** Bushmaster Upper Receiver/Barrel Assemblies offer the benefit of the years of AR15/M16 design, materials and finish improvements. Either our Chrome-Moly Vanadium Steel Barrels with hard chrome lining in both bore and chamber, or our Stainless Steel Barrels, are the finest available. The latest M16A2 sight systems; integral brass deflectors and hard anodize finish are incorporated into the receivers. These assemblies are all factory headspaced, test fired, and shipped completely ready to use. They include charging handle, bolt and bolt carrier assemblies, handguards and forends. They can also be purchased without charging handle, bolt and bolt carrier assemblies if you already have those parts in another rifle. Just swap them over - that's the beauty of the Bushmaster weapons system.

CAUTION! With the "Sunset" of the 1994 Assault Weapons Ban on Sept. 13th, 2004, Bushmaster can again offer features on the AR15 type rifle that had been deemed illegal for those 10 years - such as flash suppressors, bayonet lugs and high capacity magazines. Though the Federal legislation has expired, certain States have retained their own versions of "Assault Weapons Ban" Statutes, and prospective buyers should check their own State and County laws to determine the local legality of rifles with these features and accessories.

OPTIONS TO CONSIDER...

when ordering Bushmaster Upper Receiver/Barrel Assemblies...

We manufacture hundreds of different combinations - add the options below to the price of the assembly you choose. If you have any questions about the function, compatibility or legality of the various configurations, please consult with your Bushmaster Salesperson.

For Fluting - available on most Bushmaster barrels (Some exceptions. Add F as suffix to Part #) **Add \$50.00**

For Assemblies with V Match "flat-top" Upper Receiver (Substitute A3 for A2 in part #) **No Addtl. Charge**

Note: Our A3 Removable Carry Handle is optionally available with V Match "flat-top" Uppers (9349063-9) **Add \$100.00**

For Assemblies with V Match Round Aluminum Free-floater Forend (SGW-01/02) **Add \$45.00**

For Assemblies with Varminter Vented Aluminum Free-floater Forend (VAR-01K) **Add \$75.00**

See our Muzzle Brakes / Flash Suppressors Section (Pgs. 46-48) for details on the wide variety available...



Izzy Compensator

A2 Birdcage

Y Comp

Mini Y Comp

AK Brake

Phantom

NEW ... 5.56mm/.223 Caliber Gas Piston Upper / Bbl. Assembly

Bushmaster incorporates an ultra reliable Gas Piston Operating System into this new Upper Receiver/Barrel Assembly. Like systems found on AK-47s and FALs, this functions with a wider range of ammunition - using less gas pressure - and reduces maintenance to a minimum.

Includes BMAS Front Flip Sight
(Part# YHM-9627)

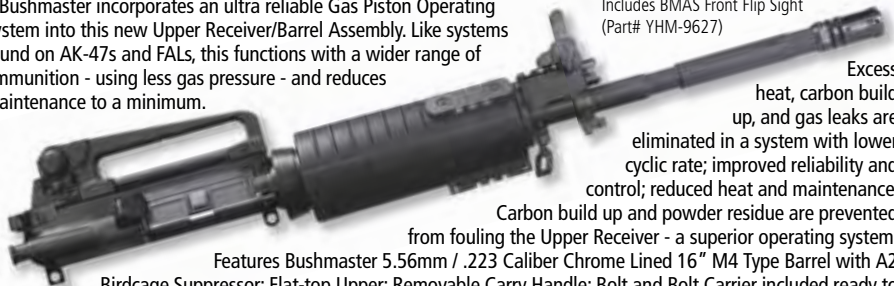

Excess heat, carbon build up, and gas leaks are eliminated in a system with lower cyclic rate; improved reliability and control; reduced heat and maintenance.

Carbon build up and powder residue are prevented from fouling the Upper Receiver - a superior operating system.

Features Bushmaster 5.56mm / .223 Caliber Chrome Lined 16" M4 Type Barrel with A2 Birdcage Suppressor; Flat-top Upper; Removable Carry Handle; Bolt and Bolt Carrier included ready to mount on any standard pin dimension Lower Receiver. Carries Bushmaster One Year Warranty - Weight 4 lbs.

Bushmaster 5.56mm / .223 Rem. Caliber Complete Gas Piston Upper Receiver / Barrel Assemblies...

A3 Type w. Removable Carry Handle... (BURA3B 16M4-GP) **\$1095.00 / A2 Type...** (BURA2B 16M4-GP) **\$995.00**

NEW... Bushmaster 6.8mm SPC Upper Receiver / Barrel Assembly...

6.8mm SPC Caliber • 16" M4 Profile Barrel • 6 Position Tele-Stock • with 26 Round 6.8mm Magazine

Mount a "Bushmaster of a higher caliber" on your existing Lower! The .270 cal. 6.8mm SPC (Special Purpose Cartridge) was developed for the military, but is now available commercially. Velocity averages a bit over 2600 FPS (with Hornady 115 Gr. V-Max), and the heavier bullet weights deliver a terminal energy capable of bringing down larger game. Complete 6.8mm SPC Barreled Upper Receiver Assemblies include one 26 Round Magazine.



Bushmaster 6.8mm SPC Caliber Upper Receiver/Barrel Assembly...

A3 Type (BURA3B 16M468) **\$760.00**

A2 Type (BURA2B 16M468) **\$660.00**

6.8 SPC Uppers are available in A2 or A3 configuration.

(A3 - shown here - includes Removable Carry Handle).

Bushmaster Carbon 15 5.56mm/.223 Rem. Upper Receiver/Barrel Assemblies...

Carbon 15 "Flat-top" Upper Receiver/Barrel Assembly... Features an aluminum Picatinny Rail on a Carbon 15 Composite Upper; 5.56mm/.223 Rem. Caliber 16" M4 profile Chrome Lined Barrel with Izzy Compensator; Standard A2 Front Sight with square post (elevation adjustable); and carbine length handguards. This assembly is complete with Bolt, Carrier and Charging Handle.

Carbon 15 "Flat-top" Upper Receiver Barrel Assembly... (AZ15676) **\$605.00**

Same Assembly Less Bolt, Carrier & Charging Handle... (AZ15722) **\$455.00**



Also, Carbon 15 "Model 4" Upper Receiver/Bbl. Assembly... (AZ15748) **\$625.00** Similar to the Flat-top above but with 14.5" M4 Barrel / Izzy Compensator permanently affixed. Upper includes Raised Picatinny Rail and Integral Dual Aperture Rear Sight. **Assembly Less Bolt, Carrier & Charging Handle...** (AZ15746) **\$475.00**

Bushmaster Upper Receiver/Barrel Assemblies...

NEW... Bushmaster Predator 20" Upper Receiver/Barrel Assembly...



Bushmaster Predator 20" Fluted Upper Receiver/Barrel Assembly... \$750.00 (PURVMB 20FPRED8)

Adapted from our very accurate and successful 24" Varminter, the Predator Upper Receiver/Barrel Assembly's 20" Fluted Extra Heavy Barrel is button rifled 1 x 8" to stabilize the heavier 69-77 grain bullets that a predator hunter/caller would choose for bigger varmints and predators. This superb barrel features fluting for increased cooling and weight reduction; an 11° competition crown; 1" diameter heavy profile under the handguard; custom match hybrid chamber with a tighter SAAMI Spec headspace from the shoulder of the chamber to the bolt face, and longer chamber throat or "Leade". This chamber accommodates 5.56mm ammunition without developing higher pressures encountered when firing 5.56mm ammo in a .223 chamber with shorter "Leade" (both calibers can be used safely). This Upper is sold complete with Bolt, Bolt Carrier and Charging Handle to ensure positive lockup between bolt and barrel extension. The Predator Upper also features a Vented Tubular Aluminum Free-Floater Forend with Bipod Stud (free-floats the barrel from the barrel nut forward) and B.M.A.S. 1/2" Mini-Risers to add scope height for correct sight picture and comfortable cheek weld.

Bushmaster Varminter 24" Upper Receiver/Barrel Assembly... \$760.00 (PURVMB 24FVAR9)



This Assembly - from our very accurate Varminter - features a 24" Fluted Extra Heavy Barrel in 5.56mm/.223 Rem. caliber with 11° competition crown; heavyweight 1" diameter under the handguard; custom match hybrid chamber with a tighter SAAMI Spec headspace from the shoulder of the chamber to the bolt face, and longer chamber throat or "Leade". This accommodates 5.56mm ammunition without developing higher pressures encountered when firing 5.56mm ammo in a .223 chamber with shorter "Leade" (both calibers can be used safely). Rifling is 1 in 9" twist for optimum performance with most lighter bullet weight varmint cartridges, and the barrel is fluted to increase cooling and reduce weight. The Varminter Upper's shell ejection path has been modified to drop all your brass in the same place as a convenience for the reloader. A vented forend with bipod/sling stud installed, free-floats the barrel from the barrel nut forward and B.M.A.S. Mini-Risers add 1/2" to scope height for correct sight picture and comfortable cheek weld. This Upper is sold complete with Bolt, Bolt Carrier and Charging Handle to ensure positive lockup between bolt and barrel extension.

"Varmint Special" Upper Receiver/Stainless Steel Barrel Assembly... \$760.00 (PURVMB 24-9SS)



This assembly features a brush finished 24" Barrel machined of 416 Stainless Steel (button rifled 1 in 9") as used on our Stainless Varmint Special Rifle. It includes a Free-floater Vented Tubular Forend with Bipod / Sling Stud installed, 1/2" B.M.A.S. Mini-Risers - with Bolt, Carrier, and Charging Handle - all ready for your lower.

Same Assembly without Bolt, Bolt Carrier Assembly and Charging Handle... \$610.00 (PURVM 24-9SS)

"Modular Carbine" Upper Receiver/Barrel Assembly... \$960.00 (Part# BURVMB 16FMC)



This is highly accessorized Upper Receiver/Barrel Assembly from our 16" Modular Carbine features a 16" Chrome Lined Chrome Moly Steel Fluted Barrel with Milled Gas Block. A Four Rail Free-Floater Tubular Forend combines with the A3 type "Flat-top" Upper Receiver to provide all the Picatinny rails necessary for mounting sights, scopes or accessories. Molded Rubber Sure Grip Rail Covers snap over the rail sections to add comfort and protection against heat buildup. The B.M.A.S. Rear Flip-up Sight is a dual aperture detachable unit with windage knob calibrated to 1/2 Minute of Adjustment. The B.M.A.S. Front Flip-up Sight clamps around the milled front gas block and incorporates an elevation adjustable front sight post - all ready for your lower receiver.

Also Available without Bayo. Lug or Suppressor (has Crowned Muzzle) \$960.00 (Part# PURVMB 16FMC)

Bushmaster Upper Receiver/Barrel Assemblies...

Bushmaster DCM Competition
Upper Receiver
/ Barrel Assembly
\$765.00



For the serious High Power Competitor – this Upper Assembly includes the competition modifications needed to win! See our Competition Section for details on this highly accurate 5.56mm/.223 Rem. Competition Upper Receiver/Barrel Assembly - features redesigned "Stay-Straight" dual detent rear sight with Competition Hood. As Bolt is matched to the Barrel Extension for utmost accuracy, this assembly is not sold without its matching Bolt & Carrier.



This Upper Receiver/Barrel Assembly is legal for installation only on weapons registered as Short Barreled Rifles or Pistols.

**11.5" Upper Receiver
/ Barrel Assembly
\$565.00** (BURA2B 11.5)

An ideal package for the Law Enforcement professional, its compact size offers easy handling in close quarters and squad cars. This assembly's short barrel length requires that these uppers be used on full automatics, or registered short barreled rifles or pistols. Configurations with the A3 "flat-top" upper receiver are also available at no extra cost (see Options - Pg. 25). The A2 "Birdcage" Suppressor is standard with this assembly, but other flash suppressors are also available as factory installed options.

Same Assembly less Bolt, Bolt Carrier Assembly & Charging Handle... \$415.00 (BURA2 11.5)



**11.5" Upper Rec. / Bbl. Assembly
with 5.5" Flash Suppressor
\$575.00** (BURA2B 11.5/5.5)

Our 5.5" CAR 15 Extended Flash Suppressor is pinned onto this 11.5" barrel, and welded to meet 16" total barrel length requirements. Choose A2 "handle style" Upper Receiver or A3 "flat-top" Upper Receiver - at same price (Note: A3 Removable Carry Handle is not included). To order, substitute "A3" for "A2" in Part # (see Options - Page 25).

Same Assembly less Bolt, Bolt Carrier Assembly & Charging Handle... \$425.00 (BURA2 11.5/5.5)

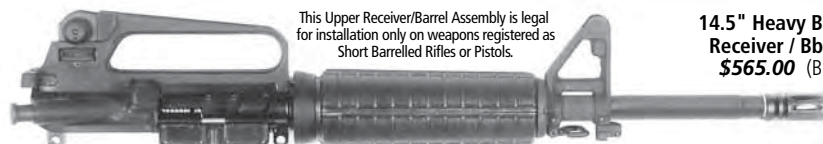

This Upper Receiver/Barrel Assembly is legal for installation only on weapons registered as Short Barreled Rifles or Pistols.

**14.5" Heavy Barrel Upper
Receiver / Bbl. Assembly
\$565.00** (BURA2B 14.5)

This lightweight carbine upper can be ordered with either the A2 Upper Receiver or the A3 "flat-top" style Upper (see Options - Page 25). The 14.5" barrel length makes this Upper legal for use only on weapons registered as pistols or full-automatic rifles. The chrome lined barrel is heavy profile in its full length, and the A2 birdcage suppressor is standard. Other flash suppressors / muzzle brakes are available as optional installations, and if permanently attached, and long enough to create a 16" overall barrel unit, this assembly would become legal for use on semi-automatic lowers.

Same Assembly less Bolt, Bolt Carrier Assembly & Charging Handle... \$415.00 (BURA2 14.5)

Bushmaster Upper Receiver/Barrel Assemblies with the ARMS S.I.R. Systems... Bushmaster offers a variety of complete Upper Receiver/Barrel Assemblies incorporating the ARMS S.I.R. System - all installed and ready for use. Many of our barrels can be ordered with the ARMS S.I.R. Systems - consult your Bushmaster Salesperson for details / pricing / part numbers.

See additional ARMS S.I.R. Systems in our Handguards Section of this catalog

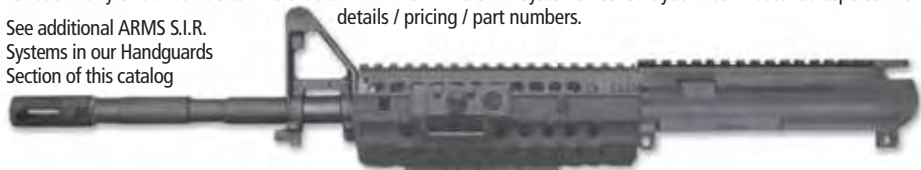

Bushmaster 14.5" Bbl. Upper with ARMS S.I.R. Model 50M-CV... \$980.00

Bushmaster Upper Receiver/Barrel Assemblies...

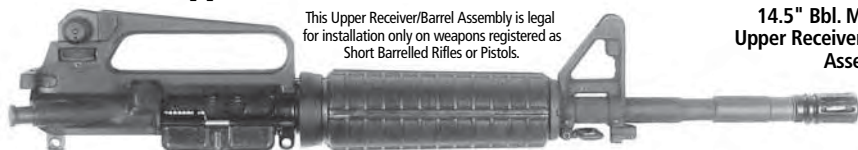

This Upper Receiver/Barrel Assembly is legal for installation only on weapons registered as Short Barrelled Rifles or Pistols.

14.5" Bbl. M4 Type Upper Receiver/Barrel Assembly...

One of our most popular Law Enforcement configurations, this light weight, chrome lined 14.5" barrel assembly has the "cutout" profile designed to mount the M203 Grenade Launcher. The A2 configuration is shown - see Options on Pg. 25 for ordering A3 versions (flat-top receiver - less carry handle).

14.5" M4 Type Upper Receiver/Bbl. Assembly... \$575.00 (with bayo. lug, A2 flash suppressor: Part# BURA2B 14.5M4)
Same Assembly Less Bolt, Bolt Carrier Assembly and Charging Handle... \$425.00 (Part# BURA2 14.5M4)



14.5" Upper Receiver/Bbl. Assembly with Permanent Izzy Suppressor...

Perfect for Three Gun Matches, Saturday plinking, or home protection, the 14.5" M4 Type Upper Receiver/Barrel Assembly becomes a legal 16" length barrel by permanently pinning/welding an Izzy Flash Suppressor, or other 2 3/16" long suppressors onto the barrel. They can be ordered in either A2 (carry handle) or A3 (flat-top) receiver versions (see Options - Pg. 25 for ordering information).

14.5" M4 Type Upper Receiver/Bbl. Assembly with Izzy Suppressor... \$605.00 (Part# BURA2B 14M4 IZ)
Same Assembly Less Bolt, Bolt Carrier Assembly and Charging Handle... \$455.00 (Part# BURA2 14M4 IZ)



With a lightweight, M4 profile barrel - stretched to 16" length - the Patrolman's Carbine is popular as a personal duty weapon with many L.E. Officers. See our Options listings - Pg. 25 - for ordering A3 "flat-top" versions (no extra charge).

16" Patrolman's Carbine M4 Type Upper Receiver/Barrel Assembly... \$575.00
 (With bayo. lug, threaded muzzle, A2 flash suppressor: Part# BURA2B 16M4 / With crowned muzzle/no lug: PURA2B 16M4)
Same Assembly Less Bolt, Bolt Carrier Assembly and Charging Handle... \$425.00
 (With bayo. lug, threaded muzzle, A2 flash suppressor: Part# BURA2 16M4 / With crowned muzzle/no lug: PURA2 16M4)



A2 Type Upper Assembly shown "Flat-top" A3 Type Uppers - see below

Dissipator 16" Bbl. Upper Receiver/Barrel Assembly...

This 16" Barrel configuration features full length handguards with aluminum heatshields to dissipate heat quickly. The front sight is placed so as to obtain the full sight radius designed into the M16A2 sight system.

Dissipator A2 Type Upper Receiver/Barrel Assembly... \$585.00 / "Flat-top" A3 Type... \$585.00
 with Bayo Lug, Birdcage Flash Suppressor (BURA2B 16D) / with Crowned Muzzle / No Bayo Lug (PURA2B 16D)
Dissipator A3 Type - Bayo Lug, Birdcage Flash Suppressor (BURA3B 16D) / Crowned Muzzle / No Bayo Lug (PURA3B 16D)
Same Assembly Less Bolt, Bolt Carrier Assembly and Charging Handle... \$435.00 ea.
 A2 Type With Bayo Lug, Birdcage Flash Suppressor (BURA2 16D) / with Crowned Muzzle / No Bayo Lug (PURA2 16D)
 A3 Type With Bayo Lug, Birdcage Flash Suppressor (BURA3 16D) / with Crowned Muzzle / No Bayo Lug (PURA3 16D)

Bushmaster Upper Receiver/Barrel Assemblies...



16" Heavy Carbine Upper Receiver/Barrel Assembly...

16" Heavy Carbine A2 Type Assembly

16" Carbine w. A3 Type Upper

Bushmaster's 16" chrome lined, heavy carbine barrels - headspaced, test fired, and ready for use - include short carbine handguards. Available with either A2 solid carry handle Upper Receiver or "Flat-top" (no carry handle) configurations (to order, change Part # to A3).

16" Heavy Barrel Carbine Upper Receiver/Barrel Assembly... \$565.00

(with bayo. lug, threaded muzzle, A2 flash suppressor: Part# BURAZB 16 / with crowned muzzle/no lug: PURAZB 16)

Same Assembly Less Bolt, Bolt Carrier Assembly and Charging Handle... \$415.00

(with bayo. lug, threaded muzzle, A2 flash suppressor: Part# BURAZ 16 / with crowned muzzle/no lug: PURAZ 16)

16" SuperLight Upper Receiver/Bbl. Assy - similar to above but with SuperLight Barrel (see Pg. 33)... \$575.00

(with bayo. lug, threaded muzzle, A2 flash suppressor: Part# BURAZB 16SL / with crowned muzzle/no lug: PURAZB 16SL)

Same Assembly Less Bolt, Bolt Carrier Assembly and Charging Handle... \$425.00

(with bayo. lug, threaded muzzle, A2 flash suppressor: Part# BURAZ 16SL / with crowned muzzle/no lug: PURAZ 16SL)



14.5" Bbl. AK Carbine Upper Receiver/Barrel Assembly...

14.5" AK Carbine with A2 "Carry Handle" Upper

14.5" AK Carbine with A3 Upper

Bushmaster's AK Type Muzzle Brake has been permanently fixed (pinned and welded) onto this assembly's 14.5" barrel, making it the 16" minimum legal length. Order it with either the A2 solid carry handle Upper Receiver or the A3 "flat-top" Upper at no extra cost (A3 Carry Handle is not included) - just substitute "A3" for "A2" in the Part #. This heavy profile, 14.5" barrel is chrome lined in both bore and chamber, and button rifled 1 turn in 9" - right hand twist.

14.5" Barrel - AK Carbine Upper Receiver/Barrel Assembly... \$585.00

(with bayonet lug and AK fixed muzzle brake: Part# BURAZB 14.5AK / with no bayonet lug: PURAZB 14AK)

Same Assembly Less Bolt, Bolt Carrier Assembly and Charging Handle... \$435.00

(with bayonet lug and AK fixed muzzle brake: Part# BURAZ 14.5AK / with no bayonet lug: PURAZ 14AK)

V Match Rifle & Carbine Upper Receiver/Barrel Assemblies... are defined by the "flat-top" Upper Receiver and a hard anodized, tubular, aluminum free-floater forend to offer accuracy and sight mounting versatility. Specify full or "milled" front sight base (milled shown), and threaded or crowned muzzle (both shown below).



20" Bbl. V Match Rifle Upper

16" Bbl. V Match Carbine Upper

20" Barrel - V Match Upper Receiver/Barrel Assembly... \$605.00

(with bayo. lug, threaded muzzle, A2 flash suppressor: Part# BURVMB 20AH / with crowned muzzle/no lug: PURVMB 20AH)

Same Assembly Less Bolt, Bolt Carrier Assembly and Charging Handle... \$455.00

(with bayo. lug, threaded muzzle, A2 flash suppressor: Part# BURVM 20AH / with crowned muzzle/no lug: PURVM 20AH)

24" Barrel - V Match Upper Receiver/Barrel Assembly... \$615.00

(with bayo. lug, threaded muzzle, A2 flash suppressor: Part# BURVMB 24AH / crowned muzzle/no lug: PURVMB 24AH)

Same Assembly Less Bolt, Bolt Carrier Assembly and Charging Handle... \$465.00

(with bayo. lug, threaded muzzle, A2 flash suppressor: Part# BURVM 24AH / with crowned muzzle/no lug: PURVM 24AH)

16" Barrel - V Match Upper Receiver/Barrel Assembly... \$605.00

(with bayo. lug, threaded muzzle, A2 flash suppressor: Part# BURVMB 16 / with crowned muzzle/no lug: PURVMB 16)

Same Assembly Less Bolt, Bolt Carrier Assembly and Charging Handle... \$455.00

(with bayo. lug, threaded muzzle, A2 flash suppressor: Part# BURVM 16 / with crowned muzzle/no lug: PURVM 16)

Bushmaster Upper Receiver/Barrel Assemblies...



20" A2 (Carry Handle) model shown with bayonet lug & flash suppressor.

20" & 24" National Match Target Model Upper Receiver / Barrel Assemblies... Rifled 1 turn in 9", these heavy profile, hard chrome lined barrels deliver Bushmaster accuracy for match competitors worldwide. The A2 Upper Receiver is complete (headspaced, test fired, and ready to snap onto your lower receiver) with dual aperture rear sight, charging handle, forward assist, ejection port cover, bolt, bolt carrier assembly and handguards.

20" Bbl. Target Model Upper Receiver/Barrel Assembly... \$565.00

(with bayonet lug, threaded muzzle, A2 flash suppressor: Part# BURA2B 20 / with crowned muzzle/no lug: Part# PURA2B 20)

Same Assembly less Bolt Carrier Assembly and Charging Handle... \$415.00

(with bayonet lug, threaded muzzle, A2 flash suppressor: Part# BURA2 20 / with crowned muzzle/no lug: Part# PURA2 20)

24" Bbl. Target Model Upper Receiver/Barrel Assembly... \$575.00

(with bayonet lug, threaded muzzle, A2 flash suppressor: Part# BURA2B 24 / with crowned muzzle/no lug: Part# PURA2B 24)

Same Assembly less Bolt Carrier Assembly and Charging Handle... \$425.00

(with bayonet lug, threaded muzzle, A2 flash suppressor: Part# BURA2 24 / with crowned muzzle/no lug: Part# PURA2 24)

20" & 24" Bbl. "A3" Target Model Upper Receiver / Barrel Assemblies...

Are also available at no additional cost. In the Part#, just substitute "A3" for "A2".



Bushmaster Stainless Steel Barreled Upper Receiver Assemblies...



These Bushmaster Stainless Steel Barrels are machined to our strictest standards.

A2 Carry Handle configuration... (PURA2B 20SS shown here)

We've had many requests to build Bushmaster accuracy in Stainless Steel configurations - just snap this complete assembly on your lower receiver and you're ready for the high power range. Assemblies are complete with Bushmaster forged Upper Receivers with Match Grade Polished Stainless Steel Barrels (1 in 9" right hand twist, button rifled). Stainless Barreled Assemblies are also available in A3 "flat-top" configurations at no extra charge. To order, change the A2 in Part # to A3. (Note: A3 Assemblies do not include A3 Removable Carry Handle. They have full front sight bases.)

20" Stainless Steel Bbl. Target Model Upper Receiver/Barrel Assembly... \$615.00

(with bayonet lug, A2 flash suppressor: Part# BURA2B 20SS / with crowned muzzle/no lug: Part# PURA2B 20SS)

Same Stainless Steel Assembly less Bolt Carrier Assembly and Charging Handle... \$465.00

(with bayonet lug, A2 flash suppressor: Part# BURA2 20SS / with crowned muzzle/no lug: Part# PURA2 20SS)

Bushmaster Carbon 15 .22 Rimfire Upper Receiver/Barrel Assembly...

A "dedicated" .22 Rimfire Upper Assembly that will fit Bushmaster Lower - and most AR15 Type Lower Receivers from other manufacturers. Switch over to economical .22 Long Rifle Ammunition to hone your shooting skills - add versatility to your rifle - and have fun "plinking". Chambered for .22 Long Rifle only, it operates in semi-automatic "blowback" mode. Inserts are included for use on Lower with A2 Buttstock, or Telestocked Lower, or with Bushmaster's Carbon 15 Lower Receiver. This assembly features a 16" Chromoly Steel Barrel (rifled 1 x 16"), a lightweight Titanium blowback bolt, and dual aperture rear flip sight (adjustable for windage) with square post front sight (adjustable for elevation). The Picatinny rail offers easy mounting of any scope, optic, red dot or laser sight.



(Also shown on Page 4)

Recoil Spring #AZ15912

Bolt Stop Assembly
#AZ15189

Buttstock Insert #AZ15789

10 Round Magazine
#AZ15280

Carbon 15 .22LR Upper Receiver/Barrel Assembly
\$387.00 # AZ15846K

Also, a 20" Barreled .22LR Rimfire Upper Receiver Assembly... \$469.95 (Part # AZ15847K)

Similar to above, but with Forged Aluminum A2 Upper; Full Length Handguards, and 20" Heavy (.750" diam.) Chromoly Steel Barrel - excellent for High Power Competition training.



w. Adapters & Mag.

Bushmaster Barrels... are the finest AR15/M16 type barrels made - machined from Chrome-Moly Vanadium steel - Rockwell C26 to 33 hardened. We also offer 20"/24" Heavy Profile Barrels machined from Stainless Steel. Most Bushmaster barrels are hard chrome lined (except the Stainless Steel barrels) to offer corrosion resistance in the bore and chamber. Chrome is more than twice as hard as barrel steel and effectively doubles barrel life with proper care (exactly why the military specifies the process). Chrome's lubricity (i.e. "slipperiness") reduces friction, increases velocity, aids in chambering, extraction, and speeds barrel cleaning. Bushmaster barrels are manganese phosphate finished (again except the Stainless) to guard against exterior rust or corrosion, and to provide the same matte black, non reflective finish found on quality military-type arms.

Rifling... Bushmaster barrels are button rifled with 6 grooves and lands (right hand twist, 1 turn in 9", except for DCM barrels - 1 in 8"). The 1 in 9" twist offers optimal results with the widest variety of commercially available ammunition. Most barrels are heavy profile their full length - to improve accuracy and alleviate barrel whip.

Forged Front Sights... Our front sights are machined steel forgings offering superior tensile strength. We do not use castings, which may crack or break if you accidentally drop your rifle.

Headspacing... Barrel assemblies are headspaced at the factory and are shipped ready for assembly and use. Barrel assemblies can be ordered with either a stepped, crowned muzzle or a threaded muzzle for attachment of a flash suppressor or muzzle brake. ATF rulings permit permanent factory installation of muzzle brakes/suppressors on barrels if the overall length (barrel & brake, etc.) equals at least 16". Ask your Bushmaster representative about factory installed muzzle brake / compensator / flash suppressor options available, or see Muzzle Brakes/Suppressors in this catalog.

"Barrel Only"... Bushmaster barrels can be purchased "Barrel Only" - which includes the barrel; barrel nut; handguard cap and complete front sight assembly with sight post and sling swivel as a savings to those shooters who already have handguards. **"Barrel Only" assemblies of 16" or longer length will not include flash suppressors - order those separately from our Muzzle Brakes / Suppressors / Compensators Section.**

Barrel Fluting... is the process of milling 6 grooves into the barrel's surface to increase cooling capability by increasing the barrel's surface area. Depending upon barrel length, fluting increases surface area by as much as 180% - and can reduce barrel weight by as much as 20%. Because of the extensive machining involved, order fulfillment on fluted barrels can take longer. Ask your sales representative about availability when ordering fluted barrels. To order your Bushmaster barrel with fluting, simply **ADD \$50.00** to the price of the barrel (or assembly), and add an **"F"** to the end of the part number. **Note: Fluting is not available on some barrels, such as the A2 Gov't. Profile, the M4 Type Barrel and some Stainless Steel Barrels. Fluting is included on our Varminter and Predator Barrels.**

Bushmaster "Short Barreled" Assemblies...



These chrome lined barrel assemblies may only be used on registered short barreled rifles, or full auto models for legality. They include barrel, sight, gas tube, delta ring kit, handguards, heat shields and A2 birdcage flash suppressor. **11.5" Barrel Assembly (above left) \$225.00** (A BBL-11.5A) / **11.5" "Barrel Only" \$195.00** (A BBL-11.5)

("Barrel Only" includes barrel, barrel nut, handguard cap and front sight - no flash suppressor).

14.5" Heavy Barrel Assembly (above right) \$225.00 (A BBL-14.5A) / **14.5" Heavy "Barrel Only"...** \$195.00 (A BBL-14.5) Assembly less handguards, gas tube, delta ring kit and flash suppressor.

NOTE: with a permanently installed Izzy Compensator, or other 2³/₁₆" suppressors, the 14.5" Heavy Barrel Assembly becomes a legal 16" barrel. Get details from your Bushmaster salesperson.



11.5" Heavy Barrel Assembly with 5.5" Flash Suppressor... \$240.00 (Part# A BBL-11.5WA) A chrome lined 11.5" barrel with 5.5" Flash Suppressor permanently attached (pinned and welded over) for a total length of 16" - making it legal for use on semi-auto rifles. Complete with Handguards, Gas Tube and Delta Ring (as shown here).



11.5" Heavy Bbl. with 5.5" Flash Suppressor - Barrel Only... \$210.00 (A BBL-11.5 W) Assembly shown less handguards, delta ring kit and gas tube.

11.5" Heavy Barrel Assembly with AK Muzzle Brake... \$255.00 A chrome lined 11.5" heavy barrel assembly with a 5.5" AK Muzzle Brake permanently attached to make a legal length 16" assembly. (With bayonet lug, pinned brake as shown here: Part# A BBL-11.5WAKA / without bayonet lug: Part# P BBL-11.5WAKA)

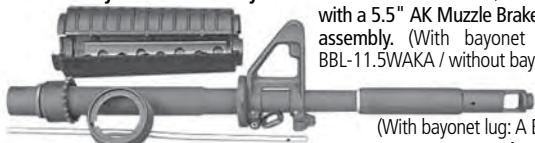

11.5" Heavy AK - Barrel Only... \$225.00 (With bayonet lug: A BBL-11.5WAK / without bayonet lug: P BBL-11.5AK) Assembly less handguards, gas tube and delta ring kit.

Bushmaster Barrels & Barrel Parts...

14.5" Heavy Barrel with AK Muzzle Brake... \$250.00 (With bayonet lug, pinned AK Brake [as shown here]: Part# A BBL-14.5AKA / without bayonet lug: P BBL-14AKA) A chrome lined 14.5" heavy barrel with our AK style Muzzle Brake permanently attached to 16" overall length for legality on semi-automatic weapons.

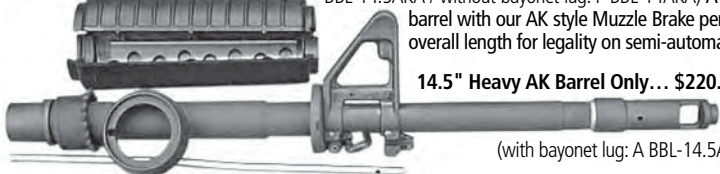

14.5" Heavy AK Barrel Only... \$220.00 Less Handguards, Gas Tube and Delta Ring Kit. Includes the AK Brake. (with bayonet lug: A BBL-14.5AK / without: P BBL-14AK)

Note: With an optional Izzy Brake/Compensator permanently installed, this becomes a legal 16" barrel.

14.5" M4 Type Barrel Assembly... \$235.00 (A BBL-14M4A) This Law Enforcement / Military carbine barrel is under the 16" legal minimum for semi-auto rifles, and can only be installed on registered full autos or legal short barreled rifles. It is machined for the addition of the M203 grenade launcher and has the narrow "government" profile under the handguards for light weight (like the original A1 rifle barrel).



M4 Type Barrel Only \$205.00 (A BBL-14M4) Assembly less Handguards, Gas Tube, Delta Ring Kit and Flash Suppressor.

14.5" M4 Type Barrel Assembly with Izzy Compensator... \$270.00 (With bayonet lug & compensator [as shown here]: Part# A BBL-14M4 IZFHA / without bayonet lug: Part# P BBL-14M4IZA) This assembly - with a factory pinned and welded Izzy Compensator - meets BATF requirements for total length (barrel and compensator) of 16" or over for semi-auto rifles. Includes Barrel, Sight, Handguards, Shields, Gas Tube, Delta Ring and Compensator - ready to assemble into that perfect 3 Gun Match carbine, plinker or home defense special.



14.5" M4 Type with Izzy Compensator - Barrel Only... \$240.00

(with bayonet lug: A BBL-14M4 IZFH / without: P BBL-14M4IZ)

14.5" M4 Type Barrel with AK Muzzle Brake... \$260.00 (With bayonet lug, pinned AK Brake [as shown here]: Part# A BBL-14M4AKA / without bayonet lug: P BBL-14M4AKA) A chrome lined 14.5" M4 type barrel with our AK style Muzzle Brake permanently pinned/welded to make overall length more than 16" for legality on semi-automatic weapons.



14.5" M4 with AK Muzzle Brake - Barrel Only... \$230.00

(with bayonet lug: A BBL-14M4AK / without: P BBL-14M4AK) Same assembly less handguards, gas tube and delta ring kit.

Patrolman's Carbine - M4 Type 16" Barrel Assembly... \$235.00 (With bayonet lug, threaded muzzle, A2 Birdcage Flash Suppressor [as shown here]: Part# A BBL-16M4A / without: Part# P BBL-16M4A) Featuring the light weight (2.14 lbs. for "Barrel Only") of the military M4 Type carbine in a 16" length, and the distinctive M4 profile, this assembly includes barrel, sight, handguards, shields, gas tube and delta ring kit. Other optional factory installed muzzle brakes/suppressors are available.



Patrolman's Carbine - Barrel Only... \$205.00

(with bayo. lug & threaded muzzle: A BBL-16M4 / without: P BBL-16M4) Assembly less handguards, gas tube, delta ring kit, & flash suppressor.

A variety of optional Muzzle Brakes and Flash Suppressors are available for these Barrels - See Pages 46 - 48.



A2 Birdcage
\$6.50

Izzy Compensator
\$36.95

Y Comp
\$48.95

Mini Y Comp
\$31.95

AK Brake
\$27.95

Phantom
\$36.95

Bushmaster Barrels & Barrel Parts...

16" Heavy Carbine Barrel Assembly... \$225.00 A complete barrel assembly including all parts from Upper Receiver forward: Barrel, Gas Tube, Handguards, Shields, Delta Ring Kit, Sight. (with Bayonet Lug, Threaded Muzzle, A2 Birdcage Flash Suppressor: Part# A BBL-16A / without bayonet lug or threaded muzzle: P BBL-16A)

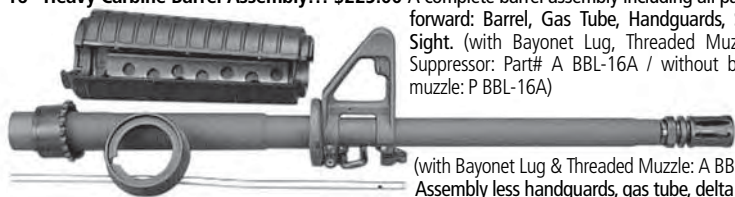

16" Heavy Carbine - Barrel Only... \$195.00

(with Bayonet Lug & Threaded Muzzle: A BBL-16 / without: P BBL-16) Assembly less handguards, gas tube, delta ring kit and suppressor.

Bushmaster SuperLight 16" Barrel Assembly... \$235.00 (with Bayonet Lug, Threaded Muzzle, A2 Birdcage Flash Suppressor [as shown below]: Part# A BBL-16SLA / without: P BBL-16SLA) The lightest 16" barrel we've ever offered -

tapers from .670" to .565" under handguards, .625" under sightbase, and to .570" at the muzzle - similar to the original Vietnam era A1 barrel profile. Note: due to diameter at muzzle, no "slip-on/pinned" type muzzle brakes will fit this barrel. Use only 1/2" x 28 T.p.i. threaded accessories.



Superlight 16" Assy. - Barrel Only... \$205.00

(with bayo. lug & threaded muzzle: A BBL-16SL / without: P BBL-16SL) Assembly less handguards, gas tube, delta ring kit and suppressor.

16" Dissipator Heavy Barrel Assembly... \$245.00 (with Bayonet Lug, Threaded Muzzle, A2 Birdcage Flash Suppressor [as shown below]: Part# A BBL-16DA / without: P BBL-16DA) A 16" chrome lined barrel with full length, heat shielded

handguards for excellent cooling and the full sight radius designed into the A2 sight system. Includes all parts forward of the Upper Receiver.



16" Dissipator Barrel Only... \$215.00

Assembly less Handguards, Gas Tube, Delta Ring and Suppressor.

(With Bayonet Lug, Threaded Muzzle: Part# A BBL-16D / Without: Part# P BBL-16D)

Dissipator M4 Type 16" Barrel Assembly... \$255.00 (with Bayonet Lug, Threaded Muzzle, A2 Birdcage Flash Suppressor: Part# A BBL-16DM4A / without [shown below]: P BBL-16DM4A) A lighter version of the Dissipator barrel design with an M4 type profile - retains the benefit of the full sight radius. Headspaced at the factory - includes all parts forward of the Upper Receiver.



Dissipator M4 Type - Barrel Only \$225.00

With bayonet lug & threaded muzzle: Part# A BBL-16DM4 - Without: Part# P BBL-16DM4

Assembly less handguards, gas tube, delta ring and suppressor.

M16A2 Type 20" Barrel Assembly... \$235.00 (With bayonet lug, threaded muzzle, A2 Birdcage: Part# A BBL-20A2A - Without bayonet lug, threaded muzzle, or A2 Birdcage Flash Suppressor: Part# P BBL-20A2A)



These Gov't. profile barrels - light in weight and reduced in diameter under the handguards are ideal for restoring that older rifle or building a new light-weight.

Complete barrel assemblies (as shown at left) include all parts from upper receiver forward (handguards, gas tube, delta ring kit, etc.)

M16A2 Gov't. Type 20" - Barrel Only... \$205.00

With bayonet lug & threaded muzzle: Part# A BBL-20A2



"Barrel Only" assemblies DO NOT include handguards, gas tube, delta ring kit or flash suppressor.

Without bayonet lug or threaded muzzle: P BBL-20A2

Bushmaster Barrels & Barrel Parts...

20" National Match Heavy Barrel Assembly... \$225.00 (w. Bayo Lug & Threaded Muzzle: A BBL-20A / without: P BBL-20A) Chrome lined in both Bore and Chamber, 1 x 9" Button Rifling and heavy profile, this complete assembly includes all parts forward of Upper Receiver: Handguards; Gas Tube; Delta Ring Kit, Front Sight, etc. all ready for assembly onto your Upper Receiver.



These barrels are now available with a variety of optional flash suppressors or muzzle brakes. Order from our Muzzle Brakes, Flash Suppressors/Compensators Section (Pgs. 46-48).

20" National Match Heavy Assembly - Barrel Only... \$195.00

(w. Bayo Lug & Threaded Muzzle: A BBL-20 / without: P BBL-20)



A Chrome Lined 20" Barrel same as immediately above, but without the Handguards, Gas Tube or Delta Ring Kit. "Barrel Only" does not include Flash Suppressor. Ask your Sales Representative about factory installed Muzzle Brakes / Flash Suppressors / Compensators.

24" National Match Heavy Barrel Assembly... \$235.00 (w. Bayo Lug & Threaded Muzzle: A BBL-24A / without: P BBL-24A)



24" Assy. "Barrel Only" ... \$205.00

Assembly without Handguards, Gas Tube

Delta Ring or Flash Suppressor. (w. Bayo Lug & Threaded Muzzle: A BBL-24 / without: P BBL-24)

Bushmaster 20" Stainless Steel Barrel Assembly... \$275.00 (P BBL-20SSA) Many of our High Power Competition customers have asked for Stainless Steel Barrels, and Bushmaster now manufactures this superbly accurate 20" Heavy Barrel. Machined of brush finished 416 Stainless Steel, in 1 in 9" twist, this Barrel Assembly comes complete with Front

Sight, Sling Loop, Handguard Set, Gas Tube, Delta Ring Kit and Barrel Nut - all ready to install on your Upper Receiver.



Front Sight is now available with Bayonet Lug - Please specify when ordering.

20" Stainless Steel Assembly - Barrel Only... \$245.00

(P BBL-20SS) Save money on a Stainless Steel Barrel upgrade - use existing Handguards, Gas Tube and Delta Ring.

24" Varminter Extra Heavy Fluted Barrel... \$391.95

from our very accurate "Varminter" Rifle (Part # P BBL-24FVAR9A)



Machined from finest Chrome Moly Vanadium Steel; fluted for light weight, and Manganese Phosphate finished. This non-chrome lined barrel is button rifled 1 x 9"; has a hybrid SAAMI Spec. chamber with longer throat or "Leade" to accommodate 5.6mm ammunition and is 1" diam. out to the gas block with an 11° competition muzzle crown; V Match Sight Base/Gas Block and Varminter Vented Forend. We recommend assembly onto your Upper Receiver by an experienced AR15 gunsmith to achieve full accuracy as parts are shipped unassembled.

24" Varminter Extra Heavy Fluted BARREL ONLY... (Part # P BBL-24FVAR9) \$313.95

Same Barrel as immediately above but less Varminter Vented Forend - shipped unassembled.

Includes Barrel, Bolt, Gas Tube and V Match Milled Gas Block.

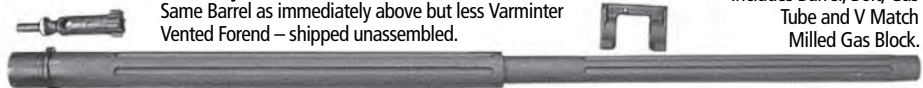

Bushmaster Barrels & Barrel Parts... 24" Stainless Varminter Barrel Assembly... \$391.95 (P BBL-24A-SS) A highly accurate 24" Barrel as used in our Stainless Varmint Special Rifle - brush finished 416 Stainless Steel, in 1 in 9" twist, this Barrel Assembly comes complete with Vented Aluminum Free-floater Forend, Sling Stud, Gas Block, Gas Tube, Bolt and Barrel Extension. Shipped unassembled - requires gunsmithing. Or 24" Stainless Varminter "Barrel Only"... \$313.95 (P BBL-24SS) Barrel Only includes: 24" Stainless Barrel with Gas Block, Gas Tube, Bolt and Barrel Extension.



Bushmaster DCM Competition Heavy Barrel with Factory Matched Bolt and Front Sight Base... \$313.95 (9349054-20CGA) A lapped 20" Barrel, button rifled in 1 x 8, features an 11° competition muzzle crown, and a custom match hybrid chambering with longer throat, or "Leade" to accommodate 5.56mm ammunition. This avoids the higher pressures developed when shooting 5.56mm ammo in a .223 caliber chamber that has a shorter "Leade" (both calibers can be safely used). Finest Chrome Moly Vanadium Steel with a Manganese Phosphate finish - full 1" diam. from the barrel extension forward to the sight base step. **Note: Requires Gunsmithing assembly to achieve optimum accuracy.**

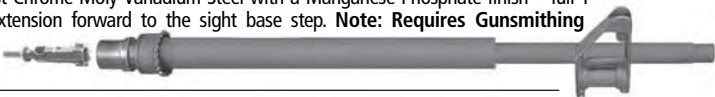

Bushmaster Stainless Steel Replacement Barrels for Carbon 15 Rifle & Pistols... Match Grade 416 Stainless Steel factory replacement barrels - 5.56mm/.223 - precision machined, polished and button rifled 1 turn in 9". These barrels require special torquing with a unique barrel wrench - Factory installation required (no charge).

Barrel for Carbon 15 R21 & Bushmaster Lady Rifles... \$159.95 (AZ15367)



Barrel for Carbon 15 R97 Rifle... \$209.95 (AZ15368) / for R97S & R97F Rifles... \$209.95 (AZ15368T)

P21 Pistol: \$139.95 (AZ15313) P97 Pistol: \$179.95 (AZ15314) P21S Pistol: \$139.95 (AZ15313T) P97S Pistol: \$179.95 (AZ15314T)



P21 Pistol

P97S Pistol

Bushmaster Barrel Parts... See Pages 40/41 for complete Schematic Parts Diagram
Gas Tubes... Quality materials and machining, properly bent for a perfect fit and flawless functioning in your rifle.
Gas Tube for RIFLE... \$14.95 (Part # 8448567) / Gas Tube for Carbine... \$12.95 (Part # 1005-914-3504)

Gas Tube Roll Pin... .50¢ (Part # MS16562-106)

Handguard Caps... \$6.50 ea. Manganese Phosphate finished steel Handguard Caps in three different types for Standard or Heavy profile barrels. **NOTE:** Rifle Length Handguards take the Triangular Cap / Standard Carbine Handguards take the Round Cap / M4 (Oval Profile) Carbine Handguards take either Round Cap (B. or C.).

- ...\$6.50 each For Standard Barrel For Heavy Barrel
- A. Triangular Cap... (Part # SGW-10) (Part # 9349053)
 - B. Round Cap... (Part # SGW-09) (Part # SGW-10F)
 - C. M4 Cap... notched for M203 (Part #SGW-10F-M)

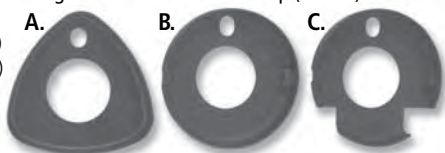

NOTE: Diameter of Standard Barrel = .625"
 Diameter of Heavy Barrel = .750"

Individual Delta Ring Parts...



All new, highest quality, Made in USA parts...

- A. Aluminum Delta Ring... \$7.50 (8448712)
- B. Handguard Weld Spring... \$5.25 (8448555)
- C. Handguard Snap Ring... \$2.75 (MS16626-1137)
- D. Gas Tube Roll Pin... \$.50 (MS16562-106)

Delta Ring Kit... \$13.95 (8448712K) Includes Aluminum Delta Ring, Handguard Weld Spring, Snap Ring and Gas Tube Pin (all parts as shown above).

Individual Barrel Parts...

- A. Front Sling Swivel... \$3.50 (8448571)
- B. Front Sling Swivel Rivet... \$.80 (8448697)
- C. Barrel Extension... \$15.95 (9349054BE)
- D. Barrel Nut... \$12.95 (9349054BN)



NOTE: Bushmaster DOES NOT sell Front Sight Bases separately due to difficulties of drilling/retro-fitting them to barrels.

HANDGUARDS & ACCESSORIES...

A2 Rifle Handguards... \$21.95/pair (9349059)

Compression molded of black composite polymer material (not injection molded - they will not melt during full auto fire). Non-reflective matte black finish designed to fit rifles with Triangular Handguard Cap. Include Internal Aluminum Heat Shields to protect hands from barrel heat buildup under rapid fire.

A2 Carbine Length Handguards... \$21.95/pair

(1005-914-4572) Same black composite polymer construction as above - heatshields included. These can only be used with the Round Handguard Cap (see Handguard Cap prices and part numbers - Page 35).

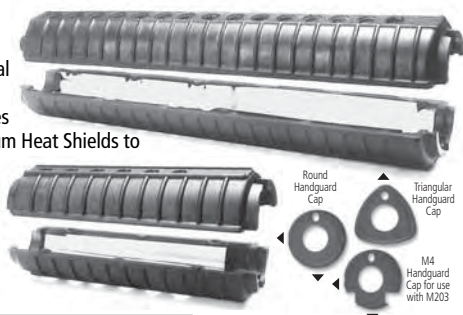

M4 Dual Heatshield Handguards... \$45.50/pair (1005-914-4574)

The M4 type Handguard is more oval in shape and taller in cross section, and the dual heatshields effectively increase barrel cooling - especially in rapid fire. This improved handguard set will fit most carbines with either type of round handguard cap. Molded of black thermoplastic composite material with heavy dual aluminum shields (one finished black/one silver).



Detail Photo of the Dual Heatshields

M4 Handguards with Single Heatshield ... \$42.50/pair (1005-914-4573)

Bushmaster DCM "Free-Floater" Kit - a Barrel Nut / Free-Floater Tube / Handguard Combination... \$159.95 (9349059CGA) Meets all regulations for DCM competition, this forend system free floats the barrel from Barrel Nut forward for optimum accuracy. A Sling Swivel Loop is mounted onto the front of the tube - Handguards, Delta Ring, Weld Spring, Snap Ring and a Special Gas Tube are included.

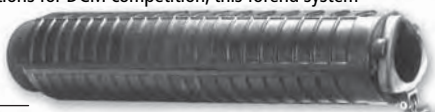

DCM Free-Floater Tube / Custom Gas Tube Set \$132.95 (2698823) Add your own rifle length handguards to this Competition free-float tube (minor modifications to handguards are required). Set includes a custom bent gas tube - Upper Rec. disassembly/Front Sight removal is required.



Vented Free-Float Tube Forend... \$95.95

(VAR-01K) This vented, free-floating, three piece forend can be easily installed on your rifle for improved accuracy - we use it on our Varminter and Predator Rifles. A new barrel nut and locking ring replace your existing barrel nut (front sight, gas tube and barrel nut removal required). The aluminum free-float tube screws on, and after "timing" the cooling vents, a locking ring holds it in position. The center of the tube is knurled for a non-slip grip, and a standard stud is included for bipod or sling. All three parts are high quality aircraft aluminum - black anodize finished. **Also available: .308 Free Floater Forend... For Rifles (VHG-3R) \$106.95 / For Carbines - Mid-Length (VHG-3M) \$101.95**



Bushmaster V Match "Free-Floater" Tubular Aluminum Forends... \$63.95

These hard anodized finished aluminum assemblies fit over standard and match profile barrels - "free floating" the barrel for optimum accuracy. Screwed directly onto the Upper Receiver replacing Handguards, Barrel Nut and Handguard Cap (requires removal of the front sight base - will not fit on Dissipator Barrels).



V Match Free-Float Forend For Rifles... \$63.95 (SGW-02) For Carbines... \$63.95 (SGW-01)

First Samco M44 Four-Rail Handguard Set... A quality Handguard Set by First Samco featuring four Picatinny Rails hidden under four removable rubber rail covers. The rails - positioned at 12-3-6-9 o'clock offer unlimited accessory attachment - the rubber covers add excellent grip comfort and protect the rails when not in use. Internal metal heat shields dissipate rapid fire heat. A handguard tool (see our HGD-Tool) is recommended for installation. Photo shows Carbine Set mounted with left side and bottom rubber covers removed.



First Samco M44 for Carbine... \$112.99 (FBS-M44S)

First Samco M44 for Rifle... \$136.99 (FBS-M44L)

HANDGUARDS & ACCESSORIES...

First Samco M-33 Handguard Set... \$89.95 (FBS-M33) The First Samco Two Rail Handguard Set for Carbines features integral Picatinny rails under removable covers. You can install this handguard set so as to position the rails vertically (12 and 6 o'clock) or horizontally (3 and 9 o'clock). Molded of high density black polymer, with stainless steel heat shields and comfortable rubber rail covers - available in Carbine length only - a direct snap-in replacement for standard guards.

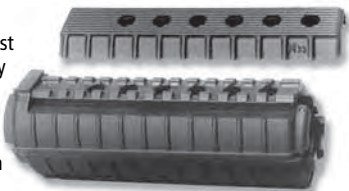

Bushmaster Modular Accessories System (B.M.A.S.) Integral Flat-top Forend... Fits the A3 type "flat-top" rifle or carbine, and mounts using a replacement barrel nut (included - major disassembly of rifle required). With the new barrel nut in place and aligned for the gas tube, the Forend slides onto the A3 Upper's rail, then locking screws and a "locking block" clamp it firmly in place. This system free-floats the barrel, offers four Picatinny Rails, and a sling mounting plate with swivel stud. Machined aircraft aluminum finished in matte black, hard anodized, and vented for minimum weight. **NOTE: The B.M.A.S. Low Profile Rear Flip-up Sight (YHM-9680) will fit behind this unit on the A3 Upper's rail.**

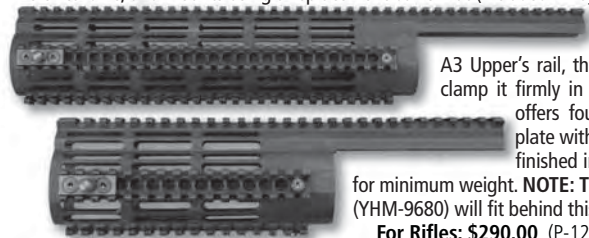

For Rifles: \$290.00 (P-12) / For Carbines: \$249.00 (P-4)

Bushmaster Modular Accessories System (B.M.A.S.) Four-Rail Free-Floater Handguard... The four Picatinny rails machined into these free floater forends offer unlimited mounting options for sights, scopes, grips, lights, lasers, etc. Venting slots all around aid in barrel cooling, and rail front edges are drilled and machined to accept the B.M.A.S. Swivel Sling Stud (Note: That stud would not function as a bipod mounting point). These forends are machined from aircraft quality aluminum and hardcoat anodized to mil. specs. The rifle model fits 20" and longer barrels; the carbine version is designed for 16" barrels. Assemblies include forearm, barrel nut and jam nut.

Note: Barrel/Front Sight disassembly is required for installation.

For Rifle... \$169.95 (YHM-9480)

For Carbine... \$148.95 (YHM-9479)

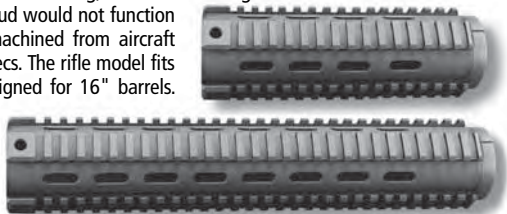

Bushmaster (B.M.A.S.) Four Rail Split Handguards... The "split" design of this handguard set allows easy installation of an accessory rail system on any AR type Rifle. Light weight and beautifully machined of aircraft aluminum, they snap in place of your standard carbine or rifle handguards, and offer full length Picatinny configuration rails for attachment of the flashlight/laser sight accessories of your choice. The rails are positioned at 12 - 3 - 6 - 9 o'clock, and the top handguard can be used in conjunction with an M203 Grenade Launcher. Thoroughly vented to keep your barrel cool, they are finished in mil. spec. matte black anodize to eliminate glare and protect against corrosion.

B.M.A.S. 4-Rail Split Handguard: Carbine Length... (YHM-9670) \$191.50 / Rifle Length... (YHM-9803) \$212.95

Sure-Grip Panels for Multi-Rail Forends... Black rubber grip panels for all rail forends - with Bushmaster logo molded in. They snap tightly onto the rails for protection and comfort.

A. Sure-Grip Full Length Rail Cover... \$10.95 ea. (SCH-6L) 5 3/4" long for full length coverage on carbine forends. Covers fifteen rail slots. Black rubber with 3 molded Bushmaster logos.

B. Sure-Grip 1/3rd Length Rail Cover... \$3.50 ea. (SCH-6) 1 3/4" black rubber grip panel (covers five rail slots) for Picatinny rail forends with BFI logo molded in.

Low Profile Rail Covers... These covers protect your hands from sharp rail edges; protect rail areas from damage and provide a very smooth, low profile appearance. Molded of Black Santoprene in two lengths - easily cut for custom applications.

A. Five Slot Low Profile Rail Cover... \$3.95 ea. (SCH-4370)

B. Full Length Low Profile Rail Cover... \$11.95 ea. (SCH-4373)

HANDGUARDS & ACCESSORIES...

Hogue Free-Floater Carbine and Rifle Forends...



A unique aluminum forend with a rubberized central band for comfort and insulation against heat and vibration. Installation requires removal of the front sight and barrel nut. The Two-piece Forend will fit our Dissipator models. Hogue Overmolded companion pistol grip is available.

Sold as a set with the Hogue Rubber Pistol Grip, or pieces priced individually:

Rifle Forend only... \$79.95 (15002)

2 Piece Rifle Set... \$106.95 (15003)

Carbine Forend only... \$79.95 (15004) Includes specially bent Gas Tube.

2 Piece Carbine Set... \$106.95(15013)

Pistol Grip only... \$31.95 (15000)

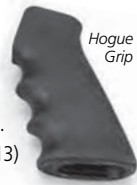

CAR & Rifle Length M203 Handguards... The bottom of these handguards are open to allow attachment of the M203 Grenade Launcher, and both are Gov't. issue, molded black nylon with internal aluminum heat shields. For installation, just snap them on in place of standard handguards.

CAR M203 Handguard... \$51.50 (Part # 12990563)

Rifle M203 Handguard... \$46.50 (Part # 8448377)



AR15/M16 Handguard Removal Tool... \$21.95 (HGD-Tool)

Provides the leverage needed to compress the weld spring inside the delta ring, and eliminates the need for a second person to help remove AR15/M16 handguards - used frequently at the Bushmaster plant. Strong, powder coated 1/4" round steel stock with protective vinyl coatings in all critical contact areas.



The **ARMS S.I.R. (Selective Integrated Rail) System** is a high quality, technical forend for the AR15 Type Carbine that combines barrel free-floating, light weight, and a multitude of accessory attachment rails. This #51C Slimline model in the ARMS S.I.R. System is intended to fit the A1/A2 Solid Carry Handle Carbines, leaves the barrel totally free-floating, and is approximately 1/4" narrower than other models for a more comfortable grip. The S.I.R. Model 51C clamps solidly onto the Upper Receiver's fixed carry handle (both the carry handle channel and the handle front support, utilizing two A.R.M.S.® self locking thumbnuts) to provide an extremely rigid, no movement fit. The extended bi-level rail platform will mount various scopes and red-dot or holographic sights, and offers the possibility of forward mounting optics to co-witness with the iron sights through the channel in the upper rail.

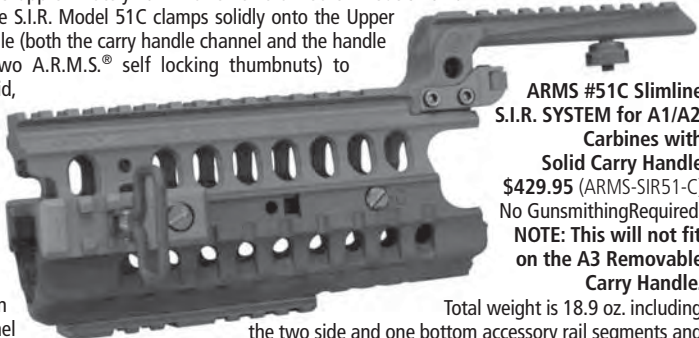

ARMS #51C Slimline S.I.R. SYSTEM for A1/A2 Carbines with Solid Carry Handle
\$429.95 (ARMS-SIR51-C)
No Gunsmithing Required.
NOTE: This will not fit on the A3 Removable Carry Handle.

Total weight is 18.9 oz. including the two side and one bottom accessory rail segments and sling swivel. These parts can be removed or added as needed.

NEW... A.R.M.S. #50 M-CV S.I.R. System ...Carbine length 5.56 cal. "Free-Float" system that can be installed in less than 5 minutes directly to the standard barrel nut (without the Delta Ring). The Front Sight, Gas Tube, Front Handguard Retaining Cap, Barrel, and Barrel Nut *do not* need to be removed for installation, and no special tools are required (the S.I.R. Std. Sling Swivel is useable for installation as it is ground with a "screwdriver blade" on its end). Perfect alignment with the receiver can be accomplished via built in alignment anti-rotation locking tabs. The 50 M-CV system weighs 8.6 oz., includes Q.D. indirect air flow heat shields and thoroughly vented for superior barrel cooling. Rail Segments at the 3, 6 and 9 o'clock positions can be exchanged, repaired or replaced without removing the top rail.

ARMS #50M-CV S.I.R. SYSTEM for A3 Carbines... \$319.00 (ARMS-50M-CV SIR)
No Gunsmithing Required.



See the Bushmaster Modular Accessories System (B.M.A.S.) section of this catalog for a complete line of parts and tactical accessories for multi-rail forends.

HANDGUARDS & ACCESSORIES...

B.M.A.S. Handguard Rails... Add accessories to any standard Rifle or Carbine handguard with these Anodized Aluminum Rails. Mounting requires removal of the handguards and inner shields - Rails fasten through the existing vent holes, and are tapered so that accessories mount on same plane as barrel and bore. Vent holes are aligned with existing handguard vents for proper barrel cooling. The Car Length Rail will fit on a Rifle length handguard if desired. Handguards have the possibility of movement, so we do not recommend installation of optics or lasers on these rails.

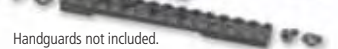

Handguards not included.

B.M.A.S. Rail for Rifle Handguard... \$60.50 (YHM-Hgd-Rail-Rif)

B.M.A.S. Rail for CAR Handguard... \$40.50 (YHM-Hgd-Rail-CAR)

SureFire G2™ Nitrolon® Flashlight... \$36.00 (G2-BK)

A compact (palm size) high-intensity incandescent flashlight for tactical, self-defense, and general use with a tough polymer body. Its smooth, brilliant, pre-focused tactical-level beam has four times the light of a two D-cell flashlight - bright enough to temporarily blind and disorient an opponent. Small size, light weight, and high output make it a perfect everyday-carry light. • Rugged, lightweight, corrosion-proof Nitrolon polymer body (Black Part Number listed here - Olive Drab, Tan or Yellow flashlights available on special order).

- O-ring sealed, weatherproof • Tailcap switch: press for momentary-on, twist for constant-on • Switch lockout prevents accidental activation during transport or storage • Max Output: 65 lumens
- Runtime: 60 minutes • Length: 4.90"/Weight: 4.1 Oz. • Battery: Two 123A Lithium

SureFire G2™ Nitrolon® Flashlight... \$36.00 ea. Black Body (G2-BK)



SureFire M79 Flashlight Mount... \$38.00 (M79) A sturdy aluminum and polymer mount that will clamp any 1" diam. flashlight (such as G2 above) to any rifle or carbine equipped with a Picatinny accessory rail. A heavy knurled thumbscrew clamps the unit onto the rail and flashlights are held with an adjustable cam-type locking clamp.



SureFire Scout Light M600B... \$310.00 (M600B) The two-battery Scout Light from SureFire clamps to any Picatinny rail by means of a sturdy, knurled thumb screw. An extremely rugged and powerful LED module produces 100 lumens of electronically-regulated light. A momentary-on remote tape switch is included.

- Batteries - Two SureFire Lithium SF123 3.0 Volt with 10-year shelf life • Output/Runtime - Max. Output of 100 lumens for 1 hour, then lower output for over 1.5 hours. Total runtime 2.5+ hours • Click on/off and momentary switch • MilSpec Type III hard-anodized aluminum



SureFire M910A-WH Vertical Foregrip Weaponlight...



The SureFire Millennium M910A Vertical Foregrip WeaponLight attaches to Picatinny rail interface-equipped weapons via a built-in dual thumbscrew mount. Each unit is equipped with five separate switches: (1) two pressure-sensitive momentary activation pads to control the main battle light - one on each side of the grip for ambidextrous operation (2) a constant-on switch (3) a system disable switch to lock the light in the OFF position for covert operations or to eliminate accidental light activation during storage, and (4) a third, smaller momentary switch to control two low-output LEDs that are useful whenever there is a need for a very small amount of light (stealth navigation, night-time breaching operations, etc.) **FEATURES** • Batteries - Three SureFire Lithium SF123 3.0 Volt (10 year shelf life) • Lamp Assembly/Runtime - SureFire MN10 Xenon/Halogen gas-filled lamp assembly with 125 lumens output for 60 minutes • Construction - Nitrolon® (non-conductive, impact-resistant, aramid glass-filled polymer) housing • Pyrex® lens window • Shock-isolated aluminum bezel with hard-anodized finish • Secondary, white LED navigation lights with separate switching • Flawless white beam, always in focus • Light output bright enough to temporarily blind an opponent **\$543.00 (M910A-WH)**

Rail Mount Switch Kit for Streamlight / SureFire Flashlight Pressure Switches...

\$12.95 (SCH-4366-KT) ...a 3 piece kit that will mount Streamlight or Surefire switches onto any Picatinny Rail section without adhesives or velcro. The base piece snaps onto the rail and the insert encapsulates the switch pad - molded black Santoprene Thermoplastic.



14.5" Barreled M4A3 Type Carbine - as shown here... (Order Part #QP-010B) Also available for 20" Barreled A2 Semi-Automatic Rifle... (Order Part #QP-010)

BUSHMASTER SCHEMATIC PARTS POSTERS - COLOR PRINTED ON 80# GLOSSY STOCK - \$4.95 PLUS SHIPPING

BARREL, HANDGUARD and FRONT SIGHT COMPONENTS IN THIS DISASSEMBLY GROUP

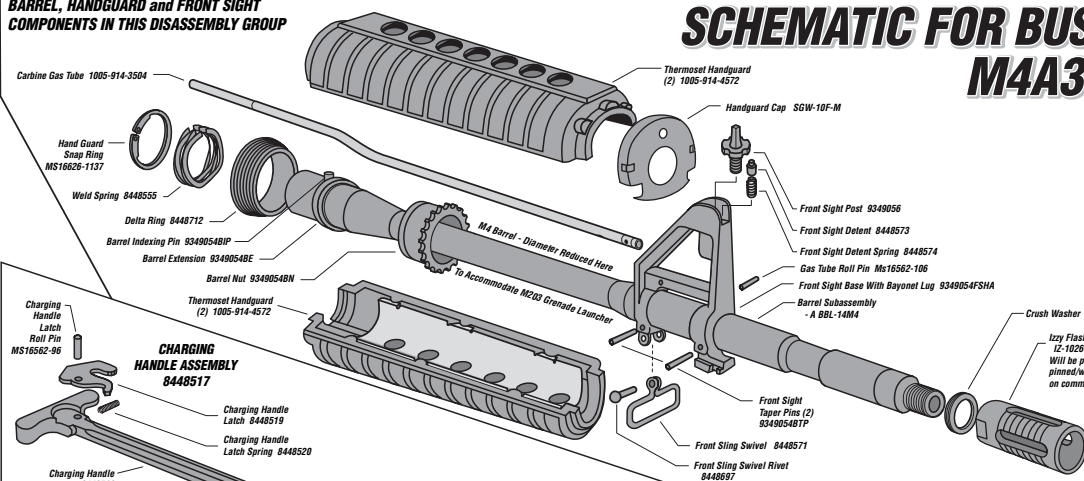

SCHEMATIC FOR BUSHMASTER M4A3 CARBINE

- Caliber: Chambered for NATO 5.56mm Also available .223 Remington
- Mode of Fire: Semi-Automatic
- 30 Round Magazine
- 34.75" Length Overall
- 14.5" Barrel Length
- Button Rifling - 1 X 9" Right Hand Twist
- Weight w/o Mag. 6 Lbs.

NOTE: THIS RIFLE IS ALSO AVAILABLE WITH THE FIXED A2 HANDLE TYPE UPPER RECEIVER

UPPER RECEIVER, BOLT AND BOLT CARRIER ASSEMBLIES / COMPONENTS

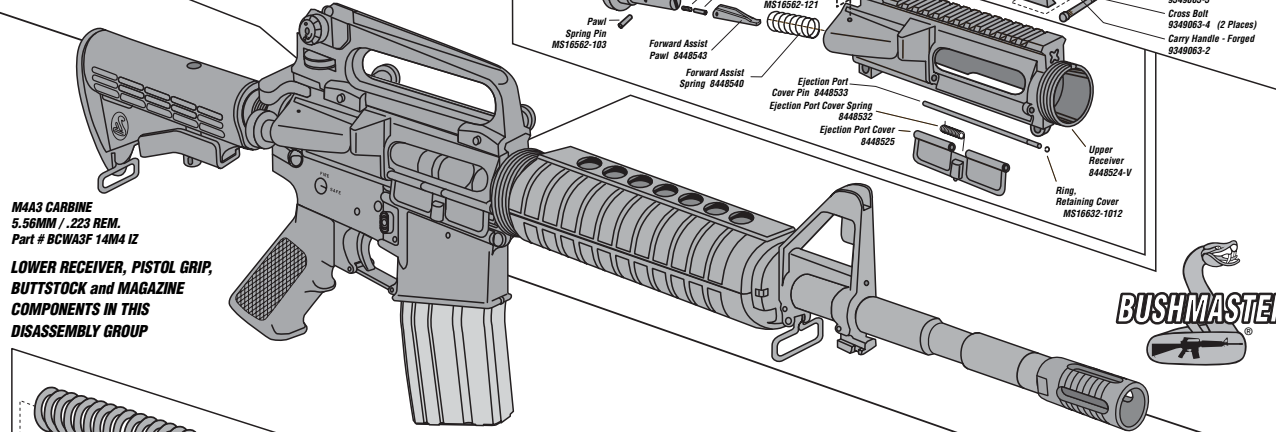
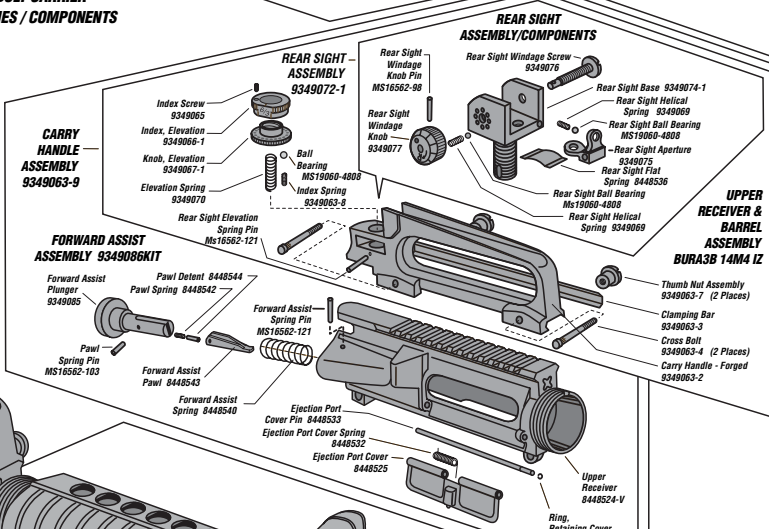
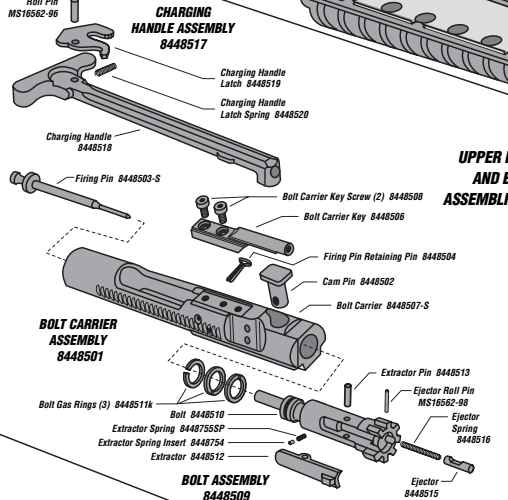

M4A3 CARBINE 5.56MM / .223 REM. Part # BCWA3F 14M4 IZ

LOWER RECEIVER, PISTOL GRIP, BUTTSTOCK and MAGAZINE COMPONENTS IN THIS DISASSEMBLY GROUP

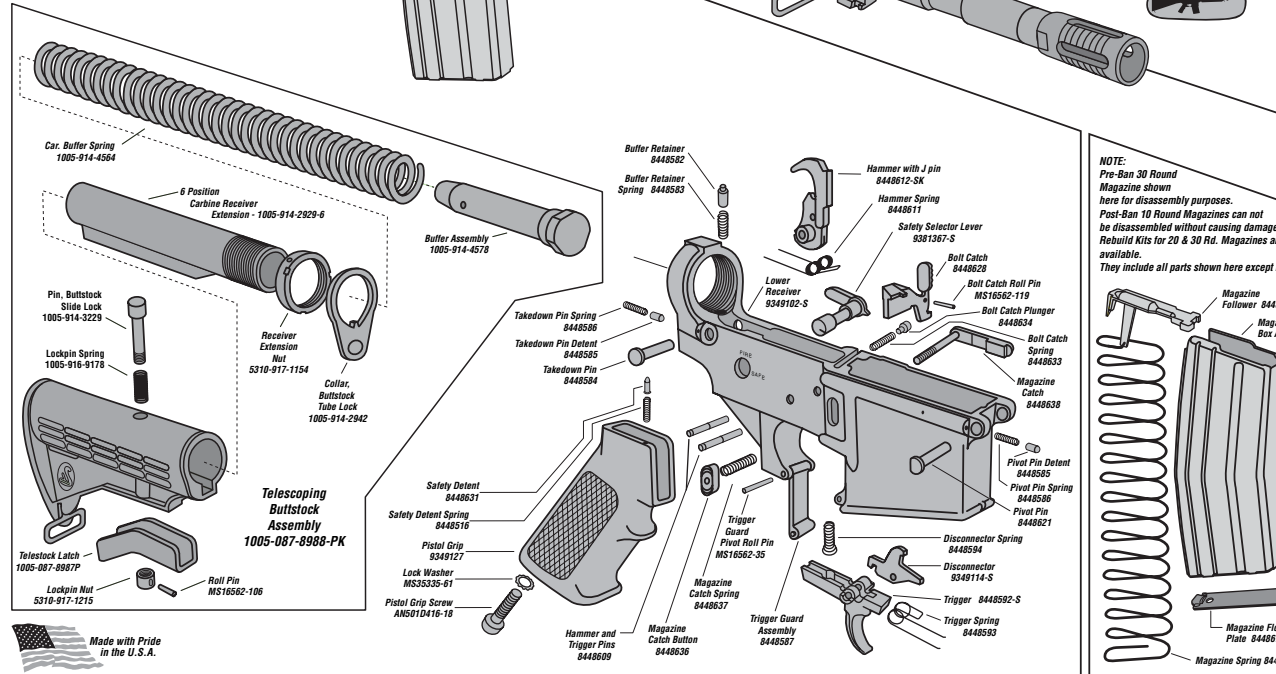

NOTE: Pre-Ban 30 Round Magazine shown here for disassembly purposes. Post-Ban 10 Round Magazines can not be disassembled without causing damage. Rebuild Kits for 20 & 30 Rd. Magazines are available. They include all parts shown here except box.



ORDERING INSTRUCTIONS / SHIPPING INFORMATION...

FOR FASTEST ORDER PROCESSING, visit our Website and order direct from our online catalog at...

http://www.bushmaster.com Our entire catalog is on the Internet - offering easy and secure ordering without waiting time on the phone! Many of our orders received via Internet are processed and shipped the same day (with the exception of back ordered items). Any orders that include E-mail addresses automatically get a return mail confirmation of shipment including the type of shipping service, a FedEx tracking number (if applicable), C.O.D. costs (if applicable), and notification of multiple packages. Customer Service and Technical Support inquiries can also be handled quickly and efficiently by E-mail. Contact us at:

Customerservice@bushmaster.com Techsupport@bushmaster.com Export@bushmaster.com

For Telephone Orders, Call: 1-800-998-7928

Sales Consultant Hours: Mon. through Fri. - 8:30 am - 7:00 pm / Sat. - 10:00 am - 3:00 pm
(Eastern Standard or Daylight Savings Time - all other hours of the day by answering machine)

For Orders by FAX: 1-207-892-8068 Customer Service: 1-800-883-6229

(Customer Service Phone Hours: Monday through Friday - 8:30 am - 6:00 pm)

All Catalog Prices are in U.S. Dollars - Please Pay in U.S. Currency

CATALOG PRICES ARE SUBJECT TO CHANGE WITHOUT NOTICE!

Current pricing can be seen on our website - www.bushmaster.com



Please Have Your Credit Card Available. We will NOT charge your credit card until we ship your order! FREE Gunsmithing and assembly is available on most AR15/M16 parts at the time of purchase. We accept purchase orders from Federal, State, and Local Governments and Institutions.



Bushmaster Firearms International, LLC • 999 Roosevelt Trail • P.O. Box 1479 • Windham, ME 04062 U.S.A.

SHIPPING... Orders will be shipped promptly via FedEx or First Class U.S. Mail. FedEx Ground is our standard method of shipment. FedEx Standard Overnight (1 Day); FedEx 2 Day and FedEx Express Saver (3 Day) Services are available upon request. All orders must be accompanied with Cash; Credit Card Information; Money Order or Cashier's Check or they will be shipped FedEx C.O.D. (C.O.D. to Continental U.S., Alaska and Hawaii - \$8.50 fee extra per package - FedEx will accept cash as payment). We request telephone numbers and/or E-mail address when you order to provide the best possible service in case of questions. In an effort to preserve your privacy, we do not sell our mailing lists. An F.F.L. (Federal Firearms License) is required for the purchase of Complete Rifles, serial numbered Lower Receivers, or M16 components. Other parts and accessories do not require special licenses. Personal checks are held 15 days to clear. No refunds after 15 days of invoice date. Returned parts will incur a 20% restocking charge.

NOTE: FedEx has a mandatory "Adult Signature Required" (21 yrs. or older) for all complete Firearms and Lower Receiver shipments. This Adult Signature Requirement is a FedEx regulation and cannot be waived.

PISTOLS: Federal Law requires that all pistols be shipped by Air Service. FedEx's mandatory "Adult Signature Required" (21 yrs. or older) will also be in effect.

DAMAGE: If your FedEx Package arrives damaged, you must alert the FedEx Driver, or call FedEx to notify them of damage problems and to initiate a claim. The FedEx toll-free national telephone line for this purpose is 1-800-GO-FEDEX.

INTERNATIONAL ORDERS... Due to the costs of international order processing, Bushmaster will only accept international orders valued at \$500.00 or more. Bushmaster has established dealers in countries outside the U.S.A., please contact them for your Bushmaster product needs if less than this \$500.00 minimum.

For Shipping Parts Only...

Shipping, Handling & Insurance Charges for FedEx Ground Service or U.S. Mail are:

\$0.00 - \$19.99 = \$6.50 / \$20.00 - \$49.99 = \$9.00 / \$50.00 - \$99.99 = \$11.50

\$100.00 - \$249.99 = \$14.50 / \$250.00 - \$499.99 = \$18.00 / \$500.00 and up = \$21.00

For Shipping Complete Firearms...

Standard Rifle - FedEx Ground - \$16.50 ea. / DCM Rifle - FedEx Ground - \$19.50
Pistols - BY LAW - must be shipped by Air Service.





Free Shipping on backordered "Parts" only. Shipping Charges on parts orders over 20 lbs. will be calculated by weight only using our Fedex published rates plus insurance of .50¢ per \$100.00 value.

FedEx C.O.D. Fee - \$8.50 per package. NOTE: FedEx will accept cash as payment for C.O.D.s

FedEx Standard Overnight (1 Day); FedEx 2 Day and FedEx Express Saver (3 Day) Services are available upon request.

Ship To:

Name: _____ Customer No.: _____
 Address: _____ (If available - see catalog label)
 City: _____
 State: _____ ZIP: _____
 Telephone Number: () _____ E-mail Address (if available) _____

Phone # and Email are optional. However, if any questions arise about your order, this will assist us in its speedy processing.
 Method of Payment: Check or Money Order Enclosed (Personal Checks are held for 15 Days to Clear.)
 MasterCard  VISA  American Express  Discover  C.O.D.*
 ALL CREDIT CARD ORDERS MUST INCLUDE PHONE NUMBER AND MUST BE SHIPPED TO ADDRESS WHERE CARDHOLDER RECEIVES CREDIT CARD BILLING.
 If payment is made with Gift Certificate, please include Certificate Number: _____

Credit Card Account No.: _____ Date of Expiration: _____

Customer's SIGNATURE: _____

Ship Via: FedEx Ground (our standard method - other services available) *FedEx C.O.D. is available. Cash payment is accepted.
 U.S. Mail - PARCEL POST (No C.O.D.s*)

Have you ordered from us before? Yes No Would you like to receive future catalogs?

| PAGE NO. | QTY. | PART NO. | DESCRIPTION | PRICE EACH | AMOUNT |
|----------|------|----------|-------------|------------|--------|
| | | | | | |
| | | | | | |
| | | | | | |
| | | | | | |
| | | | | | |
| | | | | | |
| | | | | | |
| | | | | | |
| | | | | | |
| | | | | | |
| | | | | | |
| | | | | | |
| | | | | | |
| | | | | | |
| | | | | | |
| | | | | | |
| | | | | | |
| | | | | | |
| | | | | | |
| | | | | | |
| | | | | | |
| | | | | | |
| | | | | | |

Shipping, Handling & Insurance Charges for Parts only - FedEx Ground Service or U.S. Mail: SUBTOTAL
 Other FedEx Services are available at extra cost - consult your salesperson.

| | | |
|-----------------------------|-------------------------------|----------------------------------|
| \$ 0.00 - \$19.99 = \$ 6.50 | \$100.00 - \$249.99 = \$14.50 | Maine Residents Add 5% Sales Tax |
| \$20.00 - \$49.99 = \$ 9.00 | \$250.00 - \$499.99 = \$18.00 | Shipping, Handling & Insurance |
| \$50.00 - \$99.99 = \$11.50 | \$500.00 and up.... = \$21.00 | |

Standard Rifle - FedEx Ground - \$16.50 ea. / DCM Rifle - FedEx Ground - \$19.50 TOTAL AMOUNT
 Pistols must be shipped by Air Service. Shipping will be free on backordered "Parts" only.
 Shipping Charges on parts orders over 20 lbs. will be calculated by weight only using our FedEx published rates plus insurance of .50¢ per \$100.00 value.
 FedEx C.O.D. Fee - \$8.50 per package. (Note: FedEx will accept cash as C.O.D. payment.)
 Call about orders to Hawaii, Alaska and U. S. Territories. We can only ship Pre-Paid via U.S. Mail to Puerto Rico.

SATISFACTION GUARANTEED, OR YOUR MONEY BACK. 999 Roosevelt Trail • P.O. Box 1479
PRICES ARE SUBJECT TO CHANGE WITHOUT NOTICE. Windham, Maine 04062 U.S.A. 

Customer Service, Exchanges, Backorders, Gunsmithing, Bushmaster Warranty...

NOTE: With the "Sunsetting" of the Gun Legislation of 1994, many features of "Pre-Ban" rifles are again available - BUT not in all areas! California, Connecticut, Hawaii, Massachusetts, Maryland, New Jersey, New York, Puerto Rico, and possibly others, all have their own Statutes regarding what they call "Assault Weapons". To avoid the possibility of legal problems, check your local laws before purchasing some items offered in this catalog.

CUSTOMER SERVICE... Our telephone personnel are highly experienced and well informed firearms enthusiasts. If you have any questions about Bushmaster products, you'll find a courteous member of our firm willing and able to answer them - just call our **Toll-Free Customer Service line (1-800-883-6229)** between 8:30 am - 6:00 pm, Monday through Friday, (E.S.T.). We will also be happy to promptly answer your questions, or order inquiries, via E-mail to: **Customerservice@bushmaster.com**

EXCHANGES... Should items you order from Bushmaster not be to your expectations, please contact our customer service department for a **Return Merchandise Authorization (RMA) Number**. Unused items may be returned within 30 days, include a copy of your invoice. **Note: Any Custom Barrel Assembly - not shown in catalog - may not be returned.** No refunds allowed after 15 days of invoice date. Restocking charge 20%. Include invoice with your return - its upper left corner can be used as return label. Return all pieces of kits - wrap and package them securely. Insure package for your protection. Include the reason for return of each item in an accompanying letter and we will do everything possible to speed your exchange.

BACKORDERS... We make every attempt to deliver your order from available stock - immediately. Should there be a backorder on a part, we'll ship the bulk of your order and WE pay the shipping on the backordered part (with the exception of complete rifles). FedEx Standard Overnight (1 Day); FedEx 2 Day and FedEx Express Saver (3 Day) Services are available upon request at additional charge. For C.O.D. Service from FedEx, please add \$8.50 per package (**Note: FedEx will accept cash as C.O.D. payment**).

BUSHMASTER GUNSMITHING... Our company policy is to offer **gunsmithing assembly at no charge when parts are purchased from us** (with the exception of sight bases). We will also offer our professional gunsmithing services to any customers who care to ship us their firearms or assemblies for repair or buildup - and we will work on brands other than Bushmaster. Gunsmithing time is charged at \$40.00 per hour, and we charge a \$16.50 fee for return shipping of your rifle, upper or parts (\$19.50 for DCM Rifles due to extra weight). For a gunsmithing estimate, please call **1-800-998-7928** or E-mail to: **Techsupport@bushmaster.com**

BUSHMASTER LIMITED ONE YEAR WARRANTY... Bushmaster Firearms are warranted to be free from defects in materials and workmanship. Any such defect of which Bushmaster Firearms International, LLC is given written notice, as provided below, within one year and ten days from the date of first purchase by a customer will be remedied by Bushmaster Firearms International, LLC. This warranty is granted by **Bushmaster Firearms International, LLC, P.O. Box 1479, 999 Roosevelt Trail, Windham, Maine 04062.**

To initiate a Warranty claim, call Bushmaster Customer Service (toll free: 8:30 AM to 6:00 PM E.S.T. - Monday thru Friday **1-800-883-6229**) to get an RMA number ("Return Merchandise Authorization"). Warranty claims should state (in writing) the model and serial number of the firearm concerned, a description of the difficulty experienced, and the date of purchase. The firearm concerned should be shipped (transportation charges prepaid), to the **Warranty Service Department, Bushmaster Firearms International, LLC, 999 Roosevelt Trail, Windham, ME 04062.** Firearm shipment should be insured by the owner, as **Bushmaster Firearms International, LLC will accept no responsibility for loss or damage in transit.**

Shipping and insurance charges for the return of a firearm to its owner will be paid by Bushmaster Firearms International, LLC if the related claim is a proper claim for warranty work.

Under no circumstances shall Bushmaster Firearms International, LLC be responsible for incidental or consequential damages with respect to economic loss or injury to property, whether as a result of express or implied warranty, negligence or otherwise. Some states do not allow the exclusion of limitation of incidental or consequential damages, so the above limitation may not apply to you. Bushmaster Firearms International, LLC will not be responsible for the results of careless handling, unauthorized adjustments, defective, low quality, reloaded, or improper ammunition, corrosion, neglect, ordinary wear and tear, or unreasonable use. Furthermore, the liability of Bushmaster Firearms International, LLC under this warranty shall be limited solely to the obligation to repair or replace the firearm, and to pay transportation and insurance charges for return of the firearm to owner.

NOTE: Handguns and long guns are classified as FIREARMS or DANGEROUS WEAPONS. Guns are surrendered by Bushmaster Firearms International, LLC with the express understanding that it assumes no responsibility for resale handling under local laws and regulations.

A NOTE REGARDING LEAD... Discharging firearms in poorly ventilated areas, cleaning firearms, or handling ammunition may result in exposure to lead, a substance known to cause birth defects, reproductive harm, and other serious physical injury. Have adequate ventilation at all times. Wash hands thoroughly after exposure to lead.

Phone Orders: 1 800 998 7928 44 Internet: www.bushmaster.com

Ship To:

Name: _____ Customer No.: _____

Address: _____ (if available - see catalog label)

City: _____

State: _____ ZIP: _____

Telephone Number: () _____ E-mail Address (if available) _____

Phone # and Email are optional. However, if any questions arise about your order, this will assist us in its speedy processing.

Method of Payment: Check or Money Order Enclosed (Personal Checks are held for 15 Days to Clear.)

MasterCard  VISA  American Express  Discover  C.O.D.*

ALL CREDIT CARD ORDERS MUST INCLUDE PHONE NUMBER AND MUST BE SHIPPED TO ADDRESS WHERE CARDHOLDER RECEIVES CREDIT CARD BILLING.

If payment is made with Gift Certificate, please include Certificate Number: _____

Credit Card Account No.: _____ Date of Expiration: _____

Customer's SIGNATURE: _____

Ship Via: FedEx Ground (our standard method - other services available)

**FedEx C.O.D. is available. Cash payment is accepted.*

U.S. Mail - PARCEL POST (No C.O.D.s*)

Have you ordered from us before? Yes No Would you like to receive future catalogs?

| PAGE NO. | QTY. | PART NO. | DESCRIPTION | PRICE EACH | AMOUNT |
|----------|------|----------|-------------|------------|--------|
| | | | | | |
| | | | | | |
| | | | | | |
| | | | | | |
| | | | | | |
| | | | | | |
| | | | | | |
| | | | | | |
| | | | | | |
| | | | | | |
| | | | | | |
| | | | | | |
| | | | | | |
| | | | | | |
| | | | | | |
| | | | | | |
| | | | | | |
| | | | | | |
| | | | | | |
| | | | | | |
| | | | | | |

Shipping, Handling & Insurance Charges for Parts only - FedEx Ground Service or U.S. Mail: **SUBTOTAL**
 Other FedEx Services are available at extra cost - consult your salesperson.

\$ 0.00 - \$19.99 = \$ 6.50 \$100.00 - \$249.99 = \$14.50
 \$20.00 - \$49.99 = \$ 9.00 \$250.00 - \$499.99 = \$18.00
 \$50.00 - \$99.99 = \$11.50 \$500.00 and up.... = \$21.00

Maine Residents Add 5% Sales Tax
 Shipping, Handling & Insurance

Standard Rifle - FedEx Ground - \$16.50 ea. / DCM Rifle - FedEx Ground - \$19.50
 Pistols must be shipped by Air Service. Shipping will be free on backordered "Parts" only. **TOTAL AMOUNT**

Shipping Charges on parts orders over 20 lbs. will be calculated by weight only using our FedEx published rates plus insurance of .50¢ per \$100.00 value.

FedEx C.O.D. Fee - \$8.50 per package. (Note: FedEx will accept cash as C.O.D. payment.)

Call about orders to Hawaii, Alaska and U. S. Territories. We can only ship Pre-Paid via U.S. Mail to Puerto Rico.

SATISFACTION GUARANTEED, OR YOUR MONEY BACK.

PRICES ARE SUBJECT TO CHANGE WITHOUT NOTICE.

999 Roosevelt Trail • P.O. Box 1479
 Windham, Maine 04062 U.S.A



COMPENSATORS / FLASH SUPPRESSORS / MUZZLE BRAKES...



IZ-102660-FH

Bushmaster "Izzy" Flash Suppressor/Compensator... \$36.95 (IZ-102660-FH) One of a series designed by a Bushmaster employee - features 3 gas ports, a machine turned ribbed design, and a closed bottom. It is bored to function as a Flash Suppressor, but also effectively controls muzzle rise in rapid fire. Quality gunsteel - manganese phosphate finished - 2 3/16" overall length - threaded 1/2" x 28 T.p.I. (threads per inch) for 5.56mm/.223 Rem. caliber barrels. Install using a 3/4" open end wrench and a crush washer or peel washer.

And, for plain muzzle 5.56mm/.223 caliber "Post-Ban" guns - **Bushmaster "Izzy" Flash Suppressor/Compensator... \$36.95** (IZ-102660-SFH) Same design as above, but slips over muzzles of .700" diameter and is held in place with a taper pin and high strength Loctite® for extra safety. Warning: This Compensator requires factory installation, or professional gunsmithing, to drill and install the taper pin.



IZ-102660-SFH



For Threaded Muzzles... 2 3/16" Length

Bushmaster Izzy Muzzle Brake... A 5.56mm/.223 Caliber Muzzle

Brake - production approved by the BATF - featuring four gas ports and a ribbed design to improve cooling. Machined of 4140 gun steel with a manganese phosphate finish - very effective in controlling muzzle rise. Slip-on/taper pinned version for barrels with plain crowned muzzles, and threaded model (shown left - threaded 1/2" x 28 T.p.I.) can be installed without regard to port location (timing) and will still be effective, however most are installed with ports positioned 12 - 3 - 6 - 9 o'clock. The slip-on, pinned version requires factory installation or professional gunsmithing to drill and install the taper pin, and for extra safety, high strength Loctite® should be used in addition to the taper pin.



For Plain Crowned Muzzles 2 5/8" Length

Bushmaster Izzy Brake... for threaded barrels - requires lock washer... \$36.95 (IZ-102660-PRBF)

Bushmaster Izzy Brake... for plain muzzles .700" diameter - requires gunsmithing... \$36.95 (IZ-102660-PSTF)

Bushmaster Izzy Brake... for .308 Cal. threaded barrels - requires crush washer... \$36.95 (IZ-308-PRBFH)

Phantom 2 Flash Suppressor... \$36.308.95 (YHM-28-5C1) An improved version of the Phantom Flash Suppressor - without a bottom slot to avoid a dust signature when firing prone - superior flash hiding with excellent performance in all conditions. For standard muzzles (1/2" x 28 T.p.I.), machined from quality gun steel with a final phosphate coating to mil. specs. Overall Length is 2 3/16" - flats allow installation with a 3/4" wrench. **NOTE:** A Crush Washer or Peel Washer is required for correct timing (see next page).



Phantom Flash Suppressor... \$36.95 (YHM-29) Precision CNC machined from quality gun steel and phosphate coated to military standards, this "five port" flash suppressor (5 gas slots equally spaced) eliminates all flash and offers excellent performance with night vision equipment. This design offers superior strength to the earlier forked type, and it won't hang up on brush or clothing. 2 3/16" Overall - for threaded muzzles only (1/2" x 28 T.p.I.). Does not require specific timing, so no Crush or Peel Washer is required.

A2 Bird Cage Flash Suppressor... \$6.50 (9349051)

Standard 5 Slot Design for threaded muzzles (1/2" x 28 T.p.I.) without a bottom slot so it won't create a dust signature when firing from the prone position. A Peel Washer or Crush Washer is required for correct installation timing. **Note:** Even if pinned on/welded over, the A2 Birdcage Flash Suppressor is NOT long enough to make a 14.5" barrel legal for use on a semi-auto rifle.



1 3/4" overall length

A1 Bird Cage Flash Suppressor... \$6.50

(8448576) Original "Birdcage" from the Viet Nam era, this suppressor has six equally spaced slots all around - needs no specific slot timing. Standard 1/2" x 28 T.p.I. threading. For installation use the Flash Hider Lock Washer.



1 3/4" overall length

A1 Flash Hider Lock

Washer... .60¢ (8448577)



Russian Design AK74 Type Muzzle Brake... A 5.56/.223 caliber copy of the very effective Russian Military brake found standard on the AK74 Rifle. Screws onto threaded muzzle barrels and locks in place with an Allen head set screw (Note: a peel washer is required for correct timing during installation). 3" overall length. Muzzle climb is controlled by three upper gas ports - recoil is diminished by four 45° ports directing gas at an angle from the weapon, and a contoured flat at the end of the brake directs gas sideways. The "Post-Ban" model slips over non-threaded muzzles (.700" diam.) and pins in place (taper pin included).

For Threaded Muzzles...

\$27.95 (MMT-0012A)

Fits standard threaded barrels - 1/2" x 28 T.p.I.



"Post-Ban" Model for NON-Threaded Muzzles

\$27.95 (MMT-0012PB) Requires taper pin drilling / pinning. Bushmaster factory installation is recommended.



MUZZLE BRAKES / COMPENSATORS / FLASH SUPPRESSORS...

5.5" AK74 Muzzle Brake for 5.56mm/.223

Carbines... \$31.95 (MMT-0013) A very functional muzzle brake for the short barrelled carbine - 5.5" overall

length, when permanently installed on the 11.5" barrel, makes a legal 16" barrel length. Peel washer included for "timing" (positioning of brake on muzzle). Threaded to fit standard muzzles: 1/2" x 28 T.P.I.



"CAR 15" Flash Suppressors... High quality, manufactured in the U.S.A. - the six slot design makes these suppressors very effective on the short barrelled carbine.

For threaded barrels only (1/2" x 28 T.P.I.).

A. CAR 15 Extended Flash Suppressor... 5.5" overall - threaded for all Pre-Ban barrels \$15.95 (MMT-500)

B. Shorty Look Slipover Flash Suppressor... Internal threads allow a "slip-over" installation onto barrel - giving your gun a "shorty" look without sacrificing accuracy. 5" overall

For Std. Diameter Barrels (.610" at muzzle)... \$15.95 (MMT-0019)

For Heavy Diameter Barrels (.720" at muzzle)... \$20.95 (93495FSH)

C. CAR 15 "Original" Flash Suppressor... This is the original 4.5" M177 carbine design. \$15.95 (1005-914-3902)

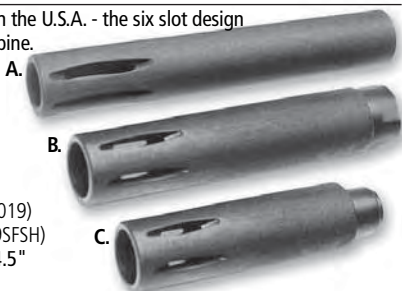

Y COMP and Mini Y COMP Muzzle Brake for threaded muzzle barrels...

These 5.56mm/.223 compensators are threaded to fit "Pre-Ban" AR barrels. The

Y Comp overall length is 3 1/4" - the Mini Y Comp is 2 5/16" overall length.

Order either a Crush Washer or Peel Washer for installation. These brakes are for barrels with muzzles threaded 1/2" x 28 T.P.I. (threads per inch).

Y COMP Brake... \$48.95 (YHM-258) or Mini-Y COMP Brake... \$31.95 (YHM-259)



Y COMP and Mini Y COMP Muzzle Brake for "POST-BAN" Rifles...

These effective compensators for the 5.56mm/.223 AR type rifle are CNC machined from quality gun steel - with manganese phosphate final finish. They slip over the muzzle on Post-ban AR's and are held in place with a steel taper pin (drilling for the taper pin is required for installation). Angled ports on each side deflect gases, upper ports control muzzle rise. Y Comp adds 2 5/8" additional length to the Post-Ban barrel - Mini Y Comp adds 1 3/4".

Note: Bushmaster will only warranty factory installations of these muzzle brakes - no installation charge if purchased from Bushmaster.

Y COMP Muzzle Brake... \$48.95 (YHM-258P) or Mini-Y COMP Muzzle Brake... \$31.95 (YHM-259P)



Threaded Muzzle Brake / Flash Suppressor Adaptor for Bushmaster Carbon 15

Models... \$26.50 (AZ15133) Some Carbon 15 Rifles and Pistols have been manufactured with a unique Quick Detach Compensator that slips onto the specially machined muzzle, and locks in place by means of a spring loaded, ball detent collar. This Collar Adaptor allows the installation of standard flash suppressors and compensators on those Carbon 15 models by threading onto the collar, and installing on the muzzle in the usual manner. Machined from high quality steel and aluminum; matte black finished; threaded 1/2" x 28 T.P.I. pitch for standard .223 / 5.56 suppressors/compensators.

Note: If you intend to attach a suppressor or compensator which requires a particular position ("timing") for fully effective functioning, order a Crush Washer (# 12991533B - \$2.95) or a Peel Washer (# 9349052 - \$3.15) below.



Shoot-Away Muzzle Cap...

.45¢ ea. (RCL-10)

Red plastic muzzle cap designed to slip over AR15/M16 Barrels to keep out dirt and moisture. The thin plastic can be shot through safely if necessary.



Installation Washers... For correct "timing" of Muzzle Brakes; Flash Suppressors and Compensators

A2 "Crush" Washer... \$2.95 (12991533B)

Used at the Bushmaster factory for timing (positioning) suppressor and muzzle brake installations - for one time use only. It must be replaced after removal.



Gov't. Issue Type Blank Firing Adapter... \$15.95

(RAY-008) This device allows the AR15 type gas system to function with blank ammo. Made of heavy steel with a finish of bright red paint for safety. This assembly is designed to fit over the standard A2 birdcage flash suppressor.

WARNING! Remove this adapter BEFORE Firing Live Ammo!



A2 Peel Washer... \$3.15 (9349052)

A re-usable multi-layer washer for the correct timing of suppressor or brake installations on threaded muzzle barrels.

A1 Flash Hider Lock Washer... \$1.60¢ (8448577)



PISTOL GRIPS & BUTTSTOCKS...

A2 Standard Pistol Grip...

\$12.95 (9349127) Standard issue A2 hollow pistol grip of molded black plastic – with raised finger ridges, checkered panels and a ribbed backstrap.

Pistol Grip Screw & Washer...

Screw... .65¢ (AN501D416-18)

Washer... .45¢ (MS35335-61)



Pistol Grip Plug... \$4.50 (SCH-5)

Turns any standard A2 pistol grip into a "stowaway" grip for storage of small items. Molded of black rubber, snug friction fit holds it inside the grip cavity.

Hogue AR15/M16 Pistol Grip... \$31.95 (15000)

We use this comfortable, ambidextrous, textured rubber grip on our Varminter. Its an easy, one screw installation on your AR15/M16 (don't lose the safety detent or spring when changing over!). Hogue also offers companion free-floater forends (see Handguards section).



Pistol Grip only \$31.95 (15000)

Rifle Forend only \$79.95 (15002)

2 Piece Set... (Grip and Forend)

For Rifle \$106.95 (15003)

For Carbine \$106.95 (15013)

Carbine Forend only...

(Includes special gas tube) **\$79.95** (15004)

First Samco Tactical Stow Grip... \$25.95

(FBS-G27) Comfortable and ambidextrous, this "G27" type storage grip is molded from a synthetic material proven to minimize slippage when wet. Its extended beavertail and finger ridges provide excellent control - locking insert seals its internal storage compartment.



Forward Combat Grip... For AR rifles, this grip mounts beneath the front sight to offer solid control of muzzle rise in rapid fire. Use on any rifle or carbine with an unobstructed section of barrel for clamp-on attachment. **Specify if for Standard or Heavy AR Barrel...**

With A2 Standard Pistol Grip... \$20.95

Std. Barrel [.610" diam.]... (FWD GRIP-S)

Heavy Barrel [.720" diam.]... (FWD GRIP-H)

With Stowaway Grip... \$28.95

Std. Barrel [.610" diam.]... (FWD GRIP-WS-S)

Heavy Barrel [.720" diam.]... (FWD GRIP-WS-H)



The "Gapper"... \$3.95

(SCH4085) Fills that

blistery void between the pistol grip and the back of the trigger guard - molded of flexible black polyurethane. Fits snugly, or can be glued in place. Greatly increases grip comfort (shown at left separately, and installed).

See the Bushmaster Modular Accessories System Section of this Catalog for additional accessories.

ErgoGrip Tactical Deluxe Pistol Grip... \$42.00

(SCH4045) Universal to the AR15/M16 rifle platform, this is a heavier, ambidextrous grip that fills the hand well. It is



injection molded with an overmolded rubber Sure Grip™ textured finish, and offers a web support rear extension for improved control. It is virtually impervious to oils and solvents for great durability.

AR15/M16 Tactical Grip... \$63.95

(ARG01) The ultimate tactical grip for the AR15, this adjustable palm swell style grip adapts easily to different sized hands and puts pressure in the palm of the hand to allow a deliberate and calculated trigger pull. Molded of heavy black plastic, it installs easily on any AR15/M16.



Pachmayr "Vindicator" Grip... \$54.95

(04173) An ergonomically designed, hard rubber grip for the AR15 with a solid feel, fine checkering and finger grooves for excellent control and comfort - non-slip even when wet. Installs easily - requires a long 3/16" Allen Wrench (not included).



ErgoGrip Vertical

Forend... \$52.95 (ARG-FWD)

Mounts to all Picatinny rail and Weaver base type rails, this ergonomically designed forearm grip offers comfort and fire control. A hex nut through an aluminum mount block clamps the handle solidly onto the rail.



AR15/M16A2 Stowaway Grip... \$13.95

(56PT87SPG2) This M16A2 configuration grip - with a serrated backstrap and finger groove - features a trap door storage compartment for cleaning gear or small parts.



PISTOL GRIPS & BUTTSTOCKS

Six Position Fiberite Telescoping Stock Assembly...



\$106.95

(Part #1005-087-8988-PK)

Our standard issue tele-stock, this heavy duty design incorporates a six position latch assembly, and is made of the toughest materials available. Its ribbed body offers extra strength, as does the six position receiver extension machined from a solid aluminum extrusion. Its lower lip face acts as a timing edge to insure that the buffer retainer is held correctly and the extension is positioned in the correct location. An original design metal buffer with cylindrical weights (not plastic with BB shot) is included, and a sling loop is fitted in the standard position - alternately "top" slings can be attached through the slotted body.

Also available... **Complete Fixed Position Tele-Style Stock Assembly...** (1005-087-8988PEK) **\$106.95** This assembly includes the full length A2 Buffer Tube, Buffer and Spring.

The "Skeleton" Stock - this radically different stock design for all AR15 type rifles offers a comfortable neoprene foam sleeve and a skeleton frame that slides right on to the existing buffer tube of your rifle, then clamps tight with a new buttplate screw and the skeleton frame screws. A comfortable rubber buttplate is included, as well as a swiveling sling loop that can be mounted forward left, or right, or on the bottom of the buttplate. Length 10.5" / Weight 14.03 oz. (*This part number does not include buffer tube, buffer or spring - use already existing parts or buy the kit below).

Skeleton Stock Kit for Changeover from a Tele-stock... \$154.95 (SKELETON-STOCK-K) The Skeleton Stock is also available as a kit for those wishing to swap over from a telestock - includes Skeleton Stock with Buttplate and Hardware (as above) plus standard buffer tube, standard buffer and spring.



Replacement Foam Sleeves for Skeleton Stocks... For Standard Length model above. **\$4.50** (SKEL-FOAM-OT-8.2), or for the Shorty Skeleton Stock shown below... **\$3.95** (SKEL-FOAM-OT-5.5)

NOTE: These sleeves install easier with WD40.



Complete Bushmaster Lower Receiver with Skeleton Stock...

FFL Required for Purchase

M.S.R.P. \$415.00 (Part# A LOW SKELETON) See Page 15.



Original Style Fiberite

Tele-Stock Assembly...

\$106.95 (ALEO-001K) For those preferring the original style fiberite tele-stock body, we offer this assembly. It has the original four position telescoping aluminum extrusion extension tube, and includes an original design metal telescoping buffer with cylindrical weights, and the carbine length buffer spring. Always use a Telestock Assembly Wrench for tightening the extension tube onto your lower - available in our Gunsmithing Section.

AR15/M16 "Skeleton" Stock... \$112.95

(Part# SKELETON STOCK)*



Shorty Skeleton Stock Kit including CAR Buffer and Spring... \$148.95 (SKEL-SH-STK-KIT) Similar to the original Skeleton Stock above, but with an overall length of 7 3/4" - weight of 12.8 oz. The neoprene sleeve around the buffer tube offers a comfortable cheek weld. A 1/2" rubber recoil pad, a sling swivel (mounts either left or right side, or on buttplate base), a short Buffer Tube, a CAR Buffer and Spring, and all necessary screws are included to swap over from any AR type rifle or carbine.



For those who already own a CAR Buffer and Spring, the **Shorty Skeleton Stock** without those parts is... **\$134.95** (Part # SKEL-SH-STK).

Skeleton Stock Extended Recoil Pad... (SKEL-1IN-BUTTPAD) \$13.95 This extra thick, molded rubber Recoil Pad fits all the Skeleton Stocks including the Shorty Model. 1 inch in thickness, and 3.2 oz. in weight, for extra shooting comfort and extra trigger pull length. Installs easily in place of existing pad - screws are included.



PISTOL GRIPS & BUTTSTOCKS... Camouflage Finished Pistol Grip/Buttstock/Handguard Sets... These 3 Piece Sets - or individual parts - can now be added as accessory items to your rifle or carbine. High quality, tank dipped parts in either Desert Camo or RealTree® Camouflage Pattern - see color pictures on Page 3.

Bushmaster Stubby Stock... \$69.50 (9349119-S-KIT) with Carbine Buffer and Action Spring

This version of the standard A2 buttstock (3.25" shorter) makes the AR type rifle easy to carry in confined quarters - not much longer than a compressed telestock, but just long enough to be legal length with 16" barreled guns and sized well for women and younger shooters. Comes complete with carbine length Buffer and Spring. A standard rear sling loop is mounted, and the solid buttplate (no trapdoor storage compartment) is smooth and comfortable on the shoulder. Length 7.25 inches / Weight 14.6 oz.

Complete Bushmaster Lower with Stubby Stock... M.S.R.P. \$340.00 (A LOW STUBBY) An FFL is required for purchase - or see your FFL Dealer.

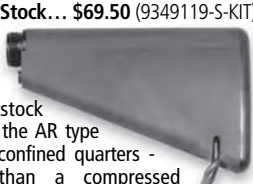

Complete A2 Trapdoor Buttstock Assembly... \$79.95 (A2 STK COMP)

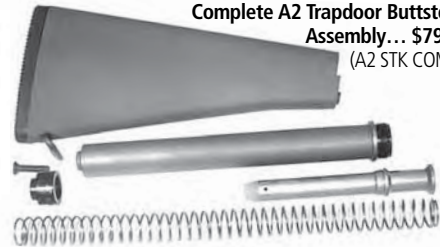

The newer A2 design is 5/8" longer than original A1 for greater shooting comfort and improved trigger pull length of 13.5". Trapdoor storage space in the buttstock provides room for spare parts or an Otis Buttstock Storage Cleaning Kit (see our Gunsmithing Section). Includes Buttstock w. Trapdoor Buttplate, Sling Loop, Buffer, Buffer Tube, Buffer Spring, Spacer and Vented Buttplate Screw.

Hook Style Buttstock for AR15/M16... \$44.95

(16-01-02) A molded fiberglass polymer stock offering the eye relief of the newer M16A2 type with 1" additional length of pull. The "hook" gives added stability to sandbag rest when shooting with left hand across the body and into the hook. Uses the standard issue buttplate but offers almost double the storage - easily replaces the standard stock.

Complete Hook Style Buttstock Assembly... \$95.50 (AR STK ASSY CHO) Includes Stock, Trapdoor Buttplate Assembly, Buffer, Buffer Tube, Buffer Spring, Spacer and Screw.



Delta Style Stock Cheekpiece \$74.50 (6200)

A quality accessory for your A2 buttstock - designed to improve accuracy by eliminating parallax problems. It shoulders easily and provides the proper cheek weld for telescopic sight use. Installs with no alteration to original butt cap or sling loop, and is designed specifically for the new style A2 stock (can be modified to fit the A1).



Command Arms Accessories "Saddle" for Bushmaster Telestocks... \$21.99 (FBS-SST1)

Get faster target acquisition - and stay on target - with this lightweight, ergonomically designed, cheekrest saddle. It fits new style Bushmaster Six Position Telestocks as well as those from many other manufacturers. Increases cheek support, and improves cheek and head stability while aiming and shooting to eliminate the typical head movement and fatigue associated with sighting-in targets for extended periods. Two tubular storage compartments for cleaning gear, small parts, or as many as six CR123 batteries, are molded in along the cheekrest sides, and sealed with waterproof O-ring plugs.



Assembly is easy with six allen head screws for a tight fit. Sling loops are incorporated into the mounting blocks for sling attachment on either side of the stock. Lifetime warranty by Command Arms Accessories.

Increases cheek support, and improves cheek and head stability while aiming and shooting to eliminate the typical head movement and fatigue associated with sighting-in targets for extended periods. Two tubular storage compartments for cleaning gear, small parts, or as many as six CR123 batteries, are molded in along the cheekrest sides, and sealed with waterproof O-ring plugs.

Bushmaster Modular Accessories System Stock... \$73.50 (YHM-9569) This design features a strong shoulder



See more information in B.M.A.S. Section

piece affixed to a tubular "body". It slips over your existing receiver extension tube and locks in place with the standard screw. The tubular section is rubber covered for non-slip shooting comfort, and seven holes are drilled and tapped for installation of a sling swivel stud.

Note: No Receiver Extension Tube is shipped with Part #YHM-9569. Use your existing extension tube.

B.M.A.S. Stock Kit with Receiver Extension... \$96.50 (YHM-9569K)



Magazines & Magazine Accessories... Bushmaster has reworked their magazines to offer significant improvements in function, durability and value. The aluminum box is stamped with a full "progressive" die to produce tightest tolerances. The welding process along the box seams has been automated to insure optimum weld ingot, strength and compliance with MIL-STD. The surface finish has been improved to meet or exceed MIL-PRF-46010 (required for U.S.G.I. magazines). Magazine boxes are treated with Molybdenum Disulphide ("Moly") for its exceptional adherence properties which ensure long lasting protection and lubricity - far superior to the PTFE (Teflon) used on other magazines. Finally, these magazines now have a new "anti-tilt" follower that ensures the round is fed into the chamber properly - preventing failure to feed problems. Drop tests have proven the advantages of the anti-tilt follower over the traditional green follower. As an additional aid, the followers are caliber marked - 5.56 in this case. Highest quality tempered steel springs, and Bushmaster logo stamped baseplates (removable for cleaning) round out the improvements on these superior magazines - which have been endorsed by the National Tactical Officers Association.



Bushmaster 30 Round Magazine... \$20.95 (8448670)

Bushmaster 20 Round Magazine... \$24.95 (8448670-20) Similar to the 30 Round, this 20 Round capacity aluminum magazine features a shorter, slightly curved body (this is not a straight body design). All features - box, follower, spring and baseplate are as described above.

Bushmaster Magazines for 6.8mm SPC...

These magazines for our new 6.8mm SPC Rifle and Upper are similar the 30 Rd. .223 magazine above, but due to larger 6.8 case size hold only 26 rounds. Other models are blocked to the indicated capacity within the same size dark grey hard anodized aluminum shell. They include anti-tilt followers, and the Bushmaster logo on the baseplate. All can be disassembled for cleaning.

26 Rd. 6.8mm SPC... \$35.95 (8448670-68)

10 Rd. 6.8mm SPC... \$35.95 (8448670-68-10)

5 Rd. 6.8mm SPC... \$35.95 (8448670-68-5)



NEW... Enhanced Magazine Rebuild Kit for 5.56mm/.223 Rem. 30 Rd. Magazines...

An enhanced, drop-in, Anti-Tilt Follower, and a Chrome Silicon Spring to bring your old magazines up to the latest USGI design. **Enhanced Magazine Rebuild Kit... \$11.95** (MAG205-Gray)

Bushmaster 10 Rd. Straight-Body Magazine...

\$20.95 (30-452) .223 Rem. / 5.56mm 10 Round capacity steel magazine with black finish and black follower. Works great in the M175 Bullpup, but can be used in all AR type rifles - and is accepted for High Power Match use by the Civilian Marksmanship Program and the N.R.A. Bushmaster ships these magazines with our DCM Competition Rifles - made in U.S.A.



40 Round Magazine for the AR15/M16... \$24.95 (MG-0007)

These are new .223/5.56mm Cal. 40 Round Magazines with a matte gray finished box and mil. spec. green follower. Due to local laws, we cannot ship these magazines to several States. Check your local regulations.



Magazines for Bushmaster Carbon 15 .22LR Rimfire Rifle & .22LR Rimfire Upper Assembly... \$24.95 (AZ15280)

These 10 Rd. Mags only fit the Bushmaster .22LR Rimfire Rifle and Upper Kit, and accept only .22 Long Rifle Caliber. A strong Carbon 15 Composite shell houses the metal magazine body, spring, and orange plastic cartridge follower - the shell can be disassembled for cleaning.



30 Round Magazines for Bushmaster 9mm Pistol & Carbine... Manufactured in either molded black polymer composite or metal (recommended for L.E. / heavy usage). Polymer Body is ribbed for a non-slip grip. Metal has indicator holes and quantity markings. Both can be disassembled for cleaning - both may hold 32 Rds., but for reliable feed, we recommend 30 Rds. max.



Black Polymer... \$28.95 (AZ9-00001)

Black Steel... \$59.95 (AZ9-00003)

NOTE: With the 2004 "Sunset" of the Federal Gun Legislation of 1994, many features of AR15 Type Rifle are again available - BUT **not** in all States! A number of States have their own Statutes regarding the legality of what they call "Assault Weapons" - and the High Capacity Magazines used in them. To avoid the possibility of legal problems, check your local Statutes (both State and County - they can differ!) before ordering the High Capacity Magazines (greater than 10 round capacity). If in doubt, consult the Bushmaster Sales Dept. (1 800 998 7928).

Magazines & Magazine Accessories...

Manufactured to latest U.S.G.I. standards, with improved box stamping, a superior weld strength along the seams, a surface finish improved to meet or exceed MIL-PRF-46010, and a Molybdenum Disulphide coating for long lasting protection and lubricity. These include the newest "anti-tilt" followers for superior feeding, and highest quality chrome silicon springs, and Bushmaster Logo stamped baseplates. Guaranteed for excellent fit and function in all .223/5.56mm AR15 type rifles.

Bushmaster 10 Round Magazine... \$20.95 (8448670-10)

Bushmaster 5 Round Magazine... \$20.95 (8448670-5) Similar to the 10 Round Magazine but blocked for hunting use (laws in many States limit magazine capacity to 5 rounds for hunting).

The MagPul... \$10.95 / Set of 3 (MP-3) A unique AR15/M16 magazine accessory developed from infantryman's ingenuity and the need to make fast magazine changes. GI's applied loops of duct tape or paracord to the bottom of the magazines to speed magazine interchange and to deaden the sound of mags in a storage pouch. This modern, molded black rubber MagPul improves upon the original concept with rough exterior texturing for positive grip, a semi-rigid finger loop for fast removal, and a snug fit on all AR type mags. Set of three.

Bushmaster Magazine Rebuild Kits... New Mil. Spec. parts to refresh your tired magazines - including New Spring, New Green Follower and Bushmaster Baseplate - use your own magazine bodies.

30 Rd. Mag. Rebuild Kit... \$6.50 (8448670-30K)

20 Rd. Mag. Rebuild Kit... \$6.50 (8448670-20K)

Green Magazine Followers... Original design, new, green plastic replacements for 5.56mm / .223 Rem. mags.
For 30 Round Magazines... \$1.95 (8448672)
For 20 Round Magazines... \$1.95 (8448672-20)



Bushmaster Magazine Springs...

Quality steel tempered for long memory / positive feed.

20 Round Magazine Spring... \$3.95 (8448671-20)

30 Round Magazine Spring... \$3.95 (8448671)



MagPul Ranger Floor Plate with Loop for 5.56mm Magazines...

(MAG020-BLK) **\$21.95 Set of 3**

This U.S. made floorplate assembly for 30 Rd. AR15/M16 Magazines incorporates an integral loop, floorplate lock, and mag identifier. When installed on the base of a magazine, the MagPul Ranger provides unsurpassed speed and controllability during high stress, tactical magazine changes. The loop is molded of pliable Santoprene over a stainless steel plate - a patented design based upon the tried and true para-cord loops and duct tape tabs used in special warfare units worldwide. Shown assembled and in pieces, instructions included. Can be modified to fit 20 Rd. magazines.



(Magazine not included)

MagPul Rubber Floor Plates for 5.56mm Magazines (MAG024-BLK) \$21.95

Set of 3... The MagPul L Plate is a replacement floorplate assembly for 30 Round AR15/M16 Magazines that incorporates a rubberized bumper pad of durable Santoprene overmolded onto a stainless steel plate. A durable hard plastic baseplate replaces the original magazine baseplate, then the bumper pad locks onto that and the tabs of the magazine body. Sold in sets of 3. Can be modified to fit 20 Rd. magazines. Instructions included. Made in U.S.A.



Magazine not included.

Bushmaster 5 & 10 Round Magazines...



(Magazine not included)

The EasyLoader... \$42.50 (8448670-EL223)

The EasyLoader - for Stripper Clips... \$42.50

(8448670-EL223SC) The EasyLoader works with a pull of the handle to loads all sizes of AR Magazines (other .223 cal. magazines as well). The larger model (8448670-EL223) is designed for loose ammo - just drop the rounds in, close the cover and pull the slide. The smaller model (8448670-EL223SC) handles ammo already loaded in Stripper Clips. Made in U.S.A.



Model for use with loose ammunition.

Model for use with Stripper Clips.

Magazines & Magazine Accessories...

Buttstock Mag Pouches for the AR15... Strap an extra magazine onto your rifle with these heavy duty pouches. Models available for either the full A2 Trapdoor Buttstock or the CAR Telescoping stock. Black nylon webbing construction with heavy metal snap closures offer durability, and velcro strap attachment systems make for easy installation and removal.

A2 Solid Buttstock Magazine Pouch... \$31.95 (TTMP)



Magazine Pouch for Telestocks... \$31.95 (TTTS)



AR15/M16 Magazine Gripper for 20 & 30 Rd. Magazines

\$23.50 (MG-01)

A heavy duty, black anodized aluminum dual clamp and screw kit designed to join either 20 or 30 round magazines. Offers the operator fast tactical reloads. Includes Allen wrench and instructions.

(Magazines not included.)



(Magazines not included)

Triple Magazine Connector...

\$26.95 (BC-100)

Clamp 3 - 30 Rd. Mags together in this black anodized aluminum mount for 90 rounds total capacity. Clamps solidly bolt together with Allen head screws.

Redi-Mag Model A1

\$79.95 (RM-15A1) with Bolt Release Button...

Carry your spare magazine and make quick swaps from an empty one to a full one. Just drop them out, move the fresh one over, and push the bolt release button to resume firing. Redi-Mag is constructed of sturdy steel and finished black to match your rifle.



Magazines not included

The "L.U.L.A." Mag Loader... \$25.50

(8448670-LULA) L.U.L.A. is a

"Loader/Un-Loader Accessory" that will load a 30 Rd. Mag in about 35 seconds, and unload it in 5!

They're very popular in the Bushmaster shooting room and are used by the Israeli

Military as well. Fits all

capacity 5.56mm/.223

AR15/M16 type magazines

including Thermolds and Orlites.



"L.U.L.A." Mag Loader for 9mm... \$31.95 (24218)

Similar in design and operation to model pictured above, but for 9mm stick magazines.

FN .308 Magazines... New 7.62mm

(.308) FN FAL mags - all steel construction.

.308 - 20 Rd. Mag. \$21.95 (MAT-004)

.308 - 10 Rd. Mag. \$33.95 (8448670-10-308)

.308 - 5 Rd. Mag. \$33.95 (8448670-5-308)

Steel FN Mag Loader... \$8.95 (MAT-001)



First Samco Magazine Coupler... \$12.95

(FBS-MCUP1) This plastic magazine

coupler firmly joins two 30 round

magazines. Molded of black

plastic with steel

clamping

screws.

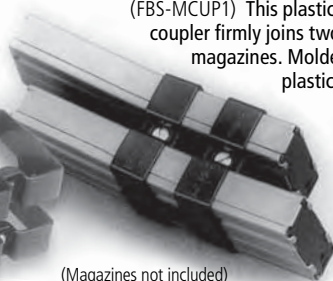

(Magazines not included)

AR15/M16 Magazine Connector...

\$25.50 (51-08-01) Hold twice the ammo

with this side by side magazine clamp - fits

both 20 and 30 round mags. When you empty

one magazine, drop them out, move over to

the full one, and quickly reinsert. Made of

heavy steel with flat black finish. Screw slot is

sized for use with a coin. Works with AR 180

magazines as well. (Magazines not included.)



Magazines & Magazine Accessories...

"ShotLock" Cable Lock for AR15 / M16...

\$8.50 (SLC3000) This keyed, 13" cable lock system will ensure safe storage of your rifle. It locks through the open ejection port and magazine well, and its vinyl covered cable prevents damage to finishes - useful on a variety of other rifles and pistols as well.



Stripper Clip Guides... (at left)

Stamped steel w. phosphate finish
\$1.00 ea. (EGSS-02)

Stripper Clip... (below)

.35¢ ea. (EGSS-01)

Stripper Clips... .30¢ each
in quantities of 25 or more.



Competition Shell Deflectors... \$22.95 ea. These shell case deflectors snap onto AR15 models to keep hot brass under control and away from other competitors on the firing line. Left handers who've experienced "hot brass in the face" will appreciate them. For the convenience of reloaders, they will drop all the cases in the same place at your feet, and are allowed under NRA High Power Competition Rules. Order by style & part numbers below. **A. For A2 Fixed Carry Handle... \$22.95** (BD-A2) / **B. For A3 Flat-tops... \$22.95** (BD-A3-flattop) / **C. For A3 Removable Handle... \$22.95** (BD-A3 Handle)

Bag Style Brass Catcher... \$42.50 (2693828) A flexible black Cordura nylon bag with an internal frame and a zippered opening on the underside for easy emptying of shell cases. A 2" wide velcro strap wraps around the

Fits V Match / Varminter / Predator



handguard to hold the bag and frame in place so that it fits flat-top and other AR15 type rifles.



Rigid Brass Catchers for AR-15 type Rifles... \$37.95 ea. These hard plastic brass catchers hold a minimum of

60 casings. Molded of black, nylon reinforced plastic, they snap on and off your rifle easily.

Order by Style & Part Numbers below...

For AR15/M16 A2 Fixed Handle Rifles...

(Part # EL-AR-001)

For AR15/M16 "Flat-top" Rifles without A3

Type Carry Handle... (Part # EL-AR-002)

For AR15/M16 A3 Removable Carry Handle...

(Part # EL-AR-003)

Universal Magazine Tool... \$6.50 (UMT) A pocket sized tool that will load or unload any magazine on the market today. Molded of heavy black plastic - includes a convenient brass key chain. Shipped with simple instructions for use.

AR15/M16 Magazine Dust Covers... \$7.50 (ATI15223) These flexible, molded black rubber caps snap over the the magazine top to keep out dust and water. Sold in Sets of Four - designed to fit standard AR15/M16 metal magazines (magazine not included).

AK47 Magazine Dust Covers... \$7.50 (ATI0762) Specially molded to fit AK magazines - similar to AR type shown. Sold in Sets of Four.



Three Magazine Pouch...

Sewn of Cordura nylon, with a silent clasp, suspension ring, and two belt clips (magazines not included).

\$16.95 ea.

Black... (6451)

Olive Drab... (6452)

Mag-Brush... Keeps your magazine well and mags clean - which will help keep your firing chamber clean.
For AR15, Mini 14 & 9mm UZI... \$6.50 (MAG206)
For .22; 10 mm; .38 Super... \$6.50 (MAG204)



SLINGS & BIPODS...

NEW from Bushmaster... SPEC-OPS Combat Slings

Spec-Ops Mamba Combat Sling for

Telestocked M4 & other Carbines

(100240101) \$39.95... The first sling designed for full contact engagement - for either left or right handed shooters, this quality USA made product offers fast and easy transitions with a "tensioned triangle" design to eliminate interference with body-mounted load bearing equipment. It's tubular web construction is super strong, and twist and tangle-free. Compatible with SOPMOD components, the Mamba's static-side "traverse" strap prevents the sling from tangling in weapons mounted sighting or lighting systems. The Mamba does not use any metal snap clips, velcro or other noise-making hardware.

Smarter - Stronger - Better!

100% Made in the USA

Mamba Combat Sling for Fixed Stock

Rifles (100240201) \$39.95...

Designed with a custom positioning "Speed-lok" feature, the Spec-Ops Mamba Slings allow the wearer to balance and position the weapon according to situational requirements. A unique stretch section built into the sling allows the user to strike an opponent with the weapon's muzzle ("barrel thump") while still keeping the weapon slung and in ready position. Adjusting buckles allow "pre-setting" the sling for operator's body size.

Guaranteed for Life!

The "Mamba" Power Strike Zone

Also available: The Spec-Ops Universal Mamba Sling (100240501) \$49.95... for ambidextrous mounting to either carbines or full stocked rifles - with all the Spec-Ops Mamba features described above.

And, The Master Blaster Combat Sling (100300101) \$29.95... Designed for combat shotguns and tactical rifles, this sling features two adjustments for quick transitions & body sizing, and quality tubular web construction.

Viking Tactical Slings... High

quality black 1" web slings that are fully adjustable while in use. Available in a Wide Padded model (upper photo) or Standard 1" web model, these can be used on either



Telestocked Carbine or with the Adapter (shown at far right),

on an A2 Solid Buttstock Rifle. Specify: Viking Tactical Padded Sling... \$40.95 (VTAC-MK2) or Viking Tactical Standard Web Sling... \$34.95 (VTAC-MK1) or Viking A2 Stock Connector... \$8.95 (VTAC-MK3)

Turner Saddlery AWS Competition Sling... \$74.50

(Part # TS-NMSRS) An extremely durable sling for DCM High Power Competition use with the AR15/M16 rifle - approved by CMP and NRA. Made of All Weather Synthetic (AWS) material which requires no break-in, and will not stretch. 54 - 56" with steel hooks. Stamped with the Bushmaster logo.



Padded Sling... For AR15/M16, or a variety of other rifles. Black webbing with a comfortable shoulder pad, and two black metal buckles. Specify 1" or 1 1/4" webbing width:

1 1/4" Wide Padded Sling...

\$13.95 (Part # AS-60)

1" Wide Padded Sling... \$13.95

(Part # AS-60-1)



Gov't. Issue Sling... \$5.50 (12624561) A

1 1/4" wide black nylon web sling - 54" long - with two black metal buckles.



SLINGS & BIPODS...

Quake Industries "Claw"
Non-Slip Sling... \$38.95 (51000-0)
A high quality 1" black webbing sling with a flexible, molded rubber shoulder pad that offers silence and comfort - won't slip or roll off your shoulder.



B.M.A.S. Rail Sling Mount... \$24.50 (YHM-94855)
Attach a sling to any accessory rail (Picatinny or Weaver type) with this B.M.A.S. Rail Sling Mount. Clamps onto rail system or forend, and locks down with one button head Allen screw. Includes a swivel sling mount stud.

See additional sling mounting accessories for the AR15 Type Rifle in the B.M.A.S. Section of this catalog.



Sling Mount Loops... For vertical carry mounting of various slings, the front loop mounts onto the sight assembly. For buttstock application, attach the loop onto the stock's rear sling loop. Phosphate finished - heavy spring steel wire.

Front & Rear Set - Two Loops... \$8.50 (2698877K)

or, Sold Individually... \$5.50 each (2698877)



Bushmaster Modular Accessory System Tactical Sling Adapter... \$14.95

(Part # 1005-914-2942-T) Made for attaching various types of tactical slings, it allows mounting either web type slings or those that have "lobster claw" type clips. This phosphate finished steel adapter plate replaces the receiver end plate of your telestock, and allows ambidextrous sling mounting on either the primary, or offside shoulder position for a comfortable "tactical" carry of the weapon. Removal of the stock and receiver extension is necessary for adapter installation.

Harris Ultralight Bipods... Versatile, sturdy, light, and fast - Harris Bipods are real quality. Folding legs have completely adjustable spring-return extensions. The sling swivel attaches to the clamp. Quality manufactured with heat treated steel and hard alloys - all black anodized finish. These bipods swivel 45° for instant leveling on uneven ground, and the hinged base has a tension adjustment and buffer springs to eliminate looseness. Leg Length: Extended - 13" / Retracted - 9". Harris Model L will mount directly onto Varminters & Predator. V Match rifles require installation of Sling Bipod Stud below right. Ribbed AR Handguards require the HE-001 adaptor below. For mounting to accessory rails, use the Samco FBS-BP1 (below) or our B.M.A.S. Aluminum Bipod Adapter (YHM-638) on Page 76.

Harris Model L - for XM15/AR15/M16 & others... \$118.95 (HE-002) [as shown]

Harris Bipod Adapter for AR15 Handguards... \$14.95 (HE-001)

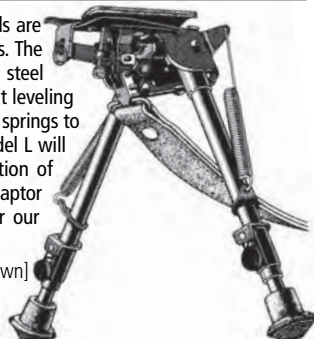

First Samco Equipment Mount for Rails...

\$31.99 (FBS-BP1) Mounts to any Picatinny or Weaver type rails with a button lock mechanism. Molded of high density black polymer with a standard stud for sling or bipod mounting.



Quick Detach Sling Swivels... \$12.95 / pair

(KNS-4) These 1 1/4" Loop Quick Detach Sling Swivels are heavy steel with a phosphate finish and a screw locking knob to ensure that the sling won't work loose from the rifle. Fits any firearms with standard sling swivel studs installed.



Steel Side-Sling Adapter... \$34.95 (Part # 12598617K) This adapter - the same as used in the original M203 grenade launcher kit - allows mounting a sling to the side of the barrel for easier ready position carry. Machined from gun steel, it is adaptable to both standard (.625" diam.) and heavy barrels (.750" diam.) by flipping the double concave lock plate when installing.

See the Bushmaster Modular Accessory System Section (B.M.A.S.) of this catalog for additional Bipod Studs and Mounting Adapters.



Bushmaster Sling/Bipod Stud... \$5.95 (B-0807)

This universal bipod mounting stud will mount any standard, Quick Detach type sling swivel. 3/8" shaft is threaded 10/32 - use a #21 drill bit before tapping. We use these on our Varminter models.



A2 Buttstock Sling Stud... \$14.95

(KNS-5) This phosphate finished steel stud replaces the old rear sling loop on standard A2 solid buttstocks. Unscrew the lower screw in the buttplate, then slip this in the loop cavity and replace the screw. Accepts any standard Quick Detach type sling swivel.



SLINGS & BIPODS...

NEW from Bushmaster... SPEC-OPS Combat Slings

Spec-Ops Mamba Combat Sling for

Telestocked M4 & other Carbines

(100240101) \$39.95... The first sling designed for full contact engagement - for either left or right handed shooters, this quality USA made product offers fast and easy transitions with a "tensioned triangle" design to eliminate interference with body-mounted load bearing equipment. It's tubular web construction is super strong, and twist and tangle-free. Compatible with SOPMOD components, the Mamba's static-side "traverse" strap prevents the sling from tangling in weapons mounted sighting or lighting systems. The Mamba does not use any metal snap clips, velcro or other noise-making hardware.

Smarter - Stronger - Better!

100% Made in the USA

Mamba Combat Sling for Fixed Stock

Rifles (100240201) \$39.95...

Designed with a custom positioning "Speed-lok" feature, the Spec-Ops Mamba Slings allow the wearer to balance and position the weapon according to situational requirements. A unique stretch section built into the sling allows the user to strike an opponent with the weapon's muzzle ("barrel thump") while still keeping the weapon slung and in ready position. Adjusting buckles allow "pre-setting" the sling for operator's body size.

Guaranteed for Life!

The "Mamba" Power Strike Zone

Also available: The Spec-Ops Universal Mamba Sling (100240501) \$49.95... for ambidextrous mounting to either carbines or full stocked rifles - with all the Spec-Ops Mamba features described above.

And, The Master Blaster Combat Sling (100300101) \$29.95... Designed for combat shotguns and tactical rifles, this sling features two adjustments for quick transitions & body sizing, and quality tubular web construction.

Viking Tactical Slings... High

quality black 1" web slings that are fully adjustable while in use. Available in a Wide Padded model (upper photo) or Standard 1" web model, these can be used on either



Telestocked Carbine or with the Adapter (shown at far right),

on an A2 Solid Buttstock Rifle. Specify: Viking Tactical Padded Sling... \$40.95 (VTAC-MK2) or Viking Tactical Standard Web Sling... \$34.95 (VTAC-MK1) or Viking A2 Stock Connector... \$8.95 (VTAC-MK3)

Turner Saddlery AWS Competition Sling... \$74.50

(Part # TS-NMSRS) An extremely durable sling for DCM High Power Competition use with the AR15/M16 rifle - approved by CMP and NRA. Made of All Weather Synthetic (AWS) material which requires no break-in, and will not stretch. 54 - 56" with steel hooks. Stamped with the Bushmaster logo.



Padded Sling... For AR15/M16, or a variety of other rifles. Black webbing with a comfortable shoulder pad, and two black metal buckles. Specify 1" or 1 1/4" webbing width:

1 1/4" Wide Padded Sling...

\$13.95 (Part # AS-60)

1" Wide Padded Sling... \$13.95

(Part # AS-60-1)



Gov't. Issue Sling... \$5.50 (12624561) A

1 1/4" wide black nylon web sling - 54" long - with two black metal buckles.



SLINGS & BIPODS...

Quake Industries "Claw"
Non-Slip Sling... \$38.95 (51000-0)
A high quality 1" black webbing sling with a flexible, molded rubber shoulder pad that offers silence and comfort - won't slip or roll off your shoulder.



B.M.A.S. Rail Sling Mount... \$24.50 (YHM-94855)
Attach a sling to any accessory rail (Picatinny or Weaver type) with this B.M.A.S. Rail Sling Mount. Clamps onto rail system or forend, and locks down with one button head Allen screw. Includes a swivel sling mount stud.
See additional sling mounting accessories for the AR15 Type Rifle in the B.M.A.S. Section of this catalog.



Sling Mount Loops... For vertical carry mounting of various slings, the front loop mounts onto the sight assembly. For buttstock application, attach the loop onto the stock's rear sling loop. Phosphate finished - heavy spring steel wire.



Front & Rear Set - Two Loops... \$8.50 (2698877K)
or, Sold Individually... \$5.50 each (2698877)



Bushmaster Modular Accessory System Tactical Sling Adapter... \$14.95
(Part # 1005-914-2942-T) Made for attaching various types of tactical slings, it allows mounting either web type slings or those that have "lobster claw" type clips. This phosphate finished steel adapter plate replaces the receiver end plate of your telestock, and allows ambidextrous sling mounting on either the primary, or offside shoulder position for a comfortable "tactical" carry of the weapon. Removal of the stock and receiver extension is necessary for adapter installation.

Harris Ultralight Bipods... Versatile, sturdy, light, and fast - Harris Bipods are real quality. Folding legs have completely adjustable spring-return extensions. The sling swivel attaches to the clamp. Quality manufactured with heat treated steel and hard alloys - all black anodized finish. These bipods swivel 45° for instant leveling on uneven ground, and the hinged base has a tension adjustment and buffer springs to eliminate looseness. Leg Length: Extended - 13" / Retracted - 9". Harris Model L will mount directly onto Varminters & Predator. V Match rifles require installation of Sling Bipod Stud below right. Ribbed AR Handguards require the HE-001 adaptor below. For mounting to accessory rails, use the Samco FBS-BP1 (below) or our B.M.A.S. Aluminum Bipod Adapter (YHM-638) on Page 76.



Harris Model L - for XM15/AR15/M16 & others... \$118.95 (HE-002) [as shown]
Harris Bipod Adapter for AR15 Handguards... \$14.95 (HE-001)

First Samco Equipment Mount for Rails...

\$31.99 (FBS-BP1) Mounts to any Picatinny or Weaver type rails with a button lock mechanism. Molded of high density black polymer with a standard stud for sling or bipod mounting.



Quick Detach Sling Swivels... \$12.95 / pair

(KNS-4) These 1 1/4" Loop Quick Detach Sling Swivels are heavy steel with a phosphate finish and a screw locking knob to ensure that the sling won't work loose from the rifle. Fits any firearms with standard sling swivel studs installed.



Bushmaster Sling/Bipod Stud... \$5.95 (B-0807)

This universal bipod mounting stud will mount any standard, Quick Detach type sling swivel. 3/8" shaft is threaded 10/32 - use a #21 drill bit before tapping. We use these on our Varminter models.



A2 Buttstock Sling Stud... \$14.95

(KNS-5) This phosphate finished steel stud replaces the old rear sling loop on standard A2 solid buttstocks. Unscrew the lower screw in the buttplate, then slip this in the loop cavity and replace the screw. Accepts any standard Quick Detach type sling swivel.



Steel Side-Sling Adapter... \$34.95 (Part # 12598617K) This adapter - the same as used in the original M203 grenade launcher kit - allows mounting a sling to the side of the barrel for easier ready position carry. Machined from gun steel, it is adaptable to both standard (.625" diam.) and heavy barrels (.750" diam.) by flipping the double concave lock plate when installing.



See the Bushmaster Modular Accessory System Section (B.M.A.S.) of this catalog for additional Bipod Studs and Mounting Adapters.

BUSHMASTER GUNSMITHING...

Remember, Bushmaster offers Free Gunsmithing and Assembly on most Parts & Accessories when those parts are purchased from us — another Bushmaster value making us — The Best... By a Long Shot!

See Pages 40/41 for a complete Bushmaster XM15 Disassembly Schematic Diagram / Parts Reference

Our company policy is to offer Gunsmithing Assembly at No Charge when parts are purchased from us (with the exception of sight bases). We will also offer our professional gunsmithing services to any customers who care to ship us their AR15 Type firearms or assemblies for repair or buildup - and we will work on brands other than Bushmaster. Gunsmithing time is charged at \$40.00 per hour, and we charge a flat \$16.50 fee for return shipping of your rifle, upper or parts. For an estimate on your gunsmithing needs, call 1-800-998-7928 during business hours, or E-mail a complete description of your needs to: Techsupport@bushmaster.com

BUSHMASTER STANDARD ARMORER'S TOOL KIT... \$85.95 (Part #s A1 ARM KIT / A2 ARM KIT) A standard selection of indispensable tools for all AR15 assembly, disassembly and maintenance procedures (choose from A1 or A2 version - tools included differ). Kit includes: Dual Slot Barrel Vise Jaw Blocks; Drift Punches; Barrel Wrench; Receiver Push Pin Tool; Technical Service Manual; Sight Tool; Cleaning Kit; Spring Package w/Standard Buffer Spring; and Assorted Pins and Caps.

DELUXE ARMORER'S TOOL KIT... \$180.95 (Part #s A1 DARM KIT / A2 DARM KIT) A complete tool kit for all necessary repairs and installations (choose from A1 or A2 version - tools differ). Kit includes: Dual Slot Barrel Vise Jaw Blocks; Drift Punches; Armorer's Barrel Wrench; 200 Page Technical Manual; Sight Tool; Cleaning Kit; Tele-Stock Wrench; Go; No-Go and Field Headspace Gauges; Firing Pin Protrusion Gauge; Receiver Push Pin Tool; Spring Package with Standard Buffer Spring; and Assorted Pins and Caps.

MASTER ARMORER'S TOOL KIT... \$319.95 (Part #s A MARM KIT) Total AR assembly and disassembly tools for the professional! Includes: Armorer's Action Block Kit; Lower Receiver Vise Block; Heavy Duty Combination Armorer's Wrench; Barrel Vise Jaw Blocks; Drift Punch Set; Rifle Cleaning Kit; .223 Go/No-Go/Field Headspace Gauges; Firing Pin Protrusion Gauge; A1 and A2 Sight Tools; Receiver Push Pin Tool; 200 page M16 A2 Marine Corp. Technical Manual; M16 A1 Technical Manual; Armorer's Video; Tetra Gun Care Kit; 2 complete spring packages (with carbine & rifle buffer springs), and an assortment of pins, detents and caps for fast and foolproof assemblies and installations. A great value - cost of components purchased separately would exceed \$325!

Receiver Push Pin Tool... \$7.50 (IMP-1)  This handy tool is designed to push out tough Takedown and Pivot Pins in your lower receiver. Machined from black nylon material so it won't mar the gun's finish, it also helps install the small Pivot Pin Detent and Spring, and will fit into the buttstock storage compartment.

Barrel Vise Jaw Blocks... \$15.95 (AMER-001) A dual slot design for the installation of barrels, front sight removal rear sight work, cleaning, or any job that requires immobilization of the rifle - just insert them into your vise. These heavy aluminum blocks are not limited to AR15/M16 service work - they make an excellent all around gunsmithing tool, and they will not mar the finish of the rifle or barrel. 

Headspace Gauges... High quality machined steel gauges for Bushmaster 5.56mm Caliber Rifles and Carbines - including instructions for use. Also available, a headspace gauge set for all .308 Caliber Rifles... (Part #s below).

5.56mm NATO Caliber Go-Gauge... \$30.00 (HGO223G) Used to determine adequate headspace. Chamber depth enough or oversized bolt.

5.56mm NATO Caliber No-Go Gauge... \$30.00 (HGO223N) Used to determine excess headspace. Chamber depth too great, or undersized bolt.

5.56mm NATO Caliber Field Gauge... \$30.00 (HGO223F) Used to determine overly excessive headspace due to chamber and bolt wear.

.308 Cal. Go-Gauge... \$30.00 (HGO243G)

.308 Cal. No-Go Gauge... \$30.00 (HGO243N)

.308 Cal. Field Gauge... \$30.00 (HGO243F)

Drift Punch Set... \$22.95 (STA PNCHSET) A Set of Four excellent Starret Punches - 1/16", 3/32", 1/8", 5/32" - all the necessary sizes for any work on the AR15/M16 rifle, as well as many other mechanical projects. 

U. S. Gov't. Tech Manuals... Complete Maintenance, Repair and Troubleshooting Information for either the A1 or A2 model (A2 shown here). Approx. 300 fully illustrated pages - 8 1/2" x 11".

For M16A2... \$11.95
(Part # TM9-1005-319-23P)

For M16A1... \$11.95
(Part # TM9-1005-249-24P)



BUSHMASTER GUNSMITHING...

The Bushmaster DVD...

\$25.95 (ADS-002) Complete assembly and build up details for the XM15/AR15/M16 rifle. This live, 60 minute, digitally photographed DVD will help you understand the complete Bushmaster system in extensive step by step detail. Our Armorer describes the tools needed for every operation, shows the details of all subassemblies, and demonstrates function checks - all in sharp, digital close-ups. A brief history of the rifle's development is included, along with an overview of the wide variety of customizing parts and accessories available. Safety rules, and armorer's assembly tips from our 40 years of knowledge and experience with the AR15 rifle system will walk you safely through any maintenance or repair work.

Also available... The Bushmaster Video...

\$21.95 (ADS-001) All the live video instruction and rifle assembly information of the DVD above but in standard VHS Videocassette format - 60 minutes.

Field Bolt Carrier Carbon Scraper... \$20.95 (BC01) This tool steel scraper quickly removes carbon buildup in all AR15/M16 bolt carriers. Just slide a section of cleaning rod into the hole in the end, insert in your carrier, and twist. And, it is small enough to fit into the buttstock storage compartment.

Firing Pin Protrusion Gauge...\$15.95 (MMT-0005) Checks firing pins for minimum (.028") and maximum (.036") protrusion. Excess pin protrusion can pierce the primer - causing the rifle to blow up. Insufficient protrusion results in rifle's failure to fire. Use this gauge to measure pin protrusion on AR15/M16 rifles or any center fire rifle.

AR-15 Combination Armorer's Wrench for Newer TeleStocks... \$23.50 (1570-4) A newer design Armorer's Wrench that fits the latest model telestocks with the cuts on the locking ring, this heavy duty tool combines many necessary functions for the AR15/M16 armorer, and features rugged steel construction with a "hammered" black/grey finish - 1.125 lbs - 12.25" overall. A two sided wrench at one end fits either multi-point or peg style barrel nuts on barrels up to 1" in diameter. A breaker bar or torque wrench can fitted into the 1/2" square drive opening. Two other slots fit A1 and A2 birdcage flash suppressors and receiver extensions.

Weight: 1.125 lbs. / Length: 12.25"

Heavy Duty Combination AR-15 Armorer's Wrench... \$22.50 (1570) This tool combines many of the functions necessary for the AR15 / M16 Armorer. A two sided wrench at one end fits either multi-point or peg style barrel nuts on barrels up to 1" in diameter, and a breaker bar or torque wrench can fitted into the 1/2" square drive opening. The wrench's other end fits Telestock Locking Nuts, and a large flat screwdriver blade is also included for use on standard buttstock screws. Two other slots fit A1 and A2 birdcage flash hiders and receiver extensions. Heavy steel construction with a black/grey "hammered" paint finish.

Weight: 1.25 lbs. / Length: 13"

Armorer's Barrel Wrench... \$11.95 (RM-001) For AR15/M16 barrel removal and installation - original Gov't. issue tool in oiled paper wrap with 1/2" square drive opening for a torque wrench or breaker bar - also fittings for flash suppressor and receiver extension.

Note: Will not fit our DCM profile barrels.

TeleStock Wrench for new style (ribbed) TeleStocks... \$6.50 (223-telewrench2) An economical tool for the locking nuts on newer type telestocks (fixed and collapsible) - three lugs accurately engage the indents on the lock nut, and an additional hole fits the end of the receiver extension tube for disassembly work. Stamped steel construction with vinyl coated handle.

Bushmaster Operating & Safety Manual... \$2.95

(BFIMANA20P) 64 Pages Field Stripping; Cleaning, Maintenance on all Bushmaster XM15 and Carbon 15 Models - with Parts Diagrams, Safety Tips and Sight Zeroing.



AR15/M16 Gas Tube Wrench...

\$31.95 (MBC-01)

This tool eases the installation or removal of the rifle's gas tube. 5 1/4" long with black plastic handle.

Also fits works on AR10 / SR25 rifles.

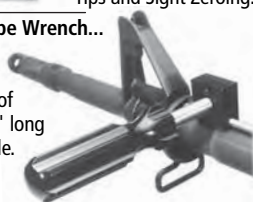

Bolt Carrier Carbon Scraper... \$31.95 (MBC-02)

A sturdy workbench tool for the AR15/M16 gunsmith. Makes quick work of cleaning out carbon buildup inside the Bolt Carrier - a few quick twists of the wrist can have your Bolt Carrier cleaned out and in perfect operating condition.



BUSHMASTER GUNSMITHING...

Lower Receiver Vise Block... (Part # OM-006)
\$31.95 Clamp it in a vise, and it's magazine shape locks into the magazine well of any AR15-XM15-M16 lower receiver for assembly or maintenance work. Machined from high density polyethylene. Use in either normal or inverted positions - will not distort receiver or harm the finish.

(Vise and Receiver shown are not included.)

Also available, a larger version for the Bushmaster .308... \$39.95 (OM-007)



Sight Adjustment Tools... Adjustment tools for A1 & A2 Front Sights, and A1 Rear Sight. Machined steel with black oxide finish - designed to fit in the stow-grip or buttstock compartment.

For A1 Rifles... (Round Sight Post) **\$8.50 (RAY-006)**

For A2 Rifles... (Square Sight Post) **\$8.50 (RAY-005)**

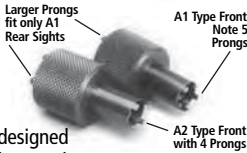

Gunslick® Ultra Gun Care Cleaning Kits...

Multi Caliber Cleaning Kits with highest quality components.



Phosphor Bronze Brush; Wool Mop; Cotton Patches; Cleaning Tip and Jag; and a Muzzle Guard - All packaged in a sturdy blue plastic, storage box - everything you need for complete firearms care.

Safety Block for AR-15/M16 Rifles and others...

\$2.50 (Part # SBBF1) Molded orange plastic with Bushmaster name. Cone end inserts into the firing chamber - handle protrudes to indicate a safe firearm condition.



Bushmaster Armorer's Action Clamp for all AR15/M16 type rifles... \$41.50 (OM-003) This Action Clamp works with all models of AR type rifles (even early A1's), including the popular A3 "flat-top" Upper Receiver - even when the Carry Handle is in place. Used in conjunction with an Armorer's Barrel Wrench (available from our Catalog or Website), it eliminates barrel vise jaw blocks for removing or replacing barrel assemblies, and is necessary when installing tubular aluminum V Match handguards or competition free-floating tubes.

(Upper receiver is not included)



Also available for Bushmaster .308... \$53.95 (OM-004)

AR15 Multi-Tool... \$12.95 (BT-MCT) This handy tool packs several "AR" related functions into a compact package lighter than 2 rounds of ammo. The Multi-Tool will (1) adjust front sights; (2) clean bolt faces (removes residue and powder fouling) and it includes (3) a disassembly punch (large one for the take down pin, the smaller for lower receiver pins - neither will mar the finish of your rifle); (4) a tool useful as a Phillips screwdriver or a scraper; and (5) a Lanyard loop to tie it to your web gear or tool bag. The high carbon stainless steel insert is heat treated to

Rockwell 48-50 for long life.

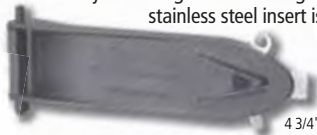

4 3/4" Overall Length

Gunslick® .22 / .223 Cal. Cleaning Kit... \$15.95 (62008-223) or Gunslick® .308 Cal. Cleaning Kit... \$15.95 (62014-308)

These quality kits are offered in either .22 Caliber or .30 - .32 Caliber versions. The .22 Caliber kit is a great value for all Bushmaster .223 Rem / 5.56mm rifles or pistols, and the .30 - .32 Caliber model will keep your Bushmaster .308 - or any other .30 Cal. rifle clean and ready for the range. Gunslick® Kits contain: 2.25 oz. of Ultra-Lube

Advanced Gun Oil; 2 oz. of Ultra-Klenz Advanced Gun Cleaner; a quality,

3-piece Cleaning Rod of blackened steel with overmolded "soft grip" T-Handle;

AR15/M16 Lower Receiver Safety Block... \$7.50 (SB16) This bright yellow safety block locks into the magazine well when the bolt is retracted and indicates a safe weapon. We use them regularly here at the Bushmaster factory!



Dewey Coated Rods... Top quality rods featuring one-piece construction with an unbreakable ball bearing handle. 8-32 female threaded to accept standard brushes or other manufacturer's accessories. Includes a universal style brass patch loop. The rod's nylon coating protects rifling and preserves the barrel's accuracy.

Dewey 22CF-24" - for barrels to 20" - \$27.95 (Part# DEWEY-100)

Dewey 22CF-30" - for barrels to 24" - \$27.95 (Part# DEWEY-200)

Dewey 22CM-36"* - 8-32 male threaded w. adapter - \$28.95 (Part# DEWEY-22CM-36)

*Use Dewey 22CM-36" with a Breech Rod Guide in barrels 24" or longer.

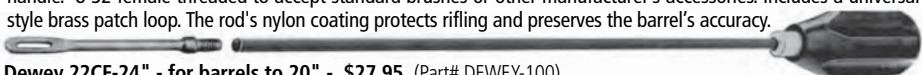

BUSHMASTER GUNSMITHING...

(DEWEY-30C-36) A 36" long, one piece, .30 Caliber, nylon coated rod - comes with a jag and brush adapter (12/28 male thread). A thick coating on the rod protects the bore from scratches and its ball bearing handle allows the rod to spin as it follows the rifling - ideal for the Bushmaster .308 - or any other .30 caliber barrel.

Dewey Delrin Cleaning Rod Guides... Maintain the original accuracy of your rifle by protecting the all important muzzle of the barrel - use these guides with all types of cleaning rods. Dewey Delrin Guides direct your cleaning rod straight into the barrel and prevent it from contacting the muzzle - some models have brass inserts to guard against rod wear.

Models for: AR15/M16 Postban... (.700" diam. at muzzle)
\$9.95 (DEWEY-1100)

AR15/M16 PreBan... **\$7.95 (DEWEY-300)**

M1 Garand... **\$7.95 (DEWEY-400)**

M14 & M1A... **\$7.95 (DEWEY-500)**

Mini 14... **\$7.95 (DEWEY-600)**

Mini 30... **\$7.95 (DEWEY-700)** Also fits Bullpup

Ruger 10-22... **\$7.95 (DEWEY-800)**

Dewey AR15/M16 Breech Rod Guide...

\$23.95 (DEWEY-1000) For all M-16s and AR-15s. Guides cleaning rod straight into the barrel from breech end. An O-Ring seal prevents oil and debris from coming back into the action (spare O-Rings and ring installation tool included). For barrels 24" and longer, we recommend using a 36" rod with this rod guide (see Dewey Rod Dewey-22CM-36 above).



Dewey .308 Breech Rod Guide... \$25.95

(Dewey-AR-10) This guide replaces the bolt carrier in your Bushmaster .308 Rifle/Carbine and ensures that the cleaning rod will go straight into the bore without harming the chamber or throat. O-Rings seal off the chamber to prevent any back-flow of cleaning solvents and debris into the action, trigger and magazine areas. Spare O-Rings and a cone shaped aluminum tool for their installation are included. Rod guide construction is aluminum and black delrin plastic.



Otis Technology Gun Cleaning CD...

\$5.95 (2001) All the tips, techniques and information needed to keep any rifle, pistol, shotgun or blackpowder piece in perfectly functioning, spotless condition - compiled in a handy MiniDisc CD format. A full color printed brochure with highlights from the CD is included - both are packaged in a ziplock bag - "The Industry Guide to the Proper Care and Cleaning of Firearms"

Dewey Cleaning Rod Adaptor... \$3.25

(DEWEY-22-M-ADPT) A machined brass adaptor threaded (female 8-36 / male 8-32) to accept the military type cleaning brushes - allowing them to be used with Dewey and other commercial cleaning rods.



Otis Buttstock Storage Cleaning Kit... \$46.95

(224-2)

A 16 pc. cleaning kit for the AR15/M16 packed in a wedge shaped Cordura pouch shaped to fit inside the rifle's buttstock storage compartment - lifetime

guaranteed by Otis Technology. Includes Bore and Chamber Brushes, Memory-Flex Rod, Double End Brush, Slotted Patch Tip, Patches, NATO Adapter, Bore Light, Chamber Rod, T-Handle, CLP Solvent, and more.



Otis Tactical Cleaning System...

\$47.95 (750)



This premier 23 component weapons cleaning system cleans all rifles .177 to 50 caliber, shotguns .410 to 10 gauge, and pistols .177 to 45 caliber. It is packed into a zippered, round, black nylon soft-pak that measures only 4" diam. by 2" thick, and includes 5 brass bore brushes; 3 forged brass tips; 3 memory-flex rods; a t-handle; a shotgun adapter; all caliber patches and patch savers; 1/2 oz. bottle of bore solvent; a NATO adaptor for military brushes and a bore reflector/safety flag. A cleaning manual is included as well. Weighs approx. 9.3 oz.

BUSHMASTER GUNSMITHING...

Gov't. Issue M16 Cleaning Kit... \$10.50 (Part # A CLEAN) This complete kit includes a T-Handle; a 4 piece rod; swab holder; bore and chamber brushes. Will fit in the standard buttstock compartment of the AR15, XM15 or M16 rifle. All threading is the military 8-36.



TetraGun ProSmith™ Cleaning Rods...

These sturdy 3/16" diameter rods will fit the bore of everything from .22 rimfire and .223 on up to big bore magnums. Made from #416 heat-treated stainless steel, and Corvel M coated for maximum barrel protection, ProSmith™ rifle cleaning rods are equipped with a free-spinning Delrin handle with screw-on bushing and brass collar. These rifle rods may be used with most commonly available 8-32 thread brushes, jags and other cleaning tools. Order the Dewey adaptor above to use military (8-36) threaded brushes. Specify rod length:

TetraGun ProSmith™ Cleaning Rod 29" Length... \$26.95 (920-C)

TetraGun ProSmith™ Cleaning Rod 36" Length... \$27.95 (925-C)



AR15/M16 Handguard Removal Tool... \$21.95



(Part # HGD-Tool) This handy tool provides the leverage needed to compress the weld spring inside the delta ring, and eliminates the need for a second person to help remove AR15/M16 handguards. We use this tool frequently at the Bushmaster plant - manufactured from strong, powder coated, 1/4" round steel stock with protective vinyl coatings in all critical contact areas. Works equally well on both straight and tapered delta rings.

BIRCHWOOD CASEY

BIRCHWOOD CASEY HIGH QUALITY GUN REFINISHING PRODUCTS...

Birchwood Casey Super Black Touch-Up Pens... \$6.95 ea. Touch-up nicks, and scratches on black anodized aluminum, polished and matte finished alloy gun receivers, trigger guards, scopes or black painted surfaces - a fast drying, lead-free paint with superior adhesion and durability for gunsmithing uses. The felt tip chisel point touch-up pen holds 1/3 fl. oz.

For Gloss Black Finish... \$6.95 (Gloss - 15101) / **or For Flat Black Finish... \$6.95** (15102)

Birchwood Casey Aluminum Black Metal Finish... (15125) \$8.50 3 fl. oz. This room temperature chemical is used by gunsmiths and the metal industry to blacken aluminum parts and to restore scratched or marred areas quickly. A fast acting liquid, it's easy to apply, and makes no dimensional changes to the part. Final color will vary from deep gray to black depending on the alloy of the aluminum part it is applied to.

5.56mm / .223 Rem. Caliber Bore & Chamber Brushes... High quality tools for barrel cleaning...

• **Chamber Brush... \$2.00** (BR-001)

Military 8-36 Threading



• **Bore Brush... \$1.65** (A190)

KleenBore Bore Brushes... \$1.65 ea. Top quality - all threaded 8-32 for commercially available rods.

• **6.8mm / .270 Caliber Bore Brush... (Part # A-179)**

• **7.62mm / .30 Caliber Bore Brush... (Part # A-180)**

• **9mm / .38 Caliber Bore Brush... (Part # A-181)**

• **4mm / .45 Caliber Bore Brush... (Part # A-182)**

Cleaning Kit Case... \$8.95 ea. New Gov't. Issue nylon cases with snaps and velcro closures.

Available in...

Black

(PO303B),

or

Olive Drab

(PO3030D)



Cleaning Kit COMBO...

The 7 Piece Gov't. Issue Cleaning Kit shown above packed in the nylon Cleaning Case Kit. Specify Black or Olive Drab Case...

Cleaning Kit in Black Case... \$16.95 (cleankitB)

Cleaning Kit in Olive Drab Case... \$16.95 (cleankitOD)

The Bushmaster Gun Pad... \$9.95 (QP-014) It's a sturdy counter-top protector for gunsmithing assembly work and it doubles as a computer mouse pad. This big (18" x 12") brightly colored pad has crisp images representing the Bushmaster family of rifles and pistols. It's surface is laminated and the backing is soft, non-skid foam padding.

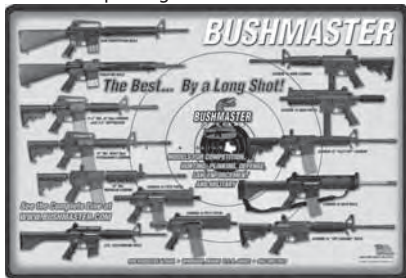

BUSHMASTER GUNSMITHING...

The Tetra Gun Cleaning Pack... \$23.50 (5337100802)

A superior firearms maintenance and preservation system based on a revolutionary breakthrough in synthetic polymer technology that will fight corrosion - reduce friction - reduce wear - improve performance - and make gun cleaning easier. **Tetra's Gun Cleaning Pack Contains...**

- **1 oz. Tetra Gun Lubricant:** A synthetic, polymer based lubricant and conditioner for action and all moving parts.
- **1 oz. Tetra Gun Grease:** Synthetic polymer based white grease for use on all metal to metal contact surfaces.
- **3.75 oz. Tetra Gun Spray:** Synthetic polymer based cleaner and light lubricant - removes dirt, combustion residue, old lubricants and solvents, and offers corrosion protection.
- **4 oz. Tetra Copper Solvent:** Concentrated copper, lead, powder, and plastic remover. Removes stubborn fouling from barrels and provides fast, effective cleaning without "barrel etching".



Tetra Field Kit... \$7.95 (TETRAFIELDKIT) All the necessities to keep your gun functioning on the range or in the field. Includes: 1 oz. tube Tetra Gun Grease and 1 oz. plastic bottle Tetra Gun Oil.

Tetra Gunsmith's Kit... \$31.95 (TETRAKIT) Professional quantities of high quality Tetra products: 2 - 1 oz. tubes of Tetra Gun Grease / 8 oz. Tetra Gun Oil / 8 oz. Tetra Gun Spray.

Tetra Gun Blue & Rust Remover... \$5.50 (5337100001) 3 fl. oz. Removes old bluing and rust quickly and effectively without damage to base metal - a necessity before re-bluing or browning.

Tetra Gun Liquid Gun Blue... \$5.50 (5337100002) 2.7 fl. oz. A great product for touch-up or complete re-bluing of firearms. This fast-acting cold liquid yields a non-streaky, uniform blue-black finish to steel (**won't work on stainless steel, aluminum or nonferrous metals**).



Tetra Gun Copper Solvent... \$8.50 (5337100501)

Removes stubborn fouling without "barrel etching". All-in-one copper, lead, powder and plastic remover in concentrated liquid form. 4 fl. oz. bottle.



Cleaning Patches... \$5.50 (Part # 923) Bag of 100... Sized for the AR15/M16 rifle bore, 100 soft white cotton flannel cleaning patches - a necessity for all firearms maintenance!

Individual Tetra Products...

Tetra Gun Grease...

1 oz. Tube \$5.50 (5337100005)

Tetra Gun Oil...

1 oz. \$4.50 (5337100006)

4 oz. \$7.95 (5337100303)

8 oz. \$12.95 (5337100304)

Tetra Gun Spray Cleaner...

3.75 oz. \$7.50 (5337100201)

8 oz. \$11.95 (5337100202)



Firepower FP-10 "CLP" Type Lubricant... A Cleaner, Lubricant, and Preservative for Weapons & Weapons Systems, Firepower FP-10 is a semi-synthetic CLP specifically formulated for the serious Shooter, Soldier, Law Enforcement Officer, Sportsman and Professional Armorer. It's extraordinary abilities to clean, remove lead, lubricate, guard against extreme pressure and wear, and protect from corrosion - all in one product - make it the ultimate for the total care of all firearms, and other sporting goods.

1 oz. Bottle...

\$4.25 (FP-10-1)

4 oz. Bottle...

\$6.50 (FP-10-4)

16 oz. Bottle...

\$14.95 (FP-10-16)



BUSHMASTER A1 SIGHT PARTS...

A1 Rear Sight Parts... Highest quality Sight Parts for those who prefer the simplicity of the original A1 design.

- A1 Rear Sight Assembly... \$12.95 (A1 RSITE ASSY)** The original M16A1 configuration - adjustable with A1 sight tool or bullet tip.
- A1 Windage Screw... \$3.15 (8448534)**
- A1 Windage Drum... \$3.15 (8448535)**
- Rear Sight Flat Blade Spring... \$.55 (8448536)**
- A1 Windage Drum Detent... \$.55 (8448537)**
- A1 Windage Drum Roll Pin... \$.55 (MS16562-96)**
- A1 Drum Detent Spring... \$.55 (8448538)**
- A1 Sight Aperture... \$6.50 (8448539)**
- A1 Round Front Sight Post... \$3.95 (8448572)**
- Original M16A1 round post.**



BUSHMASTER SIGHTS, SCOPES & MOUNTS...

See Pgs. 40/41 for a complete Bushmaster Carbine Schematic Parts Diagram.

Sights and Sight Parts for DCM High Power Competition can be found in the Competition Parts & Accessories Section of this Catalog - Pg. 22

Adjustment Knob for A1 Rear Sight... \$9.95 (LMT-001K) This knob converts the A1 rear sight to the latest M16A1E1 configuration. The phosphate finished steel knob is knurled for quick adjustment (no sight tool needed) and more precise half-click calibration. Knob only - use existing roll pin for changeover.

Complete A1 Rear Sight Assembly with our A1 Adjustment Knob... \$14.95 (A1-RSIGHT-KIT) Includes Knob; A1 Sight Aperture; A1 Windage Screw; Flat Spring; Ball; Spring and Roll Pin



A2 Square Front Sight Post... \$5.50 (9349056)
Standard M16A2 steel square post design.

See our Competition Section (Pg. 22) for Sight Posts in two competition widths to suit your eyesight.

A2 Front Sight Post for Flat-Top Colts \$5.50 (9349056-M) Colt A3 Removable Carry Handle Sights are taller than A1 & A2 Rear Sights, and require an .040" taller Front Sight Post. Also for use with Swan Sleeves & ARMS #40 sight.

KNS Precision Front Sights... Quality replacement front sights for the AR15/M16 offering .010 diam. crosshair wires for a precise sight picture and hooding for reduced glare. The Tactical Model Dual Range sight (right) offers an adjustable elevation dot for close range targets below the long range crosshairs. Includes Allen wrench for adjustments, and spare vertical crosshair.

Standard Model...

\$39.95 (KNS1)

Wide Hood Model...

\$37.95 (KNS2)

Tactical Model...

\$52.95 (KNS3)



Williams Fire Sight for AR15/M16... \$ 42.50 (9349054FSB-WFS) This front sight design incorporates a light gathering element for low light situations (the tubular piece that mounts along front edge of the AR sight base). The assembly is fully elevation adjustable, and all sight pieces are CNC machined of black finished aluminum. No drilling or tapping is required for installation on your front sight base.



Aluminum Scope Mount... \$21.95 (RAY-002) An anodized, machined aluminum, "see-thru" Picatinny rail mount (Weaver also) which allows use of existing iron sights. It attaches to the carry handle with a thumbnut.



Front Sight Replacement / Repair Parts...

Front Sight Detent... \$1.50 (8448573)

Front Sight Detent Spring... \$.85 (8448574)

Front Sight Taper Pin... \$1.00 (9349054BTP)

Complete Rear Sight Assembly for AR-15/M-16 Type Rifles... \$53.50

(AR A2 RSA) Latest M16A2 design with Dual Apertures and knob adjustment for elevation and windage. Dial in targets out to 800 Meters - in 100 Meter increments. Manganese Phosphate finished steel.

Also available, a complete 1/2 M.o.A.

Rear Sight Assembly for the A3 Removable Carry Handle... \$53.50 (Part # AR A3 RSA)

A2 Rear Sight Replacement/Repair Parts...

Rear Sight Elevation..... \$7.50 (9349066)

Rear Sight Elevation Index Screw..... \$1.00 (9349065)

Rear Sight Elevation Knob..... \$6.50 (9349067)

Rear Sight Elevation Spring..... \$2.25 (9349070)

Rear Sight Elev. Spring Pin..... \$.55 (MS16562-121)

Rear Sight Helical Spring..... \$.55 (9349069) [3 req'd]

Rear Sight Ball Bearing \$.55 (MS19060-4808) [3 req'd]

Rear Sight Windage Knob..... \$6.50 (9349077)

Rear Sight Windage Screw..... \$4.50 (9349076)

Rear Sight Windage Knob Pin..... \$.55 (MS16562-98)

Rear Sight Flat Blade Spring..... \$.55 (8448536)

Rear Sight Flip-up Aperture..... \$8.50 (9349075)

Rear Sight Base..... \$23.50 (9349074)

Trijicon Luminous

Tritium Front Sight Post... \$57.95 (CP-25F) This AR

type front sight post (shown right) is functionally identical to the standard front sight post and fits either A1 or A2 models and includes Sight Tool. Illumination from the Tritium inserts are guaranteed for 10 years by Trijicon.

Trijicon Rear Sight Aperture... \$38.00 (CP-25R)

An effective ghost ring style flip-up aperture for the AR. Houses two Tritium inserts in the larger aperture.

Trijicon Tritium Sight Set... \$89.95 (CP-25)

Both Front and Rear Sights as shown above, plus Front Sight Detent and A1/A2 Sight Adjustment Tool.



BUSHMASTER SIGHTS, SCOPES & MOUNTS...

The Aimpoint® CompM3...

Aimpoint created the CompM3 to offer police and armed forces personnel equipment able to handle any situation, anytime, anywhere. This revolutionary sight - with Aimpoint's 30 years of design innovation - features rugged construction, and revolutionary Advanced Circuit Efficiency Technology (ACET) that gives the sight unparalleled battery life and ease of use. The CompM3 works with any generation of night vision device (NVD) and is built primarily for armed forces and police use to hold up under the roughest physical handling and most severe weather conditions. The CompM3 is also ideal for hunters and sport shooters.



Aimpoint® CompM3 Sight... \$535.00 (11408) The Aimpoint Comp3 Passive Red Dot Collimator Reflex Sight offers capabilities not found in other sighting systems... **Features include:**

- Compatibility with every generation of NVD
- ACET Technology allowing 50,000 hours of operation on one single battery (on setting 7 out of 10 - Battery Type: 1 - 3 Volt Lithium battery - included - type 2L76 or DL11/3N)
- 500,000 hours of use on NVD setting
- Magnification 1X - Reticle Size: 2 MoA
- Unequalled light transmission
- Submersible to 45 meters (135 feet)
- Replaceable outer black rubber cover offering protection and an additional stealth factor
- Unlimited field of view
- Unlimited eye relief
- Parallax-free
- Rugged, durable construction unaffected by extreme weather conditions
- No laser emissions that could be harmful to your eyes
- Mechanical switching for speed and reliability
- Increased aiming confidence
- Reduced training time and ammunition
- Switch - Dot Brightness - 10 settings - 4 NVD, 6 Daylight
- Body: Extruded, high strength aluminum, hard anodized, with dark graphite gray non-glare finish
- Lens Covers of black, non-glare thermoplastic elastomer
- Adjustments: 1 click = 10 mm at 80 meters = 13 mm at 100 meters = 1/2" at 100 yds
- Dimensions: Length - 130 mm (5.1") Width/height - 55 mm x 55 mm (2.2" x 2.2") Weight - include lens covers and protective rubber shroud - 270 grams (9.5 oz)



Aimpoint® 3XMag Magnifying Module... \$514.00

(11324) The 3XMag Module is designed for compatibility with the CompM3 Sight for maximum flexibility in the field. When combined with Aimpoint's patented TwistMount, the 3XMag offers the ability to switch in a split second from CQB (Close Quarters Battle) to semi-sniping and vice versa. Hunters can rapidly switch from non-magnifying to magnifying while still being able to keep their Aimpoint sight on their firearm. The versatile 3XMag also can be used as a handheld magnifying glass monocular for discrete observation and identification. Unique features include:

- Mountable on a rail system behind Aimpoint sights with either Aimpoint TwistMount (next page), or a regular 30mm ring
- Provides extended range to the operator
- No influence on point of impact — No need for re-zeroing the sight
- Magnification - 3X
- Eye relief at 5° FOV 40 - 90 mm / at full FOV 60 - 65 mm
- Body: Anodized aluminum, dark grey, rubber covered
- Body's bottom surface has 4 screw holes for other mounting alternatives
- Dimensions: Length - 110 mm (4.3") Width / Height - 44x41 mm (1.7" x 1.6") Weight - 200 g (7.1 oz)



ARMS Ring Mount for Aimpoint® CompM3... \$107.00 (10950)

This rugged ARMS Mount is specifically designed with a wide clamping cradle for the Aimpoint CompM3. It features a single ARMS Patented quick throw lever locking system which guarantees repeat zero on any Picatinny Rail - solid, quick, easy to mount on and take off. The ARMS "no-mar" pad incorporated into the throw lever protects the Picatinny rail's edges

BUSHMASTER SIGHTS, SCOPES & MOUNTS...

Aimpoint® SRP-M Quick Detach Mount for Comp M3 Sight... \$29.00 (10830) A solid, simple 30mm wide-ring high mount with a large knurled thumbnut for easy on / easy off attachment to any MIL-Std 1913 Picatinny Rail. Optical center over the top of the Picatinny rail is 26.1mm (+/- 0.1 mm) - may require a riser block for sighting over a standard AR front sight.



Aimpoint® TwistMount for 3XMagnifier... \$164.00 (11355) The recommended mount for the 3XMag is this Aimpoint Twist Mount - allows for quick attachment and detachment. Simply lift the rear lever, then twist 90° to remove the 3XMag - solid, fast, and fits any MIL-Std 1913 Picatinny Rail.

Spacer for Aimpoint® TwistMount... \$11.00 (11566) A companion piece to the TwistMount designed for "co-witnessing" between 3X Magnifier and CompM3 on same plane rails. It raises the 3XMag in the TwistMount to match the height of the CompM3.

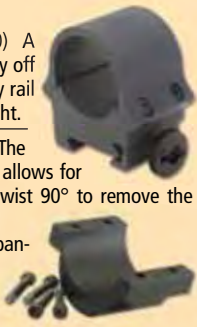

Trijicon Reflex Gun Sight for AR15/M16 with 4.3 Minute of Angle Sight Dot... Military evaluations have proved that "this sight is a winner" - a rugged system with no switches to turn off, or batteries to change. The fluorescent fiber optic system glows brightly during the day and varies in brightness automatically according to target area ambient light. The aiming dot is illuminated by light from the target area and from a tritium lamp, providing optimum target contrast at all times while eliminating the need for battery power. The reflex sight aids the human sense of balance while aiming with both eyes open. Hunters and competition shooters will also appreciate how quickly this sight puts you "on target". The AMBER aiming dot is far superior to traditional red dots because of the human eye's sensitivity to amber. The 4.3 MoA dot is small enough to avoid covering too much target at distances, but large enough for close range, quick target acquisition.



- **4.3 M.o.A. Dot Reflex Sight... \$428.95** (RX05-14) with Amber Dot Reticle and Mount for Flat-top Receivers (shown above)
- **4.3 M.o.A. Dot Reflex Sight... \$472.50** (RX05-10) with Amber Dot Reticle and Mount for A2 Carry Handle Receivers

Additional Trijicon Reflex Sight Models...

- **6.5 M.o.A. Reflex Sight... \$505.95** (RX01-10) with Amber Dot Reticle and AR15/M16 Carry Handle Mount
- **6.5 M.o.A. Reflex Sight... \$484.95** (RX01-14) with Amber Dot Reticle and AR15/M16 Flattop Mount
- **4.3 M.o.A. Reflex Sight for M4A1... \$495.00** (RX01NSN) This sight is specifically designed for the M4A1 and supplied to U.S. Special Forces with Amber Dot Reticle, Flat-top Adaptor, Polarizing Filter, and Dust Cover.

Reflex Sight Accessories... Genuine Trijicon accessories - fit all Reflex models with sunshades (as shown above).

- **Polarizing Filter for Reflex... \$19.95** (RX20)
- **Lens Dust Cover for Reflex... \$8.50** (RX21)
- **Anti-Glare Filter for Reflex... \$44.95** (RX22)

The Trijicon A.C.O.G. (Advanced Combat Optical GunSight) for AR15/M16... \$975.00 (TA01) The finest optical design, 100% U.S. made components and Mil-C-14806A multi-layer coated glass elements make the ACOG the ultimate telescopic sight. Tritium elements cause the black daytime reticle in the ACOG 4x32 to glow red at night and in low light. A forged aircraft aluminum housing is precision machined and hard anodized to match the finish of the M16. The ACOG's unique internal adjustment system (only the prism housing moves) makes this the most rugged scope available - it will withstand exposure to temperature extremes, salt spray, fog, fungus, humidity, sand, dust, shock, vibration and aerospace seals make the ACOG waterproof. A see-through channel in the integral base permits use of the iron sights while the scope is mounted. Attachment to the rifle's carry handle is with one or (optionally) two screws. Trijicon ACOGs are adaptable to H&K; Sig 550; Beretta AR 70/90 with various A.R.M.S. adaptors. Dovetail adaptors for popular hunting/target rifles are available.



TA01 Reticle



Trijicon TA51 Mount for ACOG... \$84.95 (TA51) Knurled thumbnuts allow quick installation/removal on any mil. spec. Picatinny rail flat-top model. The ACOG Scope (above) mounts into the center channel with two screws - use Loctite to keep it from "shooting loose".



BUSHMASTER SIGHTS, SCOPES & MOUNTS...

Trijicon ACOG TA01NSN Special Forces Sight...

\$1115.00 (TA01NSN) This Trijicon ACOG fits the AR15/M16 "flat-top" rifles and includes the TA51 Flat-top Mount shown here. ACOG is an acronym for Advanced Combat Optical Gunsight - and this one is the choice of many Special Forces groups. It has been designed to withstand shock, vibration, temperature extremes, water, dust, sand and hard surface drops. Unique modifications to this model include an integral rear ghost ring aperture and a tritium glow-in-the-dark front sight for close combat back-up sighting. This model's TA51 Mount also works with the Trijicon TA01, and is sold separately on previous page.



TA01NSN Reticle Representation



EOtech 510 HDS HOLOGraphic Diffraction Sight (HDS)...

\$379.00 (EOT-510) ...is the first system to apply holographic technology to small arms. When used in Close Quarter Battle (CQB) environments, this revolutionary optic delivers amazing speed and accuracy, uncompromised use of peripheral vision, and leaves no muzzle signature. The EOtech 510 HDS delivers speed gains for the initial weapon presentation, in multiple target situations, and in conditions where either the operator or the threat(s) are moving rapidly. Engaging around physical barriers or in awkward shooting positions are easier while ensuring rapid reticle to target lock-on. The HDS locks onto the target as fast as your eyes do, and has been designed and tested to provide consistent, reliable performance even in the most hostile operational environments. It is waterproof, fogproof, shockproof, and temperature proof. The Heads Up Display is constructed with a 3 layer, 3/16" thick shatterproof laminate glass for durability. Additional protection of the Display is provided with a rugged "roll bar" type hood. The HDS does not emit any muzzle side position revealing light signature - the projected reticle pattern is visible only to the operator. N Battery powered with a 1 M.o.A. aiming dot.



Representation of EOtech Reticle



EOtech 512 Holographic Weapon Sight... \$399.00 (EOT-512) The

EOtech 512 Holographic Sight has become EOtech's most popular sight in the commercial market as it will run on 2 AA batteries (lithium, alkaline [included], or rechargeable) for 1100 hours continuous at a reticle brightness setting of 12 (20 settings total). It mounts to any Picatinny rail standard on the flattop receiver AR15, M16 or M4 type weapon, or any Weaver dovetail rail, with an integral mounting mechanism tightened by means of a large knurled thumbscrew. Mounting on an AR15, M16 or M4 fixed carry handle requires addition of a Picatinny Rail mount (see Part# RAY-002 or the ARMS #2 mount). The AR15/M16 and M4 flat-top mounting platform provides for co-witnessing iron sights within the 512's Heads Up Display while maintaining the operator's critical cheek weld position. The Sight's Reticle offers a 65 MOA ring with a 1 MOA dot. Windage and Elevation adjustments are made by means of large slotted screws on the side of the case (use a coin, screwdriver or spent casing). The AA Battery compartment cover removes by lifting a locking lever on top, then lifting the battery case up and away from the sight. A rugged protective hood is built around the reticle. Sight length is 5 inches (131 mm) and weight with 2 AA batteries is 11.43 oz. (.32 kg).



This Eotech 512 Holographic Weapon Sight is equipped with the latest membrane switch design to provide excellent tactile response and positive snap feeling upon depression of the switches. Raised inlays around the switches provide a clear separation between brightness controls to ensure correct actuation. The 512 offers a convenient battery check feature so that if battery power is less than 20%, the reticle will blink on and off for 5 seconds. Additionally it will automatically shut down after either 4 or 8 hours depending upon which button (Up or Down) is used to power it up. Manual shutdown is performed by pressing both Up and Down simultaneously. EOtech offers a two year warranty against defects in workmanship or materials on the 512 Holographic Sight.

BUSHMASTER SIGHTS, SCOPES & MOUNTS...

EOTech Model 552 HDS Sight... \$479.00 (EOT-552) EOTech's Model 552 Holographic Diffraction Sight (HDS) features the rugged quality of all their models, but incorporates the convenience of common AA battery power. In normal operation, there are 20 reticle brightness settings in either 4 or 8 hour auto-shutdown modes. With "heads-up display" technology adapted from F-14 Tomcat Fighters, the Holographic Diffraction Sight is the first electro-optic sighting system to apply holographic technology to small arms.

The Model 552 features a night vision mode capability which can only be used with night vision equipment such as ANSPV7 Goggles or ANSPV14 Night Vision Scope/Goggle (must be used with night vision equipment to achieve full Night Vision Mode compatibility - but can be used as a normal holographic sight). With this system, 1 M.o.A. groupings can be achieved out to 300 yards. Windage and Elevation can be adjusted in 1/4 M.o.A. increments.

EOTech uses state of the art digital electronics design, and is waterproof, fog proof and shockproof. Twenty brightness levels ensure proper brightness control in either low light or bright sunlight. A microprocessor provides automatic battery check indicator, up/down brightness scrolling and programmable auto shut down features. All electronics are encapsulated in shock absorbing resin compound, and the HDS has been extensively tested on recoil simulators. The sight's tubeless design provides an unobstructed field of view for two-eyes-open shooting. Simply look through the 1/4" thick shatterproof laminate window, place the reticle image on the target and shoot. 1 M.o.A. aiming dot reticle patterns are instantly visible in even the lowest light, instinctive to center regardless of the shooting angle or position, and remain in view between shots. Additionally, anti-glare coatings on the optical surface eliminate any muzzle side reflective signature, and a rugged "roll-bar" hood protects the display. The EOTech HDS will mount to any Picatinny configuration rail.

EOTech Model 553 SOCOM Model HDS Sight... \$579.00 (EOT-553) Similar to the 552 above but includes upgrades to its switch mechanism and is submersible to 66 feet. Additionally, it has a new 7mm raised mounting base with dual ARMS Throw Lever mechanisms to speed installation and removal with no loss of zero. The EOTech 553 was extensively tested by US SpecOps Command and incorporates features required by SOPMOD Block 2.



Bennie Cooley Co-Witnessing Adjustable Mount...

\$165.00 (Part # EOT-12)



Absolute Co-Witnessing in EOTech Window



Co-Witnessing in Lower 25%

This sight mounting platform for the AR15/M16 is hailed as the most versatile co-witnessing mounting system made. It is vertically adjustable for easy alignment and custom fitting of any red dot optic (EOTech Holographic Sight, Trijicon Reflex, Aimpoint Comp or others) in relation to the iron sights of the rifle or carbine. It mounts into the A2 Carry Handle with a large hex-head nut/threaded post, and height adjustments are made to the Picatinny front rail with 8/32 button head retaining screws and the supplied 3/32 Allen wrench.

The I.O.R. Bucuresti 4 x 24mm M2 .223 Tactical Model... \$387.95 (IOR-B-4x24-M2) I.O.R. Bucuresti is one of Europe's oldest and largest optical factories. Versions of this scope have been in military service for over 30 years - all made to strictest military standards. It has a bullet drop compensated cam calibrated for the .223 cal. 62 grain projectile in ranges from 200 to 800 meters. For low light shooting, the seven stage battery powered reticle will assist target acquisition as it glows red. Batteries are the readily available 2032 3V Lithium type. The I.O.R. M2 .223 Tactical model features:

- a battery illuminated NATO Style Range-finding Reticle; an adjustable diopter; 30mm tube diameter; and a 29' field of view at 100 yards.
- a Carl Zeiss developed T3 lens coating system, with full multi-coating and anti-reflection treatment to eliminate glare and maximize light transmission
- "O" ring sealed 6061 T6 Mil. Spec. alloy housings
- Superior optical glass by Schott Glasswerk of Germany
- Nitrogen Filled / Waterproof / Fogproof / Shockproof



Rings not included



Representation of I.O.R.'s NATO Style Rangefinding Reticle

BUSHMASTER SIGHTS, SCOPES & MOUNTS...

I.O.R. Bucuresti Quick Detach Rings... Mount these fine I.O.R. scopes with matching I.O.R. 30mm heavy steel scope mount rings. Available in either medium or high versions, they feature sturdy quick-detach levers and four clamping screws on each ring assure a rigid mount with removability and a guaranteed return to zero. The High Ring Set (pictured here) is designed for the A3 type flat-top upper receivers.



- **I.O.R. Bucuresti Quick Detach Rings... Medium Height (1/2" rise) \$85.95 / pair** (IOR-B-QD-Ring-Me)
- **I.O.R. Bucuresti Quick Detach Rings... High (3/4" rise) \$99.95 / pair** (IOR-B-QD-Ring-Hi)
- **I.O.R. Bucuresti Ring Inserts...** (Not Pictured) Machined steel inserts for mounting 1" scopes in the 30mm ring sets shown...**per set of 4... \$21.95** (IOR-B-1in-Insert)

Leatherwood M-600 3-9x40mm Computer A.R.T. (Automatic Ranging & Trajectory) Riflescope for 5.56mm/.223 Rem. Caliber... \$389.00 (LW-40) Developed during the Vietnam war, and improved and in use in Iraq today, "Computer" design scopes don't require the shooter to be trained in range estimation or correction. By zooming the scope and framing a target of known size in the reticle pattern, the rifle is automatically set for the range to the target. Then the shooter just holds "dead-on", and the automatic calibration built into the Leatherwood Computer ART Scope does the work! The M-600 3-9 x40mm "Auto-Ranges" from 200 to 600 meters. Optics are bright and precise, "Computer" controls zoom smoothly from 3 to 9 power, and flip-up dust covers offer lens protection. Aircraft aluminum construction, top quality optical glass, clear control knob increment markings, a non reflective finish, and integral ring/Picatinny mounting clamp make this a complete sighting system.



Leatherwood M-1200 6-24x50mm Computer ART Riflescope for .308 - .50 BMG... \$619.00 (LW-50) This Scope - for .308 to .50 BMG Calibers - offers "Auto-Ranging" capabilities for ranges from 300 to 1200 meters (a shorter 200 meter range setting is also provided). This scope allows the shooter to adjust the scope for long range, and still have all the internal adjustment for initial zero and fine adjustment. Zoom power is 6x to 24x with a 50mm adjustable objective, and the reticle is a "No-Math" Mil Dot configuration. All air to glass surfaces are fully multi-coated to give a brilliant high resolution image, and adjustments are covered tactical type with 1/8 minute clicks. The scope is shown above mounted on a Bushmaster .308 rifle. This complete sighting system includes rings and a clamp-on flat-top mount that will fit both Picatinny and Weaver rails.



Leatherwood Hi-Lux 30mm Red Dot Sight... \$83.95 (LW-RD30) This compact Red Dot Sight for 5.56mm / .223 Rem. Caliber, and other Picatinny or Weaver Rail applications, was designed to offer quick target acquisition, and easy "two eyes open" shooting. After zeroing in the sight, just place the red dot on your target, and you're ready. The non-magnifying Leatherwood Hi-Lux 30mm Red Dot features a 1 M.o.A. Dot, highest quality optical glass, elevation and windage adjustments, heavy aircraft aluminum construction, and a matte black non-reflective finish. The brightness of the red sighting dot is controlled by an 11 position rheostat on the top of the sight with clearly marked increments on the control knob. That large knob also serves as the battery case - holding one long-lasting 3 Volt Type ECR2032 lithium battery. Ribbed rubber rings protect the sight body against knocks and drops, and mounting on your rifle's Picatinny/Weaver rail is made simple with the two knurled thumbnuts on the sight's integral base. The Leatherwood 30mm Red Dot is fully waterproof, shockproof and backed by a Limited Lifetime Warranty.



BUSHMASTER SIGHTS, SCOPES & MOUNTS...

Leatherwood Computer

A.R.T. Scopes Instructional

Video... \$10.95 (LTAPE)

Describes features and operation of the Automatic Ranging and Trajectory Computer Riflescopes. Sighting-in instructions and recommendations are included.

Riser Blocks for Picatinny Rail Flat-tops...

\$13.95 each (LW-RB)

These black anodized aluminum mounts clamp onto Picatinny configuration rails to offer the extra height necessary to achieve a proper sight picture and comfortable cheek weld on the buttstock when using scopes with the AR type rifle. They attach with Allen Head screws, and two risers are required for most mounting applications (one for each ring).



Leatherwood Hi-Lux 50mm Red Dot Rifle

Sight... \$105.95 (LW-RD)

This larger Leatherwood Red Dot Sight offers a 50mm viewing area with an 88 foot Field of View at 100 yards. It includes an integral Picatinny type rail mount with large thumb screw clamp nuts to make installation/removal easy and offers excellent repeat zero. The 1 M.o.A. red dot system is powered by a readily available ECR2032 lithium battery (included). Dot brightness is controlled by a twelve step rotating switch - windage and elevation adjustments are built in as well, and covered by protective caps. Construction is of robust aluminum throughout with high quality, fully coated optical glass protected by ribbed rubber edge guards front and rear. The Leatherwood 50mm Red Dot Sight is shown here on a Bushmaster Carbon Fiber .223 flat-top rifle, but is adaptable to many other firearms as well.



Simmons' new Master Series™ AETEC®

is one of the most innovative, high performance riflescopes ever designed.

Featuring Simmons' patented TrueZero™ flex erector system and new windage and elevation dials, the new AETEC delivers remarkably consistent shot placement and ultra-precise MOA adjustments throughout the entire range.



Simmons AETEC® Master Series

2.8 - 10 x 44mm

Scope... \$189.95

(2101)

Add Simmons' new QTA™ Quick Target Acquisition eyepiece, which delivers a constant minimum 3.5 inches of eye relief and one of the most generous eye boxes in the industry, and you'll have the confidence to know that your AETEC will get the job done from shot to shot and season to season. The aspherical lens system found on this quality scope was first used on expensive binoculars and cameras. Simmons has adapted this technology to the rugged AETEC scope - allowing a wide field of view with a completely flat image and edges that are as bright as the center. The Master Series AETEC 2.8 - 10 x 44 mm Scope offers longer eye relief than conventional wide angle systems and features a fully multi-coated lens system and 1/4 min. adjustments. True one piece tube construction is utilized - meaning the entire scope is machined - from premium grade aluminum - as a single unit from end to end. It is waterproof, fog proof and weatherproof, has Suregrip™ rubber coated adjusting knobs, and Hydroshield™ water and condensation resistant lens coatings. Innovations to the Simmons Aetec Scope include:

- Simmons' exclusive true one-piece tube construction for increased mounting area
- Aspherical lens technology and fully multi-coated optics for the brightest, sharpest image in its class
- HydroShield™ lens coating helps maintain a clear sight picture - regardless of weather conditions
- New SureGrip™ rubber surfaces on all eyepieces and side-focus parallax adjustments make the AETEC one of the easiest scopes to adjust in the field

| Description | Field of View (ft. @ 100 yds) | Eye Relief (inches) | Exit Pupil (Millimeters) | Weight (ounces) | Click Value (MOA) | Adjustment (Range) | Reticle Truplex | Parallax 100 yds |
|---------------|----------------------------------|------------------------|-----------------------------|--------------------|----------------------|-----------------------|--------------------|---------------------|
| 2.8 - 10 x 44 | 43.5/11.5 | 3.5 | 15.4 - 4.5 | 13.8 | 1/4 | 80/80 | | |
| Black Matte | | | | | | | | |

BUSHMASTER SIGHTS, SCOPES & MOUNTS...

Mark Brown Custom CQB-A3 Mount... \$209.95 (MBC-03) For any "flat-top" or V Match Upper, this mount incorporates a standard A2 rear sight (adjustable for windage and elevation). It is designed for most red dot type sights of 30-50mm tube diameter. Machined from aluminum alloy with a black anodize finish - steel sight parts are manganese phosphate finished. **Note: The EOTech and Trijicon Reflex Sight are too tall to work with this mount.**

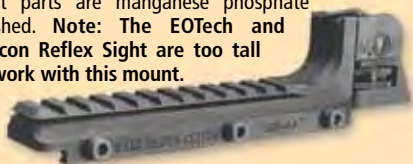

Aluminum Scope Ring Sets... \$15.95 per pair
Top quality, matte black finished ring sets to fit any Picatinny rail. U.S.A. made - heat treated aluminum with 8-32 socket head screws in 1" Low, Med. or High Profile horizontally split design. 30mm style is vertically split. Wrench included with each set. **Specify:**

- 1" Low (W-20524) / 1" Medium (W-20515)
- 1" High (W-20525) / 30mm Medium (W-20513)



Kwik-Site See-Thru Scope Mount and Scope Ring Set... \$53.95 (KSN-M16) For A1 or A2 rifles with the solid carry handle, this mount features a wide see-thru channel to enable the use of existing open sights. Mounts to the handle with a large thumbnut.

A pair of 1" (internal diam.) horizontally split scope rings is included with this set.



Snap-on Forearm Light Mount \$31.95 (HPM3) This heavy plastic base (shown installed, and separately) snaps onto AR-15/M16 Rifle Forends (won't fit the CAR handguards). Detents grip the forend vent holes for a firm mount. On the side, a rail segment is mounted which is designed to accept a variety of tactical flashlights (see SureFire Lights on Pg. 39 of this catalog).



M203 Grenade Launcher

Quadrant Sights for A2 & A3 Type Rifles... These are Government Issue Quadrant Sights for the M203 Grenade Launcher. Sights include a Flip-out Post & Aperture System, combined with an elevating scale set in 25 meter increments from 50m to 400m. There are models for both the A2 Solid Carry Handle rifles and carbines, and the A3 Removable Carry Handle type (they are not interchangeable).

- For A3 Removable Handle Rifles... \$105.50 (12598114)
- For A2 Solid Carry Handle Rifles... \$ 81.95 (9346304)



First Samco Tactical Light Mounts...

These mounts will accept 1" or 15/16" diameter flashlights and hold them solidly onto your rifle or carbine with an internal rubberized pad-clamp. It slides onto the First Samco M33 Handguard rail (see Page 54 in this catalog - or any Picatinny type rail - and locks in place with a rugged push button mechanism. Molded of high density black polymer.



- **First Samco 15/16" Tactical Light Mount... \$31.95** (FBS-FAS-3) For Streamlight Scorpion and other 15/16" diameter flashlights.
- **First Samco 1" Tactical Light Mount... \$31.95** (FBS-FAS-2) For Surefire & other 1" diameter tactical flashlights.

A.R.M.S. SIGHTS, SCOPES & MOUNTS...

A.R.M.S. #39A2 Bi-Level Rail... \$148.95 (ARMS 39) Mounts to M16A1 & A2 Carry Handle for multiple combinations of attachments, and provides rigid support of the dovetail platform that is extended over the handguards. A "brush breaker" on the front will prevent branches from snagging under the rail, and a "see-thru" channel in the #39A2 Upper Rail allows the use of existing iron sights.

Note: This Rail System will not mount on the A3 Removable Carry Handle.

See the A.R.M.S. S.I.R. System in the Handguards Section of this catalog - Page 38.



A.R.M.S. SIGHTS, SCOPES & MOUNTS... See the A.R.M.S. S.I.R. System in our Handguards Section.

A.R.M.S. #2 Scope Mount for M16A1/A2... \$68.95 (5855-01-299-777) An excellent handle mount type scope platform for the AR15/M16 rifles featuring the Swan universal mounting platform which accepts most all current military and police sighting systems, including NATO Stanag and Weaver type rails, without the need for adaptors. Other features include: see-thru channel for iron sight use; fast positioning with fixed toggle bolt; self-locking thumbnut - will not loosen; repeatable zero hold.



A.R.M.S. #5 MultiBase... \$68.95 (ARMS 5) A quick detach, multiple eye relief mount featuring a spring loaded clamping bar and NATO Stanag & Weaver rail fastening. Easily mounts to Picatinny/Weaver type rail or flat top receiver with locking, captivated thumbnuts.



A.R.M.S. #19 Weaver/Stanag Throw Lever Mount... \$159.95 (ARMS 19) Mount scopes, sights, etc. directly onto the A3 flat-top receiver with guaranteed repeat zero or, with an ARMS#2 carry handle mount, interfaces to M16A1/A2/M4.



A.R.M.S. #19A Throw Lever Channel Mount for ACOG Sights... \$170.00 (ARMS 19 A) The "channel" mounts Trijicon ACOG Scopes to mil. spec. Picatinny/Weaver rails with convenient A.R.M.S. repeat zero throw levers (positioned on left side so as not to obstruct the rifle's ejection port).



A.R.M.S. #40L Low Profile Flip-Up Rear Sight... \$119.95 (ARMS 40L) A design improvement on the ARMS #40 below, this sight achieves a super low profile (.610 height when folded) and uses the same rugged lock down quick release lever and "no knockdown" stainless steel retention spring. A unique "sandwiched" dual aperture flip-up combines a stationary close combat aperture and a 300 meter long distance accuracy aperture. The automatic zero stainless steel retention plate and clamping bar/pin won't rust, other parts are matte black finished. This sight includes a newly designed, miniaturized windage adjustment knob, will fit any mil. spec. flat-top Picatinny rail, and is as robust as the rest of the ARMS #40 series. It carries



U.S. Pat. No. 5,533,292. **Note:** This sight is designed to work in conjunction with the A.R.M.S. SIR System forends shown on Page 38. Due to the aperture height on this sight, you should order the .040 taller Front Sight Post on Page 64 of this catalog (Part # 9349056-M).

A.R.M.S. #40 Standard A2 Flip-Up Rear Sight... \$116.95 (ARMS 40) Similar to the sight on the Swan Sleeve system below, this U.S. Patented sight locks down with a quick release lever when not in use (shown in both deployed and lock-down positions). Its flip-up combines a 250-300 meter close combat aperture and a 500-600 meter aperture with a horizon line feature that helps lead distant targets. The automatic zero stainless steel retention plate and clamping bar/pin won't rust, all other parts are matte black finished - fits any mil. spec. flat-top Picatinny rail. The newest design of this sight includes a non-protruding, flatter windage adjustment knob. **Note:** This sight is designed to work in conjunction with the A.R.M.S. SIR System forends shown on Page 38. Due to the aperture height on this sight, you should order the .040 taller Front Sight Post shown on Page 64 (Part # 9349056-M).



A.R.M.S. Swan Sleeve... This rail sleeve with Integral Flip-Up Rear Sight provides a platform for various scope/sight mounts via the A.R.M.S. standard mil. spec. dovetail rail system. The spring loaded flip-up rear sight (shown "up") aligns with standard existing front sights but requires the taller (.040) front sight post - see Pg. 65). Except when locked down, the rear sight stays in battery, and provides windage adjustment with standard 250-300m range zero and a 500m horizon line setting. Currently used by U. S. Armed Forces, Swan Sleeves are strong, anodized aluminum alloy in three lengths with provisions to accept a wide variety of additional attachment rails, lasers or optics. **Specify:**

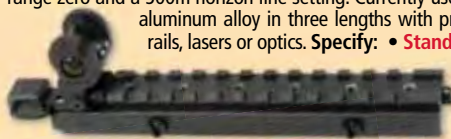

- **Standard Receiver Length...** (shown) **\$159.50** (ARMS 38std)
- **Extended Length (8.46")...** **\$175.50** (ARMS 38ex)
- **Super Extended Length (14" - includes "brush breaker")...** **\$190.00** (ARMS 38s-ex)

A.R.M.S. #22 Throw Lever Rings... \$123.50 per pair Patented 30mm steel rings secured with A.R.M.S. dovetail system to an extruded aluminum platform. "No-Mar" pads protect the rail and spring loaded levers act as shock absorbers - guaranteed repeat zero hold. Available in three heights: **Low - 1/4" rise** (ARMS 22L) / **Medium - 1/2" rise** (ARMS 22M) / **High - 3/4" rise** (ARMS 22H)



A.R.M.S. #37 Ring Inserts \$29.00 (ARMS 37) Steel inserts that allow use of 1" diameter scopes within 30mm ring sets.



BUSHMASTER MODULAR ACCESSORIES SYSTEM (B.M.A.S.)...

B.M.A.S. is a complete selection of quality accessories specifically designed to enhance the performance and versatility of your Bushmaster (or other brand) AR15 type Rifle or Carbine. They're all manufactured from superior materials to the tightest tolerances and quality standards - and in most cases, they can be easily installed with simple hand tools. Get into the "System", and get the most from your Bushmaster!

Bushmaster Modular Accessories System (B.M.A.S.) Front Flip Sight for V Match Rifles and Carbines... \$106.50

(Part # YHM-9360K) A high quality front sight that clamps around the V Match milled sight base/gas block - designed to be used with any open iron rear sight. This patent pending Front Flip Sight is machined from aircraft aluminum with an anodized finish, installs with an Allen wrench, locks up or down with a push button and is elevation adjustable. A standard front sight post is included, and the base is drilled and tapped for our B.M.A.S. Sling Swivel Stud (see YHM-9364 below). Sight shown installed at left, complete and deployed at right.



B.M.A.S. Flip Sight Sling Swivel Stud... \$4.95

(YHM-9364) Threaded 3/8 x 24 to fit the B.M.A.S. V Match Front Flip Sight above - accepts any quick detach type sling swivel like our KNS-4 on Pg. 58.



Bushmaster Modular Accessories System Detachable Front Flip Sight and Three-Rail Gas Block...

The B.M.A.S. Detachable Front Flip Sight (patent pending) is designed to clamp snugly on the gas block's top Picatinny rail with a pair of socket head screws for repeat zero every time. Machined from aircraft aluminum billet, it locks up or flips down at the touch of a button. A standard A2 front sight post with spring and detent locking system offers elevation zeroing just as with the original M16A2 sight system.

The B.M.A.S. 3-Rail Gas Block can be ordered on new barrels as a factory installed option, or we can factory retrofit existing sight bases on .750" diameter barrels. It's three rails are in standard Picatinny configuration to allow addition of flashlight or laser as side mounted accessories. The B.M.A.S. Three Rail Block is precision milled from alloy steel; finished in black manganese phosphate; and drilled and tapped on the bottom for the addition of a sling swivel stud (Note: this stud is not intended as a bipod mount).

- **B.M.A.S. Detachable Front Flip-up Sight only...\$77.50** (Part # YHM-9371K)
- **B.M.A.S. 3-Rail Gas Block only...\$56.50** (Part # YHM-9370)
- **Front Flip-up Sight/Three-Rail Gas Block SET... \$127.95** (Part # YHM-9370K)



B.M.A.S. Folding Front Sight/Gas Block...

\$94.95 (Part # YHM-9394) This Gas Block/folding Front Sight Combination is all steel construction, easily actuated with the push of a button, and locks in the deployed position. It includes a standard AR front sight post, detent and detent spring, and is the same weight as a standard AR sight tower. The sight's split design allows it to be mounted onto barrels that already have pinned or welded muzzle brakes or suppressors. It attaches easily with 4 cap screws (use of Loctite is recommended), and includes a Bayonet Lug and Sling Loop. All pieces are Manganese Phosphate finished for protection

against corrosion.

Shown flipped up in the foreground and folded in the shadowed image. This unit fits all

standard AR-15 type barrels with a .750" diameter at Gas Port.



B.M.A.S. Low Profile Clamp-on Front Sight... \$78.95

(Part # YHM-9584K) A low profile design Front Sight of quality alloy steel that folds flat at the touch of its side button to allow clearance for any large bell scope you might choose to mount. It flips up to lock in the deployed position with zero repeatability, and includes a standard, AR Front Sight Post and Detent System. Black phosphate finished - made in USA.



B.M.A.S. Fixed Clamp-on Front Sight... \$50.50

(Part # YHM-9495K) A standard height, fixed style front sight, this unit adds the convenience of a quick detach knurled thumbnut and clamping bar for easy removal. Returns to zero upon reattachment and includes standard AR Front Sight Post and Detent System - adjustable for elevation.



BUSHMASTER MODULAR ACCESSORIES SYSTEM...

B.M.A.S. Handguard Mounted Flip-up Sight... \$76.50 (Part # YHM-9627)

The Bushmaster Modular Accessories System solution to a handguard mounted back-up iron sight is this low profile, front flip-up unit. It attaches to any forend Picatinny rail, and folds down out of line of sight at the push of a button. It locks up in a deployed position, and mounts easily with a large knurled thumbscrew. Low profile, durable and lightweight all steel construction - manganese phosphate finished - includes AR square post, detent and spring - elevation adjustable.



B.M.A.S. Clamp-on Rear Flip-Up Sight... \$79.95

(YHM-9440) An aircraft grade aluminum, flip-up auxiliary sight featuring dual apertures, 1/2 M.o.A. windage adjustment, black anodized finish, convenient right hand adjustment knob and full height sight apertures. Height when folded is 1/8" lower than similar designs.

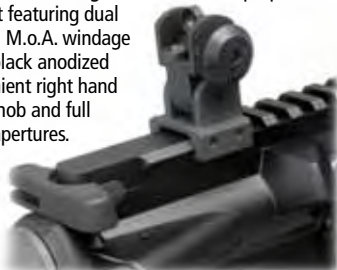

B.M.A.S. Flat-Top Fixed Rear Sight... \$116.95

(YHM-643K) This AR15 type fixed Iron Sight offers the option of mounting optics further forward on the flat-top rail. The sight's base is a heavy, black anodized aluminum block - other parts are steel. Windage and elevation adjustments are 1/2 M.o.A.



B.M.A.S. Low Profile Rear Flip Sight... \$95.95 (Part

YHM-9680) Bushmaster's flip-up rear sight for AR15 type Flat-top Receivers features a steel base, a quick release thumb screw, and an aluminum stem. This sight locks up (deployed position) with the push of a button, and folds down to .840 inches above the upper receiver. Windage adjustment is 1/2 M.o.A., and a standard dual aperture rear peep is fitted. Mounts to any Picatinny rail and will "co-witness" with standard AR15, M16 and M4 type front sights. Once sighted-in on your rifle, it can be removed and reattached with no loss of "zero" - also fits behind the A.R.M.S. S.I.R. System forends.



Bushmaster A3 Type Removable Carry Handle with 1/2 M.o.A. Rear Sight... \$116.95

(9349063-9) Add versatility to your "flat-top" - the Bushmaster Carry Handle clamps solidly onto the Picatinny Rail of any V Match or "Flat-top" Upper Receiver with two knurled thumbnuts, and includes an A2 Dual Aperture Rear Sight with 1/2 M.o.A. windage and elevation adjustment. Machined from aircraft aluminum forging, with steel sight and clamp parts.



B.M.A.S. Integral Flat-top Forend...

A Flat-top Forend System designed to fit the A3 type "flat-top" rifles or carbines - mounts using a replacement barrel nut (included - major disassembly of rifle required). With the new barrel

nut in place and aligned for the gas tube, the Forend slides onto the A3 Upper's rail, then locking screws and a "locking block" clamp it firmly in place. This system free-floats the barrel, and features a sling mounting plate with swivel stud. Machined from aircraft aluminum, finished in matte black hard anodized, and vented to keep weight down and barrel

heat to a minimum. The Low Profile Rear Flip-up Sight (YHM-9680 above) fits behind this unit on the A3 Upper.

For Rifles: (Part # P-12) \$292.95 / For Carbines: (Part # P-4) \$250.00

BUSHMASTER MODULAR ACCESSORIES SYSTEM...

B.M.A.S. 4 Rail Split Handguards...

Carbine Length - \$191.50 (YHM-9670)

Rifle Length - \$212.95 (YHM-9803)

The "split" design of these B.M.A.S. Handguard Sets allows quick and easy installation of a Picatinny configuration 4-Rail accessory system on most AR type Rifles (**Note: will not fit our DCM rifle or .308**). Machined of quality aircraft aluminum, they snap right in place of standard carbine or rifle handguards, and offer four full length rails for the flashlight/laser sight accessories of your choice. Rails are positioned at 12 - 3 - 6 - 9 o'clock, and the top handguard can be used in conjunction with an M203 Grenade Launcher. They're vented to keep your barrel cool, finished in mil. spec. matte black anodize to eliminate glare and protect against corrosion.

Rifle Length



Carbine Length

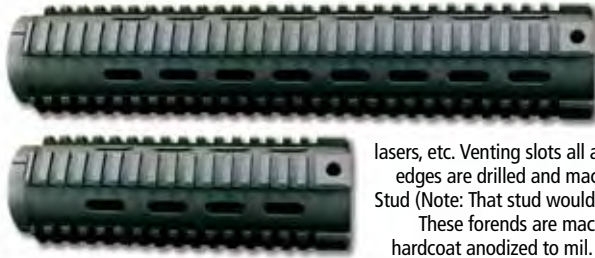

B.M.A.S. Four Rail Free Floater Forearms for Rifle and Carbine...

Four solid Picatinny rails machined into these free floater forends offer your AR type firearm unlimited mounting options for sights, scopes, grips, lights, lasers, etc. Venting slots all around aid in barrel cooling, and rail front edges are drilled and machined to accept the B.M.A.S. Swivel Sling Stud (**Note: That stud would not function as a bipod mounting point**).

These forends are machined from aircraft quality aluminum and hardcoat anodized to mil. specs. The rifle model fits 20" and longer barrels; the carbine version is designed for 16" barrels. Assemblies include forearm, barrel nut and jam nut.

Note: Barrel disassembly is required for installation.

Four Rail Rifle Forearm ... \$169.95 (YHM-9480) / **Four Rail Carbine Forearm... \$148.95** (YHM-9479)

B.M.A.S. Handguard Rails... Add an accessory mounting point to any standard Rifle or Carbine handguard with these Picatinny configuration Rails. Mounting requires removal of the handguard and inner shield - they screw through the existing vent holes. The anodized aluminum Rails are tapered so that mounted accessories will be on a level plane with barrel and bore, and they are vented to align with existing handguard vents for proper barrel cooling.



Handguards not included.

The Car Length Rail will fit on a Rifle length handguard if desired. As handguards have the possibility of movement, we do not recommend installation of optics or lasers on these rails.

B.M.A.S. Rail for Rifle Handguard... \$63.95 (YHM-Hgd-Rail-Rif)

B.M.A.S. Rail for CAR Handguard... \$54.95 (YHM-Hgd-Rail-CAR)

B.M.A.S. Rail Extension... \$37.95 (YHM-9474) This 5" rail extension attaches to any flat-top upper receiver to raise and forward mount a variety of optics. Extension's height is the same (1/2") as our B.M.A.S. scope risers (next page). Shown at right on flat-top, and separately, it is precision machined of aircraft aluminum with a hard anodize finish.

B.M.A.S. Quick Detach Rail Extensions - Available in 4" - 7" - 11.25" Lengths... These precision machined Rail Extensions - in standard Picatinny rail dimensions - mount on all AR15/M16 flat-top Upper Receivers to elevate the scope/optic mounting surface approx. 1/2". The two longer lengths can join and solidify the Upper Receiver

to any Four Rail Forend offering the extra mounting surface length necessary for very large/long scopes or "scout-style" mounting. All 3 Rails offers the convenience of quick detach/reattach with knurled thumbnuts. Anodize finished machined aluminum with phosphated steel thumbscrews and clamping bars.

- **4" Q. D. Rail Extension... \$39.95** (YHM-9595)
- **7" Q. D. Rail Extension... \$62.95** (YHM-9592)
- **11.25" Q. D. Rail Extension... \$86.95** (YHM-9590)

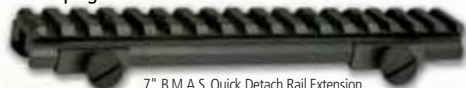

7" B.M.A.S. Quick Detach Rail Extension

BUSHMASTER MODULAR ACCESSORIES SYSTEM...

Bushmaster Modular Accessory System Scope Riser... \$32.95 (YHM-227A) This Riser / Rail Segment will solve the problems of scope movement or rocking that might be encountered with individual riser sections. A 5.25" Rail Section in standard Picatinny configuration will mount on any Flat-top Upper to raise the platform 1/2". Perfect on varmint rifles - accepts most types of scopes, red dot sights, and other optics. Machined from aircraft quality aluminum and hardcoat anodized to military specifications.



B.M.A.S. Multi-Rail Flat-top Riser... \$116.50 (YHM-9492) This riser for the AR-15 flat-tops clamps onto the Receiver's rail to allow see-thru use of existing iron sights while offering multiple rail platforms for optics, lights, lasers, etc. It includes threaded holes for a sling mount studs on either side, and is machined of aircraft aluminum with a hard anodize finish.



A.
1 1/4"
Length



B. 3/4" Length

B.M.A.S. Scope Risers... Increase scope mounting height on flat-top style AR's by 1/2 inch to achieve proper cheek weld (two Risers are required - one for each scope ring). Hard anodized aircraft aluminum, they fit all Picatinny/Weaver base dovetails.

A. 1 1/4" Length... \$15.95 ea. (YHM-226) / **B. 3/4" Length... \$13.50 ea.** (YHM-9490)

B.M.A.S. Angled Accessory Mounts... These handy mounts allow attachment of various accessories at a 45° angle on any "flat-top" Upper Receiver, or any multi-rail (Picatinny or Weaver type) forend. They are useful for flashlights or laser aiming devices, or with a pair, you could mount a scope in an "offset" position and still retain use of iron sights. Three different lengths are available: a "One Slot" type (3/4" length); "Three Slot" type (1 3/8" length); and "Five Slot" type (2 1/8" length). Machined from aircraft quality aluminum and finished in a matte black hard anodize, all attach to your rail surface with socket head screws.

One Slot Mount (A)... \$21.95 (YHM-9486A)

Three Slot Mount (B)... \$26.50 (YHM-9690A)

Five Slot Mount (C)... \$30.95 (YHM-9691A)



B.M.A.S. Triple Mount Rail Kit... \$84.95 (YHM-639K)



B.M.A.S. Front Sling Mount & Accessory Rail... \$78.50 (YHM-9574) Designed to clamp into the standard AR Front Sight, this mount combines a sling stud and Picatinny rail section for attachment of flashlight or laser accessories. Two discs fit into the sight, lock together with Allen head screws, then the rail screws into those and is oriented by means of the large knurled nut. Anodized aluminum with steel screws and stud.



Shown installed and separately.

B.M.A.S. Triple Mount Rail Kit... \$84.95 (YHM-639K) A quality multi-purpose accessory mount that clamps to the barrel of your AR rifle and fits around the front sight with three separate rail surfaces to allow mounting flashlights, bipod, laser sights, etc. Designed to fit both Post & Pre-Ban barrels (with bayonet lug), there are inserts included with this kit that allow fitting to either .720" diam. (20"/24") or .740" diam. (14.5"/16") barrels. This triple mount will accept all Picatinny/Weaver base attachments, and is machined from solid, black anodized, aircraft aluminum with Allen head clamping screws.

B.M.A.S. SuperLight Barrel Bushings... \$13.95 (YHM-640-4) This set of steel bushings fit the thinner Bushmaster SuperLight Barrels - order in addition to Triple Mount Kit above.



BUSHMASTER MODULAR ACCESSORIES SYSTEM...

B.M.A.S. Bipod Adapter \$31.95 (YHM-638) This attachment will adapt Harris (or other) bipods to the B.M.A.S. Triple Mount described on the previous page. Aircraft aluminum - black anodized to mil. spec. - with steel bipod stud. Mounts to any Picatinny or Weaver type rail.



B.M.A.S. Tactical Sling Adapter... \$14.95 (1005-914-2942-T) A Tactical Sling Adapter made for attaching various types of slings - allows mounting either web slings or those that have "lobster claw" type clips. This phosphate finished steel adapter plate replaces your telescopic receiver end plate, and allows ambi sling mounting on the primary, or offside shoulder position for a comfortable "tactical" carry. Stock and Receiver Extension removal is necessary for installation.



B.M.A.S. Folding Foregrip

\$79.50 (YHM-9640)

The mounting base on this broomstick style grip incorporates the B.M.A.S. push-button mechanism for fast deployment. Base mounts to any Picatinny rail with one Allen head screw - can be mounted to fold the handgrip forward or backward according to personal preference or other accessory usage.

Bushmaster Modular Accessories System Stock with Receiver Extension Tube and Buttplate Screw... \$96.50

(YHM-9569K) This kit is designed for those wishing to swap over completely from a telescopic, and includes all necessary parts from the Upper Receiver back. This new lightweight buttstock design features a strong shoulder buttplate piece affixed to a rubber covered, tubular "body". The solid aluminum buttplate has ridges to keep it from slipping on your shoulder. The stock is drilled and tapped in 7 locations for installation of a sling swivel stud (such as the B.M.A.S. Swiveling Sling Stud #YHM-9469). The tubular body of the stock is rubber covered for action spring sound deadening, and cheekweld comfort.



B.M.A.S. Rail Sling Mount... \$24.50

(YHM-9485S) Attach a sling to any accessory rail (Picatinny or Weaver type) with this B.M.A.S. Rail Sling Mount. Locks onto the rail with claw feet and clamps with an Allen Head Screw. Includes a Swiveling Sling Mount Stud.



B.M.A.S. Front Sight Sling Mount... \$31.95

(YHM-9468) This Bushmaster Modular Accessories System Sling Mount easily installs with three Allen Screws to position the sling along the side of the front sight for a comfortable carry (shown separately and installed). It includes a swiveling stud which accepts standard quick detach sling mounts.



B.M.A.S. Swivel Sling Stud... \$4.75

(YHM-9469) Fits our Four-Rail Forearms and other B.M.A.S. accessories to provide a sling attachment point that won't deflect the barrel when the sling is pulled tight. Rotates 360° - machined steel with black phosphate finish - threaded 5/16 x 32. Use with any standard Q.D. sling loop.



B.M.A.S. Solid Vertical Forearm Grip... \$36.95

(YHM-9400) Slides onto Picatinny rail forends and tightens with few twists to add stability and control of muzzle rise in rapid fire.



< B.M.A.S.

Forward Pistol Grip Assembly... \$42.50

(9349127-FWDGRP)

This unit combines a rail mount clamp with a standard AR A2 composite plastic pistol grip that allows easy attachment onto any Picatinny rail section.



Or, the B.M.A.S. Stock alone... \$68.75

(YHM-9569) ...is available. This assembly would utilize your existing rifle length extension tube - slips right over it and locks in place with the standard buttplate screw. All other features are as described at left.

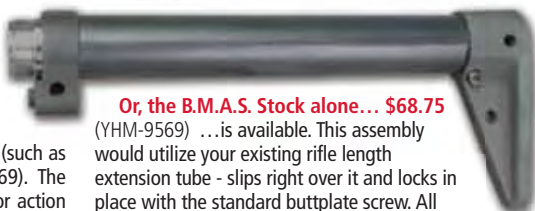

BUSHMASTER ACCESSORIES / APPAREL...

The **Bushmaster Rifle Case** is economical storage, or travel protection for your Bushmaster, or other firearms. With 47" x 9" x 3" dimensions, this case holds a full sized AR15/M16 rifle, or a scope mounted AR with receivers separated. It's a "clamshell" style design molded of durable black plastic with eggcrate foam lining and four snap closures. You can lock it with a padlock, and the Bushmaster name is molded into side panels.



Bushmaster Rifle Case... \$18.95
(Part #10483)

Shipping for 1st Case is \$7.50 / Addtl. Cases: \$6.00 each.

Eagle Padded Rifle Cases for AR Type Rifles & Other Firearms... \$79.95 Designed for professional use and sewn with craftsmanship and care of heavy #1000 denier black Cordura nylon. With closed cell foam padding for shock protection and additional water resistance, each case features a lockable outside cargo compartment; adjustable magazine pouches; reinforced 2" wide carrying handles; heavy duty YKK zippers; and a 2" wide, padded shoulder strap attached to welded steel D rings. These quality Eagle cases will fit most standard military type AR15/M16 rifles, but are useful as an all around carrying case for other rifles as well. Made by Eagle in the U.S.A.



• **Full Size Rifle Case... \$79.95** (RC-4123) Approx. internal dimensions: 40" x 11" (pictured here)

• **Carbine Sized Case... \$79.95** (RC-36) Approx. Internal Dimensions: 36" x 11" (like logo'd case below)

• **30" Carbine Sized Case... \$79.95** (RC-3223) Fits FNC, LAR Para 30" & Tele AKs

• **Extra Long Barrelled Rifle Case... \$79.95** (RC-4608) Approx. Internal Dimensions: 45" x 10" This case will fit FAL 44 1/2" & LAR-HB 45" rifles

Bushmaster Logo Embroidered Carrying Cases...



• **Bushmaster Logo'd Carbine Case... \$85.95** (RC-36A)

At left is our Bushmaster Carbine Case with the Snake Logo Embroidered in Red & White. Approx. Internal Dimensions: 36" x 11"

• **Logo'd Rifle Case... \$85.95** (RC-4123A)

A case for full sized rifles, with Bushmaster logo embroidered in red and white - same features and construction as Eagle Cases above. Internal Dimensions: 40" x 11"



Discreet Carrying Case for Carbines... When low profile is needed, and personal protection has to be readily available, this 32" black Cordura case does the job. Includes Four Interior Magazine Pouches (for up to 40 Rd. Mags) and a Padded Outside Pocket for accessories. Approximate Internal Dimensions: 32" x 13"

• **Discreet Case for Carbines... \$85.95** (DC-CAR-15)

• **Discreet Case for Rifles... \$85.95** (DC-M16/AR15)

A similarly styled model with Inside Dimensions of 41" x 13" - designed for full sized AR15/M16

• **Discreet Case for Uzi Short Bbl. SMG's... \$85.95** (DC-22) Approx. Internal Dimensions of 22" x 11"

The "Life Jacket" Safety Device for AR15/M16

Rifles... \$29.95 (LJ-1) "More secure than a Trigger Lock - more portable than a Safe" Lock up your prized AR with the Life Jacket. This tough polycarbonate clamshell enclosure locks up your AR type rifle and covers the entire action. Two separate keyed locks and keys are included. Foam padded interior protects your rifle's finish, and dual, tamper resistant hinge pins will secure almost all AR type rifles - with fixed carry handle or removable; all barrels with standard or DCM type free-floater firearms. **Note: To use the Life Jacket on a rifle with our V Match tubular aluminum forend, some material will have to be removed from the front opening.**

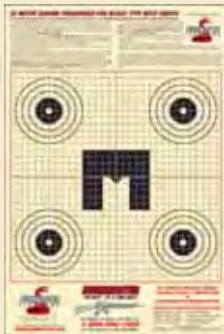

Bushmaster Sighting-in Targets... \$2.95 / Pkg. of 12 (QP-015K)

25 Meter Targets with complete instructions to get your AR Type rifle zeroed in right!

BUSHMASTER ACCESSORIES / APPAREL...

Ciener .22LR Caliber Conversion Kit for AR15/M16... \$169.95 (JAC-008A) Use .22LR ammo for target practice or plinking in your XM15 – AR15 – M16. This conversion kit contains all parts necessary to convert your rifle from gas operated 5.56mm/.223 Rem. to .22 Rimfire "blowback" operation. It eliminates overpower for indoor ranges and decreases noise in populated areas. No permanent changes are made to your rifle and it can be quickly returned to centerfire configuration. All parts manufactured of heat treated 4040 Chromoly steel. Includes Instruction Manual, Blowback Bolt, Hard Plastic Case and 10 Rd. Magazine. Made in U.S.A.

• **Extra Ciener 10 Round Magazines... \$42.50 each** (JAC-005A)

The Bushmaster Gun Pad... \$9.95 (QP-014) It's a sturdy counter-top protector for gunsmithing assembly work, and it doubles as a computer mouse pad (may not work effectively with an optical mouse due to red printed areas). This big (18" x 12") brightly colored pad has crisp images of the Bushmaster family of rifles and pistols - has laminated surface, and a soft, non-skid foam padded backing.



M9 Bayonet with Scabbard... \$109.99 (GCC-M9 BLK BAYO)

The BUSHMASTER M9 Multi-Purpose Bayonet System is designed to serve as a bayonet, a fighting knife, field knife and wire cutter. It fits many Bushmaster models as well as other M16 and AR15 type rifles and features a heavy 7.25" steel blade fitted with a checkered, black composite plastic handle. The blade is black oxide finished to reduce glare, and includes machined saw teeth on its back edge for light duty sawing. The M9's Scabbard is molded black composite plastic with an internal steel flat spring for bayonet retention within the scabbard. A nylon web strap with a snap closure also prevents loss. The lower tip of the scabbard incorporates a screwdriver blade and a wire cutting mechanism for barbed, and other wire. Bayonet overall length is 14.5" (36.8 cm) and weight is 28 oz. (.79 kg)

M9 Bayonet & Scabbard

Wire Cutting Feature of M9

M7 Bayonet with M10 Scabbard... \$34.95

(GC-BAYO SCAB KIT) Fits 20" & 14.5" Bbl. AR15/M16 and AR180 - a quality Gov't. type Bayonet and Scabbard made in the U.S.A.

NOTE... Bayonets are designed to fit only 14.5" & 20" Barrelled Rifles, and will only work with certain Flash Suppressors / Muzzle Brakes such as Birdcage types, Izzy Brakes; Phantoms; Mini & Y-Comps.

Consult Bushmaster Sales if you have questions about a particular application.

M7 Bayonet & M10 Scabbard

Bushmaster Blaze Orange

Hunter's Cap... \$10.95

(QP-0020H) A bright blaze orange cap of soft twill with an embroidered Bushmaster logo in Red, Black and White - "one size fits all" with an adjustable rear strap and buckle mechanism. Made in U.S.A.



Bushmaster Knit Caps...

\$9.95 each For colder weather

wear, these acrylic knit "tuk" style caps are snug and warm. Completely washable, they're embroidered with a three color Bushmaster logo on the rolled up area (avoids the feel of the embroidery on your forehead). Made in U.S.A. - available in 4 colors:

Orange Knit Cap... (QP-0020R)

Black Knit Cap... (QP-002B)

Navy Blue Knit Cap... (QP-002N)

Gray Knit Cap... (QP-002G)



BUSHMASTER ACCESSORIES/APPAREL



Bushmaster Canvas Cap... \$9.95 (QP-002BR) This new heavy duty Bushmaster Hat features our snake logo embroidered in Red, Black and White, and is sewn from a light brown canvas material (much like "Carhart" jacket material) - excellent on those cooler days. This "one size fits all" cap is adjustable to a wide range of sizes with a rear strap and buckle mechanism. Manufactured from heavy, quality foreign components and assembled in the USA.

Bushmaster Two-Tone Cap... \$9.95 (QP-002TTBR) With a look inspired by NASCAR, this Bushmaster Hat features the snake logo embroidered in red, black and white on a bright red and black cotton twill hat with white trim on the bill. Universally sized with an adjustable strap and buckle mechanism in the back. Quality Bushmaster headgear - assembled in USA from foreign components.

Bushmaster Black & Tan Caps... \$9.95 ea. We've embroidered our logo onto a soft brushed twill khaki tan cap or our traditional black baseball style cap. The embroidery is in red & white, or red, black and white, depending on hat color. They're durable, comfortable, and have an adjustable back strap so that one size fits all.



Black Cap... \$9.95 (QP-001) / **Tan Cap... \$9.95** (QP-001T)



Bushmaster Fleece Lined Jackets... Lots of the folks at the Bushmasterfactory stay warm all the Maine winter long with this Fleece Lined Jacket. It's Toughlan® nylon shell is windproof and water resistant, it has a winter weight 11.5 oz. fleece lining and 3 zippered pockets (2 outer & 1 inner) and our Bushmaster logo is embroidered in red and white on the left chest. Available in Black with Black Fleece Lining, or Khaki Tan with Green Fleece Lining. Order with the part numbers shown below followed by your size: **S - M - L - XL - 2XL - 3XL - 4XL - 5XL.**

Black Fleece Lined Jacket... \$69.95 (QP-8800BB & size)

Khaki Fleece Lined Jacket... \$69.95 (QP-8800TG & size)

Bushmaster Logo Sweat Shirts... Heavy Jerzees "Super Sweats" crewneck pull-over sweatshirts (50% cotton / 50% polyester) with the Bushmaster snake logo embroidered in red/white/black on upper left chest. Choose from Khaki Tan, Black, or Gray. Order with part numbers below and your choice of size: **S - M - L - XL or XXL.**

Khaki Tan Logo Sweat Shirt - \$27.95 (QP-021K & size)

Black Logo Sweat Shirt - \$27.95 (QP-021B & size)

Gray Logo Sweat Shirt - \$27.95 (QP-021G & size)

Bushmaster Logo Patch... \$2.95 (QP-012) A three color embroidered patch - 3" wide x 2" high. Great for sewing onto your range bag, shooting jacket, etc. to show your Bushmaster loyalty!

Bushmaster Logo Decal... \$1.95 (QP-013) 4 1/2" wide, screen printed red and black on white vinyl with adhesive backing for toolboxes, bumpers, gun cases or anywhere you want to display the Bushmaster Logo.



BUSHMASTER ACCESSORIES / APPAREL...

Bushmaster Logo Mug... \$4.95 (QP-016) Will your shot groups improve if you drink coffee from this Bushmaster logo mug? We hope so - let us know! Heavy, black ceramic mug printed red & white.



Bushmaster Embroidered Logo T-Shirt... \$14.95 Heavy weight and high quality, 100% white cotton T-Shirt with Bushmaster Snake logo embroidered in red and black on the upper left chest. Order Part# QP-007 Followed by Size: M-L-XL or XXL



NEW for 2007! - Bushmaster Long Sleeve Logo Embroidered T-Shirt... \$16.95 Heavy weight Black UltraBlend 50% Cotton / 50% Polyester Long Sleeved T-Shirt. Distinctive embroidered Red and Black Bushmaster Snake logo on the upper left chest.

Order Part# QP-022B-L Followed by Size: M-L-XL or XXL



Bushmaster Screen Printed T-Shirts... Quality 50/50 Blend Cotton/Poly Shirts in White or Black. The Bushmaster logo is silkscreened in two colors on the front left breast with larger logo variations on the back. Order with Part Numbers followed by size: S - M - L - XL or XXL.

Black ScreenPrinted T-Shirt... \$15.95 (QP-003 & size)

White ScreenPrinted T-Shirt... \$15.95 (QP-003W & size)



Back

Front



Back

Front

Bushmaster Sport Shirts... A 50/50 blend knit sport style shirt with collared, three button neck, available in either white or black. The Bushmaster logo is embroidered in two colors on the left breast. Comfortable, durable, and great for the field, range or sporting event. Order with Part Numbers below followed by size: S - M - L - XL or XXL.

White - \$24.95 (QP-002W & size) / **Black - \$24.95** (QP-002 & size)

Bushmaster Gift Certificates can be the ultimate gift for the shooter in your life - give them the freedom of choice with a Bushmaster Firearms Gift Certificate (available in amounts starting at \$10). Redemption of these certificates is very flexible - easily accomplished through our website, or by phone, fax or mail order. Just be sure to provide us the Certificate Number when placing your order (the actual certificate is not required - just the Certificate number from its lower right corner).

• **Phone Orders** - When ordering through our 800 number (1 800 998 7928), please tell our sales representative that you have a Gift Certificate and would like to use it, and provide us with the Gift Certificate Number. If your purchase total is higher than the Gift Certificate amount, you'll be asked for a Credit Card Number, Expiration Date and billing address so that we can charge any difference to your Credit Card.

• **Mail and Fax Orders** - When ordering via Mail or Fax, just write the Certificate Number next to the payment method.

• **Internet Orders** - choose Gift Certificate as your Payment Method and enter the Certificate Number in Certificate # Box.

Note: Bushmaster Gift Certificates can only be redeemed for Merchandise (not redeemable for cash), and are valid for one year from date of issue. See complete details on the internet, www.bushmaster.com or call 1 800 998 7928





Bushmaster Firearms International, LLC
999 Roosevelt Trail • P.O. Box 1479
Windham, ME 04062

Bushmaster Firearms International, LLC
1070 Metric Drive
Lake Havasu City, AZ 86403

<http://www.bushmaster.com>
Phone Orders: 1 800 998 7928

Your Source for the Highest Quality AR-15 Type Rifles, Parts & Accessories

The Best... By a Long Shot!

