

LEE

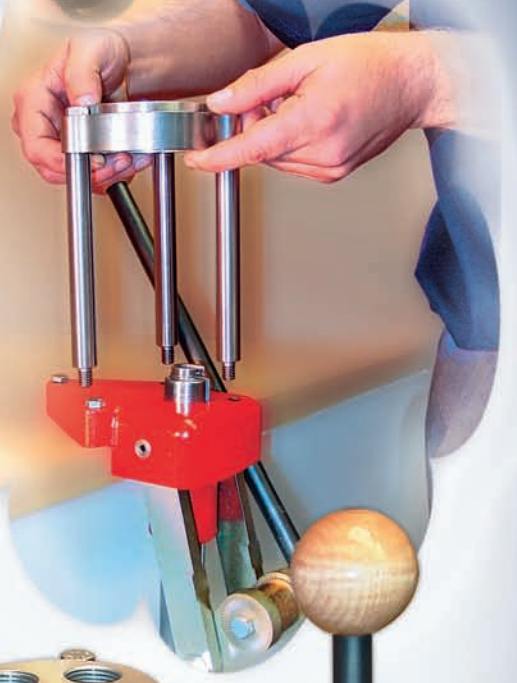

LEE CLASSIC TURRET PRESS

We have your dream machine

Page 15

2006 CATALOG \$1.00 LEE PRECISION, INC

- 2 Index · Reloading Made Easy
- 3 Factory Crimp Die
- 4 Pistol Dies
- 5 Carbide Pistol · Speed Dies
- 6 Pistol Die Features
- 7 Pistol Die Chart Sizes
- 8 Rifle PaceSetter · RGB Dies
- 9 Rifle Collet Dies
- 10 Rifle Die Chart
- 11 Rifle Die Chart
- 12 Lee Reloading Presses
- 13 Lee Reloading Kits
- 14 Lee Turret Press & Kit
- 15 Lee Classic Turret Press
- 16 Lee Classic Cast Press
- 17 Modern Reloading II Lee Loader
- 18 Lee Pro1000
- 19 Lee Load Master
- 20 Lee Powder Measures
- 21 Perfect Powder Measure Safety Scale
- 22 Case Conditioning Tools
- 23 Case Conditioning · Zip Trim
- 24 Priming Tools
- 25 Lube & Sizing Kit
- 26 Electric Melters
- 27 Production Pots · Accessories
- 28 Bullet Molds
- 29 Bullet Mold Sizes
- 30 Black Powder Equipment
- 31 Lee Load-All II · Slug Molds
- 32 Guarantee Shooters Program Accessories

You can buy and use Lee products with confidence. All products have been designed by Lee Precision and fabricated with the finest of materials. The exacting specifications and consistent high quality are maintained through strict controls and conscientious workers. All products come with complete, detailed “how-to” instructions. Dies and kits come with load data and powder measure. And every Lee product is covered under our unlimited two-year guarantee and lifetime warranty!

Reloading made easy!

Reloading becomes a simple process with quality Lee equipment and clear instructions



Remove spent primer and resize case

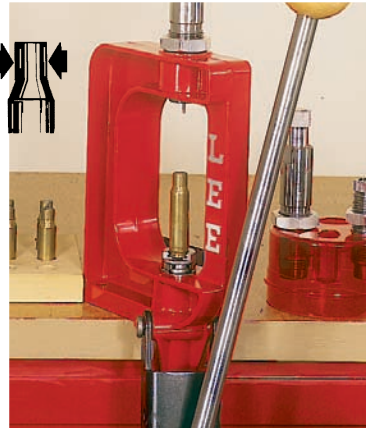

1 Remove the old primer and size the case. This is usually done with the same die. Cases can be full length sized or only neck sized for best accuracy.



Install new primer



2 Install a new primer. Picture shows this operation using the Lee Auto-Prime, the most popular priming tool ever made. (See page 24)



Add powder



3 Add a charge of powder. Lee dies, except RGB, include a powder dipper and extensive load data to tell you what kind of powder to use.



Seat a new bullet



4 Seat the bullet and crimp it in place. Full length sized ammunition is usually improved with a factory crimp. (See next page)

Save 60 to 80% over the cost of factory ammunition!

Overcomes the Factory Advantage!

Lee Factory Crimp Die

The Lee Factory Crimp Die crimps the bullet in place more firmly than any other tool. It is impossible to buckle the case as with regular roll crimp dies. Trim length is not critical. Tests demonstrate that even bullets which have no cannelure will shoot more accurately if crimped in place with the Lee Factory Crimp Die.

Factory ammunition is often more accurate and better able to withstand rough handling because the bullet is firmly crimped in place. A firm crimp improves accuracy because pressure must build to a higher level before the bullet begins to move. This higher start pressure insures a more uniform pressure curve and less velocity variation. Even powder selection is less critical. Until now, handloaders seated the bullet to touch the rifling to achieve similar results. This is not always possible nor desirable. The Lee Factory Crimp Die is included at no extra charge with Lee PaceSetter Dies. It's just another added value that only Lee Dies offer. **Lee Factory Crimp Die 12.98**

Most calibers not listed can be custom made for \$25.00. Available only from the factory. Allow six weeks and supply a bullet seated in an empty case.

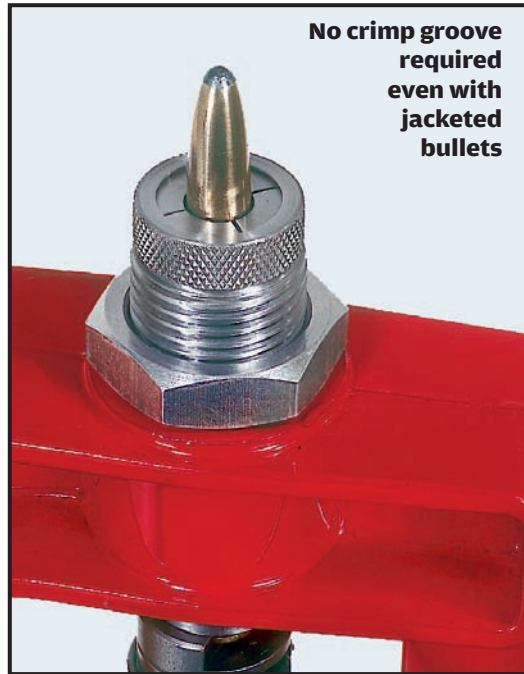

22 Hornet	90829
218 Bee	90830
222 Remington	90816
223	90817
22/250	90818
220 Swift	90831
243 Winchester	90819
6mm Remington	90832
243 WSSM	90187
25/20	90833
250 Savage	90834
257 Roberts	90835
25/06	90836
6.5X55	90837
260 Remington	90977
270 Winchester	90820
7/30 Waters	90838
7x57 Mauser	90839
7mm/08	90840
7mm Express	90841
7mm Remington Magnum	90821
7 STW	90869
7.62x39 Russian	90827
7.62x54 Russian	90842
32/20	90851
30 M-1	90421
30/40 Krag	90843
30/30 Winchester	90822
308 Winchester/303 Savage	90823
300 Savage	90844
30/06	90824
30/284	90066
300 Winchester Short Magnum	90331
300 Winchester Magnum	90825
300 Weatherby Magnum	90845
300 Ultra Mag/300 H&H	90970
7.5x55	90184
7.65 Argentine Mauser	90846
7.7 Japanese	90847
303 British	90826
8x57 Mauser	90848
348 Winchester	90857
338 Winchester / 338-06	90849
35 Remington	90828
356 & 358 Winchester	90904
38/40	90852
38/55	90853
375 Winchester	90905
375 H&H	90850
416 Remington	90906
44/40	90854
444 Marlin	90855
45/70 Gov / 450 Marlin	90856
458 Win Magnum	90969

For handgun ammunition that must work!

Lee Carbide Factory Crimp Die



A carbide sizer sizes the cartridge while being crimped so every round will positively chamber freely with factory like dependability. The adjusting screw quickly and easily sets the desired amount of crimp. It is impossible to buckle the case as with a conventional bullet seating die. Trim length is not critical so this extra operation takes less time than it would if cases were trimmed and chamfered.

Revolver dies roll crimp with no limit as to the amount. A perfect taper crimp is applied to auto-loader rounds. The crimper cannot be misadjusted to make a case mouth too small to properly head-space. A firm crimp is essential for dependable and accurate ammunition—it eliminates the problems of poor ignition of slow burning magnum powders.

LEE CARBIDE FACTORY CRIMP DIE 18.98

32 S&W Long - 32 H&R	90067	roll
9mm Luger	90860	taper
380 Auto	90867	taper
38 Super & 38 ACP	90866	taper
38 Special & 357 Magnum.	90861	roll
40 Caliber S&W, 10mm Auto	90862	taper
41 Magnum	90416	roll
44 Magnum, Special, Russian	90863	roll
45 Colt & 454 Casull	90865	roll
45 ACP, 45 Auto Rim, GAP	90864	taper
455 Webley	90865	roll

Special Sizes available. \$30.00



New! Bottle Neck Pistol Factory Crimp Die

30 Luger	90175
30 Tokarev & 30 Mauser	90086
357 Sig	90076
400 Cor-Bon	90173

BOTTLE NECK PISTOL FACTORY CRIMP DIE 25.00

Taper Crimp Die

The Lee Taper Crimp Die is hardened steel designed to overcome crimp problems caused by poor die design. These dies offer little or no advantage when used with 1986 or newer Lee Dies as the crimp angle is already a modified taper crimp. Jacketed bullets must have a crimp groove.



TAPER CRIMP DIE 10.98

308 Caliber	90790
(for most 30 Caliber cases, 308 Win. or longer)	
30 M1 Carbine	90788
32 S&W Long	90779
32 H&R Magnum	90779
9mm Luger	90780
38 Super and 38 ACP	90780
38 Special	90781
357 Magnum	90781
10mm Auto / 40 S&W	90782
44 Special	90784
44 Magnum	90784
45 Colt	90786
45 ACP, 45 Auto Rim	90785
455 Webley Mark II	90785
45 Winchester Magnum	90785
454 Casull	90786
45 GAP	90785

The best dies money can buy

LEE CARBIDE DIES are used in commercial loading machines that cycle four to five thousand times per hour. You can't wear them out with personal use.

These are the most copied dies ever invented. The competition tries to copy our dies, but they come up short. Only Lee has put it all together to make the best pistol dies money can buy. Reloaders buy Lee Dies because they are the best made and have the most features. No other brand can compare!



Lee Deluxe Pistol Die Set

The Lee Deluxe Pistol Die Set combines the world's most popular carbide three-die set with the Lee Factory Crimp Die at a great price. No other die set at any price will produce more reliable or accurate ammo.

By separating the seating and crimping operation, you will benefit by greatly simplified adjustment. More importantly, the Carbide Factory Crimp Die post sizes your case assuring you that any round that passes through the die will chamber properly in your gun. This—plus all the other exclusive features on page 6—make this the best die set money can buy! Packed in our new flat, four-die box; air tight hinged cover keeps your precision machined dies in perfect condition.

Lee Deluxe Pistol 4-Die Sets

In the flat red box **43.98**

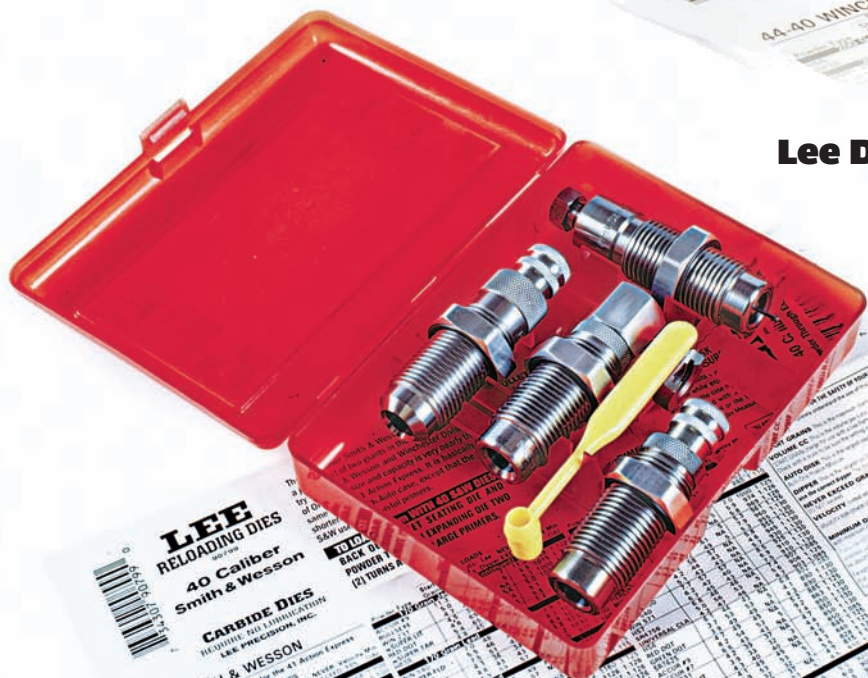

LEE
RELOADING DIES
40 Caliber
Smith & Wesson

CARBIDE DIES
REQUIRE LUBRICATION
LEE PRECISION, INC.

40 SMITH & WESSON
LEE PRECISION, INC.

DO NOT
POWDER T
(2) TURN

LEE
RELOADING DIES
44/40 WCF

HARDENED STEEL DIES
REQUIRE LUBRICATION
LEE PRECISION, INC.

44-40 WINCHESTER

WARNING:
DO NOT use the Lee Factory Crimp Die on cases that are not Lee Factory Crimp Die cases.

PARTS LIST

ITEM NO.	DESCRIPTION	QTY.	PRICE
1	44-40 WCF SEATING DIE	1	12.98
2	44-40 WCF EXPANDING DIE	1	12.98
3	44-40 WCF FACTORY CRIMP DIE	1	12.98
4	44-40 WCF DIE SET	1	38.94
5	44-40 WCF DIE SET (FLAT RED BOX)	1	43.98

Lee Carbide Pistol Dies

We use a solid carbide insert, ground to a special contour that does not leave the objectional belt mark on the case, common to ordinary carbide dies. With a carbide sizer, no case lube is needed, and you don't even have to clean your cases.

No need for a taper crimp die, plus better accuracy with Lee Dies.

Taper crimp dies are used to correct the problems caused by the improper expanding plug design or adjustment. They distort the bullet shank and reduce accuracy. Because the Lee Expander flares the minimum amount, consistent with easy bullet insertion, all of the flare is removed with the bullet seating die, thus eliminating the need for a taper crimp die.



**Lee Carbide 3-Die Sets
32.98**

Lee Steel 3-Die Sets
Same features as our premium carbide sets, except the case must be lubricated.

28.98

See chart on page 7 for the complete list of Lee Pistol Dies

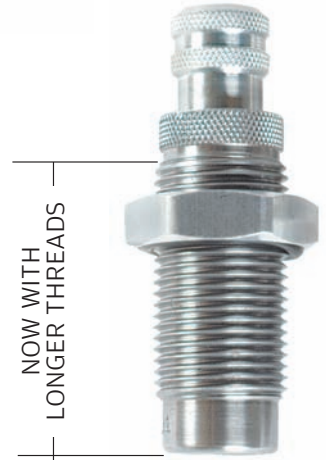

Lee Steel Pistol Dies



Notice the extensive list of recommended loads—another exclusive feature with Lee dies!

One die **replaces** three!

Lee Carbide Speed Die

The first significant pistol die breakthrough since the carbide die. When used in any single station press, the Lee Speed Die reloads faster than three die sets because you don't have to change dies between operations. Lee 3 die sets are faster when used in a turret or progressive press. Lifetime carbide sizer eliminates the need to lube your cases. This die is easy to setup and use.

See size chart on page 7

20.98



We supply what you need, and what you want! We have started millions in the fun and profitable hobby of reloading. Lee Precision is the only company that sells tools and dies with individualized instructions and load data. Every die set (except RGB Dies) has an instruction and data sheet specifically for that caliber.

exclusive features

LEE DIES RELOAD CARTRIDGES BETTER, EASIER, MORE ACCURATELY AND WITH FEWER PROBLEMS!



Unbreakable Decapper

It is guaranteed unbreakable for two years. Even if you misadjust it, or deprime military cases with crimped in primers, or even if you try to deprime Berdan cases, you will not break this decapper. The decapper is

accurately centered in the die with a collet rather than threads. Should you overstress it for any reason, it harmlessly slides up without breaking. Easy to reset after it has moved. No limit to the amount of times it can be reset.

Built-in stuck case remover

Should you ever get a case stuck in the die because you forgot to lube it, simply loosen the decapper collet and drive the case out by pounding on the end of the decapper with a drift punch and hammer.

Free floating bullet seater

The bullet seater is free to float and find its own center. This insures maximum accuracy because the bullet is seated axially perfectly with the resized neck. No chance for misalignment or deformed bullets. This feature is not found in any other brand of dies. Finger adjustable bullet seating depth. No "mickey mouse" lock nuts and screws to fumble with.



Powder Measure and Charge Table

Only Lee Dies come complete with a powder measure and charge table. An extensive list of proven loads that are safe and accurate. More extensive than some reloading manuals.

Storage is easy

Lee Dies are packed in a round box that permits storage of the turret with the dies installed. Slip the cover on and you have a dust tight container. Dies are always ready for instant reinstallation in the press.

Free Shell Holder

The price of Lee Dies include a free shell holder of the proper size. Other manufacturers charge nearly \$8.00 extra for this necessary part.

Carbide Sizers

All Lee straight sided pistol dies have carbide sizers. Carbide is so hard that it can be ground only with diamond wheels. No case lubricant is needed with carbide dies and they actually burnish the case to improve the finish. They will never wear out and cost no more than other manufacturers charge for plain dies.

Finger Tighten Lock Rings

Again, through the use of an "O" ring, the lock rings are easily adjusted and tightened with fingers only. No tools are needed. Yet, they will never loosen or move while reloading.



Exclusive

Powder Through Expanding Die

Only Lee Dies permit charging the case while expanding the case mouth. Every Lee 3-Die Set includes this Powder Through Expanding Die at no extra cost. The powder funnel adapter can be replaced with a Lee Auto-Disk Powder Measure for fully automatic powder charging while the case mouth is being expanded.

Lee Bullet Seat and Feed Die

This die updates older Lee Die Sets and all other brands to allow use of Lee Bullet Feed kits. Die has tapered ends to release bullet feed fingers, and is shortened to allow space for feed fingers while crimping. Included standard on most popular sizes.





DELUXE PISTOL DIE SET p.6

CARBIDE 3-DIE SET p.5

STEEL 3-DIE SET p.5

SPEED DIE p.5

CARBIDE SIZING DIE

POWDER THROUGH EXPANDING DIE

TAPER CRIMP DIE p.3

FACTORY CRIMP DIE p.3

CASE LENGTH GAUGE p.23

UNIVERSAL SHELLHOLDER p.24

AUTO PRIME SHELLHOLDER p.24

LEE LOADER p.12

	43.98	32.98	28.98	20.98	20.98	11.98	10.98		4.98	3.98	2.98	21.98
25 ACP		90568			S/O	S/O			N/A	90002	90017	
30 M1 Carbine		90626▲			90617▲	90494	90788	90421	90135	90524	90207	90253
30 Luger			90754			S/O		90175		90004	90023	
30 Mauser			90755			S/O		90086		90004	90023	
7.62 Tokarev			90769			S/O		90086		90004	90023	
32 ACP		90622			90621	S/O				SD3009	90207	
32 S & W		90696				S/O				90521	90204	
32 S & W Long *		90624			90621	90490	90779	90067	90169	90521	90204	
32 H & R Mag		90809			90621	S/O	90779	90067		90521	90204	
32/20			90751			S/O		90851	90146	90523	90206	
38/40			90761			S/O		90852		90001	90272	
9mm Makarov		90176				S/O			90684	90004	90023	
9mm Luger	90963	90509		90815	90548	90580	90780	90860	90153	90004	90023	90254
357 Sig			90270			S/O		90076		90004	90023	
38 Short / Long Colt		90276				S/O				90518	90201	
38 Colt NP					90619	S/O				90518	90201	
38 Super/38 ACP		90623			90619	90482	90780	90866		90004	90023	
380 Auto		90625			90618	90492	90780	90867	90155	90521	90204	
38 S & W		90569			90619	S/O			90156	90518	90201	
38 Special *	90964	90510		90811	90530	90581	90781	90861	90157	90518	90201	90257
357 Magnum *		90511		90812	90530	90582	90781	90861	90158	90518	90201	90258
40 S & W *	90965	90799			S/O	90620	90782	90862	90154	90004	90023	
10mm Auto		90566			S/O	S/O	90782	90862	90127	90004	90023	
41 Mag		90628			90629	90630		90416	90159	90526	90209	
44 Special *	90966	90516			90531	90583	90784	90863	90160	90528	90211	S/O
44 Mag		90512		90813	90531	90584	90784	90863	90161	90528	90211	90260
44 Russian		90293			90531	S/O		90863		90528	90211	
44/40			90564			S/O		90854	90168	90001	90272	
45 Colt	90967	90514			90533	90586	90786	90865	90163	90528	90211	90263
45 ACP	90968	90513		90814	90532	90585	90785	90864	90162	90519	90202	90262
45 Auto Rim		90808			90532	90585	90785	90864		90199	90213	
45 Schofield		90323			90532	S/O	90785	90864		90001	90272	
400 Cor Bon			90430			S/O		90173		90519	90202	
455 Web Mark II		90764			90533	S/O	90785	90865		90522	90205	
45 Win Mag		90810			90532	90585	90785	90864		SD3086	S/O	
454 Casull		90795			90533	90586	90786	90865	90992	90528	90211	
45 Gap		90498						90864		90519	90202	
480 Ruger ‡		90499							90018	90522	90205	
50 Action Express			90329			S/O				90528	90211	
500 S&W Mag		90288							90019	90003	90200	

* Can be used to load magnum cases
 ▲ 30 M-1 Carbine \$10.00 extra
 ‡ can be used to load the 475 Linebaugh
 S/O Special Order Factory Stock

Special Offer

Buy any Lee Die Set and you are entitled to purchase a **Lee Reloading Kit** with Press, Priming Tool, Powder Funnel and Case Lube for as little as **38.98**

SEE OFFER ON PAGE 13



Lee PaceSetter Dies

LEE PACE-SETTER DIES include the exclusive Lee Factory Crimp™ Die to produce factory-like ammunition with improved utility and accuracy. The die set also includes a conventional bullet seater and roll crimper. You can choose the type of crimp you desire. These dies are your best buy. They also include a shell holder, powder dipper, load data and are packed in the nicest storage box ever designed. These extras represent an \$18.00 value. Most of these extras are unavailable at any price from other suppliers. These are the most copied dies in the world. Every die comes with a written lifetime warranty, 2-year guarantee and **guarantee of accuracy or your money back!**

LEE PACESETTER DIE SETS
28.98

includes the exclusive Lee Factory Crimp Die

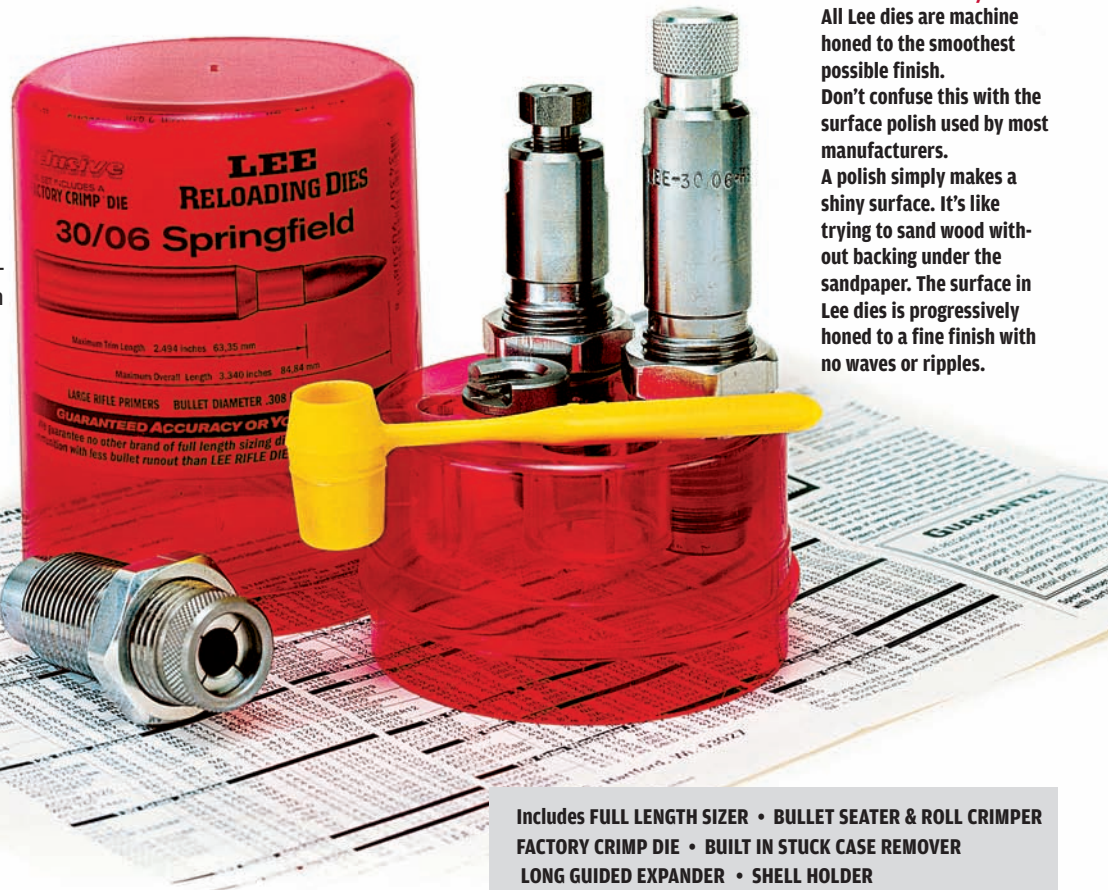

Includes FULL LENGTH SIZER • BULLET SEATER & ROLL CRIMPER
FACTORY CRIMP DIE • BUILT IN STUCK CASE REMOVER
LONG GUIDED EXPANDER • SHELL HOLDER
POWDER DIPPER • LOAD DATA & INSTRUCTIONS

Best Internal Finish in the Industry
All Lee dies are machine honed to the smoothest possible finish. Don't confuse this with the surface polish used by most manufacturers. A polish simply makes a shiny surface. It's like trying to sand wood without backing under the sandpaper. The surface in Lee dies is progressively honed to a fine finish with no waves or ripples.



Limited Production Dies

The same features and quality of our standard dies, but do not include a Lee Factory Crimp Die. The price is slightly higher because production quantities are lower. You'll find no better die at any price.

Half the price of competitive dies and theirs doesn't include load data which is priceless on odd or obsolete calibers. Our dies also include the correct shell holder and powder measure. Includes Shellholder • Powder Dipper • Load Data

LEE LIMITED PRODUCTION DIES

30.98



Lee Resizing Lubricant

Another first by Lee. We purchased the finest automotive deep draw lubricant and had it custom packaged exclusively for us. Lee lube is pleasant to handle and you can thin it with water. Non-sticky, nonallergenic. Very little is needed; it goes a long way. Eliminates stuck and dented cases and makes sizing less work.

Lee Resizing Lubricant

2 oz. tube

90006

1.98

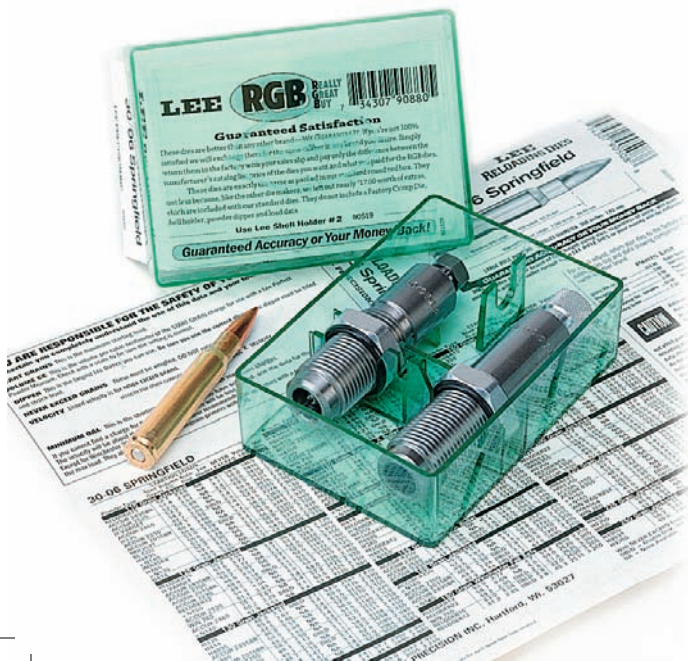

RGB Series Dies Really Great Buy!

Compare to other brands costing twice as much and you'll recognize what a fantastic bargain they are. We offer these only to show that when you buy Lee Dies – without all of the extras Lee customers have come to expect—the price is significantly lower, yet the quality is the best. Our tolerance is 50% less than the advertised amount of a popular and expensive brand. We guarantee these dies better than any other brand. If for any reason you're not 100% satisfied—just return them to the factory with your sales slip and pay the difference of what you paid and the manufacturer's catalog list price of the dies you want. We will ship them to you with our thanks for trying ours. These dies are a Really Great Buy. They cost less, because like other die makers, we left out \$18.00 worth of extras which are included in our PaceSetter™ dies. Do yourself a favor and check our PaceSetter dies. **RGB Series Dies only 16.98**



No lubrication required

Guaranteed accuracy

Extends case life 10X

Fastest to use

No cleaning or lubing required

Guaranteed to load the most accurate ammunition

Lee Collet Dies

There is no loading system that will load more accurate ammunition than Lee Collet Dies. We guarantee it in writing with every set. No one but Lee has ever dared make a guarantee like this **"Smallest group size or your money back."** A collet squeezes the case neck against a precision mandrel for a perfect bullet fit with minimum run-out. No case lube is needed. Cases last ten times longer, so the savings on only 35 cases will pay for the dies.

Maximum accuracy is usually achieved by seating the bullet out far enough to touch or almost touch the rifling. This provides the shot start pressure normally supplied by the crimp. That's why a dead length bullet seater is included to complete the most accurate reloading system ever made. These dies size only the neck to preserve the perfect fit of fire forming. Only reload cases that have been fired in your gun.

Not recommended for autoloaders, slide or lever action guns. See list of sizes on pages 10-11.

Lee Collet Die for neck sizing only **34.98**

Die sets include: Collet neck sizing die, dead length bullet seating die, shell holder, powder measure, charge table and storage box.

Most calibers not listed can be custom made for \$50. Send payment, two (2) fired cases and a bullet.

OR YOUR MONEY BACK!

Lee Deluxe Rifle Die Set

The Lee Deluxe Die Set is the most flexible and accurate die set available. The Lee Collet neck sizing die is enhanced by the addition of the patented Lee full length resizing die, which allows you to produce ammunition to factory-new specifications using cases fired in other guns. Your precision fire-formed brass can be used to reload the most accurate ammunition for your gun using the Lee Collet neck sizing die. No other die can produce more accurate ammunition. We are so confident, we guarantee it.

In addition to the best accuracy you get these benefits—

No case lubrication required
Reduced or eliminates case trimming
A ten times increased case life
Unmatched speed and convenience
Minimum bullet runout
Most uniform neck tension

Lee Deluxe Rifle Die Set **39.98**

Includes complete Collet die set plus full length resizing die



See pages 10 and 11 for the list of availability.

Special Offer

Buy any Lee Die Set and you are entitled to purchase a Lee Reloading Kit with Press, Priming Tool, Powder Funnel and Case Lube for as little as 38.98

SEE OFFER ON PAGE 13

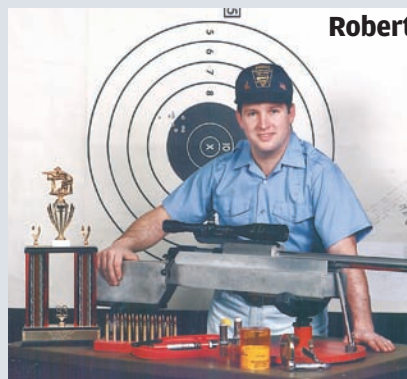

Robert Frey smashes world record with Lee Collet Dies

While competing in a regularly sanctioned 1000 Yard Match on July 25th, 1993, Robert Frey established a new 1000 yard world record. We're honored he used the Lee Collet Die to load his record setting ammunition.

World record breaker Robert Frey comments:

"The Lee Collet Neck Sizing Die enables me to get top accuracy from my rifles (match and hunting). The design principle of sizing the case neck to a mandrel is unmatched for accuracy potential by any other dies. It is one of the best ways to make all of my rifles shoot their tightest groups."

THE LEE EasyX EXPANDER

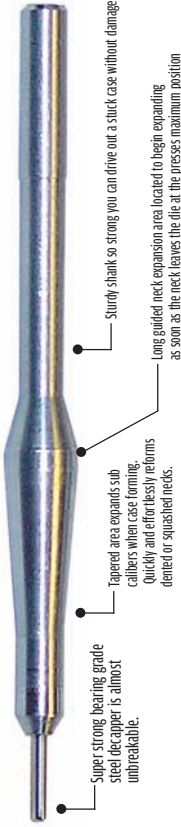

Now a feature in all Lee Rifle Dies

Sturdy shank so strong you can drive out a stuck case without damage

Long guided neck expansion area located to begin expanding as soon as the neck leaves the die at the presses maximum position

Tapered area expands sub calibers when case forming, quickly and effortlessly reforms dented or squashed necks.

Super strong bearing grade steel decapper is almost unbreakable.

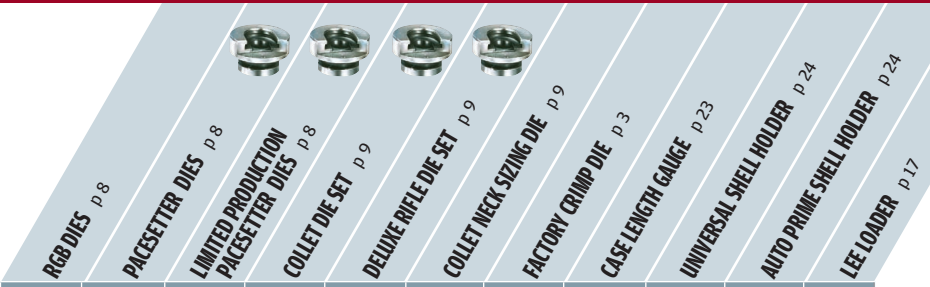

RGB DIES p 8
 PACESETTER DIES p 8
 LIMITED PRODUCTION PACESETTER DIES p 8
 COLLET DIE SET p 9
 DELUXE RIFLE DIE SET p 9
 COLLET NECK SIZING DIE p 9
 FACTORY CRIMP DIE p 3
 CASE LENGTH GAUGE p 23
 UNIVERSAL SHELL HOLDER p 24
 AUTO PRIME SHELL HOLDER p 24
 LEE LOADER p 17

	16.98	28.98	30.98	34.98	39.98	23.98	12.98	4.98	3.98	2.98	21.98
17 Remington			90770*	90804				N/A	90521	90204	
204 Ruger			90417*					N/A	90521	90204	
22 Hornet			90500	90705	90599		90829	90111	SD3590	90020	90265
218 Bee			90753				90830		90523	90206	
22 PPC				90803					90529	90212	
221 Fireball			90549*					90112	90521	90204	
222 Remington	90870	90501		90706	90602		90816	90113	90521	90204	
223 Remington	90871	90502		90707	90604	90954	90817	90114	90521	90204	90232
22/250	90872	90503		90708	90606	90955	90818	90116	90519	90202	90233
220 Swift			90542*	90702	90609		90831	90118	90527	90210	
223 WSSM			90446*					90673	90522	90205	
243 Winchester	90873	90504		90709	90610	90956	90819	90119	90519	90202	90235
6mm PPC			90796*	90802					90529	90212	
6mm Remington			90540	90710			90832	90120	90519	90202	S/O
243 WSSM			90990*				90187	90389	90522	90205	
25/20			90750				90833	90121	90523	90206	
25/35			90778*						90520	90203	
250 Savage			90550*	90704			90834	90122	90519	90202	
257 Roberts			90551	90703			90835	90123	90519	90202	
260 Remington			90298*	90974			90977	90993	90519	90202	
25/06 Rem			90536	90711	90605	90957	90836	90124	90519	90202	
25 WSSM			90413*						90522	90205	
264 Win Mag			90774*						90522	90205	
6.5 Carcano			90749*					90043	90519	90202	
6.5 Japanese			90730*						90527	90210	
6.5 Rem Mag			90773*						90522	90205	
6.5 x 55 Mauser	90874	90627		90712	90611		90837	90126	90520	90203	90271
270 Win Short Mag			90572*					90117	90522	90205	
270 Winchester	90875	90505		90713	90612	90958	90820	90128	90519	90202	90240
6.8 Rem SPC			90427*					90189	SD3391	90031	
7/30 Waters			90748*				90838		90520	90203	
7 x 57 Mauser			90541	90714			90839	90130	90519	90202	
7 x 64 Brenneke			90771*					90236	90527	90210	
7mm/08			90537	90723			90840	90167	90519	90202	
7mm Express/280 Rem			90552	90724			90841	90166	90519	90202	
7mm Win Short Mag			90573*					90314	90522	90205	
7mm Rem Mag	90876	90538		90720	90613		90821	90131	90522	90205	90242
7mm STW			90678*				90869		90522	90205	
7mm Ultra Mag			90979*						90522	90205	
284 Winchester			90777*					90129	90519	90202	
7.35 Carcano			90766*						90519	90202	
7.5 x 55 Swiss			90767*	90186			90184	90132	90520	90203	
7.5x54 MAS			90246*					90051	90520	90203	
7.62x39 Russian	90877	90565		90701			90827	90133	90529	90212	
7.62X54 Russian			90731				90842	90147	90003	90200	90243

*These dies do not include Factory Crimp Die S/O = Special Order Factory Stock

Exclusive Lee features included at no extra cost*

Lee dies are the most copied dies ever made. Lately other brands have started to offer some previously exclusive Lee features. Such as one piece reaming, wrench flats, collet held decapper, finger adjustable bullet seater, elevated expander and "O" ring locks. The competition still remains way behind. Because Lee dies are made to the tightest tolerance in the industry with unbreakable decappers, floating bullet

seater, heat treated to maximum hardness and polished to the smoothest finish. Every Lee rifle die set comes with guaranteed best accuracy in writing. This is in addition to the regular 2- year guarantee and lifetime warranty. See back cover for a copy of the guarantee included with every Lee product!

* with the exception of RGB Dies



Factory Crimp Die

Most popular rifle die sets are equipped with a separate Factory Crimp Die. This is in addition to the regular combination bullet seater and crimper. Be sure and read about factory crimping on page 3.



Free Shellholder

Others charge nearly \$8.00 for this necessary part.



FREE SHELLHOLDER included where shown

RGB DIES p 8
 PACESETTER DIES p 8
 LIMITED PRODUCTION PACESETTER DIES p 8
 COLLET DIE SET p 9
 DELUXE RIFLE DIE SET p 9
 COLLET NECK SIZING DIE p 9
 FACTORY CRIMP DIE p 3
 TAPER CRIMP DIE p 3
 CASE LENGTH GAUGE p 23
 UNIVERSAL SHELL HOLDER p 24
 AUTO PRIME SHELL HOLDER p 24
 LEE LOADER p 17

	16.98	28.98	30.98	34.98	39.98	23.98	12.98	10.98	4.98	3.98	2.98	21.98
30/40 Krag			90555				90843	90790	90137	90522	90205	S/O
30/30 Win	90878	90506		90716	90631		90822	90790	90136	90520	90203	90244
303 Savage			90756*					90790		90528	90211	
308 Winchester	90879	90507		90718	90614	90959	90823	90790	90139	90519	90202	90245
300 Win Short Mag			90942*	90185			90331		90034	90522	90205	
300 Savage			90545				90844		90138	90519	90202	S/O
30/06	90880	90508		90715	90615	90960	90824	90790	90140	90519	90202	90248
300 Win Mag	90881	90539		90722	90616	90961	90825		90142	90522	90205	
300 H & H			90560*	90726			90970		90141	90522	90205	
300 Weatherby Mag			90558	90727			90845		90143	90522	90205	
300 Ultra Mag			90698*				90970		90141	90522	90205	
7.65 Arg Mauser			90732				90846	90789	90134	90520	90203	
7.7 Jap			90733				90847	90789	90115	90519	90202	
303 British	90882	90547		90717	90654		90826	90789	90144	90522	90205	90247
32-40			90758*							90520	90203	
32 Winchester			90757*							90520	90203	
33 Winchester			90759*							90525	90208	
325 WSM			90923*									
8x56 R Hungarian			90925*							90003	90200	
8x57 Mauser	90883	90544		90719			90848		90148	90519	90202	
8mm Lebel			90768*							SD2827	N/A	
338 Winchester			90546	90721			90849		90149	90522	90205	
338 Ultra Mag			90927*							90522	90205	
348 Winchester			90760*				90857			90525	90208	
350 Rem Mag			90776*							90522	90205	
358 Winchester			90797*				90904			90519	90202	
35 Remington			90543	90728			90828		90150	90519	90202	
35 Whelen			90752*						90972	90519	90202	
38-56			90763*							90525	90208	
375 H & H			90559	90729			90850		90164	90522	90205	
416 Remington			90805*				90906			90522	90205	
43 Mauser			90806*							SD2980	N/A	
43 Spanish			90765*							SD2827	N/A	
32-20			90751*				90851		90146	90523	90206	
38-40			90761*				90852			90001	90272	
38-55			90762*				90853		90994	90520	90203	
375 Winchester			90563*				90905		90165	90520	90203	
40/65 Win			90986*							90525	90208	
44/40			90564*				90854		90168	90001	90272	
444 Marlin			90562*				90855		90151	90528	90211	
45/70 Govern			90561*				90856		90152	90525	90208	90264
458 Win Mag			90800*				90969		90971	90522	90205	

3 DIE SETS WITH POWDER THROUGH EXPANDING DIE



FREE SHELLHOLDER included

VERY LIMITED PRODUCTION 2-DIE SETS 35.98

- 90980 22/250 Ackley Improved
- 90981 223 Ackley Improved
- 90982 30/30 Ackley Improved
- 90983 416 Taylor
- 90984 6mm/284 Win
- 90985 6.5/300 Win Short Mag
- 90987 338/06
- 90988 257 Ackley Improved
- 90989 280 Ackley Improved
- 90951 30/284

1¼-12 Thread Series Dies \$100

These dies do not include load data
 90902 577/450 Martini-Henry
 90929 577 Snider

*These dies do not include Factory Crimp Die.

ALL 3-DIE SETS are packed in the round die box so you can store your dies installed in a turret



Load Data & Dipper

Complete load data with maximum and minimum suggested starting loads. This valuable data is not included with other brands and is unavailable anywhere for older and surplus cartridges.

Lock Rings

Finger tighten – set and forget, they never move. Just be sure to always loosen your dies by turning the ring, not the die. These have become so popular that we sell thousands of lock rings to people who want to update other brands.

LEE LOCK RINGS Set of 3 90534 3.98



Lee Die Boxes

The perfect storage for dies and dies assembled in a turret. Made from a tough, durable plastic.

ROUND DIE BOX 90535 2.98
 FLAT 2-DIE BOX 90078 2.98
 FLAT 4-DIE BOX 90422 2.98

Special Offer

Buy any Lee Die Set and you are entitled to purchase a Lee Reloading Kit with Press, Priming Tool, Powder Funnel and Case Lube for as little as 38.98

SEE OFFER ON PAGE 13

LEE PRESSES

all have compound leverage which permits full length sizing the largest magnum cases with ease.

All have built in spent primer catchers and a baked on epoxy finish.

All include individual detailed instructions for proper use in loading ammunition.

Make your selection according to need; based on price, speed and convenience.

For even greater bargains, consider the kits on pages 13 and 14

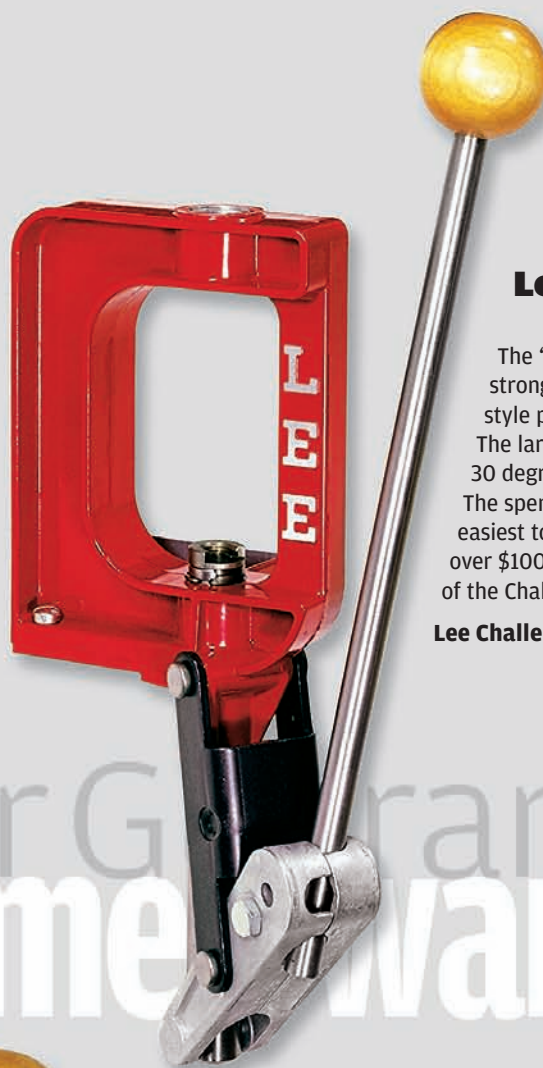

Lee Challenger Press

The "O" frame press by design is the strongest. This is by far the most popular style press.

The larger than average opening is angled at 30 degrees for maximum hand clearance.

The spent primer catcher is effective and the easiest to empty. This same style press costs over \$100 from other manufacturers without all of the Challenger's features.

Lee Challenger Press 90587 49.00

Two Year Guarantee
Lifetime Warranty



Lee Reloader Press

An outstanding value. Exclusive balanced lever that can't drop down to pinch your fingers. Unlimited hand clearance that only a "C" frame can offer. Works equally well with the right or left hand. Even if you already own a press, an extra press is always useful for decapping, bullet seating or bullet sizing.

**Lee Reloader Press
90045 28.98**



Lee Hand Press

A full size hand held reloading press, yet the tool weighs only 1½ pounds and costs so little you will want more than one. No matter how much equipment you have, it is really great to have a portable hand press. No time is wasted mounting a tool to a work bench. When you're finished, pack it all away.

**Lee Hand Press
90685 28.98**

These kits contain everything you need to begin reloading, less dies. The basic difference is in the press you select.

Everything you need to reload quality ammunition with the traditional "O" frame press.

This lifetime tool will pay for itself in the first hour or two of use. Save \$19 as a kit!

Challenger Press Kit



Dies not included

CHALLENGER PRESS KIT 90180

includes a

- \$49.00 Challenger Press
- \$11.98 Ram Prime
- \$2.98 Powder Funnel
- \$1.98 Case Sizing Lube
- \$65.94 Value

Special Offer

BUY ANY LEE DIE SET AND YOU CAN PURCHASE THIS KIT – LESS DIES

for only **46.98**

The perfect portable reloading press kit.

Begin reloading at once. No wasted time mounting to a work bench. Pack it all in the box when finished. Great for apartment dwellers or loading at the range.

Hand Press Kit



Dies not included

HAND PRESS KIT 90179

includes a

- \$28.98 Hand Press
- \$11.98 Ram Prime
- \$2.98 Powder Funnel
- \$1.98 Case Sizing Lube
- \$45.92 Value

Special Offer

BUY ANY LEE DIE SET AND YOU CAN PURCHASE THIS KIT – LESS DIES

for only **38.98**



A set of Lee Dies and this kit is everything you need to reload!

Anniversary Reloading Kit

Includes the popular, sturdy **Challenger Press** and instructions—a \$49.00 value. You get a complete powder handling system, with the most precise and repeatable **Perfect Powder Measure**. Plus the **Lee Safety Scale**, the most sensitive and safest of all powder scales. And the **Lee Powder Funnel** along with a powder data manual with over a thousand different loads tested and recommended by Hodgdon Powder Company—a \$62.94 value.

Case Preparation Tools include a cutter and lock stud to trim your cases. Order the correct case length gauge and shell holder for the caliber you will load. It's only \$4.98 extra. An inside outside case mouth chamfer tool and a tube of premium sizing lube is included. \$10.94 value. But that's not all! You get the most popular, because it's the best, **Lee Auto-Prime**, along with a set of shell holders for over 115 different cartridges. You even get a tool to clean the primer pockets. That's a \$38.94 value. Compare it to others priced at hundreds of dollars more. Reloading saves money and you save right from the start with Lee equipment.

Purchased separately it's a \$161.00 value!

Anniversary Kit 90174 113.98

Anniversary Kit

with "Modern Reloading Second Edition" 30.98 value, just \$12 extra

90962 125.98

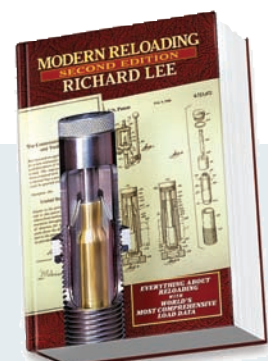



Lee Turret Presses are now equipped with the Lee Lever Prime System.[™] Priming on the press has never been more convenient

Lee Turret Press

Proven design with compound leverage. No spring in this turret design. The turret is locked into a solid steel ring with big rifle bolt type lugs. Patented design puts the lugs on the circumference so there can be no tipping. The linkage is so powerful that the largest magnum cases are sized with ease. Effort required is so small that the usual heavy bench is not essential. The Lee Turret Press has built-in primer catcher, longer stroke, more hand clearance and a comfortable wood grip. Even if you do not need all of these features, why pay more for anything less? In fact, you will want a Lee Turret Press even if you already own a more expensive one.

Four hole turret

By popular demand, the Turret Press is now available with a four station turret. This welcome upgrade allows you to install your Lee Factory Crimp Die, taper crimp die in the press. A simple conversion kit (below left) is available if you want to add this feature to your 3-hole press.

Lee Turret Press	90496	71.98
with Auto-Index	90576	85.98
4 Hole Turret with Auto-Index	90932	87.98

This is the best buy in reloading presses!



Power and strength to spare, plus unequalled convenience. The Turret Press is suitable for loading all rifle and pistol cases, but really shines when loading large quantities of handgun ammunition. This is the most convenient press made. Only a true progressive press is faster.

Includes the Lee Lever Prime System with large and small primer arms. Features lift out convenience. Works with the Lee Safety Prime.

Turret press owners!

Looking for a place to install that Lee Factory Crimp Die? Update your earliest turret press to the new 4-hole design. Includes everything required to convert your turret press to a four position auto index tool. Purchased separately your cost would be over \$42.00! Now at a special anniversary price!



Update Kit including free 4-Hole Turret 90933 20.00

If your turret press is without an auto-index, you will need to order a new ram - part number TA2269 (\$7.00) if you wish to install the Auto Index

Prime with push button convenience! Order the Safety Prime on facing page.

Lee Deluxe Turret Press Kit

The rugged Turret Press, along with the Auto Disk Powder Measure, produces top quality pistol ammo in a hurry. A finished round with a few pulls of the lever. Large enough to handle monster belted magnum rifle cases. When it's time to change calibers, simply lock in a new turret and begin reloading in seconds. In addition to the Turret Press and Auto Disk Powder Measure, the kit includes the Lee Safety Scale, unmatched for sensitivity, a primer pocket cleaner, cutter and lockstud to trim the cases and a chamfer tool to deburr cases after trimming. A set of Lee Dies is all that is required to complete this reloading outfit. All of this at a price that will allow you to pay for your investment in a matter of hours.

Deluxe Turret Press Reloading Kit		
3 Hole Turret w/Auto Index	90251	131.98
Deluxe Turret Press Reloading Kit		
4 Hole Turret w/Auto Index	90928	133.98



Your best buy for loading both rifle and pistol cartridges!

A MACHINE THAT DOES IT ALL



Lee Classic Turret Press

This press has all the features of the award-winning Turret Press with quality touches that make this the finest, most convenient press to own. The Classic Turret features the solid steel linkage of the Lee Classic Cast. Your first stroke of the hardwood gripped lever will convince you this is one, solid silky smooth press! The sturdy iron base shows its Classic Cast roots.

The long stroke allows rifle cases over three inches long to be loaded using the automatic index. Deactivate the Auto-Index and cases as long as the monster 50BMG can be loaded. The rigid cast iron frame supports the ram with over 12 square inches of area. The industry's largest ram is drilled completely through to dispose primers in an attached clear PVC tube. Every primer is caught — guaranteed.

Instant change turrets are the same as the famous Lee Turret Press. The Classic Turret uses the new Lee Lever Prime System · LPS · and the Lee Safety Prime tool makes priming on the press a delight.

If you like to own the best, then treat yourself to the Lee Classic Turret. The finest reloading system made.

Lee Classic Turret Press 90064 \$120



The Lee Auto-Disk Riser allows use of other brands of dies that have extended adjusting screws and provides clearance for the Lee Safety Prime.

90041 9.98

Lee Safety Prime

Makes priming on the press a delight. Never touch the primers from box to shell. Primer flip tray features a CAD designed flipping surface that instantly rights the primers. Change primer size in seconds. Primers are dispensed with a satisfying click of the primer feed trigger.

Lee Safety Prime

Small Primer Feeder	90995	20.00
Large Primer Feeder	90996	20.00
Large & Small	90997	30.00

Update Kit for pre-2006 presses 90042 40.00
Everything required to add primer feed - includes both large and small Safety Primer Feed



Get an additional turret for your Lee Presses

Why fool around with a single station press screwing dies in and out two and three times for each caliber? No longer is it necessary to use the batch system for reloading. Now you can load a complete round with several strokes. Those who want the utmost in convenience can purchase extra turrets and never remove the dies. Simply lift out the entire turret and replace with the next caliber. Dies, shell holders and primer arm can be changed in seconds without tools.



Extra Turret, 3 Hole
Extra Turret, 4 Hole



90497 10.98
90269 12.98

You don't need this fine a press to reload ammo – but it sure is nice! Lee Classic Cast Press

A rigid cast iron frame, cast and machined with pride in the USA, baked powder finish and all steel inkage make this one of the most attractive and sturdy presses made.



Spent primers are collected and drop into a flexible plastic tube for easy emptying.



Changes easily for left-handed use.



The largest opening in the industry and the longest stroke – yet handle is adjustable to provide the least handle travel of any press.

Rigid cast iron construction in a classic “O” design for maximum strength. Baked powder coating is durable and makes the Classic Cast a handsome addition to any reloading bench.

Large, flat cored base with 3 mounting holes mounts solid to any bench.

Adjustable handle is movable from right to left. The start and stop position is adjustable with a 48-tooth ratchet type handle clamp. In addition, the handle length is completely adjustable. Shorten it when loading handgun and short rifle cases.

Automatic primer arm with bottom of stroke priming for best feel. Includes two primer arms for large and small primers. No more fumbling with tiny guides and springs.

Largest 1½ diameter hollow ram to catch every primer with hose fitting to allow primer disposal directly to a trash can. Supported by over 12 square inches of ram bearing surface.

Threaded die adapter accepts standard 7/8 - 14 dies, remove and the press accepts 1¼ - 12 large series dies.

Powerful compound linkage with positive travel stop prevents press toggle or “cam over”.

Accepts standard shell holders, ram insert can be rotated to allow primer installation on right or left side.



LEE Classic Cast Press

90998 105.00

Small Primer Feeder 90995 20.00
Large Primer Feeder 90996 20.00
Large & Small 90997 30.00



50 BMG Die Set 1¼-12 Thread
90515 100.00



50 BMG Factory Crimp Die
90953 40.00

50 BMG Shellholder
90903 20.00

50 BMG Ram Prime Tool
90901 25.00

Lee Classic Cast 50 Caliber BMG Press Kit

At last, an affordable way to reload the monster 50BMG. This kit includes everything you need to start reloading the 50 — the **Lee Classic Cast press, set of 50 BMG dies, shell holder, ram prime tool and tube of case sizing lube.** Kit also includes shell holder insert, large and small primer arms and die reducer bushing to accept standard 7/8-14 dies so you can load all your smaller cartridges. All this for less than what others charge for dies alone.

50 Caliber BMG Press Kit 90859 231.00



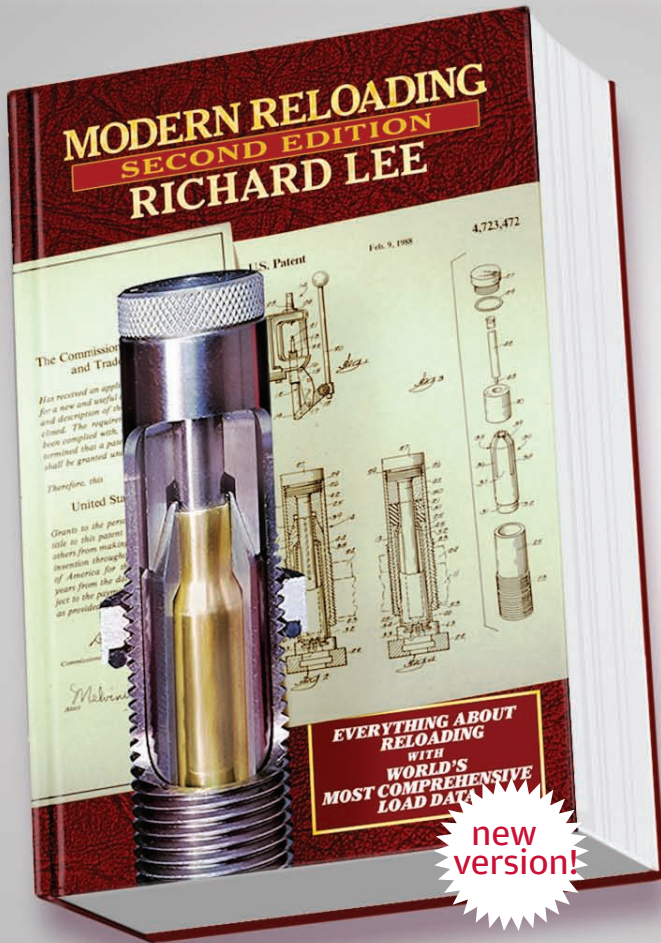

Everything about reloading with the world's most comprehensive load data

MODERN RELOADING Second Edition

BY RICHARD LEE

Learn how you can reload ammunition that is more accurate than factory ammunition on your first try.

The Second Edition of MODERN RELOADING is a summary of a lifetime of experience. No matter how knowledgeable you are, you will find new and interesting information in this book. It's a reference book you will keep forever.

OVER 26,000 LOADS in a new format, with velocities for starting loads. This the best kind of load data—it is supplied by the powder companies.

LATEST INFORMATION ON PRESSURE

NEW, EASY WAY to precisely measure both strength and hardness of cast bullets.

EXCLUSIVE PRESSURE AND VELOCITY factors enable you to accurately calculate pressure and velocity for reduced loads. An absolute necessity for cast bullet shooting.

A NEVER BEFORE PUBLISHED in depth analyses of current load data. It gives you an insight into the effects of reducing or increasing a charge

EASY TO USE cast bullet strength chart shows maximum chamber pressures for cast bullets.

HUNDREDS OF CAST BULLET LOADS many useful charts and important rules about priming.

Modern Reloading Second Edition 90277
a reference manual you'll keep forever

30.98

The Classic Lee Loader

LEE LOADER SIZES

22 Hornet	90265
223 Remington	90232
22/250	90233
243 Winchester	90235
6.5x55 Swedish Mauser	90271
270 Winchester	90240
7mm Rem. Magnum	90242
7.62x54 Russian	90243
†30 M1 Carbine	90253
30/30 Win (30 Rem).	90244
308 Winchester	90245
30/06 Springfield	90248
303 British	90247
45/70 Government	90264
9mm Luger	90254
38 Special	90257
357 Magnum	90258
†44 Magnum	90260
†45 ACP	90262
†45 Colt	90263

For more than 40 years, more shooters have chosen the famous Lee Loader for their first reloading tool than any other tool. They realize it is all they need for good, accurate ammunition. In fact, ammunition loaded with a Lee Loader held a world record listed in the Guinness Book of World Records for over seven years. Millions upon millions of rounds have been reloaded with the famous Lee Loader, and we expect it will continue to be a most popular reloader for many years to come. The perfect tool for those who wish to simply try reloading because it will pay for itself in just an hour or two.

Find out for yourself how much fun it is to reload with the Lee Loader. Everything you need to begin loading one caliber. You can save enough to pay for it in the first hour.

LEE LOADER 21.98

LIMITED PRODUCTION SIZES 23.98

These kits may not be stocked by most dealers. They are available for same day shipment from the factory.

225 Winchester 6mm Rem (244 Rem) † 44 Special † calibers require considerable force for sizing.



FULLY AUTOMATIC

Lee Pro1000

Add a bullet and pull the lever; all other operations are automatic. One loaded cartridge with each pull of the lever.

Every operation is automatic. Primers, like the powder, are fed only if a case is present. No wasted primers or spilled powder. Alternate loading sequence lets you load only one case at a time. Makes learning easy for the first time user and great for fine adjustments or experimenting. You can start reloading good ammunition minutes after the press is bolted down. Change calibers in 3 minutes.

32 S&W LONG and 32 H&R MAG	90639*
380 AUTO	90641
38 SPECIAL	90636
Can use for 357 Magnum	
357 MAGNUM	90637
38 AUTO and 38 SUPER	90035
9mm LUGER	90640
40 S&W	90682
10mm AUTO	90632
41 MAGNUM	90642
44 SPECIAL	90634
Can use for 44 Magnum	
44 MAGNUM	90635
45 ACP	90638
45 COLT	90643
223	90633
Includes Rifle Charging Die. Not available in carbide	

* requires MicroDisk

Lee Pro 1000 COMPLETE READY TO RELOAD 201.98

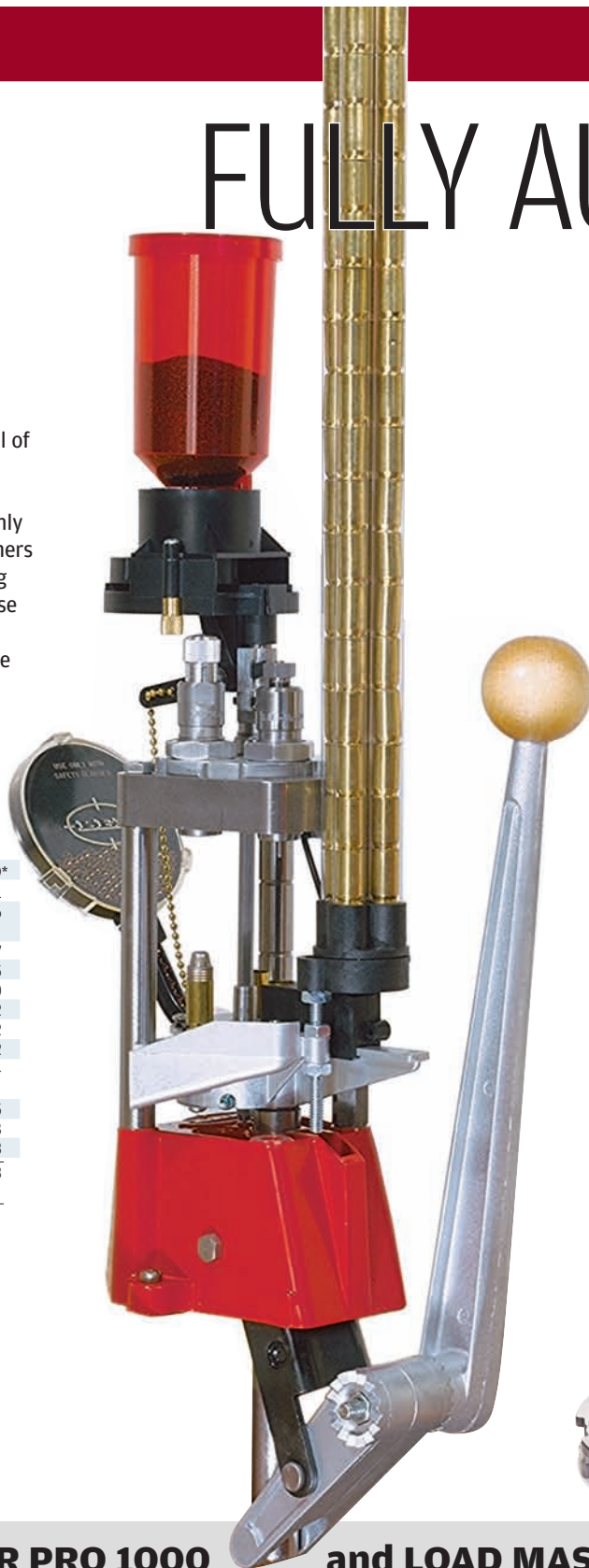

Shell Plates 20.00



SHELL PLATE #1	90651	38 SPL, 357 MAG., etc.
SHELL PLATE #2	90652	45 ACP, etc. 45 GAP
SHELL PLATE #2A	90664	45 WINCHESTER MAGNUM
SHELL PLATE #4	90653	222, 223, 380 AUTO, 32 S&W LONG 32 H&R MAGNUM
SHELL PLATE #6	90976	32/20, 25/20
SHELL PLATE #7A	90655	30MI CARBINE
SHELL PLATE #7B	90668	32 AUTO
SHELL PLATE #9	90656	41 MAGNUM
SHELL PLATE #11	90657	44 SPECIAL, 44 MAG, 45 COLT
SHELL PLATE #12	90666	7.62x39, PPC, 220 RUSSIAN
SHELL PLATE #13	90665	45 AUTO RIM
SHELL PLATE #14	90065	38/40, 44/40, 45 COLT
SHELL PLATE #19	90669	40 S&W, 10mm AUTO, 9mm LUGER 38 SUPER, 38 AUTO, 41 AE

If you order Shell Plates to convert to another caliber with a different primer size, be sure to order the Pro 1000 Primer Attachment.

Pro 1000 Primer Attachment 90660 10.00



Shell Plate Carrier 53.98

To change calibers, the entire Shell Plate Carrier can be replaced. Each unit comes complete with Shell Plate, Auto Prime, Case Ejector, Auto-Index and spare parts.

Carrier complete with Shell Plate and Primer Feeder

#1 Carrier	90644	38 SPL, 357 MAG, etc.
#2 Carrier	90645	45 ACP, etc.
#4 Carrier	90646	222, 223, 380 AUTO, 32S&W LONG, 32H&R MAG
#7A Carrier	90648	30 MI CARBINE
#9 Carrier	90649	41 MAGNUM
#11 Carrier	90650	44 SPECIAL, 44 MAGNUM, 45 COLT
#19 Carrier	90683	40S&W, 9mm LUGER, 38 SUPER, 38 AUTO, 41AE
#19L Carrier	90662	10mm AUTO



Turret 90497 10.98

ACCESSORIES FOR PRO 1000 and LOAD MASTER PRESSES

Case Feeder

LARGE CASE FEEDER 90658 25.00
38 SPECIAL • 357 MAGNUM • 41 MAGNUM
44 SPECIAL • 44 MAGNUM • 45 ACP
45 COLT • 10mm AUTO • 7.62x39 RUSSIAN
40 S&W uses the Large Case Feeder with a small slider.

SMALL CASE FEEDER 90659 25.00
9mm LUGER • 380 AUTO • 32 AUTO
32 S&W LONG • 32 H&R MAGNUM • 38 AUTO
38 SUPER

RIFLE CASE FEEDER 90663 25.00
222 • 223 • 30 M1

Extra Case Feeder Tubes 90661 7.98
(7 PACK)



Adjustable Charge Bar

90792 9.98
see page 20

Case Collator

Fills all four tubes in just ten seconds. For the Pro1000 or Load-Master
90667 14.98



Bullet Feed Kit

The bullet feeder designed to directly fit the Pro1000 and Load-Master. Automatically feeds bullets into the mouth of the seating die. Aligns bullets more accurately than possible by hand. Increases the cyclic rate 50 to 100%. Order from chart at right.

29.98

FINEST RELOADER MADE

Lee Load-Master

- A massive press with advanced features. Ram is 1 1/4 inches in diameter. Stroke and clearance sufficient for largest magnum rifle cases.
- Load rifle and pistol rounds with equal ease.
- Load progressively or singly without spilled powder or components.
- Five stations so you can factory crimp and post size.
- Accepts all popular brands of dies (7/8 x 14)
- Automatic indexing with a wedge lock mechanism that will actually hold a ton.
- Positive and foolproof priming system that is easy and fast to fill.
- Removable turrets. Change calibers in seconds.
- Automatic 4 tube case feeder (pistol calibers)
- Loaded round ejector and case catcher.
- Quick change shell plate. No tools required.
- Grease and oil fittings along with hard chrome plated ram insure a lifetime of service for even the commercial reloader.
- Easy to empty primer catcher guaranteed to catch every primer.

This press will convince you that Lee is the quality leader. Every part of this tool was designed to be strong, long lasting, rust-resistant and user friendly. This machine is designed for a life-time of the hardest use.



Precision 5-Hole Turret with 20 locking lugs takes just seconds to change.
5 Hole Turret 90079 14.98



Shell Plate 29.98

#1s	90907	38 Spl, 357 Mag., etc.
#2L	90908	45 ACP, 30/06, 308, etc.
#3L	90909	30/30, 7x30 Waters, etc.
#4s	90910	223,222, etc.
#4A	90059	32 S&W Long, 32 H&R Mag., etc.
#5L	90911	Belted Magnums 300 Mag, etc.
#5A	90085	303 British & 30/40 Krag
#6s	90912	32/20, 25/20 etc.
#7s	90884	22 Hornet
#7a	90913	30 M1 Carbine, 32 ACP
#8L	90914	45/70, 348 Win.
#9L	90915	41 Magnum
#10L	90916	220 Swift, 6.5 Jap.
#11L	90917	44 Mag., 44 Spl., 45 Colt
#12L	90918	7.62x39, 6mm PPC, 22 PPC, etc.
#14L	90919	44/40, 38/40, 45 Colt
#19s	90920	9mm Luger, 40 S&W, 38 Super, etc.
#19L	90068	10mm Auto

Check shell holder chart on page 24 for further listings.



Loaded Round Catcher

Explosion Shield 90363 5.00

Necessary if using primers other than CCI or Winchester brand

PISTOL CALIBERS are equipped with Carbide dies, Pro Auto-Disk Powder Measure and a case feeder \$330.00

32 S&W Long • 32 H&R Magnum	90935
9mm Luger	90936
380 Auto	90937
38 Spec (will load 357 Mag.)	90938
357 Magnum	90939
40 S&W	90940
10mm Auto	90941
44 Spec. (will load 44 Mag)	90943
44 Magnum	90944
45 ACP	90945
45 Colt (will load 454 Casull)	90946

RIFLE CALIBERS are equipped with Lee Pace-Setter dies, Perfect Powder Measure, Universal Charge Die and case inserter (no case feeder) \$320.00

223 Remington	90922
270 Winchester	90926
308 Winchester	90930
30/06	90931

Special sizes can be made with any die set listed in this catalog for the same prices listed above.

Large Primer Feeder	90077 24.98
Small Primer Feeder	90075 24.98

The Bullet feed kit is complete for one bullet diameter and range of length. To convert to another caliber or bullet length select appropriate Feed die and finger.

29.98 Feed kits complete	Description	14.98 Feed die and fingers
90892	30 & 32 cal Bullets up to .60 long	90885
90893	9mm through .365 diameter up to .46 long	90886
90894	9mm through .365 diameter .46 to .60 long	90887
90895	9mm through .365 diameter .60 to .75 long	90888
90896	40 cal through .44 cal up to .65 long	90889
90897	40 cal through .44 cal .65 to .80 long	90890
90898	45 cal bullets up to .67 long	90891

Multi-Tube Adapter for Bullet Feed Kit

Four tube magazine keeps Lee Bullet Feeder fed with a continuous supply of bullets. Quickly and easily installed. Includes large and small adapters, four large and small feed tubes and cylinder, plate assembly.

90280 25.00



CHARGE YOUR CASES

WHILE EXPANDING THE CASE MOUTH

Do it automatically with the Lee Auto-Disk Powder Measures.

No other brand of dies offers this exclusive feature!

Lee Auto-Disk Powder Measure

Auto-Disk Powder Measures automatically dispense charges more uniformly than any other powder measure. The case itself actuates the measure as the neck is being flared. The measure is actuated during the presses maximum mechanical advantage. This assures the smooth, even action of the measure. Built-in baffle and precisely molded, glass reinforced charge disks contribute to the unmatched charge uniformity.

Lee Auto-Disk Powder Measure includes all four disks

90578 27.98



Lee Pro Auto-Disk Powder Measure

Commercial reloaders or competitive shooters first choice! Elastomer wiper and teflon coated metal casting make this the smoothest operating measure. Will not cut powder and almost totally eliminates leakage. Large hopper with shut-off valve is attached with brass thumb nuts for the ultimate in disk changing convenience. Increased safety with positive pull-back lever. Includes swivel adapter and spring return lever with spring.

Lee Pro Auto-Disk Powder Measure with all four disks

90429 45.00



Auto-Disk Riser

Installs between the Lee Powder through Expanding Die and Auto-Disk Powder Measure. Allows convenient use of other brands of dies that have extended adjusting screws and provides clearance for the Lee Safety Prime.

Auto Disk Riser 90041 9.98



Lee Rifle Charging Die

Die is used to charge small capacity rifle cases using the Auto-Disk Powder Measure. It works the same as the pistol powder through expanding dies except it doesn't expand the case mouth. Rifle case expansion is normally done in the sizing die.

Lee Rifle Charging Die 90194 11.98



Only Lee Dies permit charging the case while expanding the case mouth.

Auto-Disk Pull Back Lever

For progressive reloading. Eliminates possibility of powder binding while reducing the chance of missed or double charges caused by operator error.

Pull Back Lever & Chain

90479 2.98

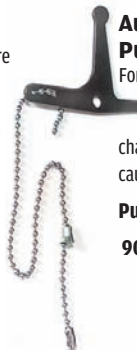

Pro Auto-Disk Update Kit

Update any Lee Auto-Disk Powder Measure with all the PRO features, except for the teflon coating. Includes oversize hopper and valve assembly with elastomer wiper, swivel adapter assembly for fast and easy transfer between die sets, pullback lever, chain and attachments, solid brass knurled thumb nuts.

With FREE Adjustable Charge Bar

Lee Pro Auto-Disk Update Kit 90377 19.98



Double Disk Kit (not pictured)

This kit raises the hopper so you can stack two disks. This not only doubles the capacity of the disks but it makes very fine adjustments possible. Most powders can be adjusted up or down .1 grain with different combinations of disks. Complete listing of combinations, 4 extra disks, screws and risers are included.

Lee Double Disk Kit 90195 14.98

Every one of these measures comes with a complete set of four disks. Each disk has six cavities so you get 24 cavities in all. The chart included on the rear of the instruction sheet lists the capacity of each cavity with every type of powder. If you reduce your charge 10% you can safely use this data without weighing your charge. Fixed cavities are the safest way to meter powder because they can't be misadjusted or get out of adjustment.



Adjustable Charge Bar

Infinitely adjustable between .28 and 1.6 cc. Lifetime nylon with solid brass, zero backlash micrometer. Easy to set.

Lee Adjustable Charge Bar 90792 9.98



Micro Disk

Accurately measures small charges below the range of the standard Auto-Disk Powder Measure. Six cavities range from 1.1 to 2.5 grains of Bullseye. This is an ideal kit for small caliber cases and light target loads.

Micro Disk and Spacer 90302 9.98



Swivel Adapter

For fast and easy transfer between die sets. Screws into your die without rotating the measure. Allows precise positioning with firm clamping.

Swivel Adapter 90477 5.98

NOTE The Auto-Disk powder measures must be used with the powder through expanding die supplied with all Lee pistol dies. These dies may be purchased individually. See listing of sizes on page 7.

Lee Perfect Powder Measure solves all of these problems

Eliminates Cut Powder and Jerky Action A soft elastomer wiper strikes off the metering chamber rather than cut the powder. You'll be surprised at how smoothly the rotor operates. More importantly, you will enjoy the most uniform of charges.

Stops Drum Binding A nylon cone shaped drum adjusted to zero clearance. The more it's used, the more perfect the fit becomes. The nylon is self-lubricating, so it will never bind or wear out.

Meaningful Calibration A micrometer adjuster that reads directly in cubic centimeters. Just multiply the charge in grains by the cc for one grain and you have the setting. So very much better than a meaningless setting as most others supply.

Safer "O" ring positively locks the adjustment and removes all end play.

Versatile The metering chamber is the proper size for large rifle charges and the strike off opening small enough to work well with pistol size chargewo over 100 grains.

Changing Powder is Fast and Easy Rotate the hopper 1/4 turn to shut off the powder flow and the hopper can be lifted off. You can empty the hopper from either end. The valve is also a powder baffle which contributes to the unusual accuracy of this measure.

Stops Powder Bridging Tapered drop tube quickly passes the powder without bridging.

Automation Optional Universal Charging Die makes the case operate the measure. Includes adapters to fits almost all cartridges.

Bargain! The very best measure ever made

Lee Perfect Powder Measure 90058 29.98



FREE sturdy steel stand included with each measure

Almost as good as a scale!

We didn't invent the drum type measure – we perfected it! This measure is unique, because it solves all of the problems common to ordinary drum type measures.

It is a pleasure to use, not only because it is the smoothest operating measure ever made, but you have the confidence that your charges will be the most uniform possible.

Lee Universal Charging Die

Automatically charges most cases. The die includes the connecting rod and adaptors to actuate the measure with the case. The measure is positively reset for the next charge when the press ram is fully lowered. Also included are drop tubes for most rifle and pistol cartridges from the 380 ACP to the 300 Win. Magnum. This die does not expand the case neck.

90273 24.98



Lee Safety Scale

Magnetically Damped and Approach To Weight



Safety and accuracy are the most important features.

Calibrated with weights certified traceable to the United States Bureau of Standards

This is the only scale that can never get out of adjustment. The beam is made from a very tough phenolic, the same type material used on table and counter tops. Phenolic is tough but, like glass, it can't be bent. Even if dropped you can feel confident that if it did not break it is still accurate. Sensitive and readable to 1/20 grain. **Lee Safety Powder Scale 90681 29.98**



Powder Funnel

A large, unbreakable funnel that fits all cases from .22 to .45 caliber. Hole in flange permits mounting to the Lee Turret Press, shelf or bench.

Powder Funnel 90190 2.98

Lee Powder Measure Kit

Fifteen uniformly graduated and proportioned powder dippers. Slide card shows the grains of powder each measure will dispense of every type of powder. Powder measures are inherently safe as they cannot get out of adjustment. That's why powder dippers continue to be the first choice of reloaders who load in small quantities.

Lee Powder Measure Kit 90100 9.98

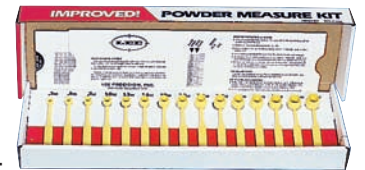

READ THIS if you already have a combination bullet and powder scale

Try this simple test to see how sensitive your scale really is. Cut a piece of regular writing paper or this catalog 5/16 inch square. With scale set on zero drop the paper on the pan to see if it moves. It should read about .1 grain. Keep adding paper squares until it does move. The total number of squares needed to move your scale is your scale's sensitivity. We have seen digital powder scales that are only sensitive to 1/2 grain (FIVE paper squares!). A Lee Safety Scale will move with the first paper.

Lee Case Trimmer

After a case has been loaded a few times, it will stretch beyond maximum length and must be trimmed. The Cutter and Lock Stud works for all calibers. You will need only one. The Case Length Gauge (Pilot) and Shell Holder must be ordered as Case Length Gauge and Shell Holder for each caliber. (See size listing at right). Trims cases by hand or use with an electric drill to trim, chamfer and polish cases faster. Eliminates danger of long cases. Squares the mouth for more accurate bullet seating and exit.

You need only one Cutter and Lock Stud for all sets

CUTTER and LOCK STUD 90110 5.98

LARGE CUTTER & LOCK STUD 90401 9.98

For .475 and larger cases. Can be used on any case.

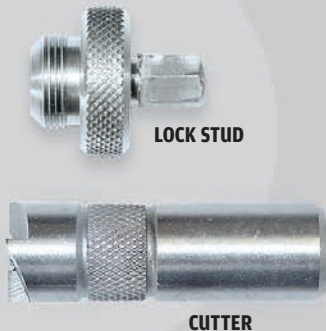

LOCK STUD

CUTTER

For safety sake,
trim your cases.



The simplest way to check the case and trim to the correct safe length is with a LEE CASE TRIMMER.



CUTTER only with BALL GRIP 90275 5.98

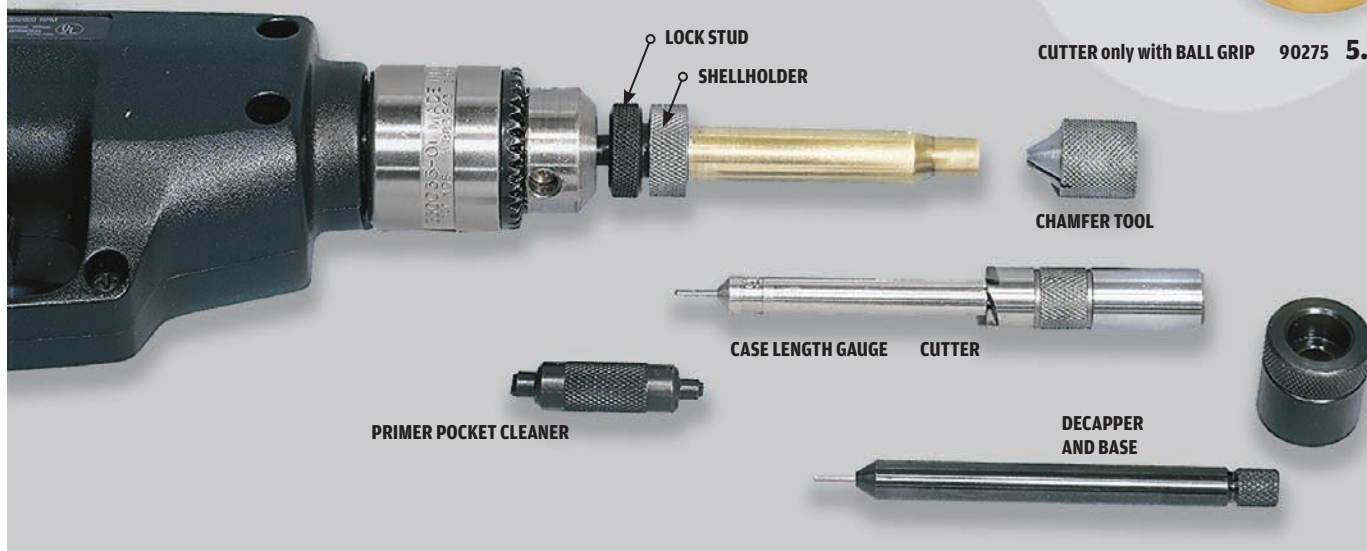

LOCK STUD
SHELLHOLDER

CHAMFER TOOL

CASE LENGTH GAUGE CUTTER

PRIMER POCKET CLEANER

DECAPPER
AND BASE

Chamfer Tool Must be used after Case Trimming. Unique design cuts fast without chatter. One turn does the job. Chamfers and deburrs inside and outside of case necks. Can also be used to remove the crimp from primer pockets of G.I. brass. Works better than tools costing several times as much.

LEE CHAMFER TOOL 90109 2.98

Decapper & Base Easily removes crimped in primers from military cases. Guaranteed unbreakable.

22 Caliber 90103 30 Caliber 90102 3.98

Primer Pocket Cleaner Double ended design cleans both large and small primer pockets. Primers can be fully seated for better accuracy and safety. Costs so little and works so well, no reloader can afford to be without one.

LEE PRIMER POCKET CLEANER 90101 1.98



3 Jaw Chuck works with any case from 25 ACP to the largest belted magnums. Three hardened steel jaws gently center the case while the spindle locks the case head. Cases are installed and removed with a fraction of a turn. Use with Spinner Stud (90607) or Zip Trim (90899)

LEE 3 JAW CHUCK 90608 15.98

Case Spinner Stud Optional case spinner spindle with drill shank for use with the 3 Jaw Chuck, turns any electric drill into a high speed case polisher/lathe. Also works great to hold cases for neck turning or trimming.

CASE SPINNER STUD 90607 2.98



Decapping Die An absolute must for those who clean cases before reloading. Cases need not be clean nor lubed when using this die. Tough, almost unbreakable decapper easily removes crimped in primers. One size fits all.

LEE DECAPPING DIE 90292 10.98
REPLACEMENT DECAPPER 90783 2.00



Universal Case Expanding Die Gently flares the case mouth to accept cast bullets without shaving. Works great to prevent damaging the moly and low friction coatings found on today's high performance jacketed bullets. Includes neck plugs for .22 cal through .45 cal. Works on everything from the 22 Hornet to the largest Ultra Mag.

LEE UNIVERSAL CASE EXPANDING DIE 90798 12.98



SPECIFY CALIBER FROM LIST OF SIZES

22 Hornet	90111
221 Fireball	90112
222 Remington	90113
223 Remington	90114
223 WSSM	90673
22/250	90116
220 Swift	90118
243 Winchester	90119
243 WSSM	90389
6mm Remington (244 Rem.)	90120
25/20 W.C.F.	90121
250 Savage (250/3000)	90122
257 Roberts	90123
25/06 Remington	90124
6.5 Carcano	90043
6.5 x 55 Mauser	90126
260 Remington	90993
6.8 SPC	90189
270 Winchester	90128
270 Winchester Short Mag	90117
284 Winchester	90129
7 x 57 Mauser	90130
7mm/08	90167
7mm Express/280 Rem.	90166
7mm Remington Magnum	90131
7mm Winchester Short Mag	90314
7 x 64 Brenneke	90236
7.5 Swiss (Schmidt-Rubin)	90132
7.5 x 54 MAS	90051
7.62 x 39 Russian	90133
7.62 x 54 Russian	90147
7.65 Mauser (Belgian-Arg)	90134
30 M1 Carbine	90135
30/30 Winchester	90136
30/40 Krag	90137
300 Savage	90138
300 Winchester Short Mag	90034
308 Winchester	90139
30/06 Springfield	90140
300 H&H 300 Ultra Mag	90141
300 Winchester Magnum	90142
300 Weatherby Magnum	90143
303 British	90144
32/20 W.C.F.	90146
7.7 Japanese	90115
8 x 57 Mauser	90148
338 Winchester Magnum	90149
35 Remington	90150
35 Whelen	90972
375 Winchester	90165
375 H&H 375 Ultra Mag	90164
444 Marlin	90151
45/70 Government	90152
458 Winchester Magnum	90971
32 Smith & Wesson Long	90169
9mm Makarov	90684
9mm Luger	90153
380 Auto	90155
38 Smith&Wesson	90156
38 Special	90157
38-55	90994
357 Magnum	90158
40 S & W	90154
10mm Auto	90127
41 Magnum	90159
44/40	90168
44 Special	90160
44 Magnum	90161
45 ACP	90162
45 Colt	90163
454 Casull	90992
480 Ruger Requires Large Cutter	90018
500 S & W Requires Large Cutter	90019

Unlisted case length gauges can be custom-made for \$15. This service is available factory direct only if the case head fits an existing shell holder.

50 BMG Requires Large Cutter	90010	\$20.00
------------------------------	-------	---------

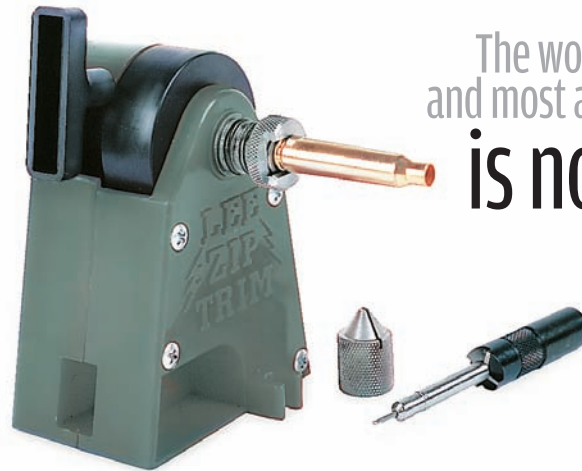

The world's most popular and most accurate case trimmer is now the fastest!

The Lee Zip Trim Power Head

There is no better system to check and trim cases than with the Lee case length gauge and cutter. You don't need an expensive caliper to set length and never waste even a single case setting up with the cut and try system common to all other brands. The piloted cutter assures the case mouths are absolutely square and true to the case neck. Best of all, the fixed length design assures it will never go out of adjustment. The Zip Trim rotates your case like a lathe. While your case is mounted, you can quickly trim, chamfer and polish your case.

The Zip Trim power head features a steel spindle that rotates in a housing made of tough nylon that will withstand chemical or mechanical attack –the same material being used in today's polymer framed firearms. The spindle is rotated by a recoil mechanism that puts over a 1/4 horsepower and 1,700 rpm at your fingertips – the spindle will start and stop instantly. Torque automatically decreases as the rpm increases at the end of the cut for a perfect feel and finish.

The head has two permanent mounting lugs and a socket to accept a "C" clamp for completely portable set-up. **Lee ZipTrim Power Head 90899 24.98**

includes mounting hardware
shown with Lee Case Trimmer and Chamfer Tool not included

Lee Universal 3 Jaw Chuck

fits the Lee Zip Trim and holds any case from the tiny 25 ACP to the monster 460 Weatherby. The hardened steel jaws gently and accurately center the case while the spindle securely clamps the case. Insert your case with a fraction of a turn.

90608 15.98

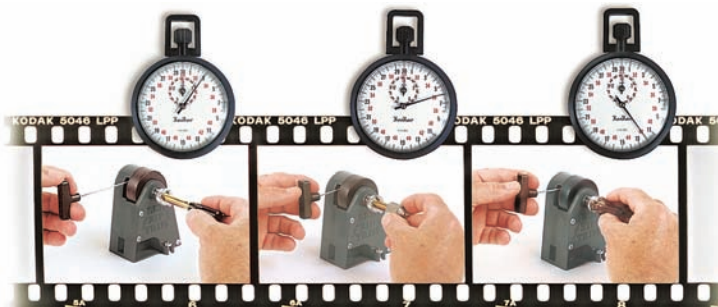

:03 Trim case using the Lee Case Trimmer

:03 Chamfer the case inside and out

:06 Polish case with steel wool or "scotch-brite"

Polishing the cases with steel wool or plastic scouring pad is so much faster than case tumbling. No time is required separating the cleaning media from cases, so no worry of the media sticking to the inside of your cases and no digging the media out of the flash hole.

:12 seconds to a finished case

Lee Auto-Prime II

Uses standard shell holders and will fit any brand of loading press with a vertical ram. Primes on upstroke for most sensitive feel. Includes primer feeders and punches for both large and small primers. Primer tray detaches for filling. Primers are flipped right side up by shaking the tray. Comes in a plastic storage box.

Lee Auto Prime II
90107 18.98



Lee Ram Prime

Primes on the press up-stroke for a more sensitive feel. Includes easy to change punches for both large and small primers. Fits all brands of presses. Same tool as supplied with the Challenger and Hand Press Kit. **Lee Ram Prime 90106 11.98**

Lee Auto Prime

Fastest, most accurate priming tool made. You never touch the primers from the box to the shell. Automatically feeds and installs primers just as fast as you can place shells in the holder. Each primer is perfectly seated with the feel appreciated by precision reloaders. Built-in primer flipper turns them right side up. Simply dump the primers into the tray, shake lightly, replace cover and you're ready to prime 100 shells. Uses low cost, easy to change shell holders. Includes both large and small trays. **Lee Auto-Prime 90230 16.98**



Depress tray to replace shell holder.



Easy to load; dump primers in tray, shake and replace cover.

WARNING Users have reported that the primers in the tray of an Auto Prime can explode for various reasons, some of which include: a cocked primer, or an attempt to prime a case which has a primer already in place, or more than one primer on the punch, or priming a military case with the crimp not completely removed. Should an explosion occur, our tests have demonstrated that safety glasses will normally prevent serious injury to the user if CCI or no more than twenty (20) Winchester primers are used, because the explosion is minimal. Other primers, however, can explode with sufficient force to seriously injure the user, or persons nearby. We do not take any position with respect to the quality or performance of primers available on the market. However, only those primers manufactured by CCI or Winchester are recommended for use in the Lee Auto Prime, and when loading those primers, safety glasses should always be used. No other primers should be used with the Lee Auto Prime.

Shell Holder Auto-Prime Improved Priming Tool For Presses & Auto-Prime II
2.98 3.98

#1	90201	90518
#2	90202	90519
#3	90203	90520
#4	90204	90521
#5	90205	90522
#6	90206	90523
#7	90207	90524
#8	90208	90525
#9	90209	90526
#10	90210	90527
#11	90211	90528
#12	90212	90529
#13	90213	90199
#14	90272	90001
#15	90017	90002
#16	90200	90003
#17	N/A	SD2827
#18	N/A	SD2980
#19	90023	90004
#20	90020	SD3590
#21	90031	SD3391

SHELL HOLDERS



Set of Shellholders

Eleven of the most popular sizes fit over 115 different cartridges. Chart (at right) is included with each shell holder set.

RED STORAGE BOX ONLY 90196 2.98

RED STORAGE BOX 90198 19.98

with 11 Shellholders for the Lee Auto Prime

GREEN STORAGE BOX 90197 22.98

with Universal Shellholders that work with all brands of presses

PACKED IN A LIFETIME PLASTIC BOX

NOTE: WHERE TWO NUMBERS ARE MARKED, THE FIRST NUMBER IS THE BETTER CHOICE.

HOLDER	RIFLE	HOLDER	RIFLE	HOLDER	RIFLE
4	17 Rem.	5	7mm Win 5 Mag	5	416 Rem.
4	204 Ruger	5	7mm Weatherby	8	416 Rigby
20 & 7	22 Hornet	5	7mm Ultra Mag	18	43 Mauser
20 & 7	22 K Hornet	2	284 Win.	17	43 Spanish
3	22 Savage	3	7.5mm Schmidt-Rubin	14	44/40
2	22 BR	7	30 M 1 Carbine	11	444 Marlin
6	218 Bee	3	7.65x53 Arg.-Mauser	8	45/70 Gov't
3	219 Zipper	12	7.62mm x 39	5	458 Win. Mag.
10	220 Swift	16	7.62x54 Russian		
4	221 Fireball	3	30 Herrett		
4	222 Rem.	3	30/30 Win. (30 W.C.F.)	1	22 Rem. Jet
4	222 Rem. Magnum	2	300 Savage	15	25 ACP
4	223 (5.56mm)	21	30 Remington	1	256 Win. Mag.
5	223 WSSM	2	308 Win. (.762 NATO)	19 & 6	30 Luger
2	224 Clark (22/257)	5	30/40 Krag (30 U.S.)	19 & 6	30 Mauser
10	225 Win.	2	30/06 Springfield	4	32 Short Colt
2	22/250	5	300 H & H	4	32 Long Colt
2	240 Weatherby	5	300 Weatherby	4	32 S & W
2	243 Win.	5	300 Win. Mag.	4	32 S & W Long
5	243 WSSM	5	300 Ultra Mag.	7B	32 ACP [Universal]
2	6mm Rem.	5	300 Win 5 Mag.	7	32 ACP [Auto-Prime]
2	244 Rem.	5	308 Norma Mag.	4	32 Colt N.P.
2	6mm Int'l	5	303 British	4	380 Auto
2	6mm/284	2	7.7 Jap.	19 & 6	9mm LUGER
2	6mm/06	3	32 Win. Spc'l	1	38 S & W
4	6 x 47 (6mm/222M)	3	32 Win. S.L.	1	38 Colt N.P.
2	25/284	6	32/20 (32 W.C.F.)	19 & 6	38 Super Auto
2	25/06	3	32/40 Win.	19 & 6	38 ACP
6	25/20 Win.	2	8 x 57 Mauser	1	38 Short Colt
2	250 Savage	2	8mm 06	1	38 Long Colt
3	25/35	2	8mm Man. Schoe.	1	38 Special
2	257 Roberts	5	8mm Rem. Mag.	1	357 Magnum
5	257 Weatherby	17	8mm Lebel	2	357 Auto Mag.
5	303/25	16	8x56R Hungarian	19	40 S&W
2	6.5mm 06	8	33 Win.	19	10mm AUTO
2	6.5mm x 57	5	338 Win. Mag.	1	41 Long Colt
3	6.5 x 55 Mauser	5	338 Ultra Mag.	19 & 6	41 Action Express
10	6.5 Jap	5	340 Weatherby	9	41 Magnum
5	6.5 Rem. Magnum	8	348 Win.	11	44 S & W Spc'l
2	6.5 Carcano	2	35 Rem.	11	44 S & W Russian
5	264 Win. Magnum	5	35 Win.	11	44 Magnum
21	6.8 SPC	2	35 Whelan	2	44 Auto Mag.
2	270 Win.	5	350 Rem. Mag.	2	45 Auto
5	270 Weatherby	3	356 Win.	11 & 14	45 Colt
5	270 Win 5 Magw	2	358 Win.	11	454 Casull
2	280 Rem.	5	358 Norma Mag.	5	455 Webley
2	7mm/08	3	375 Win.	12	PPC
2	7mm BR	5	375 H & H	13	45 Auto Rim
4	7mm TCU	5	375 Weatherby	2A	45 Win. Mag.
3	7 x 30 Waters	5	375 Ultra Mag.	5	480 Ruger
2	7 x 57mm Mauser	14	38/40 Win.	5	475 Linebaugh
5	7 x 61 Sharpe & Hart	3	38/55 Win.	16	500 S&W
5	7mm Rem. Magnum	8	40/82 Win.		



Lube & Sizing Kit

Fastest and easiest way to lubricate and size cast bullets. Standard 7/8 x 14 threads fit any reloading press. Bullets are pushed through the sizing die nose first, so no special nose punches are needed. Gas checks are automatically seated and crimped in place. Sized bullets are captured in the special container. A 4 oz. bottle of LEE LIQUID ALOX BULLET LUBE – a \$3.98 value – included free, is enough for thousands of bullets.

COMPLETE FOR ONE SIZE PRESS NOT INCLUDED 16.98

90049	.224	90686	.323	90062	.430
90036	.225	90934	.329	90061	.451
90083	.243	90046	.356	90055	.452
90170	.284	90047	.357	90056	.454
90171	.285	90048	.358	90057	.457
90037	.308	90060	.401	90191	.501
90038	.309	90052	.410	90188	.510
90039	.311	90053	.427		
90044	.314	90054	.429		

Other sizes can be made on a special order basis for \$25.00. Allow 3 weeks for delivery.

Universal Case Expanding Die

Gently flares the case mouth to accept cast bullets without shaving. Works great to prevent damaging the moly and low friction coatings found on today's high performance jacketed bullets. Includes neck plugs for .22 cal through .45 cal. Works on everything from the 22 Hornet to the largest Ultra Mag. Costs so little and works so well you can't afford to be without one.

LEE UNIVERSAL CASE EXPANDING DIE 90798 12.98



Hardness Testing Kit

Featured product in Chapter 10 of Modern Reloading. No more wasted components shooting too soft or too hard lead. Cast and load with confidence knowing your alloy is up to the job. Quickly and precisely check hardness of your lead alloy. Exclusive conversion chart tells the maximum operating pressure of any lead alloy.

LEE HARDNESS TESTING KIT 90924 58.00

KIT INCLUDES calibrated hardened steel ball indenter "v" block cradle snaps into standard press ram 20 power 4 lens optical measuring microscope



LUBRICATING BULLETS

Traditional bullet lubricating methods of placing lube only in the grooves are inferior to the modern method of coating the entire bullet with Lee Liquid Alox. This places the lube where needed, on the surfaces that rub against the bore.



Gently shake the bullets in an orbital motion to coat the bullets. If they do not coat completely, add a little more lube.



Spread the bullets onto waxed paper and let dry overnight.

Try this with your bullet lubricant!

The bullet melts while the Lee Liquid Alox clings tenaciously to the bullet.



Lee Liquid Alox

Lee Liquid Alox gives better accuracy because it eliminates leading. The lube coats the entire bullet like a thin jacket and dries to a soft, varnish-like finish that really clings. The dried coating does not degrade gunpowder. Easy to apply; eliminates the need for sizing of most cast bullets. While it works well with all cast or swaged bullets better than any other lube, it works best with micro band bullets, which are designed for tumble lubing. Marked with a TL on page 29.

LEE LIQUID ALOX 4 OZ. DISPENSER BOTTLE

Enough for thousands of bullets 90177 3.98

LEE NRA FORMULA ALOX BEESWAX MIX

Contains 50% Alox 2138F and 50% commercial A-1 Beeswax. Hollow stick fits most lubricators. Packed in handy plastic tubes.

ONE STICK 90007 5.98



Lee Pro 4-20

All the great features of the Pro 20 Pot, plus a generous 4 inches of clearance under the spout to accept all brands of bullet molds and most sinker molds. It also includes an adjustable mold guide to quickly and accurately position any mold for pouring.

Lee Pro 4-20 90947 110 Volt 89.98
Lee Pro 4-20 90948 220 Volt 94.98



Magnum Melter

Large 4" diameter pot allows easy access for the ladle caster. Same high efficiency design that has made Lee pots the most popular. Melt time is less than 20 minutes with just 700 watts. 20-lb. capacity for the longest casting session.

Magnum Melter 90949 69.98

Lee makes
bullet casting
easier

Lee Pro 20

Large diameter high capacity pot, holds approximately 20 pounds of lead. This second generation design incorporates the famous Lee patented high-efficiency design and dependable remote sensing thermostat, now in a dust tight housing. Long life 700-watt tubular heating element assures quick melting and rapid recovery. New micro adjustable, flow control valve adjusts instantly with a twist of the screw driver. Front mounted low maintenance replaceable valve spout allows instant reseating with a turn of a screwdriver.

Lee Pro 20 90950 110 Volt 79.98



WARNING Melting lead and casting lead objects will expose you and others in the area to lead, which is known to cause birth defects, other reproductive harm and cancer. See instructions on "Reducing Exposure" supplied with product.



New dust-tight housing extends thermostat life

Unique Infinite Heat Control

A highly reliable control, mounted away from the high heat of the pot. Eliminates failures usually associated with thermostatically controlled units. Thermal feed back to the infinite control permits heater to put out full power until the metal has melted.



A Lee Production Pot IV

Same as the Lee Production Pot (upper right), except that it features 4" of clearance under the spout instead of the standard 2". This is high enough to accept all brands of bullet molds and most sinker molds.

PRODUCTION POT IV	110 VOLT	90009	66.98
EXPORT MODEL	220 VOLT	90008	70.98

B Lee Production Pot

Large, deep pot holds approximately 10 pounds of lead. Melt time is less than 20 minutes. Pour spout up front where it belongs so you can see what you're doing. Infinite heat control. Uses only 500 watts of power during heat-up and a lot less to maintain temperature. Large, stable base for safety. Well suited for commercial casting, clubs, police departments, etc. This pot has features not found on more expensive melters. Guaranteed two years.

PRODUCTION POT	110 VOLT	90022	62.98
EXPORT MODEL	220 VOLT	90025	66.98

C Lee Ingot Mold

Use to cast 1/2 and one pound ingots. Perfect for remelting and alloying. Wood handles stay cool. Aluminum mold is lightweight and rustproof.

INGOT MOLD	90029	13.98
-------------------	--------------	--------------

D Lee Lead Ladle

A convenient size ladle for bullet casting. Works equally well for right and left handers. Handy for skimming and stirring metal.

LEAD LADLE	90026	3.98
-------------------	--------------	-------------

E Lee Precision Melter

High speed melter with an infinite heat control for the serious shooter. Easily handles 4-cavity molds. Takes less than 15 minutes to melt 4 pounds of metal. Same infinite heat control as used on the Production Pot. 500 watts AC only. Guaranteed 2 years.

PRECISION MELTER	110V	90021	39.98
EXPORT MODEL	220V	90024	43.98



- All Lee Mold Blocks are made from aluminum because of the exceptional molding qualities.
- The mold cavities are lathe bored for unmatched roundness and size control.
- Only Lee guarantees roundness of .001 or less.
- Most bullets from Lee molds can be used as cast without sizing.

Lee Single Cavity Molds

Price includes handles and sprue plate. **19.98**

Double Cavity Molds

All molds for pistol calibers are double cavity to speed casting. Handles and sprue plate are included. **24.98**

Hollow Base Molds

These are available in single cavity only. They all have self centering automatic core pins for the fastest possible molding. Handles and sprue plate included. **25.98**

Six Cavity Commercial Quality Molds

These are made for heavy duty volume production. The mold and blocks have steel bushing and alignment pins for lasting precision. Price includes a cam operated sprue plate to eliminate the pounding common to ordinary molds. The sprue plate is hard anodized and held down with wave washers at each end. No finer mold can be purchased at any price. Handles extra. **50.00**

Mold Handles

Precision steel mold handles fit not only the Lee Six Cavity blocks, but most other brands of one and two cavity molds. Priced low enough so you can have a set for every pair of blocks. Lee Mold Handles 90005 **17.98**

Shotgun Slug Molds See Page 31

MOLD NUMBER CODE

	C	309	180	R
	GAS CHECK	DIAMETER	WEIGHT IN GRAINS	POINT SHAPE
	TL	Micro Bands for Tumble Lubing with Lee Liquid Alox		WC Wad Cutter
				SWC SemiWad Cutter
				RF Round with Flat
				R 1 Ogive Radius
				2R 2 Ogive Radius
				TC Truncated Cone

Micro Band Bullets usually require no sizing

A great innovation possible only because of Lee Liquid Alox Lubricant. The bullet shank has many shallow grooves for maximum lubricant retention. They all have a bevel base just behind a solid driving band. A great way to make bullets in quantity with minimum time, effort and equipment. More accurate than ordinary cast bullets.



Designed for liquid tumble lubricating

Custom Molds

We can produce custom bullet molds within certain limits. The prices are the same as our standard molds, but there is a tooling and set-up charge of \$100.00. If you are interested in this service, please send a self-addressed stamped envelope for a design assistance sheet, which outlines the basic limitations of our manufacturing process.

WARNING Melting lead and casting lead objects will expose you and others in the area to lead, which is known to cause birth defects, other reproductive harm and cancer. See instructions on "Reducing Exposure" supplied with product.

Cast Minie Bullets as fast as Round Balls



Minie Bullet Mold

Automatic Core Pin Mold. Open the mold upside down to empty. Close it and you're ready to cast the next. The core pin automatically centers in the mold. Easily cast 200 per hour. A quality mold built to last as long as your rifle.

COMPLETE w/ HANDLES and AUTOMATIC CORE PIN 25.98

Original Style Minie Bullet

58 Caliber 575-500M 90481

An extremely popular, traditional size Minie bullet. Available in 58 caliber only. Certainly a must for authentic muzzle loading shooting.



Improved Minie, Traditional Design

45 Cal. .450-294M 90467
 45 Cal. oversize .454-298M 90469
 50 Cal. .500-360M 90472
 54 Cal. .533-410M 90473
 54 Cal. oversize .540-415M 90474
 58 cal. .575-472M 90476
 58 cal. oversize .578-478M 90478

Improved design is easier to cast and load. Usually more accurate; a wider variety of sizes.



Modern Minie, Target Design

50 Cal. .500-354M 90471
 58 Cal. .575-470M 90475

The most accurate of all Minies. Makes nice, clean holes in the target. The first choice for highest scores.



Round Ball Molds

Have tangential cut off which eliminates the objectional nib at the sprue.

SINGLE CAVITY WITH HANDLES 19.98

DOUBLE CAVITY WITH HANDLES 24.98

SIZE	SINGLE	DOUBLE	SIZE	SINGLE	DOUBLE	SIZE	SINGLE	DOUBLE	SIZE	SINGLE	DOUBLE
.308	90407		.380		90423	.451	90439	90440	.527		90453
.311	90408	90406	.390	90424		.454	90441	90442	.530	90454	90283
.319	90410		.395	90425		.457	90443	90444	.535	90455	90456
.330	90412		.433		90432	.490	90447	90448	.562		90460
.350	90415		.440	90435	90436	.495	90449	90450	.575		90461
.360	90418		.445	90437	90438	.498	90451		.600		90975*
.375	90419	90420				.500	90452		.690		90978*

*24.98

R·E·A·L BULLET for Muzzleloaders

RIFLING • ENGRAVED • AT • LOADING

A solid bullet that loads easily even after many firings because of its unique cleaning action. Will not tumble. A perfect hunting bullet with heavy loads. Easy to cast. Shoots accurately even in greatly oversize barrels.

SINGLE CAVITY WITH HANDLES 19.98

DOUBLE CAVITY WITH HANDLES 24.98



	Grains	Single	Double
45 Cal.	200	90390	90390
45 Cal.	250	90391	90392
50 Cal.	250	90393	90394
50 Cal.	320	90395	90396
54 Cal.	300	90397	90398
54 Cal.	380	90399	90400
58 Cal.	440	90403	90404

Combo Molds

45 CAL 200RB with Handles 90405 24.98

This double cavity mold will cast one 45 Cal. 200 R.E.A.L bullet and one .440 diameter Round Ball.

50 CAL 320RB with Handles 90488 24.98

This double cavity mold will cast one 50 Cal. 320 R.E.A.L bullet and one .490 diameter Round Ball.



Rifling-Engraved-At-Loading

The driving bands are large enough to adequately engage the rifling when pushed into the muzzle, and thin enough to easily engrave. They're strong enough to withstand maximum charges without stripping or gas cutting.

Unique Cleaning Action You can shoot all day without cleaning your rifle between shots! When inserted into the muzzle, tiny scraping edges are swagged forward on each driving band. These perfect fitting scrapers remove the fouling from the previous shot.

Easier, Faster To Load It's easy to load straight and true, easier and faster than a round ball with patch. Easily stabilized with very light charges, the R-E-A-L bullet also retains accuracy with maximum loads. Each band is generously tapered to the rear with an angle close to that of a lathe center, so as to center the bullet against the rifle bands. When pushed in, the bullet automatically centers in the bore.

More Accurate The bevel base of the R-E-A-L bullet contributes to greater accuracy. When the bullet exits the bore, the gas escapes equally around the perimeter of the base. The uniform bevel is resistant to nicks that would permit gas to escape prematurely and cause a jet effect on one side of the bullet.



Conical Bullet Mold for black powder revolvers

A super accurate bullet that is easy to load straight and true. Two lube grooves prevent flash ignition and lead fouling. More energy and far greater accuracy than round balls.

	19.98 Single	24.98 Double
36 Cal. 375-130-1R		90378
44 Cal. Rem. 450-200-1R	90381	90382
44 Ruger Old Army 456-220-1R	90383	90384

WARNING Melting lead and casting lead objects will expose you and others in the area to lead, which is known to cause birth defects, other reproductive harm and cancer. See instructions on "Reducing Exposure" supplied with product.

Load shotgun shells — steel or lead shot—to look and shoot like new.

Lee Load-All II

Lee Load-All II shotgun shells not only look better than those loaded on machines costing hundreds of dollars, but they usually have more uniform velocity and patterns. You can load just as fast as with any other brand of loader costing up to \$200.

Twenty-four shot and powder bushings are included free. The bushings alone can cost several dollars each from other manufacturers— and they're not as accurate as those made by Lee. Only Lee supplies molded bushings.

This is a time proven tool. There are hundreds of thousands in use world wide: in over twenty-six years we have yet to see one worn out. Written 2-year unconditional guarantee and a lifetime warranty.

Lee Load-All II	52.98
12 GAUGE	90011
16 GAUGE	90015
20 GAUGE	90012

Lee Adjustable Shot Dipper

Accurately measure lead, bismuth and steel. Telescoping cup adjustable from 7/8 to 1 7/8 oz. Calibrated for lead shot. Works perfect for large pellet sizes. With steel, simply count out pellets or weigh and set dipper accordingly.

ADJUSTABLE SHOT DIPPER	90973	3.98
-------------------------------	--------------	-------------

Safety Charge Bar with 24 Shot and Powder Bushings. Impossible to accidentally use the bar without bushings in place. Bushing size is visible from front of machine. Includes charge table showing extensive powder data.

Load-All Options

Primer Feed

For even faster and more convenient loading, you can add a primer feeder to the Load-All II. Primers are transferred directly from the box to the feeder. The natural motion of the press keeps them flowing down the trough to the priming station. A simple lift of the trough positions the primer on the priming post when needed.

PRIMER FEED	90069	9.98
--------------------	--------------	-------------

Update Kit with Primer Feed

If you have an older Load-All, it can easily be updated to the Load-All II with the Update Kit. This includes the new base, column, mounting screws, shell plates for 12, 16 and 20 gauge, instructions and primer feed.

UPDATE KIT	90073	25.98
-------------------	--------------	--------------

Conversion To Another Gauge

The Load-All II can be easily and economically converted to another gauge with the conversion kit. The entire die carrier is replaced so no adjustments are needed. The conversion kit includes the die carrier, steel sizer, wad guide, shell holder, load data and instructions.

CONVERSION KIT		19.98
12 GAUGE	90070	
16 GAUGE	90071	
20 GAUGE	90072	



Safety Charge Bar included Free of Charge

Load slugs for less than standard trap loads



Lee Slug Mold

Exclusive Drive Key positively rotates the slug in rifled barrels and eliminates the need for support wads or base fillers; assures positive and smooth discard of the sabot wad.

Load slugs for less than standard trap loads. The Lee DRIVE KEY (patent rights reserved) slug is loaded in standard trap hull with standard wad and conventional folded crimp. Slug loads are produced with any standard shot shell reloading press.

Lee Slug Mold features the exclusive drive key. The drive key positively rotates the slug in rifled shotgun barrels. The key doubles as a support rib allowing use of a standard trap wad—no need for a support wad or base filler. Sabot wad design outperforms rifled slugs in rifled slug barrels. Velocity and accuracy meet and exceed expensive factory loaded rifled slugs. Molds feature self centering automatic core pins for maximum speed and convenience. Mold is complete with sprue plate, handles and complete instructions with suggested loads. Best of all, they're priced at what others charge for handles alone!

Shotgun Slug Mold	1 oz.	12 ga.	90281	25.98
Shotgun Slug Mold	7/8 oz.	12 ga.	90282	25.98



Guaranteed more accurate than factory slugs or your money back.



Lee Shooters Cap

Deluxe 6-panel low profile washed cotton twill cap. Features a fabric reinforced sweat band and fabric strap with brass buckle. One size fits all. Embroidered Lee logo.

Red 90249 Charcoal 90192 14.00

THE LEE Guarantee

LEE RELOADING PRODUCTS are guaranteed not to wear out or break from normal use for two full years or they will be repaired or replaced at no charge if returned to the factory. Any Lee product of current manufacture, regardless of age or condition, will be reconditioned to new, including a new guarantee, if returned to the factory with payment equal to half the current retail price!



If not 100% satisfied with any Lee Product purchased from any supplier displaying the *Satisfaction Guaranteed* plaque, you may return it within 30 days for a full refund. Every Lee Reloading Tool is unconditionally guaranteed for two full years and has a limited lifetime guarantee!

Classic Cast, Load-Master, LeverPrimeSystem, Lee Loader, Load-AllIII, RGB, Speed Die, Factory Crimp, PaceSetter, Perfect Powder Measure, Safety Scale, Auto-Prime, Micro-Band, Drive Key, R-E-A-L and ZipTrim are trademarks of Lee Precision, Inc.

www.leeprecision.com

LEE

LEE PRECISION, INC. 4275 HIGHWAY U
HARTFORD WISCONSIN 53027 262-673-3075

PRINTED IN THE USA | 1105

Shooter Program for Windows



Don Dorn's Shooter Program is back! Still the easiest to use, with great new features such as a target generator and a library of on-screen loading manuals. Some charge as much for a target generator as we do for the entire program.

External Ballistic Calculators

Several great options to choose from including trajectory path, reduced load calculator, bullet energy, determining ballistic coefficients, sectional density, minimum twist and recoil calculations for both shot shell and metallic loads. Included are over 400 bullet statistics.

Firearm and reloading records

Easy to use format, tracks your personal firearm inventory and your loads and their results.

Cost Calculators

Dramatically shows how reloading can save you 60 to 80% over the cost of factory ammunition.

Target Generator

New target generator allows you to print any or all of six choices of targets on your printer.

On-Screen Reloading Manuals

View the latest load data from the finest ballistic labs in the world directly on your screen.

Minimum Requirements

Windows 95 or newer. 38 MB of hard disk space and CD-ROM drive

Lee Shooter Program for Windows 90480 19.98

LEE PRECISION, INC.
4275 HIGHWAY U
HARTFORD WISCONSIN 53027