



American Security Products Company



Product Catalog 2006

**Creating Customers
For a Lifetime**



AMERICAN SECURITY PRODUCTS COMPANY

A Guide to Safe Usage

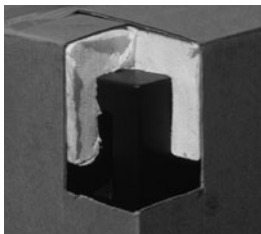
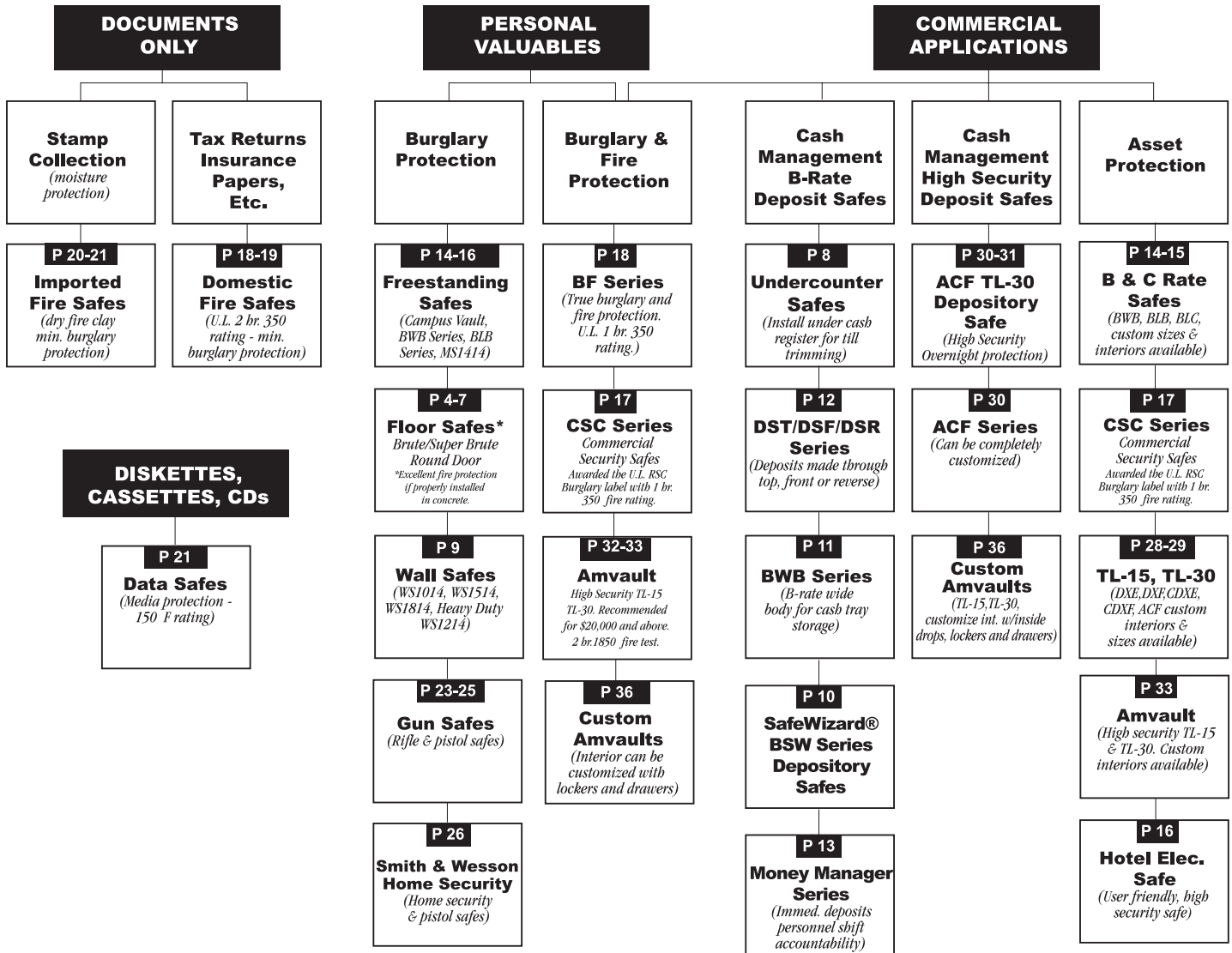

Optional UPS Packaging

- Overnight Reliable Shipments
- Reduced Freight Damage
- Reduced Freight Costs
- Quick Trackable Shipments

You can now offer overnight delivery of selected items to your customers. Our new UPS foam packaging is environmentally friendly and gives your UPS or RPS shipment the ultimate protection against freight damage.

Part No.	Model/Description
4505400	SuperBrute Floor Safes B1500, B2200, B2900
	MiniBrute Floor Safes B400, B700
	Depository Safe DST/DSF2014, DST/DSF2714
	Mini Safe MS1414
	STAR Tubular Body Floor Safes C3, etc., STAR Round Door only
	MAJOR Tubular Body Floor Safes T425, etc., MAJOR Round Door Only

AMERICAN SECURITY PRODUCTS COMPANY



Table of Contents

Square Door Floor Safes/RV Safe	
SUPER BRUTE, BRUTE, MINI-BRUTE & RV Safe	4
Floor Safes	
STAR, MAJOR Round Door Floor Safes	6
UnderCounter Safes	8
Wall Safes	9
SafeWizard® Depository Safes	10
Depository Safes	
Wide Body (BWB), Rotary, Front-loading (DS),	11
Money Manager II, “C” Rate Two Door Depository Safes	13
“B” & “C” Rate Freestanding Safes	
BWB, US2015, MS1414, MS1513D, BLB & BLC	14
Campus Vault	16
Hotel & Residential Electronic Safe	16
Commercial CSC Security Safes	17
BF™ Series	
U.L. listed fire rated burglary safes	18
U.L Fire Resistive Rating Classification	19
U.L Listed 2 Hour Fire/Impact Safes	19
Imported Fire Resistant Safes	
Residential, Commercial	20
Imported Data Safes - U.L. Fire Rated Classification	21
Electronic Solid Steel Safes & Cash Boxes	22
Gun Safes, Gun Cabinets	23
Smith & Wesson Home Security Safes / Handgun Safes	26
Gun Safes Accessories/Options	27
DXE/DXF and CDXE/CDXF	
TL-15, TL-30 Plate and Composite Body, Specification chart	28
ACF TL-30	
ACF Composite, ACF Double Door	30
Vault Door	31
AMVAULTS, TL-30, TL-15 Fire Rated Composite Safes	32
U.L. Burglary Rating Classification	33
Optional Extras	
Dials, modular alarm, bolt detent, coin racks, interiors, hoppers, doors	34
Teller Lockers, Custom Safes	36
ESL Electronic Locks	37
Access Manager Electronic Time Lock, SafeWizard® Access Control System	38
Sargent & Greenleaf COMPTRONIC™ Safe Locks, Mas-Hamilton AUDITCON® Lock Series	39
La Gard Electronic Safe Locks	40
Electronic Safe Lock Comparison Chart	41
Material Handling Equipment	42
Merchandising Displays	44
Index by Model Number	45

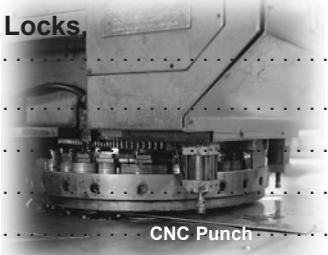
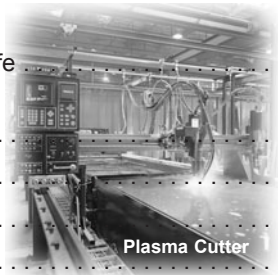

American Security Products Company has been dedicated to manufacturing high quality, high security safes since 1946. We offer an extensive product line of over 400 standard models of burglary and fire resistant safes in every insurance classification from “B” rate to Underwriter’s Laboratories TL-15 and TL-30.

AMSEC is the largest and most respected safe manufacturer in the industry because:

- Our dedicated customer service representatives care about you.
- Fully staffed service department networked with thousands of factory trained technicians.
- Our quality control department assures that the products we build are the finest in the industry.
- State-of-the-art computer controlled manufacturing equipment helps us meet demanding deadlines and keeps us on the leading edge of technology.
- We are located in a major West Coast distribution point with direct access to all major domestic and international freight services.
- We specialize in developing custom safes to meet specific cash handling requirements for banks, restaurants, supermarkets, convenience stores and many other industries.
- Our engineering and design department is fully staffed and features the most advanced CAD system for rapid creation of sales drawings, design modifications and precise manufacturing blue prints.

For superior asset protection there is only one name you can trust for quality, service and reliability...AMSEC.



AMERICAN SECURITY PRODUCTS COMPANY

Square Door Floor Safes SUPER BRUTE & BRUTE Series

All BRUTE Series safes are designed to provide secure storage for documents, jewelry, precious metals and miscellaneous valuables at an economical price. When properly installed in a concrete floor, BRUTE Series safes provide excellent fire and burglary protection. BRUTE floor safes meet and exceed the requirements of the Insurance Offices Manual of Burglary Insurance.

You may also add many options to customize your safe, such as: a drop slot in the door, depository chute, digital keypad lock and keylocking dial to name a few. BRUTE Series safes may be installed in the floor, wall, cladding, or within a larger safe.



SUPER BRUTE
Model B1500



Top view of
B1500 SUPER BRUTE



B3700

B1500

For Slotted Door
SeePage 35

SUPER BRUTE & BRUTE

Standard Features:

- Black textured body and door.
- Large brass plated dial and black matte finish dial ring with matching handle.
- 3M Lexan escutcheon plate covers the entire door surface.
- End user can get combination changes by just bringing the door to a locksmith.
- Attractive design offers strong reliable welds to protect against burglary attacks and reduce possible leakage.
- U.L. listed Group II key changeable lock, with relock and 1 million possible combinations.
- An additional spring loaded reloading device, activated by a punching attack.
- Lock and relocks are protected by a large carburized hardplate.
- A handle activated locking mechanism consisting of five 3/4" diameter locking bolts. Each one is drive resistant, chromed steel with a long throw.
- One piece heavy duty dead bar behind hinge prevents removal of door even if hinges are removed during a forced entry attempt.
- Door is designed to fit full body size, which greatly reduces any possible pry points.
- Doors are interchangeable within product group.

Body:

- Oversize floor plate ensures strong installation in concrete.
- Flush cover plate.
- Solid steel hinge mechanism using 3/8" diameter steel hinge pins and internal mounting bolts.

SUPER BRUTE

Additional Features:

- The SUPER BRUTE's new door jamb design is manufactured with state-of-the-art equipment, with built-in devices offering the ultimate protection against sledgehammer attack.
- "B+" rate door: 3/4" solid steel plate door is standard.
- Doors are removable and interchangeable.
- A large, convenient 10-3/4" x 11-1/8" door opening for bulky items.
- One sliding shelf with double wide model (B3700). Two sliding shelves with triple wide models (B5800).
- Attractive carpeted floor in every unit.

BRUTE Series

Additional Features:

- A large, convenient 11-3/4" x 16" door opening, for large bulky items or cash tray storage.
- B rate door: 1/2" solid steel plate door.

Super Brute Floor Safes Lifetime Replacement Warranty:

If your AMSEC Super Brute floor safe is subject of a sledgehammer or pry attack and is forcibly entered, AMSEC will replace or repair the safe (our option) with a current production model of comparable value - free of charge. The damaged safe must be returned freight prepaid to the factory within 30 days of the loss, accompanied by a properly filled police report. This warranty does not apply to damage or loss resulting from accident, alteration, unauthorized entry or improper installation. AMSEC's limited warranty policy and procedures applies to any extended product warranties.

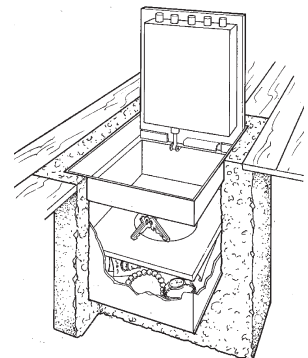

Double Compartment

AMERICAN SECURITY PRODUCTS COMPANY



MINI-BRUTE Square Body, Lift-Out Door, Floor Safe and Recreational Vehicle Safe

MINI BRUTE

Door:

- Black textured body and door.
- Large brass plated dial and black matte finish dial ring.
- 1/2" A36 solid steel plate. New steel guards protect lock and relock from accidental damage.
- U.L. listed Group II lock with relock. An additional relocking device, activated by punching attack.
- Heavy duty dead bar behind the hinge prevents removal of door even if the hinges are removed during forced entry attempt.
- Convenient, reversible lift-out door with a heavy duty handle.
- Optional baffled drop slot in door.

Body:

- One piece 8" square tubular "B" Rate construction.
- Universal jamb design allows the door to be positioned in all four directions.
- Continuous welded collar for added protection against pry attacks.
- A flush cover plate for total concealment under a carpet.

(RV411) RECREATIONAL VEHICLE SAFE

- 3/16" thick solid steel lift-out door, recessed for maximum protection against pry attacks.
- "B" Rate body construction with 1-1/4" flange for easy and attractive installations.
- 1/4" solid steel door jambs on all four sides for maximum protection against attacks.
- Door securely locked by a key operated camlock and two solid steel dead bars.
- Four anchor bolt holes, solid steel dust cover and two door handles are standard equipment.
- RV floor opening: 12-1/8" x 5-1/8".

BRUTE Series Wide Door



MINI BRUTES



RV Safe



Model	Inside H x W x D	Outside H x W x D	Door Opening	Cubic Inch Capacity	Wt. Lbs
SUPER BRUTE					
B1500	11 ⁷ / ₈ x 13 ¹ / ₄ x 8 ³ / ₄	12 ³ / ₄ x 14 ¹ / ₈ x 11 ³ / ₄	10 ³ / ₄ x 11 ¹ / ₈	1,377	100
B2200	11 ⁷ / ₈ x 13 ¹ / ₄ x 14	12 ³ / ₄ x 14 ¹ / ₈ x 17 ¹ / ₂	10 ³ / ₄ x 11 ¹ / ₈	2,203	120
B2900	11 ⁷ / ₈ x 13 ¹ / ₄ x 18 ¹ / ₄	12 ³ / ₄ x 14 ¹ / ₈ x 21 ³ / ₈	10 ³ / ₄ x 11 ¹ / ₈	2,872	130
B3800	12 ⁵ / ₈ x 18 x 17	12 ³ / ₄ x 18 ³ / ₄ x 21 ³ / ₈	10 ³ / ₄ x 11 ¹ / ₈	3,864	136
B2900D*	(top) 11 ⁷ / ₈ x 13 ¹ / ₄ x 9	12 ³ / ₄ x 14 ¹ / ₈ x 21 ³ / ₈	10 ³ / ₄ x 11 ¹ / ₈	1,416	138
	(bottom) 11 ⁷ / ₈ x 13 ¹ / ₄ x 8 ¹ / ₄		6 ³ / ₈ Dia.	1,298	
B3700	11 ³ / ₄ X 23 X 14	12 ³ / ₄ X 24 X 17 ¹ / ₂	10 ³ / ₄ X 11 ¹ / ₈	3,785	142
B5800	11 ³ / ₄ x 35 x 14	12 ³ / ₄ x 36 x 16 ³ / ₄	10 ³ / ₄ x 11 ¹ / ₈	5,758	182
BRUTE					
B1806	12 ¹ / ₄ x 18 ¹ / ₂ x 6	13 ¹ / ₄ x 19 ¹ / ₂ x 9	11 ³ / ₄ x 16	1,360	102
B1810	12 ¹ / ₈ x 18 ¹ / ₂ x 10	13 ¹ / ₄ x 19 ¹ / ₂ x 13	11 ³ / ₄ x 16	2,281	116
B1816	12 ¹ / ₄ x 18 ¹ / ₂ x 16	13 ¹ / ₄ x 19 ¹ / ₂ x 19	11 ³ / ₄ x 16	3,626	142
B1816D*	(top) 12 ¹ / ₄ x 18 ¹ / ₂ x 5 ³ / ₄	13 ¹ / ₄ x 19 ¹ / ₂ x 19	11 ³ / ₄ x 16	1,303	152
	(bottom) 12 ¹ / ₄ x 18 ¹ / ₂ x 10		6 ³ / ₈ Dia.	2,266	
MINI BRUTE / RV Safe					
B400	7 ⁵ / ₈ x 7 ⁵ / ₈ x 6 ³ / ₄	8 ¹ / ₂ x 8 ¹ / ₂ x 10 ¹ / ₈	6 ⁵ / ₈ x 7 ⁵ / ₈	393	32
B700	7 ⁵ / ₈ x 7 ⁵ / ₈ x 11 ³ / ₄	8 ¹ / ₂ x 8 ¹ / ₂ x 15 ¹ / ₈	6 ⁵ / ₈ x 7 ⁵ / ₈	683	42
RV411	4 ³ / ₄ x 11 ³ / ₄ x 10	7 ¹ / ₄ x 14 ¹ / ₄ x 12	3 ³ / ₄ x 10 ³ / ₄	558	22

*Double compartment - slotted inner door. See options for Slotted Door page 35.



STAR® Round Lift Out Door Floor Safes



Cut-away View of "C" Rate Lift-Out Door



STAR Floor safes are engineered with advanced security features. STAR Tube safes have been the standard for gas stations, fast food, small retail establishments and home owners for over 50 years.

Low cost, combined with the various body styles and optional doors will fit almost any cash handling system. When properly installed in concrete, STAR Floor safes provide maximum fire and burglary protection. Now, with the water resistant dust cover, you get protection from water as well.

"C" Rate Lift-Out Door Features:

- Manipulation resistant, unitized U.L. Group II key changeable lock protected by a revolving carburized hardplate.
- Removable dial and drive/drill resistant spindle preventing damage from burglary attack and additional protection from hold-up.
- Door, 7-1/4" clear opening, is 1-3/4" solid steel.
- Door is securely locked by three bolts each requiring over 25,000 pounds to shear.
- Each locking bolt has its own hardened steel positive relocking bolt.
- Body — Heavy "B" rate construction.

this type of safe. Available with dual key inner compartment. Manager holds one key, the armored car driver, or employee holds the second.

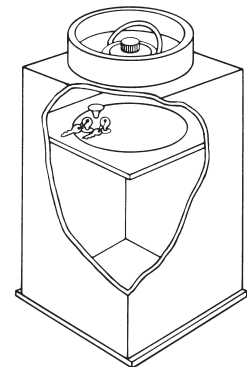

Exploded view of STAR double compartment.

Other Features:

- Water resistant, high impact molded dust cover with rubber "O"-ring seal does not rattle or slide like most covers.
- STAR's double compartment models provide the commercial user with the most effective cash handling system available. Hold-up as well as burglary protection is greatly enhanced by use of



Keylock with combination. Dual Control

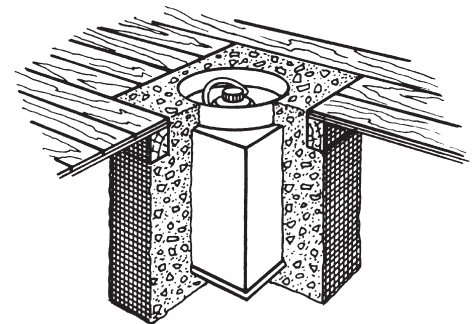

When properly installed in concrete, STAR Floor safes provide excellent fire and burglary protection. Now, with the water resistant dust cover, you get protection from water as well.



Keylock Door



Water Resistant Dust Cover

For Slotted "C" Door See Page 35

AMERICAN SECURITY PRODUCTS COMPANY

STAR Rectangular Body Round Lift-Out Door Floor Safes

STAR Rectangular Body, round lift-out door "B" rate floor safes offer a large cubic inch capacity at a reasonable price. Strong, continuously welded steel bodies are offered with our standard "C" rate lift-out combination door and a water resistant dust cover.

"C" Rate Lift-Out Door Features

- Utilizes the STAR high security "C" Rate door.

- Body — "B" Rate construction available in double compartment models (D) or outside drop chute (BDP).

Model No.	Inside Diameter x H	Outside Diameter x H	Door Opening	Cubic Inch Capacity	Wt. Lbs
Tubular Body Safes					
C3	8 ¹ / ₄ x 5 ³ / ₄	8 ³ / ₄ x 9	7 ¹ / ₄ Dia.	280	40
C5	8 ¹ / ₄ x 10	8 ³ / ₄ x 13 ¹ / ₂	7 ¹ / ₄ Dia.	510	46
C7	8 ¹ / ₄ x 16	8 ³ / ₄ x 19	7 ¹ / ₄ Dia.	785	55
CD5*	(top) 8 ¹ / ₄ x 4 ¹ / ₄ (bottom) 8 ¹ / ₄ x 4 ¹ / ₂	8 ³ / ₄ x 13 ¹ / ₂	7 ¹ / ₄ Dia.	225	54
CD7*	(top) 8 ¹ / ₄ x 5 ¹ / ₂ (bottom) 8 ¹ / ₄ x 9	8 ³ / ₄ x 19	7 ¹ / ₄ Dia.	175	66
"C" Rate Rectangular Body Safes					
B6	12 x 10 x 5 ¹ / ₄	12 ¹ / ₂ x 11 ¹ / ₄ x 9 ³ / ₄	7 ¹ / ₄ Dia.	630	62
B17	12 x 12 ¹ / ₂ x 10	13 x 13 x 15	7 ¹ / ₄ Dia.	1,500	98
B24	12 x 12 ¹ / ₂ x 14 ¹ / ₂	13 x 13 x 19	7 ¹ / ₄ Dia.	2,175	122
BD24**	(top) 12 x 12 ¹ / ₂ x 5 ¹ / ₂ (bottom) 12 x 12 ¹ / ₂ x 10	13 x 13 x 20	7 ¹ / ₄ Dia.	825	130
BDP24**	(top) 12 x 12 ¹ / ₂ x 4 ¹ / ₄ (bottom) 12 x 12 ¹ / ₂ x 13 ³ / ₄	13 x 13 x 22	7 ¹ / ₄ Dia.	638	142

*Double compartment, slotted inner door.

**Double compartment, solid inner door with outside drop chute.

MAJOR® Round Lift-Out Door Floor Safes

Major® MAJOR® Tubular Body, Round Lift-out Door Floor safes provide excellent fire and burglary protection when properly installed in concrete.

"C" Rate lift-out door Features:

- Unitized U.L. Group II key changeable lock with randomized opening positions defends against drill attacks.
- Drive resistant dial and spindle blocks sledgehammer attacks.
- Door, 6-5/8" clear opening, is 1" thick solid steel.
- Door is securely closed by three 5/8" drive resistant locking bolts.
- A positive relocking device jams locking mechanism in the event of a forced entry attempt.
- Recessed locking mechanism protected by a large carburized hardplate.
- Heavy duty "B" rate solid steel body with reinforced door jamb.
- Available in double compartment models (DD) with a key locking inner door.
- Inside slot to bottom compartment on all (DD) models.

Model No.	Inside Diameter x H	Outside Diameter x H	Door Opening	Cubic Inch Capacity	Wt. Lbs
T425	8 ¹ / ₄ x 5 ³ / ₄	8 ⁵ / ₈ x 8 ³ / ₄	6 ⁵ / ₈ Dia.	307	40
T625	8 ¹ / ₄ x 10 ¹ / ₄	8 ⁵ / ₈ x 13 ¹ / ₄	6 ⁵ / ₈ Dia.	545	46
T925	8 ¹ / ₄ x 15 ³ / ₄	8 ⁵ / ₈ x 18 ³ / ₄	6 ⁵ / ₈ Dia.	840	54
T625DD*	(top) 8 ¹ / ₄ x 4 ¹ / ₂ (bottom) 8 ¹ / ₄ x 5 ¹ / ₄	8 ⁵ / ₈ x 13 ¹ / ₄	6 ⁵ / ₈ Dia.	241	54
T925DD*	(top) 8 ¹ / ₄ x 7 ¹ / ₂ (bottom) 8 ¹ / ₄ x 7 ³ / ₄	8 ⁵ / ₈ x 18 ³ / ₄	6 ⁵ / ₈ Dia.	401	64

* Double Compartment, slotted inner partition - slot size 7/16" x 3 1/2"



"C" Rate Round Door Rectangular Body Floor Safes



Cut-away view of MAJOR® Door





AMERICAN SECURITY PRODUCTS COMPANY

Undercounter Safes

AMSEC's Undercounter safes limit excess cash register funds by providing instant protection for interim deposits of cash or checks via the anti-fish deposit slot. Securely positioning the safe next to the cash register limits exposed cash and reduces the threat of robbery and internal theft.

Adaptable for multi-unit installation use, ideal for gun control, staff use, athletic clubs, security areas and much more.

Features:

- Heavy gauge solid steel construction.
- Full width deposit slot over door equipped with an "anti-fish" saw tooth baffle to guard against pilferage or fishing.
- Heavy-duty piano hinges.
- Available in three models with eight different lock options to fit your specialized security requirements.
- Units can be bolted together utilizing bolt holes.
- Interchangeable doors allow flexible means of changing locking mechanisms without replacing the entire unit.
- Two anchor holes provided on all four sides.
- Attractive and durable powder coated black finish.

- S&G Group II key changeable combination lock offers 1 million possible combinations. (Lock option #6).
- Dual Medeco® U.L. listed high security single key camlocks offer dual custody type operation. Supplied with two keys per lock. (not shown). (Lock option #8).
- Optional custom key control systems designed to your security requirements:
 - 1) Master Keyed
 - 2) Keyed Alike
 - 3) Keyed Different

Options:

- Deposit envelopes.

Heavy Duty Series Model K1 and K2:

- 1/4" thick A36 solid steel plate hinged door.
- Full width slot over door.
- A saw tooth baffle guards against pilferage or fishing.
- Your choice of U.L. listed dual control keylock (K-2), a single key Medeco® lock (K-1), or a Chicago single key lock (K-1A).
- "B" Rate steel construction.
- May be installed vertically or horizontally.
- May be mounted on or under counter as space permits.
- Durable, impact resistant Charcoal Gray textured finish.

IMPORTANT:

AMSEC Undercounter safes are recommended for any operation that requires a non-returnable deposit. These safes are not meant for overnight storage of cash.

Lock Options:

- Chicago single key camlock equipped with two keys. (Lock option #1)
- Chicago 7 pin radial key camlock, equipped with 2 keys. (Lock option #1-T)
- Medeco® U.L. listed high security single key camlock supplied with two keys. Medeco's restricted keyways protect against unauthorized key duplication. (Lock option #2)
- S&G single key safe deposit lock supplied with two keys. (Lock option #3)
- Dual custody safe deposit key lock (two keys required to open safe). (Lock option #4)
- Best removable core key lock supplied with two opening keys and one control key. (Lock option #5). A removable core system lets you change the combination of any lock in seconds and can easily expand to include new facilities. Can be supplied with or without core. (Lock option #7, without core).



TB0610-2 In-use



TB0610-1T
Chicago 7 pin radial key camlock (lock option #1-T)



TB1210-6
with Group II
Combination Lock
(lock option #6)



TB0610-2 or
TB0612-2
Medeco® single
key camlock (Dual
key lock option #8
- not shown)



TB0610-7 (without
core) or TB0612-7
(with core)
Best removable
core key lock
(lock option #5
with core, lock
option #7 without
core)



TB0610-4 or
TB0612-4
Dual custody safe
deposit key lock
(lock option #4)



TB0610-1 or
TB0612-1
Chicago key
camlock (lock
option #1)



TB0610-3 or
TB0612-3
4113 safe deposit
key lock (lock
option #3)



K-1

K-2

Model No.	Inside H x W x D	Outside H x W x D	Door Opening	Cubic Inch Capacity	Wt. Lbs
TB0610(*)	5 ⁷ / ₁₆ x 5 ⁷ / ₁₆ x 8 ³ / ₁₆	6 x 6 x 10	5 ⁷ / ₁₆ x 5	289	8
TB0612(*)	5 ⁷ / ₁₆ x 5 ⁷ / ₁₆ x 10 ³ / ₁₆	6 x 6 x 12	5 ⁷ / ₁₆ x 5	359	8
TB1210(*)	11 ⁷ / ₁₆ x 5 ⁷ / ₁₆ x 8 ³ / ₁₆	12 x 6 x 10	5 ⁷ / ₁₆ x 5	585	10
K1/K2	5 ⁵ / ₁₆ x 5 ⁵ / ₁₆ x 10	6 x 6 x 12	3 ¹³ / ₁₆ x 5 ⁵ / ₁₆	316	18

(*) Insert number 1 through 8 to specify lock option.

AMERICAN SECURITY PRODUCTS COMPANY



Wall Safes

AMSEC Wall safes are designed to provide hidden protection for documents and miscellaneous valuables. Each wall safe is also designed for easy installation between 16 o/c wall studs with pre-drilled anchor holes and a built-in flange eliminating unnecessary replastering.

Heavy-Duty WS1214 Features:

- Same features as Super Brute Floor safes. Please see page 4.
- One removable shelf. Extra deep interior.

WS1014/WS1514 Features:

- U.L. listed Group II key changeable lock, with relock and 1 million possible combinations.
- Electronic lock optional, or Chicago single key camlock with 2 keys.
- Flat dial allows flush mounted installation.
- 3/16" thick solid steel door with dead bar.

NEW! WS1814 Features:

- AMSEC's 5BE electronic push button lock is fast and easy to use.
- Solid steel construction with a 3/16" pry-resist ant door offers burglary protection.
- Built-in enhanced LCD interior lighting is activated when door is opened.
- Desktop door design provides a convenient workstation.
- Comes standard with two storage shelves or one shelf with hanging file rack.
- Open Door Signaling feature provides a signal that notifies the user or a monitoring service that the safe is unlocked.
- Silent Signal Alarm feature allows the user to secretly signal a monitoring service that an intruder is in the home.
- Expandable interior provides easy installation between 16"o/c wall studs and enables depths of either 4", 5" or 6".

WES2113 Features:

- Heavy duty steel body, 1/4" solid steel door and flange.
- Extra spacious interior, while still offering the convenience of fitting between studs.
- Easy to use push button electronic lock offers solid protection with the accessibility of quick entry and easy-change combo.
- Standard key override, in case of lost combination.
- Dual live bolts ensure protection against pry attacks.

- Two removable shelves.
- Cream colored, durable powder coated finish.
- Packaged for UPS shipment.

When fire is a concern, there is no better wall safe than the WFS1310 or WES1310.

WFS1310 Features:

- 1 hour fire rating, insuring the inside temperature never exceeded 350° (paper chars at 450°).
- Extra deep interior, with a convenient pull-out tray.
- Three wheel combination lock with knob operated locking mechanism.
- Each safe is equipped with side locking bolt-work mechanism incorporating 2 large 1-1/8" rectangular steel locking bolts.
- Two 1-1/8" rectangular steel deadbolts, preventing door removal during a forced entry attempt.
- Impressive 5/8" thick door with attractive two-tone Sage finish.

WES1310 (with Electronic Lock) Features:

- Same outstanding features of the WFS1310 and comes equipped with an easy to operate 6 digit, easy change electronic keypad.



WS1214



WS1014

WS1514



WS1814



WES1310



WES2113

Model No.	Inside H x W x D	Outside H x W x D	Door Opening	Cubic Inch Capacity	Wt. Lbs	Interior Shelves
WS1014**	10 x 13 ³ / ₄ x 3 ¹ / ₂	12 ¹ / ₄ x 15 ³ / ₄ x 4	9 ⁵ / ₈ x 12 ³ / ₄	481	22	1
WS1514**	15 x 14 x 3 ¹ / ₂	16 ¹ / ₂ x 15 ¹ / ₂ x 4	14 x 13 ¹ / ₄	688	26	2
WS1814 (2x4)	15 ³ / ₈ x 13 ¹¹ / ₁₆ x 3 ⁵ / ₈	18 ⁷ / ₈ x 14 x 4	15 x 13 ¹ / ₄	651	32	2
(2x6 inst.)	15 ³ / ₈ x 13 ¹¹ / ₁₆ x 5 ⁵ / ₈	18 ⁷ / ₈ x 14 x 6	15 x 13 ¹ / ₄	1184	32	2
WS1214	12 x 13 ¹ / ₂ x 5 ¹ / ₂	12 ⁵ / ₈ x 14 ¹ / ₈ x 10	10 ³ / ₄ x 11 ¹ / ₈	891	86	2
WES2113	20 ⁵ / ₈ x 13 ³ / ₄ x 2 ⁷ / ₈	22 ¹ / ₈ x 15 ¹ / ₈ x 4	19 ³ / ₁₆ x 11 ³ / ₈	733	36	2
WFS1310*	13 ¹ / ₄ x 9 ¹ / ₈ x 9 ¹ / ₂	17 x 13 x 14 ⁵ / ₈	13 ¹ / ₄ x 9 ¹ / ₈	1,164	96	1tray
WES1310*	13 ¹ / ₄ x 9 ¹ / ₈ x 9 ¹ / ₂	17 x 13 x 14 ⁵ / ₈	13 ¹ / ₄ x 9 ¹ / ₈	1,164	96	1tray

* 350°F, one hour fire rated wall safe. ** Specify suffix - K = camlock



AMERICAN SECURITY PRODUCTS COMPANY

The SafeWizard® Depository Safes

The SafeWizard® electronic safe controller is a state-of-the-art electronic product for use in controlling and auditing access to safes. Designed to prevent burglaries and internal theft, the SafeWizard® controls and documents each access to the safe. Based on contemporary high speed processors, unique user friendly software techniques and ingenious application ideas, this system surpasses all other safe access control systems.



BSW3020



STANDARD BSW2020FL Shown w/SafeWizard® and optional Safeguard



Safeguard



Dallas Key



Door Sensor

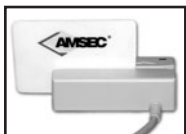

Card Swipe Reader



Fingerprint Reader

BSW Standard Features:

Door:

- Massive 1/2" thick solid steel plate with formed body and jamb for maximum protection.
- 3-way locking mechanism using five 1" chrome plated locking bolts with bolt detent that automatically engages boltwork.
- Lock protected by a carburized hardplate with auxiliary spring loaded relocker.

Interior Features:

- Heavy 1/4" steel door, with slam-bolt lock controlled by the SafeWizard® and a large clear door opening of 5 3/4" h x 12" w.
- Storage below locker I.D.
BSW2020/BSW3020: 10 1/2" x 19 3/4" x 14"
BSW2025/BSW3025: 10 1/2" x 24 3/4" x 14"
- Large "fish" resistant, pull out drop drawer accepts filled envelopes.

The SafeWizard® Features:

- A powerful processor based on the ColdFire® 32 bit microprocessor.
- Flash Memory for quick and cost effective upgrades.
- Up to 10,000 audit entries and 40 users.
- Controls up to 6 safe doors and 1 deposit lock. Safe doors can be configured in any inner-outer arrangement. Man Trap feature to maintain security in a safe room so the Entry Door and the Safe can't be opened at the same time.
- Time Delay any door with a 1-99 minute delay and 1-99 minute open period with cancel feature.
- Time Lock any door, 1-6 windows per day.
- Authentication options: PIN code and/or Dallas Key access control, optional Finger Print Reader or Card Swipe devices are available.
- Wrong Try Count Penalty Lockout.
- Auto-Purge Idle Users option, selectable by Individual User.
- Forced PIN Changes to decrease risk of compromised PINs.
- Armored Car courier Time Delay and Lock Bypass.
- Duress/Hold-up Alarm with Silent Signal.
- Burglary Alarm output triggering from selectable events.
- Holiday Schedule with up to 16 programmable events per year.
- Automatic Daylight Savings Adjustment, selectable and configurable.
- Dual Control Mode on any individual door, selectable by user.
- Built-in key maker, complete with management tool set, audit trail sorting by several criteria.
- Deposit Tracking system to provide the highest level of cash management security.
- Communications possibilities are unrivaled. Incorporating a built in Infra-Red (IR) Port, Multiple Serial Devices, optional Modem Communications Port and Ethernet Networking Port. Audits and administration can be managed through the Serial Port of Personal Computer or remotely via a Network and/or Modem connection.
- Audit trail can be downloaded to a Windows CE® based palmtop via the IR Port for compact and portable administration.
- Audit utility allows PC based audit storage management, data filter and sorting capabilities and excellent exception reporting to focus on key security issues.
- Ultra-high contrast 8 line by 21 character graphics display.
- Rechargeable Battery Backup.
- Built-in System Diagnostics.
- Alarm Interfaces in the Power Supply Module interfaces the system to any conventional Alarm System, with simple connections for Alarm Output, Duress Output, CCTV Activation and an Input for Alarm System control of the SafeWizard system.
- Parallel Printer Interface.
- English and Spanish language options.

Model No.	Inside Dimension H x W x D	Outside Dim. H x W x D	Clear Door Safe Only	Cubic Inch Capacity	Wt. Lbs	Interior Shelves
BSW2020	Locker: 6 1/8 x 19 3/4 x 13 1/2 Storage: 9 1/8 x 19 3/4 x 17	22 x 20 x 20	14 3/4 x 16 1/4	1,633 3,022	190	1
BSW3020	Locker: 6 1/8 x 19 3/4 x 13 1/2 Storage: 19 1/8 x 19 3/4 x 17	32 x 20 x 20	24 3/4 x 16 1/4	1,633 6,380	250	2
BSW4020	Locker: 6 1/8 x 19 3/4 x 13 1/2 Storage: 29 1/8 x 19 3/4 x 17	42 x 20 x 20	34 3/4 x 16 1/4	1,633 9,737	310	3
BSW2025	Locker: 6 1/8 x 24 3/4 x 18 1/2 Storage: 9 1/8 x 24 3/4 x 22	22 x 25 x 25	14 3/4 x 21 1/4	2,804 4,900	240	1
BSW3025	Locker: 6 1/8 x 24 3/4 x 18 1/2 Storage: 19 1/8 x 24 3/4 x 22	32 x 25 x 25	24 3/4 x 21 1/4	2,804 10,345	320	2
BSW4025	Locker: 6 1/8 x 24 3/4 x 18 1/2 Storage: 29 1/8 x 24 3/4 x 22	42 x 25 x 25	34 3/4 x 21 1/4	2,804 15,790	400	3



Wide Body Cash Control Depository Safes

Extensive research and development went into the engineering of AMSEC's Wide Body, "B" Rate cash handling depository safes. Designed to offer complete cash management versatility with a wide selection of depository options such as a top, front or rear load depository, one to three deposit slots or a pull-out deposit drawer.

BWB Standard Body Features:

- **Door:** Massive 1/2" thick A36 solid steel plate.
- Formed high tensile steel body and jamb construction to maximize protection against pry attack.
- Reinforced internal jambs on all four sides to provide protection against sledgehammer attack.
- U.L. listed Group II, key changeable combination lock.
- 3-way locking mechanism consisting of five 1" diameter chromed steel locking bolts.
- Bolt detent system engages boltwork automatically.
- Locks and relocks protected by a large carburized hardplate.
- Auxiliary spring-loaded relocking devices.
- Convenient, door-mounted, recessed coin rack.

Interior Locker Features:

- Heavy 1/4" steel door, with Medeco® high security camlock.
- Large clear door opening: 6"H x 12"W.
- Inside Dimensions:
BWB2020 / BWB3020: 8⁵/₈" x 19³/₄" x 14"
BWB2025 / BWB3025: 8⁵/₈" x 24³/₄" x 19"
- **Note: Top or Front Load Depository - inside locker height restricted to 6".**

Deposit Drawer Features:

- Large "fish" resistant, pull out drop drawer deposits directly into standard interior locker. Drawer size: 1¹/₈ x 3¹/₂ x 7¹/₂
- Heavy duty steel sliding drawer.

Deposit Slot Features:

- Convenient 1/4" x 4⁷/₁₆" opening, equipped with a steel money pusher to maximize "fish" resistance.
- Cash bins are provided in interior locker of safes with two or three slots.

Top Load Depository Features:

- Large rotary style formed heavy duty steel hopper.
- Handle activated and designed for smooth money drop.
- Large package capacity: 6¹/₂" x 5" x 10" (maximum).

Front Load Depository Features:

- Recessed heavy duty 1/8" construction with 1/8" door.
- Protected by dual "anti-fish baffles."
- Large package capacity: 3¹/₂" x 9" x 11¹/₂" (maximum).
- May be ordered in any one of four directions. Specify front, reversed, right load or left load.

IMPORTANT: AMSEC Depository safes are recommended for any operation that requires a non-returnable deposit such as armored car companies, convenience stores, restaurants, etc. The top locker is not meant for overnight storage of cash or valuables.

Model No.	Inside H x W x D	Outside † H x W x D	Door Opening	Cubic Inch Capacity	Wt.* † Lbs	Interior Shelves
BWB2020	19 ³ / ₄ x 19 ³ / ₄ x 17	20 x 20 x 20	14 ³ / ₄ x 16 ¹ / ₄	6,631	170	1
BWB3020	29 ³ / ₄ x 19 ³ / ₄ x 17	30 x 20 x 20	24 ³ / ₄ x 16 ¹ / ₄	9,988	270	2
BWB2025	19 ³ / ₄ x 24 ³ / ₄ x 22	20 x 25 x 25	14 ³ / ₄ x 21 ¹ / ₄	12,500	250	1
BWB3025	29 ³ / ₄ x 24 ³ / ₄ x 22	30 x 25 x 25	24 ³ / ₄ x 21 ¹ / ₄	16,198	290	2
BWB4020	39 ³ / ₄ x 19 ³ / ₄ x 17	40 x 20 x 20	34 ³ / ₄ x 16 ¹ / ₄	13,346	340	3
BWB4025	39 ³ / ₄ x 24 ³ / ₄ x 22	40 x 25 x 25	34 ³ / ₄ x 21 ¹ / ₄	21,644	390	3

Specify: D1=Drawer, S1=One Slot, S2=Two Slots, S3=3 Slots.
Specify: TL=Top Load Depository or FL=Front Load Depository.

* Add 10 lbs. to weight for each additional slot.

† Add 8" to height for Top Load Depository and 9-3/4" for Front Load Depository.

Minus 10-3/4" H for clear I.D. with locker.

(Add 50 lbs. for Front Load Depository and 53 lbs. for the Top Load Depository.)



BWB3020-D1



BWB3025-FL



BWB3020-FL

Each unit comes equipped with an interior locker to accommodate deposits, a large interior for storage of cash trays, and a door-mounted, recessed coin rack.



AMERICAN SECURITY PRODUCTS COMPANY

“B” Rate Rotary and Front Loading Depository Safes



DSF2014
w/ ESL10 lock



DSF2714K



DSC2014KC



DSF3214CC

Reverse Hopper



DSR2014 with ESL-10



DST2731CC

AMSEC's DS series Depository safes are designed to provide immediate deposits and secure storage for cash, jewelry, and miscellaneous valuables. Deposits can be made through a locked door via a top-loading rotary hopper, a reverse hopper, or a front-loading deposit door.

FEATURES:

Body:

- Strong, formed "B" Rate construction made of A36 solid steel plate for improved security and appearance.
- Formed door jamb for increased resistance to sledgehammer attack.
- Four anchor bolt holes are standard.

Door: Model Number 2014, 2714 and 3214

- 1/2" thick A36 solid steel plate, recessed 1/2" to increase resistance to pry attack.
- U.L. Group II combo lock (C), U.L. listed dual nose keylock (K).
- Three 1" diameter chromed steel locking bolts.
- Bolt detent system engages boltwork automatically.
- Auxiliary spring-loaded relocking device.
- Lock and relock protected by large carburized hardplate.

ized hardplate.

(Additional features: Model #2731)

- (3) 1" bolts x 1/2" rectangular plated bolts.

Hopper:

- 2014/2714 are available w/ reverse hopper.
- Large package sizes: (Extra-large Rotary): 6-1/4"D x 5" W x 10-1/2"L (Front/Reverse Load): 4"D x 2"W x 9-3/4"L
- Recessed, heavy duty 3/16" construction (1/4" door).
- Protected by dual "anti-fish" baffles.

Additional Features: Wide Body Model (2731)

- Unique space-efficient, side-by-side design creates full depth depository and large storage compartment.
- Accepts cash trays up to 13" x 18".
- Optional coin rack available on storage compartment door.

IMPORTANT: AMSEC Depository safes are recommended for any operation that requires a non-returnable deposit such as armored car companies, convenience stores, restaurants, etc. These safes are not meant for overnight storage of cash or valuables.

Model No.†	Inside H x W x D	Outside H x W x D*	Door Opening	Cubic Inch Capacity	Wt. Lbs
DST2014	11 1/2 x 13 3/4 x 11	20 1/4 x 14 x 14	9 3/4 x 9 3/4	1,739	100
DSF2014	10 x 13 3/4 x 11	20 1/4 x 14 x 14	9 3/4 x 9 3/4	1,513	94
DSR2014	10 x 13 3/4 x 11	20 1/4 x 14 x 14	9 3/4 x 9 3/4	1,513	94
DSC2014KC**	(bottom) 10 1/4 x 13 3/4 x 11 (top) 6 7/8 x 13 3/4 x 12 5/8	27 1/4 x 14 x 14	(bottom) 9 3/4 x 9 3/4 (top) 6 x 10 3/8	1,513 1,127	118
DST2714	18 1/2 x 13 3/4 x 11	27 1/4 x 14 x 14	9 3/4 x 9 3/4	2,571	120
DSF2714	17 1/4 x 13 3/4 x 11	27 1/4 x 14 x 14	9 3/4 x 9 3/4	2,571	110
DSR2714	17 1/4 x 13 3/4 x 11	27 1/4 x 14 x 14	9 3/4 x 9 3/4	2,571	110
DST3214	(top) 12 1/4 x 13 3/4 x 11 (bottom) 11 1/4 x 13 3/4 x 11	32 1/4 x 14 x 14	9 3/4 x 9 3/4 9 3/4 x 9 3/4	1,664 1,890	152
DSF3214	(top) 11 1/4 x 13 3/4 x 11 (bottom) 12 1/2 x 13 3/4 x 11	32 1/4 x 14 x 14	9 3/4 x 9 3/4 9 3/4 x 9 3/4	1,437 1,890	144
DST2731	(left) 18 1/2 x 14 3/8 x 18 (right) 27 x 16 x 18	27 1/4 x 30 3/4 x 21	(left) 9 x 9 7/8 (right) 22 1/2 x 14 3/8	4,787 7,776	285
DSF2731	(left) 16 3/4 x 14 3/8 x 18 (right) 27 x 16 x 18	27 1/4 x 30 3/4 x 21	(left) 9 x 9 7/8 (right) 22 1/2 x 14 3/8	4,399 7,776	276

* Add 2" to outside depth for dial and handle projection.

†Specify Prefix: T=Top loading, F= Front loading, R=Reverse hopper.

Suffix: K=Keylock C=Combo lock.

** K=Camlock

AMERICAN SECURITY PRODUCTS COMPANY

“C” Rated Double Door and Money Manager Depository Safes

AMSEC’s “C” Rate CDS3017 and “B” Rate Money Manager Series under-counter Double Door Depository safes are recommended for any operation that requires a nonreturnable deposit such as armored car companies, convenience stores, restaurants, etc. The secured deposit and receiving compartments protect against mysterious disappearance and pilferage.

Standard Features: CDS3017

- 1"- "C" Rate recessed pry-resistant solid steel doors.
- Handle activated locking mechanism consisting of five 3/4" diameter locking bolts on each door.
- U.L. Listed Group II key changeable combination locks.
- Auxiliary spring-loaded reloading device, activated by a punch attack.
- Locks and relocks are protected by a large carburized hardplate.
- One piece formed door jamb construction protects against sledgehammer attacks.
- Solid steel full length dead bar prevents door removal during a forced entry attempt.
- Optional auxiliary key locks available for dual control.
- 2" thick "C" Rate composite body.
- Concealed anti-fish deposit chute located in top compartment deposits directly into lower unit.
- Deposit chute capacity: 1-3/4" x 6-1/2"
- Two anchor holes provided for secure installations.
- Black textured finish accented with a brass-plated dial and decorative emblems.

The AMSEC Money Manager Series is the most effective cash handling system available.



Engineered to help you achieve total cash control.

Money Manager MM2820 Features:

- Heavy duty construction with 1/2" solid steel doors.
- Both doors equipped with high security combinations and key locks, offering dual control.
- Handle activated locking mechanism consisting of three 1" diameter locking bolts.
- Bolt detent device automatically engages bolts when doors are closed.
- Auxiliary spring-loaded reloading device, activated by a punch attack.
- Locks and relocks are protected by a large carburized hardplate.
- Formed door jamb and full length dead bar.
- Coin racks are standard on inside of storage door.
- Fish resistant depository drops accept bulk items, drop envelopes or bags.
- Cash drawers and bulky items conveniently fit into both compartments.
- Four anchor bolts and anchor hardware included.
- Available as a "top drop," "center drop," or "three drop" model.
- MM2820 front load and center drop hopper measures 16-1/2"W x 2-1/2"H.
- Three individual color-coded 4" drops for shift control. Three deposit bins provided on "three drop" model.
- Attractive Black textured finish.
- Optional colors available upon request.

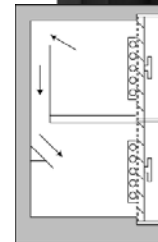

CDS3017



MM2820 Three Drop



MM2820 Center Drop

Model No.	Inside H x W x D	Outside H x W x D	Door Opening	Cubic Inch Capacity	Wt. Lbs.
CDS3017	(top) 11 7/8 x 13 1/4 x 12 1/8	30 x 17 1/2 x 19	10 3/4 x 11 1/8	1,908	590
	(bottom) 11 7/8 x 13 1/4 x 12 1/8			1,908	
MM2820 3-Drop	(top) 9 3/16 x 20 x 17	28 x 20 1/2 x 20	8 1/2 x 16 1/4	3,230	280
	(bottom) 11 3/16 x 20 x 17			3,740	
MM2820 Top-Drop	(top) 9 3/16 x 20 x 17	28 x 20 1/2 x 20	8 1/2 x 16 1/4	3,230	280
	(bottom) 11 3/16 x 20 x 17			3,740	
MM2820 Ctr-Drop	(top) 10 3/8 x 20 x 17	28 x 20 1/2 x 20	8 1/2 x 16 1/4	3,230	280
	(bottom) 10 3/8 x 20 x 17			3,740	



AMERICAN SECURITY PRODUCTS COMPANY

“B” Rate Security Safes

The many different features of the Wide Body safes, make them perfect for commercial application or home use.

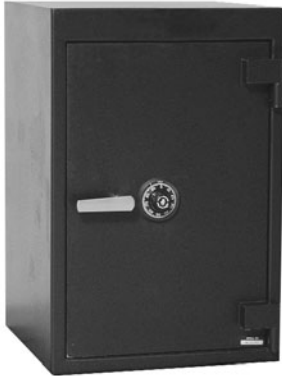

BWB3020

Standard Features for BWB and US2015C:

- 1/2" thick solid steel door, recessed for resistance to pry attacks.
- Formed, high-tensile steel body and jamb construction to maximize protection against pry attacks.
- U.L. listed Group II key changeable combination lock with over 1 million possible combinations.
- Auxiliary spring-loaded relock device.
- Locks and relocks protected by a large carburized hardplate.
- Attractive Black textured finish.

Additional US2015 Features:

- Five 3/4" diameter steel chromed locking bolts.
- Solid steel deadbar.
- Two adjustable shelves.
- Two anchor bolt holes.

Additional BWB Series Features:

- Reinforced internal jambs on all four sides to provide excellent protection against sledgehammer attack.
- 3-way locking mechanism consisting of five massive 1" diameter chromed steel locking bolts.
- Bolt detent system keeps bolts retracted when the door is open, then automatically engages when door is shut.
- Convenient door mounted recessed coin rack.
- Large capacity for storage of cash trays.
- Adjustable shelves.

Mini Safe (MS Series) Features:

- Strong, formed "B" Rate construction made of A36 solid steel plate for improved security and appearance.
 - Formed door jamb for increased resistance to sledgehammer attack.
 - 1/2" solid steel door.
 - U.L. Group II combo lock (C), U.L. listed dual nose keylock (K).
 - Three 1" diameter chromed steel locking bolts.
 - Bolt detent system engages boltwork automatically.
 - Auxiliary spring-loaded relocking device.
 - Lock and relock protected by large carburized hardplate.
 - Four anchor bolt holes are standard.
 - Adjustable shelf provided.
 - Also available as a "Mini-Deposit" safe with optional deposit slot or drawer.
- Drawer size: 1 1/8 x 3 1/2 x 7 1/2



US2015C



MS1513D
Mini Depository Safe



MS1414 with ESL10 lock

Model No.	Inside H x W x D	Outside H x W x D*	Door Opening	Cubic Inch Capacity	Wt. Lbs	Interiors/ Shelves
BWB2020	19 3/4 x 19 3/4 x 17	20 x 20 x 20	14 3/4 x 16 1/4	6,631	170	1
BWB3020	29 3/4 x 19 3/4 x 17	30 x 20 x 20	24 3/4 x 16 1/4	9,988	270	2
BWB3025	29 3/4 x 24 3/4 x 22	30 x 25 x 25	24 3/4 x 21 1/4	16,198	290	2
BWB4020	39 3/4 x 19 3/4 x 17	40 x 20 x 20	34 3/4 x 16 1/4	13,346	340	3
BWB4025	39 3/4 x 24 3/4 x 22	40 x 25 x 25	34 3/4 x 21 1/4	21,644	390	3
US2015	20 x 15 1/4 x 15	20 1/4 x 15 1/2 x 18	15 5/8 x 10 7/8	4,575	120	2
MS1414	13 3/4 x 13 3/4 x 11	14 x 14 x 14	9 3/4 x 9 3/4	2,080	61	1
MS1513D	14 3/4 x 12 3/4 x 14	15 x 13 x 17	9 3/4 x 9 3/4	2,633	61	1

* Add 2" to outside depth for handle, dial and hinge projection.



“B/C” Rate Security Chests

AMSEC “B” and “C” Rate security chests are designed to provide secure storage at an economical price. In addition to meeting the requirements of The Insurance Offices Manual of Burglary Insurance, these units offer an appearance and many features similar to AMSEC’s higher rated TL-15 models.

Standard Features:

Door:

- 1" (“C” Rate), or 1/2" (“B” Rate) steel pry-resistant recessed door.
- U.L. listed Group II key changeable lock, with relock and 1 million possible combinations.
- Additional spring loaded relocking device, activated by a punching attack.
- Locks and relocks protected by a large carburized hardplate.
- A handle activated locking mechanism consisting of three 1" chromed steel locking bolts. (five in BLB and BLC4024 models).

- Solid steel full length dead bar prevents door removal if hinges are removed during a forced entry attempt.
- Adjustable ball bearing hinges.

Body:

- 1/2" continuously welded (“C” rate) or 1/4" (“B” Rate) solid steel bodies.
- Body reinforcing frame gives the appearance of 1" thick walls to discourage attack.
- Adjustable shelves.
- Attractive Gray textured finish. Other colors available.
- Custom sizes, interior options and high security features available.
- Left swing door optional.



BLC3018

Model No.	Inside H x W x D	Outside* H x W x D	Door Opening	Cubic Inch Capacity	Wt. Lbs	Interior Shelves
“B” Rate						
BLB2018	20 x 18 x 12	20 1/2 x 18 1/2 x 15	18 x 16	4,320	200	2
BLB3018	30 x 18 x 16	30 1/2 x 18 1/2 x 19	28 x 16	8,640	300	2
BLB3024	30 x 24 x 20	30 1/2 x 24 1/2 x 23	28 x 22	14,400	360	3
BLB4024	40 x 24 x 20	40 1/2 x 24 1/2 x 23	38 x 22	19,200	445	4
“C” Rate						
BLC2018	20 x 18 x 12	21 x 19 x 16	18 1/2 x 16 1/2	4,320	370	2
BLC3018	30 x 18 x 16	31 x 19 x 20	28 1/2 x 16 1/2	8,640	550	2
BLC3024	30 x 24 x 20	31 x 25 x 24	28 1/2 x 22 1/2	14,400	740	3
BLC4024	40 x 24 x 20	41 x 25 x 24	38 1/2 x 22 1/2	19,200	925	4

*Add 2" to outside depth for handle, dial and hinge projection. Extra shelves optional.

MB1 - Mini Coin Bank

AMSEC’s popular Mini Coin Bank is 5 1/4" x 4 1/4" x 3 1/8" and comes in random assorted colors. Perfect as a promo item or for gifts!



MB1



AMERICAN SECURITY PRODUCTS COMPANY

Hotel & Residential Electronic Safe

AMSEC's new hotel and residential electronic safe, with it's easy installation, maintenance, and management features has become a popular safe in the hospitality industry. Designed with the traveling guest in mind, the HR916E will adequately secure laptop computers, cameras, jewelry, and other valuables, in the most user friendly safe made.



HR916E



HRC916E

Standard Features:

- Heavy duty steel construction offers excellent burglary protection.
- Convenient motorized locking system, incorporating the latest technology.
- Easy to read, large LED display let's you know the status of the safe.
- 4 digit combination, standard hotel room configuration (customer sets new combination every time safe is used, quickly and easily), or electronic credit card.
- Reliable ADA approved keypad.
- Electronic override can be set by security personnel.
- Runs on 4 AA batteries. If batteries should go dead, each safe has a by-pass power cable (9v battery required).

- Lock-out penalty if the combination is entered wrong, the safe will lock up for 15 minutes, frustrating the would-be burglar.
- Spacious interior fits most lap top computers.
- Two anchor holes with mounting hard-ware included.
- Attractive carpeted bottom hides anchor bolts.
- Electrostatic powder-coated finish in an attractive cream color.
- Guest instruction label included.
- Packaged for UPS shipment.

Options:

- Hand-held, print-out interrogation device, offering audit trail (HRPROG).
- Convenient 15" high safe pedestal (HRPED).

Model No.	Inside H x W x D	Outside H x W x D	Clear Door	Cubic Inch Capacity	Wt. Lbs
HR916E	8 x 15 ³ / ₄ x 11	9 x 16 x 14	7 x 12	1386	36
HRC916E	8 x 15 ³ / ₄ x 11	9 x 16 x 14	7 x 12	1386	36

*Add 2" to outside depth for lock.



The Campus Vault



Campus Vault Lock - Block and nine pin keylocking cylinder.

The AMSEC® Campus Vault

The disappearance of personal property on campus and in the corporate environment presents a serious problem. We have the solution.

Property crimes are the most common incidents on campus and the corporate office. The theft of personal and university property accounts for losses totaling hundreds of thousands of dollars each year. The more popular items to steal include wallets, purses, knapsacks, textbooks, and electronic items, in particular laptop computers.

The Campus Vault Features:

- Designed to store laptop computers and other valuables.
- Easy to use locking system offers the ultimate in low-maintenance, low-cost, key and lock control.
- Unique 9 disk keylocking system can be mastered key.
- Formed body construction offers superior pry resistance.
- Safes can be stacked and bolted together to accommodate locker type installations in various areas of the campus or corporate environment.
- Safe has two pre-drilled anchor holes on the top and bottom to allow right and left-handed operation.
- Comes equipped with two 1/4" anchor bolts for concrete or wood installation.
- Additional "Lock-Blocks" can be purchased for off-site security for personal belongings.
- Attractive chrome plated pull handle.
- One velour shelf comes as standard equipment.
- Durable powder-coated, Charcoal Gray textured finish.
- The Campus Vault only weighs 37 lbs. - easy to install in a closet, near a bed, or under a desk. Packaged for UPS shipments.

Model No.	Inside H x W x D	Outside H x W x D	Clear Door	Cubic Inch Capacity	Wt. Lbs
LB1215	12 ¹ / ₈ X 14 ⁷ / ₈ X 15 ¹ / ₈	12 ¹ / ₄ X 15 X 16	12 ¹ / ₂ x 10	1.7	36

*Add 2" to outside depth for lock.



Commercial Security Safe

The AMSEC CSC series composite safes are an affordable solution when you want to protect both documents from fire and valuables from burglary attacks. During extreme testing procedures the CSC series safes passed a 1-hour, 350°F factory fire test certification.

Features:

Door:

- Overall thickness of 4-5/8" and is constructed with a 2" defense barrier of outer and inner steel plates creating a single structure enclosing a unique, high-density fire and burglary resistant composite material.
- Defense barrier houses a proprietary amalgamation of nuggets and steel fibers to withstand concentrated attacks with the most sophisticated equipment used by burglars today.

Body:

- Total protective thickness of 2-7/8" enclosing a high-density burglary and fire resistant composite material with nuggets and steel fibers.
- High strength adjustable shelves.

Fire Endurance:

- One hour, 350°F factory fire rating. Tested at temperatures up to 1550°F.
- Fire gasket surrounding the entire door jamb.

Locking Mechanism:

- Three massive 1-1/4" diameter solid steel chrome-plated locking bolts.

- Three solid steel dead bolts lock deep into body preventing door removal during a forced entry attempt.
- U.L. Listed Type 1 (ESL-10) chrome plated electronic lock standard. Optional Group II combination lock available.
- Lock protected by a spring-loaded auxiliary relock device.
- Heavy-duty 1/4" drill resistant carburized hard plate with drill shattering tungsten carbide insert.
- Heavy duty steel hinges provide easy smooth door operation.
- One internal counter-sunk anchor hole and mounting hardware are provided to securely anchor safe.
- Attractively accented with a full width fascia panel, matching three point handle, plush velour shelves, back cover and base.
- Durable and attractive parchment textured finish.



CSC1717



Interior temperature less than 350°F for a period of 1 hour at 1550°F.

Model No.	Inside H x W x D	Outside H x W x D*	Cubic Inch Capacity	Interior Shelves	Wt. Lbs.
CSC1717	17 x 17 x 17	22 ³ / ₄ x 22 ³ / ₄ x 24 ³ / ₄	4,913	1	652
CSC2517	25 x 17 x 17	30 ³ / ₄ x 22 ³ / ₄ x 24 ³ / ₄	7,225	2	896
CSC3417	34 x 17 x 17	39 ³ / ₄ x 22 ³ / ₄ x 24 ³ / ₄	9,826	2	1055

* Add 2" to outside depth for handle, dial and hinge projection.



AMERICAN SECURITY PRODUCTS COMPANY

U.L. Listed Fire Rated Burglary Safes

WHEN FIRE AND BURGLARY ARE A CONCERN!

All four models fit into a closet!

The AMSEC BF™ Series offers a unique design that combines all the security features of a burglary safe and the peace of mind achieved with a fire safe. The industry's first U.L. listed, fire rated burglary safe offers an affordable solution when burglary and fire protection are an essential part of your buying decision!

During Underwriter's Laboratories grueling testing procedures, the BF™ series earned the U.L. listed Class 350° F, One Hour Fire Label and the (RSC) Residential Security Container Burglary Label.

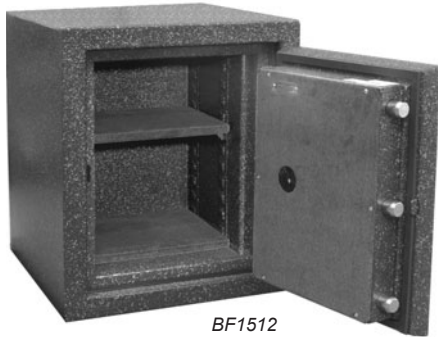

BF1512



BF2116



BF3416

Features:

- **The best warranty in the business. Lifetime fire replacement and one year parts and labor.**
- "B" rated heavy duty construction.
- **Door:** 3-1/2" thick, consisting of 1/2" plate steel with a unique proprietary fire and burglary resistant material.
- Dual seal design utilizes a silicone foam seal with a heat-expanding **intumescent seal**.*
- **Body:** 2-5/8" thick, consisting of 1/8" outer and inner steel plates creating a burglary resistant structure enclosing a unique proprietary fire resistant material.
- Three massive 1" diameter solid steel chrome-plated locking bolts.
- A full length dead bar locks deep into the body preventing door removal during a forced entry attempt.
- U.L. listed Group II lock with spring-loaded auxiliary relock device.
- 1/4" heavy duty carburized hardplate.
- Heavy duty steel hinges provide easy smooth door operation.
- One recessed anchor bolt hole and mounting hardware are provided to securely anchor safe.
- Attractively accented with a large chrome-plated dial, matching handle and a plush velour interior.
- Durable and attractive granite finish or sandstone textured with an interior of plush velour.
- Optional electronic locks are available. See pages 37-40.

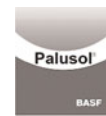

* Intumescent Door Seal:

The root word, intumes, means to react by expansion. When the intumescent seal is exposed to high temperature (above 250°F), it expands to as much as 8 times it's original thickness. In this expanded or reactive state, it has very high thermal insulating capacity and resistance to breakdown. This provides a strong positive seal between the door and body, preventing heat influx.



Lifetime Replacement Warranty:

If your BF safe is exposed to fire and failed to protect the contents, your BF safe will be replaced free of charge. Just return the safe freight prepaid to the factory accompanied with the fire report. Contact your dealer for further details.

Model No.	Inside H x W x D	Outside H x W x D	Door Opening H x W	Cubic Inch Capacity	Wt. Lbs	Interior/ Shelves
BF1512(*)(**)	15 x 12 x 13	20 1/4 x 17 1/4 x 18 3/4	15 x 12	2,340	280	1
BF1716(*)(**)	17 x 16 1/2 x 16	22 1/4 x 21 1/4 x 21 3/4	17 x 16 1/2	4,488	385	1
BF2116(*)(**)	21 x 16 1/2 x 14 1/2	26 1/4 x 21 1/4 x 20 1/4	21 x 16 1/2	5024	470	1
BF3416(*)(**)+	34 x 16 1/2 x 16	39 1/4 x 21 1/4 x 21 3/4	34 x 16 1/2	8,976	615	2

BOLT DOWN KIT INCLUDED. () Add 2" to outside depth for handle, dial and hinge projection.*

+U.L. Class 350°F, 30 minute fire label.

Hardware on above safes specify (): Brass (LTG) on Sandstone and Chrome (LTE) on Granite. Color options Specify (**): (GR)=Granite, (ST)=Sandstone*

AMERICAN SECURITY PRODUCTS COMPANY



U.L. Listed 2 Hour Fire and Impact Safes

Features:

- The best warranty in the business. Lifetime fire replacement and one year parts and labor.
- U.L. listed Class 350°F two hour fire and impact rating.
- Safes withstand fires of up to 1850°F for two hours and a 30' drop – equivalent to falling through a 2 story burning building.
- Increased barriers for burglary protection. Impressive 3-1/2" thick recessed door with 5/8" thick front for excellent pry resistance.
- Handle activated locking mechanism with 7/8" diameter solid steel chrome plated locking bolts offering smooth operation.
- Internal anchor bolt hole with hardware.
- U.L. listed Group II key changeable

combination lock with relock. 1 million possible combinations.

- Auxiliary spring-loaded relock device activated by severe attack.
- Heavy duty steel hinges provide additional security and smooth operation.
- For your convenience, rubber feet are standard on models UL1511 – 1812XD.
- Heavy duty rolling casters on UL2018 and up.
- Attractively accented with a brass-plated dial, brown powder coated handle, decorative emblems and plush velour interior.
- Available in durable Sandstone or Granite textured finishes.

Lifetime Replacement Warranty:
 If your UL safe is exposed to fire and failed to protect the contents, your UL safe will be replaced free of charge. Just return the safe freight prepaid to the factory accompanied with the fire report. Contact your dealer for further details.

Model No.	Inside H x W x D	Outside H x W x D**	Door Opening H x W	Cubic Inch Capacity	Wt. Lbs	Interior/ Shelves
UL1511(*)(**)	14 3/4 x 11 1/4 x 12	21 1/4 x 17 x 18 1/4	14 3/4 x 11 1/4	2,070	185	1
U1812(*)(**)	18 1/2 x 12 1/2 x 12	25 x 18 x 18 1/2	18 1/2 x 12 1/2	2,775	250	1
UL1812XD(*)(**)	18 1/2 x 12 1/2 x 17	25 x 18 x 23 1/2	18 1/2 x 12 1/2	3,931	305	1
UL2018(*)(**)	20 x 18 x 18	30 1/4 x 25 1/2 x 25 1/2	20 x 18	6,480	495	2
UL2818(*)(**)	28 x 18 x 18	38 1/4 x 25 1/2 x 25 1/2	28 x 18	9,072	695	2
UL3918(*)(**)	39 x 18 x 18	49 1/4 x 25 1/2 x 25 1/2	39 x 18	12,636	835	2

(*) Insert S=Sandstone or GR=Granite finish.

** Add 2" to outside depth for handle, dial and hinge projection. Outside height includes 1" rubber feet on models UL1511 – 1812XD; 2 1/4" for rolling casters on models UL2018 – UL3918.

Hardware on above safes specify (*): Brass (LTG) on Sandstone and Chrome (LTE) on Granite.

Color Options specify (**): (GR) = Granite, (ST) = Sandstone.



U.L. Fire Resistive Rating Classification

The following is an explanation of the Underwriter's Laboratories' fire resistant container testing procedures on the Class 350°F, one hour and Class 350°F two hour Fire Labels.

U.L. Label/Class 350°F-one hour and Class 350°F-two hour. The safe will maintain an interior temperature less than 350°F when exposed to fire for a period of one hour at 1700°F or for a period of two hours at 1850°F. Safe must successfully undergo all other requirements for the Fire Endurance Test, Explosion Hazard Test and the Fire/Impact Test as stated below.

Fire Endurance Test

After heat sensors and paper are placed inside the safe, the unit is locked and exposed to a uniformly distributed fire. The furnace is regulated to reach a maximum temperature of 1700°F for a period of one hour, or 1850°F for two hours, then allowed to cool without opening the furnace. The interior temperature is recorded throughout the test and during the cooling period until a definite drop is shown and must never exceed 350°F.

Once cooled, the unit is opened and examined for usability. The units locking mechanisms and parts fastenings are

examined for security and the interior examined for visible evidence of undue heat transmission

Explosion Hazard Test

The safe is locked and placed into a furnace preheated to 2000°F. This temperature is maintained for 30 minutes (2 hour test is 45 minutes) and if no explosion results, the unit is allowed to cool without opening the furnace doors. Once cooled, the unit is opened and examined for usability. The units locking mechanisms and parts fastenings are examined for security and the interior examined for visible evidence of undue heat transmission.

Fire Impact Test (Manufacturer's Option)

After the explosion hazard test the safe is removed from the furnace and within two minutes is dropped 30' onto a riprap of brick on a heavy concrete base. After impact the unit is examined for deformation, rupture of parts, damaged insulation and any other openings into the interior of the unit. Once cooled, the unit is inverted and reheated to 1550°F for a period of 30 min. (2 hour test: 45 min. at 1638°F).

Once cooled, the unit is opened and examined for usability. The units locking mechanisms and parts fastenings are examined for security and the interior examined for visible evidence of undue heat transmission.

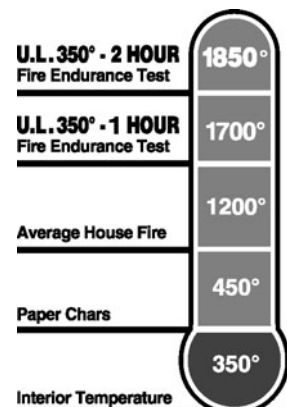
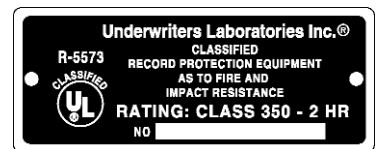



AMERICAN SECURITY PRODUCTS COMPANY

Fire Star Imported Residential Fire Safes

This economical range of Fire Star fire safes is the answer to today's high incidence of residential fires. Fire Star safes also provide burglary protection making them ideal for home and light commercial applications.

Features:

- ES-FS1013, ES-FS1310 - 350°F, one hour fire rating.
- 3 wheel combination locks with knob operated locking mechanism.
- Side boltwork mechanism incorporating two 1-1/8" chrome plate locking bolts, prevents door removal during a forced entry attempt.
- Two 1-1/8" rectangular steel deadbolt prevents door removal if hinges are removed during a forced entry attempt.
- Inner sliding tray standard.
- Impressive 5/8" thick door with attractive two-toned sage finish.
- ES1013, ES1310 - six digit easy change electronic keypad lock. Exterior battery compartment houses four AA batteries.

Fire Star Imported Commercial Fire Safes

These larger models of Fire Star fire resistant safes are designed for commercial and residential application for bulky items. The loss of important documents can severely cripple a business. Surveys have shown that 47% of all businesses do not survive after a devastating fire and that these fires strike an average of every 4 minutes.

Features:

- 350°F two hour fire rating.
- Models FS3316 – FS5737DD feature a U.L. listed Group II lock and separate key lock.
- Automatic relocking device triggered by forced entry attempt.
- Handle operated side, top and bottom locking mechanism incorporating four to six steel chromed locking bolts.
- Two to three steel deadbolts prevent door removal if hinges are removed during a forced entry attempt.
- Ball bearing hinges for ease of operation.
- Locking bolt detent preventing damage to safe body and boltwork caused by accidental door closure with bolts extended.
- Three extra deep models to accommodate oversized storage.
- Double door model designed for bulk storage.
- Adjustable inner shelves and keyed drawers.
- Casters allow for ease of movement.
- Attractive two-toned brown metallic baked enamel finish.



ES1310



FS1013



FS4922



FS5737DD

Model No.	Inside H x W x D	Outside** H x W x D	Door Opening	Cubic Inch Capacity	Wt. Lbs	Interior/ Shelves
ES1013*	9 1/4 x 13 1/4 x 9 1/2	13 1/8 x 17 x 14 3/4	9 1/4 x 13 1/4	1,164	86	1 Tray
ES1310*	13 1/4 x 9 1/4 x 9 1/2	17 x 13 1/8 x 14 3/4	13 1/4 x 9 1/4	1,164	86	1 Tray
FS1013*	9 1/4 x 13 1/4 x 9 1/2	13 1/8 x 17 x 14 3/4	9 1/4 x 13 1/4	1,164	86	1 Tray
FS1310*	13 1/4 x 9 1/4 x 9 1/2	17 x 13 1/8 x 14 3/4	13 1/4 x 9 1/4	1,164	86	1 Tray
FS3316	33 1/2 x 16 7/8 x 14 3/4	43 1/4 x 24 x 24 3/4	33 1/2 x 16 7/8	8,153	573	2
FS4122	41 1/4 x 22 3/8 x 18 1/4	51 1/4 x 29 1/2 x 28 1/4	41 1/4 x 22 3/8	16,750	842	3
FS4922	49 1/4 x 22 3/8 x 18 1/4	59 1/8 x 29 1/2 x 28 1/4	49 1/4 x 22 3/8	19,998	974	3
FS5722	57 1/8 x 22 3/8 x 18 1/4	66 7/8 x 29 1/2 x 28 1/4	57 1/8 x 22 3/8	23,237	1,102	3
FS5737DD*	57 1/8 x 37 7/8 x 17 5/8	67 1/4 x 45 x 27 1/2	57 1/8 x 37 7/8	38,107	1,455	3

*Packaged for UPS shipments.

**Add 2" to outside depth for handle, dial and hinge projection on all models listed above.

Outside height included for casters on models FS3316 - FS5737DD.

**Model FS5737DD has two keyed drawers, all other models have one.

Above dimensions have been converted from metric measurements. Please allow +1/4" - 1/4" variation for both outer and inner dimensions listed.

AMERICAN SECURITY PRODUCTS COMPANY



Fire Star Imported Data Safes

The Fire Star DS159 Diskette safe economically provides the recommended fire and humidity protection for valuable cassettes and diskettes. It is a natural companion for the computer workstation, designed to functionally complement the home and office environment.

Features:

- 125°F, one hour, 85% relative humidity, fire rating – provides protection required for cassettes and diskettes.
- Three-wheel changeable combination lock and separate key lock for dual or day lock control.
- Handle activated side locking boltwork mechanism incorporating two 3/4" diameter steel deadbolts preventing door removal if hinges are removed during a forced entry attempt.
- 1,210 cubic inch capacity accommodates eighty 8", one hundred and sixty 3.5", or one hundred and twenty 5-1/4" diskettes.
- Adjustable inner shelf.

- Mounted on casters for ease of movement between workstations.
- Attractive two-toned brown body / blue door metallic baked enamel finish.
- 26" height allows top to become a functional workstation.

MC15 Security Media Chest

- Most media begins to distort in temperatures over 150°F. This UL rated media chest certifies that your film, video, cassettes, computer discs, back up tapes, etc., will be protected in temperatures of up to 1550°F for 1 hour.
- Includes steel latch key lock for added security and easy roll wheels.
- (100) 3-1/2" or 5-1/4" diskettes
(76) 3-1/2" data cartridges

These larger Fire Star Data safes are designed to provide protection for large computer reels, tapes or disk packs. They are also ideal for large capacity storage or for film media storage.

Features:

- 125°F, one hour, (DS2720), 150°F, two hour (DS4320), 85% relative humidity, fire rating – provides protection required for media discs.
- Handle activated top, bottom and side locking boltwork mechanism incorporates four 5/8" x 1-1/4" rectangular steel chromed locking bolts, with bolt detent and relocker.

- Two 5/8" x 1-1/4" rectangular steel deadbolts prevent door removal if hinges are removed during a forced entry attempt.
- Ball bearing hinges facilitate ease of operation.
- Variety of optional adjustable interiors to accommodate all types of media storage.
- Mounted on casters for ease of movement.

Model No.	Inside H x W x D	Outside* H x W x D	Door Opening	Cubic Inch Capacity	Wt. Lbs	Interior/ Shelves
DS159	15 x 8 1/2 x 9 1/2	26 x 18 x 21	15 x 8 1/2	1,210	285	1 Shelf
DS612	6 x 11 1/2 x 6 1/4	14 1/2 x 19 x 17	6 x 11 1/2	431	132	1 Shelf
DS2720	27 x 19 1/2 x 19 1/2	41 x 30 x 33	27 x 19 1/2	10,267	816	Options
DS4320	43 x 19 1/2 x 19 1/2	59 x 33 x 36 1/2	43 x 20	16,351	1,448	Options
MC15	6" x 8 3/4" x 5 1/4"	13" x 16" x 12 1/2"	N/A	275	69	N/A

*Add 2" to outside depth for handle, dial and hinge projection.

Above dimensions have been converted from metric measurements. Please allow +1/4" - 1/4" variation for both outer and inner dimensions listed.

Fire Resistant Safes

Features:

- U.L. listed Class 350°F, 1/2 hour fire rating.
- Lined with Insulite™ insulation which will protect your documents for 30 minutes in temperatures up to 1550°F.
- Heavy duty steel latch with key lock for added security.
- Convenient carrying handle.

- DC62 designed to fit up to 45 hanging file folders w/ tabs.
- Concealed hinges.
- A convenient alternative to a bank safe deposit box.



DC23

Model No.	Inside H x W x D	Outside H x W x D	Cubic Inch Capacity	Wt. Lbs.	Interior Shelves
DC23	3" x 13" x 8 1/2"	5 5/8" x 16" x 12 1/2"	332	20	N/A
DC62	10" x 12" x 8 1/2"	13" x 16" x 12 1/2"	1020	38	N/A



DS159



DS2720



MC15

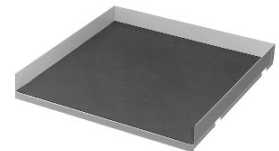

Cassette tape floppy disc shelf. Part #P1929



DC62



AMERICAN SECURITY PRODUCTS COMPANY

Cash Boxes



CB311



CB411



KB311

CB311 Cash Box with Thumb Wheel Combination Lock

Features 6 compartment cash tray. Spring clips secure bills to lid. Additional storage compartment and carry handle.

CB411 Cash Box with Key Lock

Features 7 compartment cash tray. Spring clips secure bills to lid. Additional storage compartment and carry handle.

KB66 Cash Box/Key Cabinet with Key Lock (Right-swing)

Use as either a cash box or key box. Includes a 4 compartment organization tray, predrilled holes and screws for mounting it to a drawer or wall. Holds 10 keys w/ number tags.



SB412

KB311 Key Cabinet with Thumb Wheel Combination Lock (Left-swing)

Includes 28 write on tags, and pull handle. Mounts easily to a wall (mounting hardware included).

SB412 Security Box with Key Lock

Double steel wall construction, fire retardant insulation, key lock w/2 keys, carry handle.



KB66

Model	Inside Dimensions HxWxD	Outside Dimensions HxWxD	Wt. Lbs.
CB311	2.9" x 11.19" x 7.50"	3.25" x 11.38" x 7.88"	4.4
CB411	3.50" x 10.875" x 6.81"	4.13" x 11" x 7.56"	3.8
KB66	2.375" x 6.5" x 6.5"	2.75" x 6.75" x 6.75"	2.1
KB311	2.88" x 11.31" x 7.375"	3.13" x 11.5" x 7.75"	4
SB412	3.25" x 11.75" x 7.255"	4" x 12.75" x 8.38"	7.3

Electronic Security

ES913/ES9137/ES1114 Features:

- Heavy 16 gauge solid steel construction.
- Easy to use state-of-the-art digital electronic locking system.
- Can be bolted to the wall or floor.
- Key override system.
- Dual live bolts made of heavy gauge steel.
- Pry-resistant recessed door with internal hinges for anti-theft protection.
- Mounting feet and anchor hardware standard.



ES411

ES411 Drawer/Shelf Safe Features:

- Quick-opening digital lock.
- Heavy 16 gauge solid steel construction.
- Pry-resistant recessed 10 gauge door with internal hinges.
- Two tempered-steel live bolts.
- Fits in a drawer and only requires 5" clearance.
- Key override system.
- Excellent for protecting valuables, hand guns or laptop computers.



ES913



ES9137

Model No.	Inside H x W x D	Outside H x W x D*	Door Opening	Cubic Inch Capacity	Wt. Lbs	Interiors/ Shelves
ES913	9 ¹³ / ₁₆ " x 13 ¹¹ / ₁₆ " x 7 ¹ / ₂ "	10" x 13 ⁷ / ₈ " x 9 ³ / ₄ "	7 ³ / ₄ x 10 ³ / ₄	1,007	24	0
ES9137	9 ¹³ / ₁₆ " x 13 ¹¹ / ₁₆ " x 7 ¹ / ₂ "	9 ⁷ / ₈ " x 13 ⁷ / ₈ " x 9 ³ / ₄ "	8 x 10	1,007	24	0
ES1114	11 ¹ / ₂ " x 14 ³ / ₄ " x 10 ⁷ / ₈ "	11 ³ / ₄ " x 14 ⁷ / ₈ " x 12 ¹ / ₈ "	9 ³ / ₄ x 11 ⁷ / ₈	1,843	49	1
ES411	4 ¹ / ₈ " x 11 ⁷ / ₈ " x 13 ¹ / ₈ "	5 ³ / ₈ " x 12" x 14"	10 ¹ / ₄ x 11 ⁵ / ₈	576	14	1

AMERICAN SECURITY PRODUCTS COMPANY

The Ultimate in Security

the **HS** series

The Elite

DISTINCTIVE STYLE

- High-gloss colors or textured finishes to choose from.
- Bold zinc die-cast logo.
- Decorative 5-point handle with spy-proof key locking dial.
- Diamond-stitched door panel with mirror.
- Interior is fully upholstered in a handsome desert prophecy suede fabric.
- Unique mirrored back wall provides greater visibility.

OPTIMAL FIRE PROTECTION

- Tested in a gas furnace at temperatures up to 1550° F for 2 hours, interior temperature did not exceed 350° F.
- Massive 2" thick body and 2-3/4" door is filled with a fire resistant material.
- Palusol™ door seal expands up to 8 times its original thickness when exposed to high temperatures.

UNSURPASSED SECURITY

- U.L. Listed Group II lock protected by a drill shattering hard plate and 2 additional spring-loaded reloading devices.
- Massive 1-1/2" diameter brass plated solid steel locking bolts surround entire door.
- Defense barrier of inner and outer steel plates filled with a fire insulating material to withstand concentrated attacks.

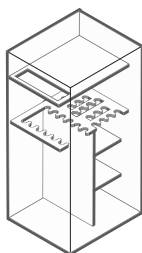
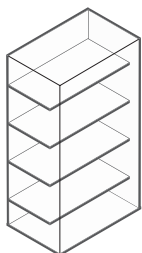

All-shelf interior (optional) All-in-one interior

The Armory

DISTINCTIVE STYLE

- High-gloss colors or textured finishes to choose from.
- Bold zinc die-cast logo.
- Decorative 3-point handle with spy-proof key locking dial.
- Interior is fully upholstered in a plush beige or silver pin dot velour fabric.

OPTIMAL FIRE PROTECTION

- Tested in a gas furnace at temperatures up to 1850° F for 2 hours, interior temperature did not exceed 350° F.
- Massive 3-1/2" body encloses a high density fire resistant composite material to protect against intense fires.

UNSURPASSED SECURITY

- U.L. Listed burglary resistant TL-30 is built to withstand severe attacks from the sophisticated equipment used by today's burglars.
- Massive 3-1/2" body and 5-3/4" door built with a defense barrier of outer and inner steel plates creating a single structure enclosing a unique, burglary resistant high security composite material.
- Equipped with a U.L. Listed Group 2M lock protected by a massive drill shattering hard plate and two additional spring-loaded reloading devices.
- Massive 1-1/2" diameter chrome plated solid steel locking bolts surround entire door.



See page 27 for color, interior and model options.



The Elite
SE6831-LG-F-PW-A



THE ARMORY
RF6528-LS-F-OX-A

Model	Outside Dimensions	Thickness Door Body	Wt	Int. Capacity	Bolts
SE6831	72H x 35W x 29 1/2D	2 3/4" 2"	1,800	12-18-30	12
RF6528 (TL-30)	72H x 35W x 29 1/2D	2 3/4" 3 1/2"	3,455	12-18-30	10



the



AMERICAN SECURITY PRODUCTS COMPANY

The Most Unique Gun Safe Line series in the Industry



BF6032-LG-GR-A



Substantial 4 3/4" thick door offers superior fire and burglary protection.



BF7240-LE-OX-A

REAL SECURITY:

- Body encloses a proprietary DryLight insulation eliminating the use of gypsum board.
- 2" total wall thickness on all sides.
- Two layers of steel consisting of an outer and inner steel liner for dual security protection.
- 4 pre-cut anchor holes and 1 pre-cut electrical access hole.
- Awarded the U.L. Residential Security Container (RSC) burglary classification.
- 1/2" steel plate door combined with 1" DryLight insulation.
- 10 massive 1 1/2" thick locking bolts to provide superior door security.
- Commercial grade high security exterior hinges for additional security and full access to the elegant interior.
- Equipped with a U.L. listed group II lock protected by a massive hardplate.

- New DryLight insulation is poured between inner and outer steel walls for premier fire protection.
- Dual fire seals around entire door. Silicon seal on door jamb & palusol seal on door giving the door a snug fit with added fire protection. Palusol seal expands up to 8 times its original thickness when exposed to heat.

QUALITY STYLE THROUGHOUT

- Unique mirrored back wall in the interior of the safe providing higher interior visibility.
- Bold zinc die cast polished brass or chrome logos.
- Spy-proof key locking dial with decorative three spoke handle.
- Interior shelves fully upholstered in a pin-dot fabric (standard feature).
- Interior shelving can be adjusted to meet your unique storage needs.
- Interior door panel finished in full pin-dot fabric.
- Select from five hand-painted high-gloss (Platinum Finish added) and four textured finishes.

UNMATCHED FIRE PROTECTION

- Mercury class II fire protection of 1275 degrees for 90 minutes. Designed to maintain an interior temperature of less than 350 degrees.

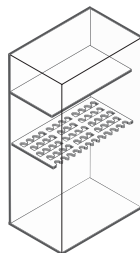

58 Gun Interior For Models: BF7240, BF6040

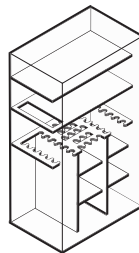

12-18-24-30-42 Gun Interior For Models: BF7240, BF6040

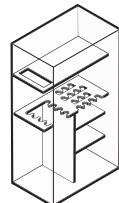

8-14-22 Gun Interior For Model BF6032

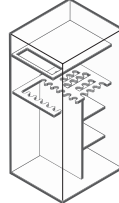

12-18-30 Gun Interior for models SE6831, RF6528 & BF6030

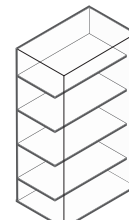

All-shelf interior (optional for all BF models)



Lifetime Replacement Warranty:
Please see our Gun Safe Brochure for Details

See page 27 for color, interior and model options.

Model	Outside Dimensions	Thickness Door	Body	Wt	Int. Capacity	Bolts
7240	71 1/4"H x 40W x 26D	4 3/4"	2"	1305	12-18-24-30-42 58 gun	10
6040	59 1/4"H x 40W x 26D	4 3/4"	2"	1115	12-18-24-30-42 58 gun	10
6030	59 1/4"H x 30W x 26D	4 3/4"	2"	885	12-18-30	10
6032	59 1/4"H x 30W x 21D	4 3/4"	2"	810	8-14-22	10



the LP series

Models LP6030W, LP6032W & LP5924W:

DISTINCTIVE STYLE

- Black textured finish with bold zinc die cast polished brass logos, a rich velour back cover and fire walls with durable American Oak wood finish interior.
- Brass Spy-Proof dial and "L" handle.
- External hinges easily provide full access to your safe.

FIRE PROTECTION

- The LP6032W, LP6030W and LP5924W offer fire protection of 1200°F, for a period of 45 minutes. Designed to maintain an interior temperature of less than 350°F.
- Palusol™ door seal expands up to 8 times its original thickness when exposed to high temperatures sealing safe contents from harm.

THEFT DEFIANT

- High strength unitized 12 gauge solid steel body.
- Massive 1 3/4" recessed door constructed of a 1/4" solid steel plate and a fire insulating material.
- Equipped with a Group II, key-changeable combination lock with brass spy-proof dial and ring.
- 3-way boltwork with 5 active 1 1/4" diameter chrome-plated steel locking bolts and three 1 1/4" deadbolts.
- Each safe offers 4 pre-cut anchor holes and 1 pre-cut electrical access hole.



This safe meets or exceeds the standards for California-approved Firearms Safety Devices and the requirements of California Penal Code Section 12088, Gun Safe Standards

Model 5517:

- Interior features an attractive American Oak wood finish with carpeted back cover and walls. Includes one adjustable shelf and an eleven-gun storage rack.
- Brass spy-proof dial with decorative brass "L" handle accompanied by the renowned American Security Products solid brass logo plate.
- Durable black powder coated finish.
- Sleek style is designed to fit into a closet.
- Mercury Class I fire at 1000° F, for a period of 20 minutes. Designed to maintain an interior temperature of less than 350°F.
- Fire-resistant door seal.
- High strength unitized 12 ga. body and 1/4" thick solid steel recessed door.
- 3-way boltwork with five active 1" diameter chrome-plated locking bolts
- Equipped with a 3 wheel combination lock protected by a drill-resistant hard plate.
- 2 pre-cut anchor holes with mounting hardware included, and 2 pre-cut electrical access holes.



LP6030W

Substantial 1 3/4" thick door

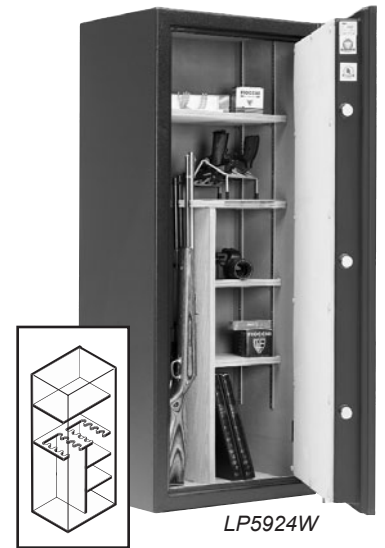

LP5924W

Model HC1854 only:

- Available in oak or cherry finish.
- Inside lined with plush tan velour fabric.
- Mercury Class I fire at 1200°F, for a period of 45 minutes. Designed to maintain an interior temperature of less than 350°F.
- High strength double wall unitized 14 ga. body and a 3/4" thick formed door.
- Group II lock and front read dial protected by a drill resistant hardplate.
- 5 one-inch chrome-plated steel locking bolts.

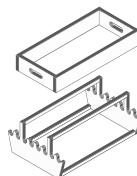

HC1854



Model	Outside Dimensions	Thickness Door	Body	Wt Lbs.	Interior Capacity	Bolts
LP5924W	59 1/4"H x 24W x 18D	1 3/4"	12ga	490	8-8-16	5
LP6032W	59 1/4"H x 30W x 21D	1 3/4"	12ga	632	10-10-20	5
LP6030W	59 1/4"H x 30W x 26D	1 3/4"	12ga	692	14-14-28	5
5517W	55 1/4"H x 17 1/2"W x 16D	3/16"	12ga	252	11 Gun	5
HC1854-HCC	18H x 54 1/4"W x 22D	3/4"	14ga	450*	8 Gun	5

*375 lbs. w/o wood cabinet



5517W



Smith & Wesson® Home Security Safes



SW3020



SWPB2
SWPB1



PB1-M

PB2 w/5BE



SWVV1014

Distinctive Style

- Protect your important documents, cash and other valuables conveniently at home. The Smith & Wesson Home Security series offers an unbeatable value, featuring a rich velour back cover and fire walls with durable American Oak wood finish interior.
- Smith & Wesson deep blue textured finish with bold zinc die cast polished chrome logo.
- Spy-Proof dial and chrome "L" handle.
- External hinges easily provide full access to your safe.

Fire Protection

- Fire protection of 1200°F, for a period of 30 minutes. Designed to maintain an interior temperature of less than 350°F.

Theft Defiant

- High strength unitized 12 gauge solid steel body.
- Massive 1-1/8" recessed door constructed of a 1/4" solid steel plate and a fire insulating material.
- Equipped with a 3 wheel combination lock protected by a drill resistant hard plate. (U.L. listed Group II combination or electronic lock available).
- 3-way boltwork with 5 active 1-1/4" diameter chrome-plated steel locking bolts. (2020 model has 4 active locking bolts).
- Each safe offers 4 precut anchor holes.



Model #	Outside Dimensions H x W x D*	Inside Dimensions H x W x D	Cu. Inch	Thickness Door Body	Total Bolts	Interior Shelves	Wt. Lbs.
SW2020	20 x 20 x 20	17-1/2 x 18-1/4 x 16-1/4	4710	1-1/8" 12 ga.	6	1	158
SW3020	30 x 20 x 20	27-1/2 x 18-1/4 x 16-1/4	7402	1-1/8" 12 ga.	8	2	215
SW4020	40 x 20 x 20	37-1/2 x 18-1/4 x 16-1/4	10094	1-1/8" 12 ga.	8	3	270

*Add 2" for handle, dial and hinge projection.

Handgun Security

SWPB1 & SWPB2:

- AMSEC "5BE" electronic push button lock is fast and easy to use.
- Replaces high cost mechanical lock alternatives with higher reliability.
- Easy change combination with programmable override code for lost combinations.
- 9 VDC battery provides over 5000 openings with low battery indicator.
- External auxiliary battery connection.
- Tamper proof penalty lockout protects against manipulation attempts.
- LED status and beeper can be programmed on - off.
- S&W deep blue finish with chrome hardware.
- Strong, pry resistant custom chrome locking bolt.

- Key override system.
- Designed to be secured for either vertical or horizontal installation with the steel mount plate.
- A unique removable internal holster presents firearm for rapid response.
- Internal illumination, tamper alarm and low battery indicator are standard.

AMSEC'S PB1-2 AND PB1-2/M:

- STANDARD FEATURES: • CAL DOJ approved • Gray powder coated finish with chrome hardware • Heavy-duty chrome handle • Strong, pry-resistant chrome locking bolt • Interior cushioned with foam lining to protect against scratches.
- **PB1-5BE / PB2-5BE (ELECTRONIC PUSH BUTTON):** • Easy to change combination with programmable override code • 9V DC battery provides over 5,000 openings with low-battery indicator • External auxiliary battery connection.
- **PB1-M/PB2-M (MECHANICAL PUSH BUTTON LOCK):** • Five-button lock for quick and easy access • No keys to lose or batteries to replace.

VersaVault (SWVV1014):

- Electronic lock with four button lighted keypad offers more than 65,000 possible combinations.

Model	Outside Dimensions	Wt.
SWVV1014	14.2 H x 10 W x 3.75 D	11.4 lbs.
SWPB1	8 H x 12 W x 3 D	7.5 lbs.
SWPB2	8 H x 12 W x 4 D	8 lbs.
PB1(with 5BE)	8 H x 12 W x 3 D	7.5 lbs.
PB1-M	8 H x 12 W x 3 D	7.5 lbs.
PB2(with 5BE)	8 H x 12 W x 4 D	8 lbs.
PB2-M	8 H x 12 W x 4 D	8 lbs.



Accessories & Options (HS/BF Series)

Upgrade to the "Premium" package

When you choose to upgrade your American Security HS or BF series safe with a "Premium" package, we'll add on some of our most popular options including:
 A) a 5-point handle, B) fluorescent light kit, C) a GunSaver dehumidifier, D) an attractive jewelers tray and E) an internal power outlet

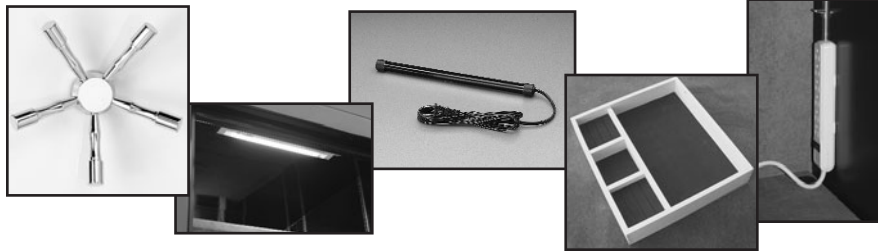

Color Options:

Hi Gloss Exterior Colors:
 Hunter Green(HG), Onyx(OX), Burgundy(BY), Pearl(PW), Platinum Finish (PL).

Textured Exterior Colors:
 Granite(GR), Sandstone(ST), Black(BK), Green(GN).



Individual Options



GunSaver Dehumidifier:
 Will constantly guard your guns against the threat of rust, pitting and moisture damage. Electrical access is required.

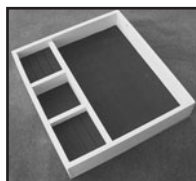

Jewelry Tray:
 Conveniently fits into every safe. Burgundy felt lined. 10³/₈ x 9³/₈ x 2



Pistol Rack: Ideal for organizing pistols inside your safe. This four gun pistol rack sits on top of an interior shelf.



Desiccant: Prevents rust & moisture damage. Recommended for safes without electrical access (Safes with the fireliner option).

Oak Cabinet: Convenient oak cabinet for easy storage fits 12-18-30 or 12-18-24-30-42 interiors. Includes easy out access gun rack with 12-18-30 interior. O.D. 34 x 10³/₄ x 17³/₄

Fire and Burglary Protection

American Security Products Co. gun safes offer the level of fire protection you need to safeguard your valuables. Our HS series features a massive 2" to 3¹/₂" body and 2³/₄" door filled with a proprietary high security fire resistant material, offering Class III fire protection. Our BF Series features a massive 2" body and 4³/₄" door filled with a proprietary DryLight fire resistant insulation, offering Class II fire protection. The LP Series features a multi-layer insulation with 1 to 3 layers of 5/8" fireboard construction (1 to 2 layers of 3/8" on model 5517W), offering Class 1 fire protection.

Series I Model	Outside Temperature	Period (Time)	Inside Temperature Less than*	U.L. Burglary Rating	Meets DOJ Standards	Warranty
SE6831	1550°F	120 Minutes	350°F	RSC	Yes	Lifetime
RF6528	1850°F	120 Minutes	350°F	TL-30	Yes	Lifetime
BF Series	1275°F	90 Minutes	350°F	RSC	Yes	Lifetime
LP6030W	1200°F	45 Minutes	350°F	B-Rate	Yes	Lifetime
LP6032W	1200°F	45 Minutes	350°F	B-Rate	Yes	Lifetime
LP5924W	1200°F	45 Minutes	350°F	B-Rate	Yes	Lifetime
5517W	1000°F	20 Minutes	350°F	B-Rate	Yes	Parts and Labor Only
HC1854	1200°F	45 Minutes	350°F	B-Rate	No	Parts and Labor Only
S & W Home Security	1200°F	30 Minutes	350°F	B-Rate	Yes	Parts and Labor Only

*Each safe is designed to maintain an interior temperature less than 350°F. Paper products will char at approximately 450°F.



AMERICAN SECURITY PRODUCTS COMPANY

DXE/DXF, CDXE/CDXF U.L. Listed TL-15 & TL-30 Money Chests

AMSEC TL-15 and TL-30 U.L. listed Money Chests qualify for Mercantile & Broadform Insurance Class ER (TL-15) and F (TL-30) with a bank rating of BR (TL-15) and G (TL-30). AMSEC Money Chests offer the highest level of security available with many outstanding features and a wide range of options.



CDXE2020
TL-30 Composite Body and Plate Door



DXE1818
TL-15 Plate Body and Door

Features:

Door:

- DXE and CDXE models are TL-15 rated constructed of 3/4" thick solid steel plate.
- DXF and CDXF models are TL-30 constructed of 1-3/4" thick laminated steel with a special hardened drill resistant plate.
- Oil impregnated bronze bearing hinges.

Body:

- DXE and DXF models: consist of 3/4" thick steel plate (50,000 P.S.I. minimum tensile strength). All external seams are beveled and continuously welded.
- CDXE and CDXF models: consist of 3-1/4" thick body constructed of inner and outer steel plates enclosing a high density composite material.
- Shelf strips installed allowing shelf adjustment. Shelves optional.

Locking Mechanism:

- U.L. listed Group II key changeable combination lock, with relock and 1 million possible combinations.
- Dual auxiliary spring loaded reloading device, activated by a punching attack.
- Locks and relocks protected by a large proprietary drill shattering composite hardplate.
- A handle activated locking mechanism consisting of two to five 1" chromed steel locking bolts.
- Five boltwork sizes allow AMSEC to build units from 10" (10-1/2" for DXE/DXF) to 88" high, widths from 12" to 41".
- Solid steel dead bar prevents door removal if hinges are removed during a forced entry attempt.
- Compact locking mechanism and boltwork cover allow for optional door mounted coin racks.

Hinges:

- Fabricated from high strength steel with precision machined alloy dowel pins.
- Oil impregnated bronze bearing assures easy opening doors and reduced maintenance.
- Vertical height adjustment.

Finish:

- Available in Black, Blue Gray, Parchment or the standard Gray textured finish.

OPTIONS:

- Spyproof dial
- Key lock dial
- Coin racks
- Managers lockers
- Interior lockers
- Interior drawers
- Adjustable shelves
- Group 1 and 1R locks
- Electronic locks
- Access Control Systems
- Key-Op locks
- Dual combination locks (some models)
- 144 hour timelock
- 15 minute time delay lock
- External day lock
- Claddings
- Anchor bolt assembly
- Left swing door
- Internal rotary hopper
- Internal deposit slot
- Internal deposit chutes
- Hidden compartments
- Modular alarm
- Hold up duress alarm
- Special sizes
- Custom colors

AMERICAN SECURITY PRODUCTS COMPANY

MODEL DXE or CDXE — ER RATED — Underwriter's Laboratories Listed TL-15, MODEL DXF or CDXF — F RATED — Underwriter's Laboratories Listed TL-30

MODEL # (DXE DXF, CDXE OR CDXF)	INSIDE DIM. H" W" D" DXE** / DXF	OUTSIDE DIMENSIONS*				CUBIC INCH CAPACITY DXE / DXF	WEIGHT LBS. DXE / DXF	INSIDE DIM. H" W" D" CDXE** / CDXF	OUTSIDE DIMENSIONS*				CUBIC INCH CAPACITY CDXE / CDXF	WEIGHT LBS. CDXE / CDXF	CLEAR DOOR OPENING FOR ALL MODELS
		HEIGHT x WIDTH		DEPTH					HEIGHT / WIDTH		DEPTH				
		DXE & DXF	DXE	DXF	DXE				DXF	CDXE / CDXF	CDXE	CDXF			
1212	12 x 12 x 12	14 x 14	17	17-3/4	1,800 / 1,728	341 / 397	12 x 12 x 12	18-3/4 X 18-1/2	19	19-3/4	1,728	457 / 498	11 x 10-3/4		
1414	14 x 14 x 12	16 x 16	17	17-3/4	2,401 / 2,352	406 / 480	14 x 14 x 12	20-3/4 X 20-1/2	19	19-3/4	2,352	536 / 589	13 x 12-3/4		
1616	16 x 16x 12	18 x 18	17	17-3/4	3,136 / 3,072	457 / 569	16 x 16 x 12	22-3/4 X 22-1/2	19	19-3/4	3,072	618 / 684	15 x 14-3/4		
1818	18 x 8 x 12	20 x 20	17	17-3/4	3,969 / 3,888	554 / 669	18 x 18 x 12	24-3/4 X 24-1/2	19	19-3/4	3,888	710 / 790	17 x 16-3/4		
2018	20 x 18 x 16	22 x 20	21	21-3/4	5,850 / 5,760	682 / 809	20 x 18 x 16	26-3/4 X 24-1/2	23	23-3/4	5,760	857 / 945	19x 16-3/4		
2020	20 x 20 x 20	22 x 22	25	25-3/4	8,100 / 8,000	820 / 960	20 x 20 x 20	26-3/4 X 26-1/2	27	27-3/4	8,000	1,018 / 1,115	19 x 18-3/4		
2416	24 x 16 x 16	26 x 18	21	21-3/4	6,240 / 6,144	719 / 854	24 x 16 x 16	30-3/4 X 22-1/2	23	23-3/4	6,144	902 / 995	23 x 14-3/4		
2420	24 x 20 x 20	26 x 22	25	25-3/4	9,720 / 9600	918 / 1,183	24 x 20 x 20	30-3/4 X 26-1/2	27	27-3/4	9,600	1,131 / 1,245	23 x 18-3/4		
2424	24 x 24 x 20	26 x 26	25	25-3/4	11,664 / 11,520	1,023 / 1,217	24 x 24 x 20	30-3/4 X 30-1/2	27	27-3/4	11,520	1,254 / 1,387	23 x 22-3/4		
2424XD	24 x 24 x 24	26 x 26	29	29-3/4	13,968 / 13,824	1,136 / 1,330	24 x 24 x 24	30-3/4 X 30-1/2	31	31-3/4	13,824	1,381 / 1,514	23 x 22-3/4		
3018	30 x 18 x 16	32 x 20	21	21-3/4	8,775 / 8,640	894 / 1,079	30 x 18 x 16	36-3/4 X 24-1/2	23	23-3/4	8,640	1,105 / 1,232	29 x 16-3/4		
3018XD	30 x 18 x 20	32 x 20	25	25-3/4	10,935 / 10,800	1,007 / 1,192	30 x 18 x 20	36-3/4 X 24-1/2	27	27-3/4	10,800	1,235 / 1,080	29 x 16-3/4		
3020	30 x 20 x 20	32 x 22	25	25-3/4	12,150 / 12,000	1,065 / 1,268	30 x 20 x 20	36-3/4 X 26-1/2	27	27-3/4	12,000	1,301 / 1,440	29 x 18-3/4		
3024	30 x 24 x 20	32 x 26	25	25-3/4	14,580 / 14,400	1,182 / 1,421	30 x 24 x 20	36-3/4 X 30-1/2	27	27-3/4	14,400	1,438 / 1,601	29 x 22-3/4		
3028	30 x 28 x 20	32 x 30	25	25-3/4	17,010 / 16,800	1,299 / 1,573	30 x 28 x 20	36-3/4 X 34-1/2	27	27-3/4	16,800	1,574 / 1,762	29 x 26-3/4		
3030	30 x 30 x 20	32 x 32	25	25-3/4	18,225 / 18,000	1,357 / 1,650	30 x 30 x 20	36-3/4 X 36-1/2	27	27-3/4	18,000	1,641 / 1,841	29 x 28-3/4		
3624	36 x 24 x 20	38 x 26	25	25-3/4	17,496 / 17,280	1,378 / 1,629	36 x 24 x 20	42-3/4 X 30-1/2	27	27-3/4	17,280	1,626 / 1,819	35 x 22-3/4		
4024	40 x 24 x 20	42 x 26	25	25-3/4	19,440 / 19,200	1,451 / 1,765	40 x 24 x 20	46-3/4 X 30-1/2	27	27-3/4	19,200	1,749 / 1,962	39 x 22-3/4		
4034	40 x 34 x 26	42 x 36	31	31-3/4	35,700 / 35,360	2,051 / 2,482	40 x 34 x 26	46-3/4 X 40-1/2	33	33-3/4	36,360	2,424 / 2,717	39 x 32-3/4		
4524	45 x 24 x 20	47 x 26	25	25-3/4	21,870 / 21,600	1,583 / 1,934	45 x 24 x 20	51-3/4 X 30-1/2	27	27-3/4	21,600	1,901 / 2,139	44 x 22-3/4		
5024	50 x 24 x 20	52 x 26	25	25-3/4	24,300 / 24,000	1,716 / 2,104	50 x 24 x 20	56-3/4 X 30-1/2	27	27-3/4	24,000	2,054 / 2,317	49 x 22-3/4		
5030	50 x 30 x 20	52 x 32	25	25-3/4	30,375 / 30,000	1,950 / 2,425	50 x 30 x 20	56-3/4 X 36-1/2	27	27-3/4	30,000	2,326 / 2,648	49 x 28-3/4		
5034	50 x 34 x 26	52 x 36	31	31-3/4	44,625 / 44,200	2,399 / 2,932	50 x 34 x 26	56-3/4 X 40-1/2	33	33-3/4	44,200	2,821 / 3,183	49 x 32-3/4		
5224	52 x 24 x 20	54 x 26	25	25-3/4	25,272 / 24,960	1,768 / 2,171	52 x 24 x 20	58-3/4 X 30-1/2	27	27-3/4	24,960	2,115 / 2,388	51 x 22-3/4		
5234	52 x 34 x 20	54 x 36	25	25-3/4	35,802 / 35,360	2,170 / 2,723	52 x 34 x 20	58-3/4 X 40-1/2	27	27-3/4	35,360	2,582 / 2,957	51 x 32-3/4		
6030	60 x 30 x 20	62 x 32	25	25-3/4	36,450 / 36,000	2,249 / 2,816	60 x 30 x 20	66-3/4 X 36-1/2	27	27-3/4	36,000	2,671 / 3,054	59 x 28-3/4		
6034	60 x 34 x 20	62 x 36	25	25-3/4	41,310 / 40,800	2,426 / 3,061	60 x 34 x 20	66-3/4 X 40-1/2	27	27-3/4	40,800	2,877 / 3,308	59 x 32-3/4		
7234	72 x 34 x 26	74 x 36	31	31-3/4	64,260 / 63,648	3,175 / 3,933	72 x 34 x 26	78-3/4 X 40-1/2	33	33-3/4	63,648	3,706 / 4,218	71 x 32-3/4		
8234	82 x 34 x 26	84 x 36	31	31-3/4	73,185 / 72,488	3,523 / 4,383	82 x 34 x 26	88-3/4 X 40-1/2	33	33-3/4	72,488	4,103 / 4,685	81 x 32-3/4		

* Add 2" to outside depth for handle, dial and hinge projection. ** Add 1/4" to all DXE (TL-15) plate safe inside depth dimensions.



AMERICAN SECURITY PRODUCTS COMPANY

ACF TL-30 Fire Rated Composite Money Chest



ACF4024 shown with auxiliary keylock



AMSEC TL-30 U.L. listed Money Chests qualify for Mercantile & Broadform Insurance Class F with a bank rating of G. AMSEC composite Money Chests offer the highest level of security available for today's market. The composite body and door offer outstanding burglary and fire protection all in one safe.

Features:

Door:

- 5-1/2" thick door constructed of outer and inner steel plates enclosing a high density proprietary composite material.
- Two hour, 350°F factory fire rating. Tested at temperatures up to 1850°F.
- Bolt tensioner keeps locking bolts retracted in the open position.
- Handle designed to shear in case of forced entry attempt.
- Solid steel dead bars prevent door removal if hinges are removed during a forced entry attempt.

Body:

- 3-1/4" thick body constructed of inner and outer steel plates enclosing a high density proprietary composite material.
- Door and inner jamb surrounded by thick solid steel bars.
- Adjustable shelves.

Locking Mechanism:

- U.L. listed Group II key changeable lock, with relock and 1 million possible combinations.
- Dual auxiliary spring-loaded relocking device, activated by a punching attack.
- Locks and relocks protected by a large proprietary drill shattering composite hardplate.
- A handle activated locking mechanism consisting of three to five 1" diameter chromed steel locking bolts.
- Five boltwork sizes allow AMSEC to build units from 12" to 88" high, widths from 20" to 48".

Hinges:

- Ball bearing hinges fabricated from high strength steel.
- Precision machined alloy dowel pins.
- Oil impregnated bronze bearing assures easy opening doors and reduced maintenance.
- Vertical height adjustment.

Finish:

- Available in Satin Black, Blue Gray, Parchment or the standard Gray textured finish.



ACF4824DS

Model No.	Inside H x W x D	Outside* H x W x D	Door Opening	Cubic Inch Capacity	Wt. Lbs.	Interiors Shelves
ACF2020	20 x 20 x 20	26 ³ / ₄ x 26 ¹ / ₂ x 28 ³ / ₄	19 x 18 ³ / ₄	8,000	1,114	2
ACF2020XD	20 x 20 x 24	26 ³ / ₄ x 26 ¹ / ₂ x 32 ³ / ₄	19 x 18 ³ / ₄	9,600	1,201	2
ACF3020	30 x 20 x 20	36 ³ / ₄ x 26 ¹ / ₂ x 28 ³ / ₄	29 x 18 ³ / ₄	12,000	1,397	2
ACF3020XD	30 x 20 x 24	36 ³ / ₄ x 26 ¹ / ₂ x 32 ³ / ₄	29 x 18 ³ / ₄	14,400	1,531	2
ACF4024	40 x 24 x 20	46 ³ / ₄ x 30 ¹ / ₂ x 28 ³ / ₄	39 x 22 ³ / ₄	19,200	1,872	2
ACF4024XD	40 x 24 x 24	46 ³ / ₄ x 30 ¹ / ₂ x 32 ³ / ₄	39 x 22 ³ / ₄	23,040	2,035	2
ACF5024	50 x 24 x 20	56 ³ / ₄ x 30 ¹ / ₂ x 28 ³ / ₄	49 x 22 ³ / ₄	24,000	2,217	2
ACF5024XD	50 x 24 x 24	56 ³ / ₄ x 30 ¹ / ₂ x 32 ³ / ₄	49 x 22 ³ / ₄	28,800	2,401	2
ACF6030	60 x 30 x 20	66 ³ / ₄ x 36 ¹ / ₂ x 28 ³ / ₄	59 x 28 ³ / ₄	36,000	2,892	2
ACF6030XD	60 x 30 x 26	66 ³ / ₄ x 36 ¹ / ₂ x 34 ³ / ₄	59 x 28 ³ / ₄	46,800	3,225	2
ACF4824DS**	(top) 26 x 18 x 14 (bottom) 14 x 18 x 17	47 ³ / ₄ x 24 ¹ / ₂ x 25 ³ / ₄	25 x 16 ³ / ₄ 13 x 16 ³ / ₄	6,552 4,284	1,654	2 0

*Add 2" to outside depth for handle, dial and hinge projection.
**DS=Double Door Depository Safe

AMERICAN SECURITY PRODUCTS COMPANY

ACF TL-30 Depository Safe

AMSEC's ACF TL-30 double door depository safe offers complete cash management versatility for any operation that requires a nonreturnable deposit such as armored car companies, convenience stores, restaurants, etc. The U.L. listed TL-30 composite construction offers peace of mind when overnight protection is required.

In addition to the outstanding features listed under ACF TL-30 Money Chest, the ACF4824DS Depository safe also offers:

Top Deposit/Storage Compartment

- Outer door equipped with a U.L. listed Group II combination lock and chrome plated front read dial.
- Large storage capacity: accommodates up to nine cash register trays.
- Large 3" x 18" deposit chute is protected by an "anti-fish", saw-tooth, hinged baffle.
- Two adjustable shelves.
- Door mounted four-opening rolled coin storage rack.

Bottom Receiving Compartment

- Outer door equipped with a U.L. listed Group II combination lock, chrome plated front read dial and an auxiliary key-op lock for dual control or armored car pick up.

Options:

- Electronic locks, Group 1 and 1R locks.
- Dual combination locks (Receiving compartment only).
- Spyproof dial, Keylock dial.
- Modular alarm, Holdup alarm.
- Interior lockers, Interior drawers, Adjustable shelves.
- Custom sizes/designs quoted upon request.
- Access Control Systems.

Finish:

- Available in Satin Black, Blue Gray, Parchment or the standard Gray textured finish.

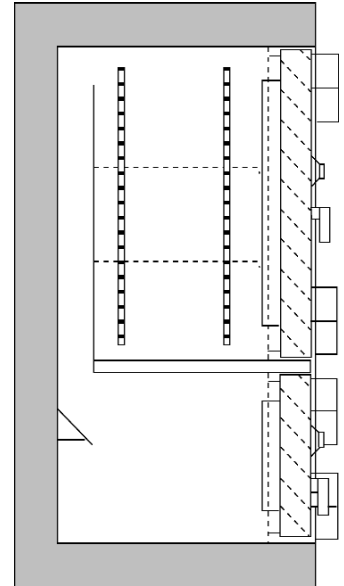

Interior view of ACF4824DS
(from the side)

VAULT DOOR - VD8030

Turn an entire room or closet into a security center

- Your very own personal vault in the convenience of your own home.
- Instead of buying three different safe sizes over a lifetime, why not just buy one vault door?
- Retrofits a standard 80" x 30" interior door.
- Adjustable doorframe slides together to fit a wall thickness of 4 1/2" to 7 1/2."
- 1" thick door offers a defense barrier constructed of 1/8" inner and outer steel plates filled with a fire insulation material that provides a barrier against extreme heat.
- Ten massive 1 1/4" thick bolts.
- Weight: 395 lbs. / Shipping Weight: 615 lbs.
- Satin black finish with 3-spoke polished brass handle and spy proof, key locking dial.
- Matching elegant scroll work.
- Minimum opening required: 79 1/2"H x 29 1/2"W
- Outside: 83 1/8"H x 36 1/2"W
- Door opening: 77 1/2"H x 26 1/2"W
- B rate to TL-30 constructed custom vault doors quoted upon request.



Make your vault room double as a storm shelter with our in-swing vault door. Offering the same features as our standard vault door, the in-swing vault door will insure opening from the inside even if debris has blocked the door.



THE AMVAULT
FIRE RATED COMPOSITE TL-15 & TL-30

AMERICAN SECURITY PRODUCTS COMPANY

AMVAULT TL-30 and TL-15 Fire Rated Composite Safes

During extreme testing procedures, AMVAULT composite safes demonstrated the ability to withstand severe attacks by experienced U.L. experts using powerful tools such as sledgehammers, power saws, carbide disc cutters, drills, etc., and without fail, were awarded the U.L. TL-15 and TL-30 labels.

Besides withstanding the most concentrated attacks by sophisticated burglars, each AMVAULT safe offers a Two Hour, 350° F factory fire test certification, ensuring the protection of the vault's contents against intense fires.



CF5524



CF6528 with optional interior lockers



CE2518

Features:

Door:

- Overall thickness of 5-3/4" and is constructed with a 2-3/4" defense barrier of outer and inner steel plates creating a single structure enclosing a unique, high density fire and burglary resistant composite material.
- Defense barrier houses a proprietary amalgamation of nuggets and steel fibers to withstand concentrated attacks with the most sophisticated equipment used by burglars today.
- The Amvault TL-30 offers a massive solid steel hard plate covering the entire door.

Body:

- The Amvault formed body has a total protective thickness of 3-1/2" enclosing a high density fire resistant composite material with nuggets and steel fibers.
- A reinforced drill resistant door frame protects the door and each individual bolt chamber from severe side attacks.
- A proprietary inner barrier protects against peeling attacks.
- High strength adjustable shelves.

Fire Endurance:

- Two hour, 350°F factory fire rating. Tested at temperatures up to 1850°F

Locking Mechanism:

- Equipped with six to ten massive 1-1/2" diameter chrome plated solid steel locking bolts. Each bolt moves deep into the body's protected bolt chambers.
- Entire boltwork mechanism is also protected by a spring operated boltwork detent system. Bolts stay in the retracted position when the door is opened and automatically engage when the door is closed.

Three-Way Boltwork Option (TL-30 Only):

- Safes can be equipped with a three way active boltwork mechanism engaging the bolts horizontally and vertically into the body of the safe.

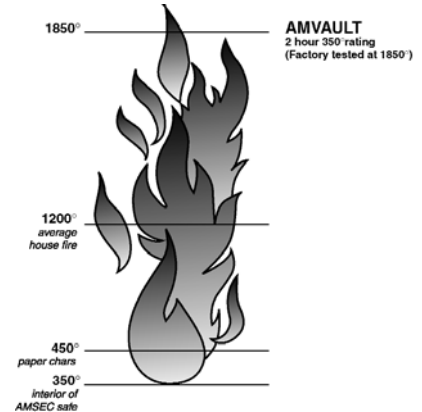

Locks:

- Equipped with a U.L. listed Group II key changeable combination lock. The lock is protected by a massive drill shattering hard plate and two additional spring-loaded devices.

Hinges:

- Offers a vertical height adjustment and utilizes an oil impregnated bearing ensuring easy door operation.

Optional Auxiliary Key Lock:

- U.L. listed, high security auxiliary key lock is also available on all AMVAULT safes (except Model 1814). Lock is equipped with 2 keys and escutcheon plate.

- An additional spring-loaded relock device protecting lock against punch attacks.

Optional Glass Relocking Mechanism (TL-30 Only):

- Incorporated into the AMVAULT TL-30 auxiliary key lock is an optional high security tempered glass relock mechanism with a remotely and randomly placed "cross locking" relocking bolt and thermal cords to protect against torch attacks.
- In the event of an attack by tools, torches, or explosives, the glass will shatter activating the highly sophisticated relock mechanism.
- Utilizing the glass relock mechanism can offer up to a total of six different relock devices offering the ultimate in high security protection.

AMERICAN SECURITY PRODUCTS COMPANY

AMVAULT Specifications

AMVAULT High Security Composite safes have passed Underwriter's Laboratories most recent testing procedures ensuring you today's best protection. AMVAULT TL-15 and TL-30 U.L. listed composite safes qualify for Merchantile & Broadform Insurance Class *ER* (TL-15) and *F* (TL-30) with a Bank Rating of *BR* (TL-15) and *G* (TL-30). Two Hour Class 350°F manufacturers' fire label.

Standard finish is Parchment. Other colors available on request.

Model No.	Inside	Outside	Cubic Feet	Wt. Lbs TL-15/TL-30	Interior/ Shelves	Door Swing		
	H x W x D	H x W x D*				A	B	C
(†)1814**	18 x 14 x 12	25 x 21 x 21½	1.8	700 / 710	1	14	36	39½
(†)2518	25 x 18 x 16	32 x 25 x 25½	4.2	1,110 / 1,125	1	18	44	47½
(†)3524	35 x 24 x 20	42 x 31 x 29½	9.7	1,720 / 1,764	2	24	56	57½
(†)4524	45 x 24 x 20	52 x 31 x 29½	12.5	2,060 / 2,100	3	24	56	57½
(†)5524	55 x 24 x 20	62 x 31 x 29½	15.3	2,410 / 2,474	3	24	56	57½
(†)6528	65 x 28 x 20	72 x 35 x 29½	21.1	3,028 / 3,206	4	28	64	61½
(†)7236	72 x 36 x 23	79 x 43 x 32½	34.5	4,000 / 4,270	4	36	80	72½

*Add 2" to outside depth for handle, dial and hinge projection.

**Model 1814 cannot be equipped with an auxiliary lock, 3-way boltwork or glass relock mechanism.

(†) Add CE for TL-15, CF for TL-30.



Custom AMVAULT escutcheon plate, shown with optional auxiliary key lock and pull handle, with matching operating handle.

*Tri-spoke handle standard on all models.

Underwriter's Laboratories' Burglary Rating Classification

U.L. Label — Burglary Classification TL-15:

Signifies a combination-locked safe designed to offer a limited degree of protection against attack by common mechanical and electrical hand tools and any combination of these means.

Construction Requirements

- U.L. listed Group II, 1 or 1R combination lock.
- 750 lbs. minimum or comes with instructions for anchoring in a larger safe, concrete blocks or on the premises where used.
- Body walls of material equivalent to at least 1" open hearth steel with a minimum tensile strength of 50,000 P.S.I.
- Walls fastened in a manner equivalent to continuous 1/4" penetration weld of open hearth steel with minimum tensile strength of 50,000 P.S.I.
- One hole 1/4" or less, to accommodate electrical conductors arranged to have no direct view of the door or locking mechanism.

Performance Requirements

Successfully resist entry* for a net working time of 15 minutes when attacked with common hand tools, picking tools, mechanical or portable electric tools, grinding points, carbide drills and pressure applying devices or mechanisms.

U.L. Label —Burglary Classification TL-30:

Signifies a combination-locked safe designed to offer a moderate degree of protection against attack by common mechanical and electrical hand tools and any combination of these means.

Construction Requirements

Same as TL-15

Performance Requirements

Successfully resist entry* for a net working time of 30 minutes when attacked with common hand tools, picking tools, mechanical or portable electric tools, grinding points, carbide drills and pressure applying devices or mechanisms, abrasive cutting wheels and power saws.

* Entry=Safes classed as TL-15 — opening the door or making a six square inch opening entirely through the door or front face. Safes classed as TL-30 — opening the door or making a six square inch opening entirely through the door or front face.

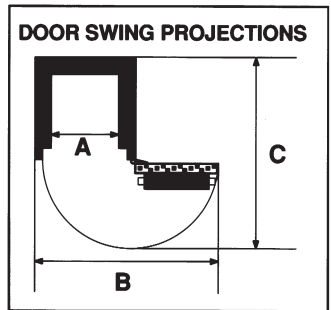

CE SERIES



CF SERIES





AMERICAN SECURITY PRODUCTS COMPANY

Optional Extras

AMSEC offers a wide variety of options not listed here. Consult your AMSEC price book or call for other available options. AMSEC's staff will also assist in helping you choose the correct options for your security needs.

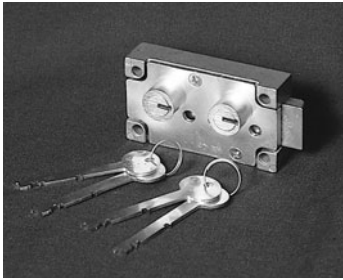

U.L. Listed Dual Nose Key Lock

U.L. Listed Dual Nose Key Lock

Dual control safe deposit lock requires two different keys to open safe.

Modular Alarm System

Detects vibration, heat and door openings. Heat indicator activates alarm when torch attack occurs. Internal magnetic door contact detects door opening. Internal vibration sensor activates alarm if safe is moved or during drill attack.

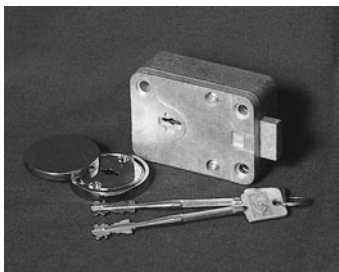

High Security U.L. Listed Key Lock

U.L. High Security Key Lock

European style nine-lever changeable key lock offers exceptional security features for use on inner locker or outer safe doors.

144 Hour Time Lock

Safes equipped with Time Locks offer the capability of locking the safe for a pre-selected period of time. Time periods range from one hour to 144 hours (6 full days).

U.L. Listed Key Op Lock

European style seven-lever changeable key lock offers exceptional security features for use on inner locker or outer safe doors.

Interior Drawers

All drawers are commercial quality, heavy steel construction. Available in letter, legal and document sizes. Each is furnished with handle and key lock. All drawer capacities are 150 lbs. and come with a heavy duty latch removable ball bearing suspension.

Key Locking Front Read Dial

Key is used to lock dial in a fixed position and affords dual custody control. Manager has the combination, collector has the key. Both must be present to unlock the safe.

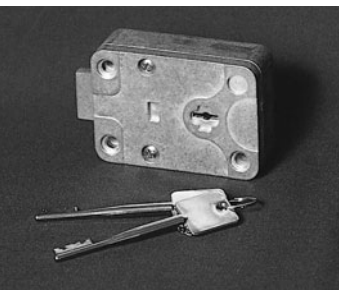

U.L. Listed Key Op Lock

Spyproof Dial

Restricts unauthorized viewing while dialing combination. Also available with key locking feature.



Spyproof Dial



144 Hour Time Lock



Key Locking Front Read Dial



Modular Alarm System



Interior Drawer

AMERICAN SECURITY PRODUCTS COMPANY

Optional Extras

Interior Lockers

AMSEC offers a wide variety of standard interior locker compartments to fit your needs. Standard lockers are constructed of 10 gauge or 1/4" solid steel. Options include slotted doors, combination locks and high security key locks.

Interior/Exterior Hopper

Available in three different package sizes ranging from 5-3/4"D x 3-1/2"W x 8-3/4"L to 7"D x 4-1/2"W x 10-3/4"L. Hoppers can be installed on the interior or exterior of plate, clad or composite safes.

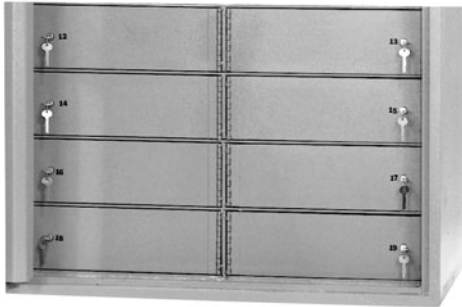

Interior Lockers

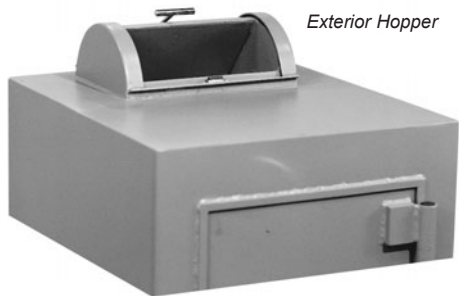

Exterior Hopper

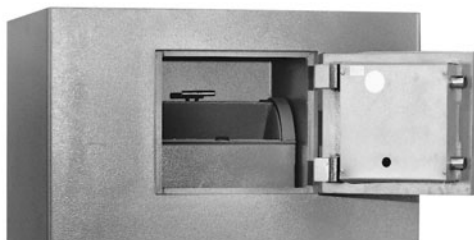

Interior Hopper

Locking Bolt Detent

Keeps locking bolts retracted when door is in open position. Prevents damage to safe body and boltwork mechanism caused by accidental door closure with bolts extended.

Coin Racks

For organized storage of coins. Mounted on inside safe door. Available with four or six compartments.

Slotted Doors

Slotted doors are also available on free-standing plate safes, freestanding clad, composite chests, interior lockers and interior drawers.

Note: Safes with slotted doors are not recommended for overnight storage.

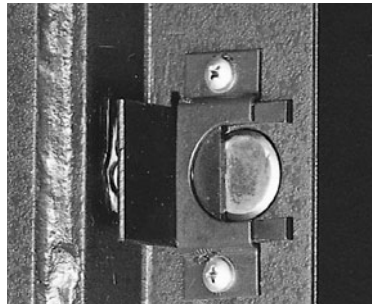

Locking Bolt Detent

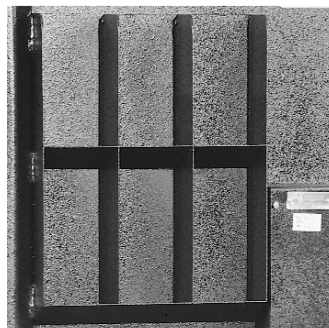

Coin Racks



STAR® "C" Rate Slotted Round Door with 3/8" x 3-1/2" slot.

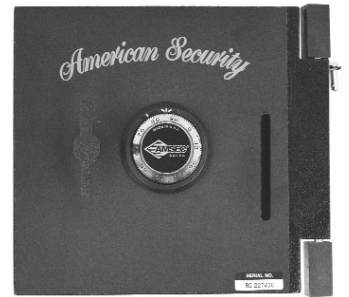

SUPER BRUTE "B" and "CB" Rate Slotted Square Hinged Door with 3/8" x 4" slot.

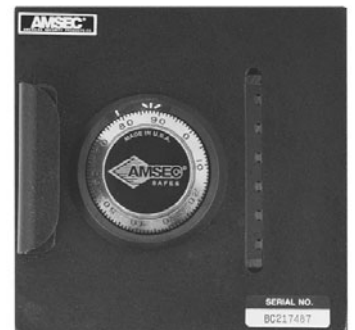

MINI BRUTE "B" Rate Slotted Square Lift-Out Door with 3/8" x 4-1/2" slot.



AMERICAN SECURITY PRODUCTS COMPANY

Teller Lockers

TELLER LOCKERS



BANK SAFES

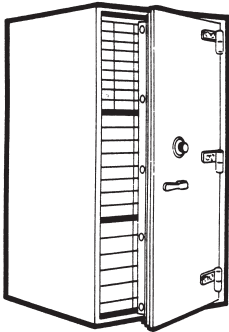

Teller Safe (Separate Teller Lockers also available)

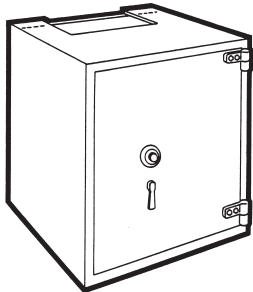

Night Depositories to accept your depository head

VAULT DOOR

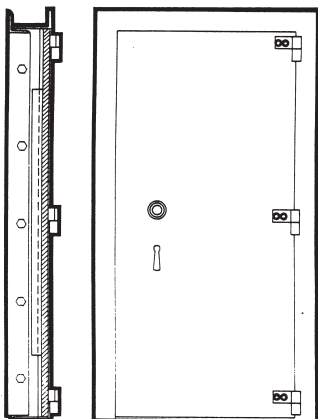

Vault Door: B Rate to TL-30 High Security Construction available

Features:

Body:

- 16"H x 32-5/8"W x 24"D, 1/4" solid steel construction.

Door:

- 1/4" solid steel, hinged from center, divider.

Hinge:

- Solid steel continuous hinge.

Color:

- Available in Gray, Blue Gray, Parchment, or standard Charcoal Gray textured finish.

Locks:

- U.L. listed double nose and single nose safe deposit locks or Medeco® camlocks standard. Combination locks optional extra.

Teller Locker Options

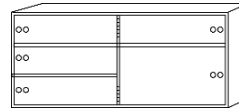

ATL-5R, Wt. 285 lbs.

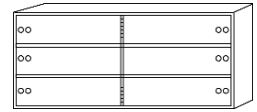

ATL-6, Wt. 295 lbs.

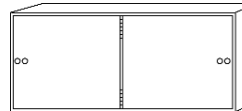

ATL-2, Wt. 240 lbs.

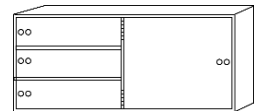

ATL-4R, Wt. 270 lbs.

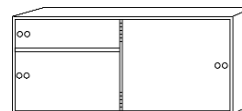

ATL-3R, Wt. 255 lbs.

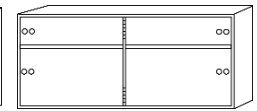

ATL-4, Wt. 270 lbs.

Custom Safes

AMSEC specializes in manufacturing custom safes for supermarkets, banks, restaurants, convenience stores, gas stations, hotels, mini-marts and other businesses. With over 50 years experience building custom safes, AMSEC has the knowledge and expertise to design a safe to meet your cash handling requirements. Our engineering department is equipped with the latest in computer-aided design (CAD) systems for rapid creation of detailed sales sketches, concept drawings, final product prints and design modifications to help you visualize how the safe will look and function. Custom safes are available in every insurance classification from "B" Rate to U.L. listed TL-30 models.



SPECIAL CONSTRUCTION

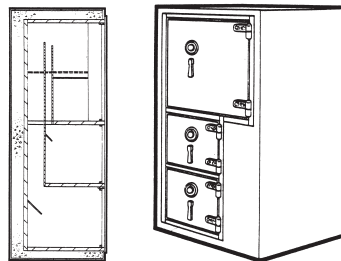

Supermarket Safe

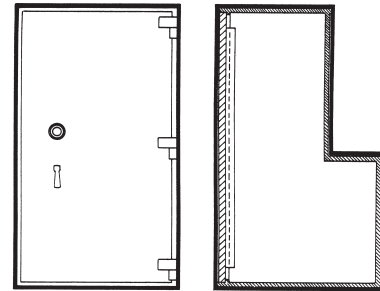

"Missouri Mule"

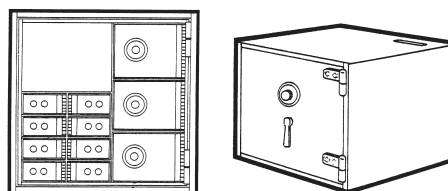

Restaurant/Hotel Safe

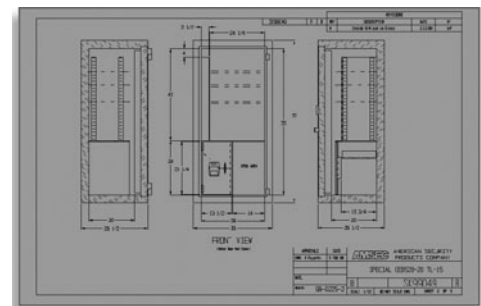

Example Sales Sketch

AMERICAN SECURITY PRODUCTS COMPANY

ESL Series Electronic Safe Locks

AMSEC has been a pioneer in the electronic lock market. The ESL series locks offer unrivaled value in electronic safe access. The ESL10 and ESL20 locks have the best blend of features and function in Electronic Safe Locks. The ESL10 is a basic keypad lock for home and office applications. The ESL20 offers advanced features necessary for commercial applications.

ESL10

Features:

- Replaces most mechanical combination locks. Easy installation and operation.
- Combination changes are fast and easy from the keypad.
- Factory Reset Combination for solving lost combinations without requiring expensive service calls.
- Two 9V-DC batteries in the keypad housing can be changed easily.
- Electronics are encapsulated within the lock and are sealed to prevent possible moisture related failures.
- Cable fits through a 1/2" spindle hole without cutting and re-crimping connector.
- Audible beep and flash from every key-stroke gives maximum feedback to the user.
- New industrial "Soft Touch" membrane keypad is tough yet requires very low activation pressure.
- 15 minute Penalty Lockout after four incorrect entries protects against manipulation attempts.
- New patented dead-latched lock design with an internal relock device for maximum security.
- Lock "auto-locks" when boltwork is thrown to prevent safes from being left in a day lock position.
- Optional internal battery pack extends operation between battery changes.
- Slam Bolt version for locker applications.

ESL20 Additional Features:

- **Time Delay Mode:** Delays can be set from 1 to 99 minutes. Open period can be set from 1 to 9 minutes.
- **Multiple User Mode:** When enabled, one Master code and eight user codes are available with full supervisory control and code management.
- **Dual Control Mode:** When enabled, the lock requires two combinations to open for added security.
- **Armored Car Override:** When enabled, allows an armored car service to bypass Time Delay.
- **External A/C Power:** Provides power for unlimited use with battery power as backup.
- **Control Port:** Turn the ESL20 on/off with an Access Manager, Alarm System or other device.

Optional Expansion Modules:

Provides these additional capabilities on the ESL20:

- Duress (Silent Signal) Alarm Output. Provides relay output for alarm system connection.
- External connection for A/C power transformer on ESL20 and ESL10.
- External connection for control port.
- Provides for connection of one or two ESL20 locks.

INSTALLED OPTIONS / RETROFIT KITS

Model	Description	Primary Lock Part No.*	Aux. Lock Part No.**	Retrofit Kit Part No.
ESL10	ESL10 Standard Lock	4505317	4505317A	0615226
ESL10S	ESL10 Slam bolt Lock	4505318	4505318A	0615227
ESL20	ESL20 Standard Lock	4505319	4505319A	0615228
ESL20S	ESL20 Slam Bolt Lock	4505320	4505320A	0615229
ESLBAT	Auxiliary Battery Pack for ESL10 or ESL20	4505321		0615230
ESL20EXP1	Expansion Module Kit for 1 ESL20 Lock	4505322		0615231
ESL20EXP2	Expansion Module Kit for 2 ESL20 Locks	4505323		0615232
ESL20EXP3	Expansion Kit, Duress Only	4505350		0615312
ESLAC	A/C Power Kit for ESL20 or ESL10	4505324		0615233
ESLTFMR	A/C Transformer for ESL20EXP 1/2	4505325		0635080

*Lock factory installed in place of the standard mechanical Combination Lock, Dial and Dial Ring.

**Lock factory installed as an auxiliary lock, includes all mount pads and hardware for installation.



ESL10

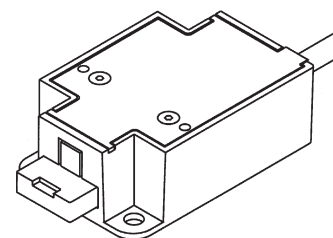

Standard Bolt

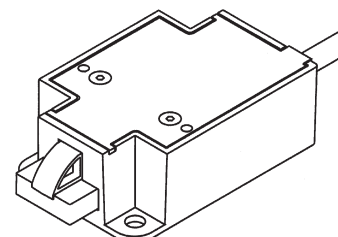

Slam Bolt



Type 1 Listed

All the ESL20 features are programmed from the keypad. The Expansion Modules provide convenient screw terminal and slip spade connections for field wiring by the installer.

A/C Power can be connected to the ESL20 and ESL10 lock (with the ESLAC kit) or an Expansion Module (with the ESLTFMR kit). Wiring, conduit and attachment hardware is provided with all optional kits.



The SafeWizard®

We are now quoting the AMSEC "SafeWizard®" electronic access control system on new AMSEC safes.

Retro-Fit Kits Available



The SafeWizard® electronic safe controller is a state-of-the-art electronic product for use in controlling and auditing access to safes. Designed to prevent burglaries and internal theft, the SafeWizard® controls and documents each access to the safe. Based on contemporary high speed processors, unique user friendly software techniques and ingenious application ideas, this system surpasses all other safe access control systems.

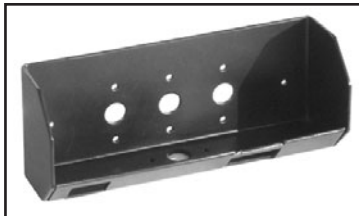

Safeguard



Dallas Key

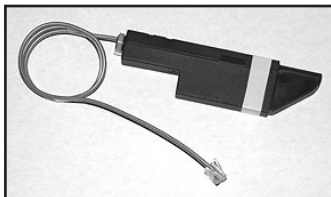

Door Sensor



Card Swipe Reader



Fingerprint Reader

The SafeWizard® Features:

- A powerful processor based on the ColdFire® 32 bit microprocessor.
- Flash Memory for quick and cost effective upgrades.
- Up to 10,000 audit entries and 40 users.
- Controls up to 6 safe doors and 1 deposit lock. Safe doors can be configured in any inner-outer arrangement. Man Trap feature to maintain security in a safe room so the Entry Door and the Safe can't be opened at the same time.
- Time Delay any door with a 1-99 minute delay and 1-99 minute open period with cancel feature.
- Time Lock any door, 1-6 windows per day.
- Authentication options: PIN code and/or Dallas Key access control, optional Finger Print Reader or Card Swipe devices are available.
- Dallas Keys are color-coded: Factory Key (Black), Audit Key (Yellow), Manager Key (Red), User Key (Blue) and Courier Key (Teal).
- Wrong Try Count Penalty Lockout.
- Auto-Purge Idle Users option, selectable by Individual User.
- Forced PIN Changes to decrease risk of compromised PINs.
- Armored Car courier Time Delay and Lock Bypass.
- Duress/Hold-up Alarm with Silent Signal.
- Burglary Alarm output triggering from selectable events.
- Holiday Schedule with up to 16 programmable events per year.
- Automatic Daylight Savings Adjustment, selectable and configurable.
- Dual Control Mode on any individual door, selectable by user.
- Built-in key maker, complete with management tool set, audit trail sorting by several criteria.
- Deposit Tracking system to provide the highest level of cash management security.
- Communications possibilities are unrivaled. Incorporating a built in Infra-Red (IR) Port, Multiple Serial Devices, optional Modem Communications Port and Ethernet Networking Port. Audits and administration can be managed through the Serial Port of Personal Computer or remotely via a Network and/or Modem connection.
- Audit trail can be downloaded to a Windows CE® based palmtop via the IR Port for compact and portable administration.
- Audit utility allows PC based audit storage management, data filter and sorting capabilities and excellent exception reporting to focus on key security issues.
- Ultra-high contrast 8 line by 21 character graphics display.
- Rechargeable Battery Backup.
- Built-in System Diagnostics.
- Alarm Interfaces in the Power Supply Module interfaces the system to any conventional Alarm System, with simple connections for Alarm Output, Duress Output, CCTV Activation and an Input for Alarm System control of the SafeWizard system.
- Parallel Printer Interface.
- English and Spanish language options.

AMERICAN SECURITY PRODUCTS COMPANY

Electronic Time Lock Control Device



The Access Manager® is not a lock by itself, but an electronic time lock control device. When controlling the ESL-20 electronic lock, it allows the user the capability of setting the system to their specific needs. The Access Manager® will control one or two electronic

locks. One lock operation allows four open time periods during a 24 hour period. If two locks are to be controlled, user may program two open time periods per lock, during a 24 hour period.

Easy Installation / Operation

- Eight conductor phone communication.
- All mounting hardware and cable included for normal installation.
- Retrofittable to the AMSEC/Major Defender Time Delay Lock.
- Works with most electronic locks.
- Easy to read illuminated display.
- 24 hour clock, military format.
- Alarm clock style programming.

Security

- Internal key control for programming.

Multiple Power Sources

Keeping in mind every possible situation the commercial environment can demand, AMSEC has made several different power sources standard.

- AC wall mount transformer.
- 4 AA battery back-up.
- On board Ni-Cad battery backup
- Auxiliary emergency power port on display board.



Access Manager



SARGENT AND GREENLEAF

A lock on security.

For detailed specifications, visit:
www.sglocks.com

COMPTRONIC™ Electronic Safe Locks

Standard features on all COMPTRONIC™ Electronic Safe Locks:

- All Combination changes and programming are easily made at keypad.
- Uses two (2), 9V Alkaline batteries -Duracell® recommended. (E-Z keypad uses (1) 9V battery.)
- Keypad feedback with beep and LED flash.
- Multiple users.
- Programmable Time Delay.
- Motor driven bolt.
- Wrong combination try penalty.
- U.L. Type 1 listed.

COMPTRONIC™ Keypad Finishes:

- Chrome - satin or bright
- Brass - satin or bright
- Black - matte only
- Gold - 14K or 24K

Optional Security Enhancement Accessories:

- Spy-Proof® Cover.
- Time Delay Status Indicator.
- Bolt Position Indicator.
- Duress and Remote Activation Modules.
- Audit Trail (Model 6124/25 only).



S & G 6120 Round Keypad



S & G 6120 E-Z Keypad

Kaba-Mas AUDITCON® Lock Series

Featuring **POWERSTAR** Technology: Use of an internal generator creates all the necessary power. No batteries or external power is required.

The Model 52 Series:

- Stand-alone, single combination access control.
- Dual Mode (2-user) function that provides a small business or individual with the convenience of electronic locking.
- Model T52 meets all specifications of the Model 52, plus is fitted with a time delay feature.

The Model 252 Series:

- Offers advantages of basic electronic locking.
- Programmable keypad with resettable combinations.
- Time Delay.
- Multi-user access control with audit capability.
- Audit Software Extra

The Model 552 Series:

- Easily replace traditional mechanical Group I and Group II locks.
- Upgrades the security of any safe or archive storage unit.
- Perfect for security applications where shared access and audit capability are necessary.
- Audit Software Extra



For detailed specifications, visit:
www.kaba-mas.com



AUDITCON Round Profile



AMERICAN SECURITY PRODUCTS COMPANY

LA GARD INC. Electronic Safe Locks

LAGARD

For details specifications, visit:
www.lagard.com



LG BASIC



SAFEGARD



SMARTLINC

LG BASIC ELECTRONIC LOCK

Standard Features:

- Manager Mode.
- Wrong Try Penalty.
- Outside Battery Compartment (Located under input housing).
- Uses one (1) user-supplied 9V Alkaline Battery.
- Satin-Chrome Angular Input Housing (Brass Optional).
- U.L. Listed.
- Made in USA.

Part # 3710 Angular Round Entry
Part # 3765 Dual-Handed Swing-Bolt

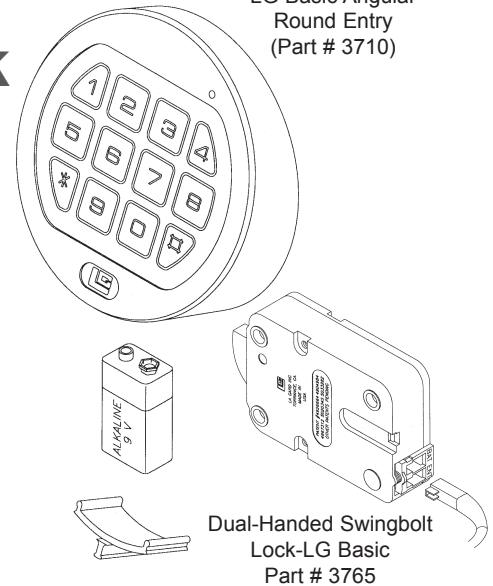

LG Basic Angular Round Entry (Part # 3710)

Dual-Handed Swingbolt Lock-LG Basic Part # 3765

SAFEGARD Digital Combination Lock

Standard Features:

- Direct Replacement - Most Mechanical Combination Locks.
- Wrong Try Penalty.
- Optional Features: Programmable at any time by **Authorized Service**.
- Uses user-supplied 9V Alkaline Batteries.
- U.L. Listed.
- Made in USA.

Programmable Features: (with Optional Hand-Held Programmer)

- Second user.
- Time Delay
 - Delay Period: 1-99 minutes
 - Open Period: 1-19 minutes
- Time Delay override.
- Dual Combination.
- Silent Signal Alarm
 - Optional box required
- Remote Override Signal
 - Optional Alarm box required

Part # 3600 Swingbolt Lock

SMARTLINC Serial Access Control

Standard Features:

- Wrong Try Penalty.
- Signal to Disable Lock
 - Optional Alarm/Battery Box Required
- System Status shown on LCD or optional printer.
- Audit trail by way of optional software
- Optional battery Box contains six user-supplied C-Cell Alkaline Batteries.
- U.L. Listed.
- Made in USA.

Programmable Features:

- Manager Mode
- Multiple users
- Dual Combination
- Time Delay
 - Delay Period: 1-99 minutes
 - Open Period: 1-19 minutes
- Time Delay override. (#9 osev)
- Silent Signal Alarm
 - Optional box required
- Time Lock set, 4 standard lock periods per day. (Special events takes precedence over Standard Week).
- Languages: Manager LCD display in English, Spanish, French, German or Italian.

Electronic Lock Comparison Chart



Access Manager
ESL-10
ESL-20

Safewizard®

6120
6123
6126

LGBASIC

SAFEGARD

SMARTLINC

AUDITCON52

AUDITCON252

AUDITCON552

VINDICATOR® II

	Round	Rectangle	Rectangle	Round	Round	Round	Round	Round	Round	Rectangle	Round, Verticle	Round, Verticle	Round, Verticle	Rectangle	
Housing															
Number of Users	1	8	N/A	40	8	5	1	1	1	1	1	2	20	99	60
Safe Doors	1	1	N/A	6	1	1	1	1	1	1	1	1	1	1	5
Power Source	(2) 9V/AC	(2) 9V/AC	AC with Battery Back-up	AC with Battery Back-up	(2) 9V	(2) 9V	(2) 9V	(2) 9V	(2) 9V	(2) 9V + (6) "C" (Opt.)	Self Generating/ Battery	Self Generating	Self Generating	Self Generating	AC with Battery Back-up
Combination (number of digits)	6	6	N/A	Key +6 8 if Keypad only Fingerprint +6 Card +6	6	8	8	8	8	6	6	6	6	8	Key + 4
Open Window (time/by user)	N/A	N/A	YES (by user)	1-99 min.	2 min./ fixed	2-9 min.	1-10 min.	1-10 min.	1-19 min. factory set	1-19 min.	YES	YES	YES	NO	1-255 min.
Wrong Try Lock Out (time)	YES	YES	N/A	Settable	4 (15 min.)	4 (15 min.)	5 (10 min.)	1-99 min. factory set	1-99 min. factory set	YES	YES	YES	YES	YES	YES
Dual Mode	N/A	YES	N/A	YES	NO	YES	YES	NO	YES	YES	YES	YES	YES	YES	NO
Time Delay	N/A	1-99 min.	N/A	1-99 min.	1-9 min.	1-99 min.	1-99 min.	1-99 min.	1-99 min.	1-99 min.	1-99 min.	1-99 min.	1-99 min.	1-99 min.	0-255 min.
Time Lock (periods) *(variable)	N/A	N/A	1	(6) (*)	N/A	N/A	N/A	N/A	N/A	(4) (*)	N/A	N/A	N/A	N/A	(5) (*)
Audit Trail (# of events)	N/A	N/A	N/A	8000 w/ 500 Backup	NO	NO	Time & Date (600)	NO	NO	YES (500)	NO	NO	YES 100	YES 400 Time & Date	5000
PC Software Audit Records	N/A	N/A	N/A	(OPT)	NO	NO	(Opt) Audit Only	NO	NO	(OPT)	NO	NO	YES (Opt.) 100	YES (Opt.) 400	YES (Opt.) 5000
Alarm Interface	N/A	YES (Opt.)	N/A	YES	NO	NO	YES	YES (Opt.)	YES (Opt.)	YES (Opt.)	NO	NO	YES (Opt.)	YES (Opt.)	YES
Bolt Options Auto Lock	YES	YES	N/A	YES	YES	YES	YES	YES	YES	YES	YES	YES	YES	YES	YES
Spring Bolt/ Slam Bolt	YES	YES	N/A	YES	YES	YES	NO	NO	YES	YES (Opt.)	YES	YES	YES	YES	YES



AMERICAN SECURITY PRODUCTS COMPANY MATERIALS HANDLING EQUIPMENT

Provide a higher level of service to your customer with AMSEC's new line of moving equipment, giving you the capability to deliver and install any size safe -- quickly and safely!

The Versatile Moving System

The VMS is capable of many functions. It has the ability to climb a curb or a short set of steps and easily negotiate steep ramps, low doorways and high thresholds. The VMS can break-back a load easier than any other handtruck. Since the load always rolls on four wheels it maintains perfect weight distribution and control during the move. The operator never needs to hold or balance the VMS, eliminating the danger of dropping the load, therefore providing protection to both the operator and the load. The unique padding system of cast polyurethane will not mark or mar. Rugged powder coated finish. 9000 lb. capacity ratchet with 2" nylon web strap.

Capacities up to 1800 lbs.

30 Day Manufacturers Warranty



Model 1800VMS

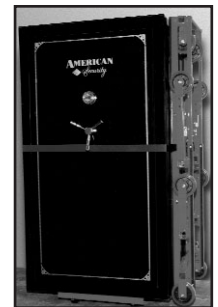

Model 1500LNR

Lift 'N' Roll

- Load is always stable and balanced.
- The hydraulic rams allow easy raising and gentle lowering of load from 1/8" to 4 1/2".
- Non-marking polyurethane wheels and padding system.
- Two handles on each side provide ease of maneuvering.
- Lightweight design. Built to last.
- Sturdy steel construction.
- Capacities up to 1,500 lbs.



UltraLift Powered Hand Truck

Designed to meet your on-the-job requirements, the UltraLift is the best move you will ever make.

Machine weight includes strap bar, 4-wheel dolly and spill-proof gel cel battery. Minimum overall machine height is with extension handle retracted for moves in restricted areas. Maximum height is with handle fully extended for maximum leverage.

- Great versatility: Handle any load on the level, up and down the stairs, on and off trucks, over obstacles and many more.
- Light-weight aluminum stands up to years of rough use.
- The operator stays in control by using a combination of motor power, balance and leverage.
- One person can easily handle every load, even up and down the stairs, reducing labor costs.
 - Gentle handling eliminates bumps and bounces to loads and premises, eliminating damages.
- Pay-off is approximately 21 installs (based on a national average of \$200 per install).
- Load capacity up to 1,500 lbs. Machine weight is 120 lbs.



Model 1500L

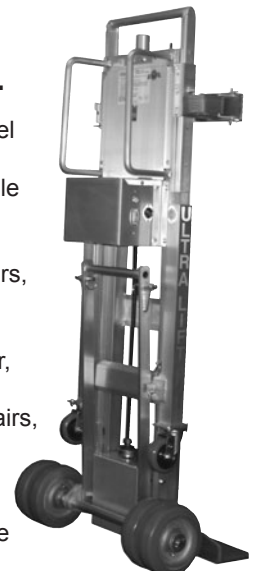

AMERICAN SECURITY PRODUCTS COMPANY MATERIALS HANDLING EQUIPMENT

Triple L Trailers

The design of this patented, innovative trailer is the result of Premco's extensive engineering and testing procedures. Triple L Trailers offer the highest quality and best value of any trailer on the market!



Features:

- Heavy duty 4" x 10" tubular chassis - steel diamond deck plate supported by 4 tubular members running the full length of the deck to give complete wheel support for heavy loads.
- Level loading - deck remains level through out raising and lowering.
- Full width rear ramp angle allows easier loading.
- Hydraulic System activated by a single lever.
- Oversized deck bearings rated for 80,000 lbs. - each bearing greaseless and sealed.
- Automatic latch locks upon raising for added travel security.
- Battery, pump and motor are enclosed in a lockable compartment.
- Lockable tool box - ideal for storing chain binders, tie down straps, etc.
- Heavy duty adjusting tongue jack.

1 Year Manufacturers Warranty

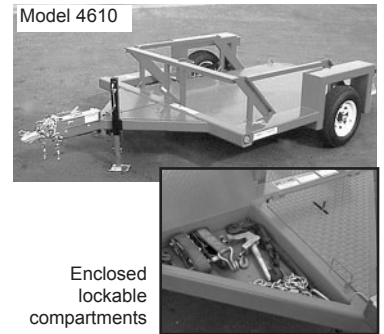
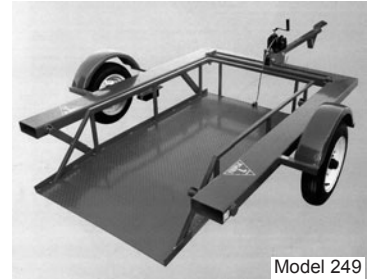

Specification Chart*		249	4610	7610
Model		249	4610	7610
Capacity (lbs.)		2000	4000	7000
Deck size		4' x 9'	6' x 10'	6' x 10'
Overall width		80"	101"	101"
Lift Mechanism		Winch	Hyd.	Hyd.
Axle		Single	Single	Tandem
Suspension		Torsion	Spring	Spring
Wheel Size		15"	14.5"	15"
Brakes		No	Elect.	Elect.
Hitch (ball size)		2"	2"	2-5/16"
Powder paint		Yes	Yes	Yes
Color		Charcoal	Charcoal	Charcoal
Lights Std.		Yes	Yes	Yes
Tongue jack		Yes	Yes	Yes
Weight		1510	2070	2500

*Specifications and design are subject to improvement and may change at any time without notice.

Optional Extras



1.5v on-board automatic charger w/ indicator lights



Spare tire mounting bracket w/ wheel & tire



12v loading winch w/ remote control

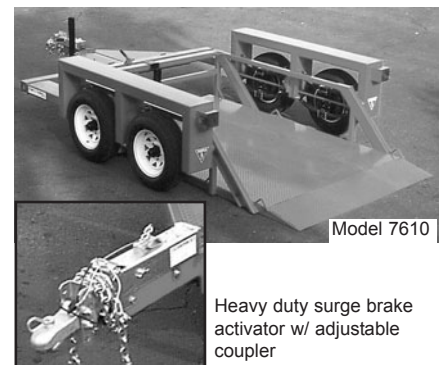

Heavy duty surge brake activator w/ adjustable coupler

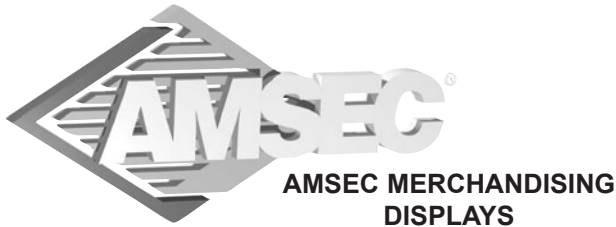

Part #	DESCRIPTION
3-PACK	SAFES: WS1014, WS1514, WS1214
1045008	Also includes display stand, POP, product tags, safe usage poster and consumer brochures
4-PACK	
1045020	4-Pack promotional kit: safe pedestal, sales banner, 3 hanging signs, safe usage poster, window decal, consumer brochures, product tags, & authorized dealer certificate
8-PACK	
1045021	8-Pack promotional kit: Large illuminated clock, two safe pedestals, sales banner, 4 hanging signs, safe usage poster, window decal, consumer brochures, product tags, & authorized dealer certificate

AMSEC INDIVIDUAL SALES AIDS

Part #	DESCRIPTION
1045022	Illuminated Clock
1045014	Display Pedestal
1045000	Sales Banner
1045024	'Burglary/Fire Safes' Hanging Sign
1045028	'Fire Safes' Hanging Sign
1045029	'Floor Safes' Hanging Sign
1045030	'Depository Safes' Hanging Sign
1015241	Authorized Dealer Window Decal
1045073	Guide to Safe Usage poster
4305126	Retail Price List
4305128	Guide to All Products Brochure
4305129	Product Catalog
4305172	Gun Safe Brochure
4305222	Gun Safe Mini-Brochure
1045072	Gun Safe Warranty poster
1045076	BF® Gun Safe Authorized Dealer Banner
1045075	BF® Gun Safe Brochure Holder
1045058	BF® Door Cut-Away Plaque
1045071	BF® Body Cut-Away Plaque
1045070	AMSEC Color Panel Display
1045004	Magnetic Product Tags (9)
1045007	3 pack display only
1045074	AMSEC Promotional postcard



Two Sided Hanging Sign

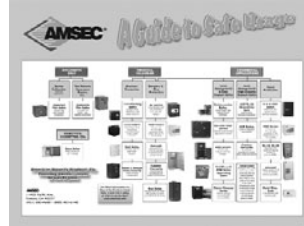

Guide to Safe Usage poster



Authorized Dealer Window Decal



3' x 5' Banner



Illuminated Clock (15" x 30")



BF Gun Safe Brochure Holder



BF Safe Door Cutaway



BF Safe Body Cutaway



THREE PACK DISPLAY



Safe Pedestal



Guide to All Products



Gun Safe Brochure



Product Catalog

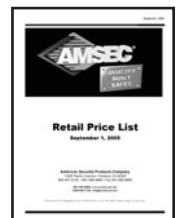

Price Book



AMERICAN SECURITY PRODUCTS COMPANY INDEX BY MODEL NUMBER

5517W25

A

ACF202030/31
ACF2020XD30/31
ACF302030/31
ACF3020XD30/31
ACF402430/31
ACF4024XD30/31
ACF4824DS30/31
ACF502430/31
ACF5024XD30/31
ACF603030/31
ACF6030XD30/31

B

B15004/5
B177
B18064/5
B18104/5
B18164/5
B1816D4/5
B22004/5
B247
B29004/5
B2900D4/5
B37004/5
B38004/5
B4004/5
B58004/5
B67
B7004/5
BD247
BDP247
BF151218
BF171618
BF211618
BF341618
BF603024
BF603224
BF604024
BF724024
BLB201815
BLB301815
BLB302415
BLB402415
BLC201815
BLC301815
BLC302415
BLC402415
BSW202010
BSW202510
BSW302010
BSW302510
BSW402010
BSW402510
BWB202011/14
BWB2020-D111/14
BWB2020FL11/14
BWB2020-S111/14
BWB2020-S211/14
BWB2020-S311/14
BWB2020TL11/14
BWB202511
BWB2025-D111
BWB2025FL11
BWB2025-S111
BWB2025-S211
BWB2025-S311
BWB2025TL11

BWB302011/14
BWB3020-D111/14
BWB3020FL11/14
BWB3020-S111/14
BWB3020-S211/14
BWB3020-S311/14
BWB3020TL11/14
BWB302511/14
BWB3025-D111/14
BWB3025FL11/14
BWB3025-S111/14
BWB3025-S211/14
BWB3025-S311/14
BWB3025TL11/14
BWB402011/14
BWB4020-D111/14
BWB4020-S111/14
BWB4020-S211/14
BWB4020-S311/14
BWB402511/14
BWB4025-D111/14
BWB4025-S111/14
BWB4025-S211/14
BWB4025-S311/14

C

C37
C57
C77
CB31122
CB41122
CD57
CD77
CDS3017CC13
CDS3017CK13
CDS3017KK13
CDXE28/29
CDXF28/29
CE181432/33
CE251832/33
CE352432/33
CE452432/33
CE552432/33
CE652832/33
CE723632/33
CF181432/33
CF251832/33
CF352432/33
CF452432/33
CF552432/33
CF652832/33
CF723632/33
CSC171717
CSC251717
CSC341717

D

DC2321
DC6221
DS15921
DS272021
DS432021
DS61221
DSC2014CK12
DSC2014CC12
DSC2014KK12
DSC2014KC12
DSF2014C12
DSF2014K12

DSF2714C12
DSF2714K12
DSF2731CC12
DSF2731KC12
DSF3214CC12
DSF3214KC12
DSF3214KK12
DSR201412
DSR271412
DST2014C12
DST2014K12
DST2714C12
DST2714K12
DST2731CC12
DST2731KC12
DST3214CC12
DST3214CK12
DST3214KK12
DXE28/29
DXF28/29

E

ES101320
ES111422
ES131020
ES41122
ES91322
ES913722

F

FS101320
FS131020
FS331620
FS412220
FS492220
FS572220
FS5737DD20

H

HC185425
HC1854HCC25
HR916E16
HRC916E16

K

K1/K28
KB6622
KB31122

L

LB121516
LP5924W25
LP6030W25
LP6032W25

M

MB115
MC1521
MM282013
MS1414C14
MS1414K14
MS1513D14

P

PB1/PB226

R

RV4115
RF652823

S

SB41222
SE683123
SW202026
SW302026
SW402026
SWPB126
SWPB226
SWVV101426

T

T4257
T6257
T625DD7
T9257
T925DD7
TB06108
TB0610-1T8
TB0610-28
TB0610-38
TB0610-48
TB0610-58
TB0610-68
TB0610-78
TB0610-88
TB06128
TB0612-1T8
TB0612-28
TB0612-38
TB0612-48
TB0612-58
TB0612-68
TB0612-78
TB0612-88
TB12108
TB1210-1T8
TB1210-28
TB1210-38
TB1210-48
TB1210-58
TB1210-68
TB1210-78
TB1210-88

U

UL151119
UL181219
UL1812XD19
UL201819
UL281819
UL391819
ULS151119
ULS181219
ULS1812XD19
ULS201819
ULS281819
ULS391819
US201514

V

VD803031

W

WES13109
WES21139
WFS13109
WS10149
WS12149
WS15149
WS18149

NOTES

NOTES

TEXTURED COLORS

Parchment

**Romanesque
Gray**

Gray

Blue Gray

Satin Black

Charcoal Gray

Granite

Sandstone

HIGH-GLOSS COLORS

Hunter Green

Burgundy

Onyx

Pearl

Platinum Finish



**AMERICAN SECURITY
PRODUCTS COMPANY**

11925 Pacific Avenue
Fontana, California 92337
800-421-6142 ■ 951-685-9680
Fax: 951-685-9685
Internet: <http://www.amsecusa.com>
E-mail: contacts@amsecusa.com